



**HAL**  
open science

## Passive and chipless packaged sensor for the wireless pressure monitoring in harsh environment

Julien Philippe, Cristina Arenas, Dominique Henry, Anthony Coustou,  
Alexandre Rumeau, Hervé Aubert, Patrick Pons

### ► To cite this version:

Julien Philippe, Cristina Arenas, Dominique Henry, Anthony Coustou, Alexandre Rumeau, et al.. Passive and chipless packaged sensor for the wireless pressure monitoring in harsh environment. Eurosensors, Sep 2017, Paris, France. 3p. hal-01570698

**HAL Id: hal-01570698**

**<https://laas.hal.science/hal-01570698>**

Submitted on 31 Jul 2017

**HAL** is a multi-disciplinary open access archive for the deposit and dissemination of scientific research documents, whether they are published or not. The documents may come from teaching and research institutions in France or abroad, or from public or private research centers.

L'archive ouverte pluridisciplinaire **HAL**, est destinée au dépôt et à la diffusion de documents scientifiques de niveau recherche, publiés ou non, émanant des établissements d'enseignement et de recherche français ou étrangers, des laboratoires publics ou privés.

## Passive and chipless packaged sensor for the wireless pressure monitoring in harsh environment

J. Philippe, C. Arenas, D. Henry, A. Coustou, A. Rumeau, H. Aubert, P. Pons

LAAS-CNRS, Université de Toulouse, CNRS, INP, Toulouse, France

### Summary

A new millimetre-wave passive and chipless packaged sensor for wireless pressure monitoring in harsh environment is proposed. This sensor uses a planar microstrip resonator coupled with a high resistivity silicon membrane. The remote interrogation of this sensor is performed from a Frequency-Modulated Continuous-Wave (FMCW) radar. Prototypes have been designed and fabricated using photoresist intermediate layer for the silicon membrane bonding. Radar measurements on two sensors validate a 6dB full-scale response for 1.4 bar overpressure. Depression measurements demonstrate the transducer hermeticity and a measured sensitivity of 1.6% per bar on the millimetre-wave resonant frequency.

### Motivation and results

Wireless, batteryless and chipless (without electronic circuit) sensors are a promising solution for the remote measurement of physical quantities in high radiation or extreme temperature environment or/and when the battery replacement is difficult or induces high costs. Electromagnetic sensors at millimetre-wave frequency are good candidates and the authors have demonstrated the proof-of-concept from several transducers [1] using Frequency-Modulated Continuous-Wave (FMCW) radar interrogation up to 58 meters [2-3].

In this communication, the authors focus on a practical application case in which pressure is monitored in nuclear plant building. The objective is to validate a packaged transducer that fits the pressure specification ( $\cong 1.4$  bar of overpressure) and operates in the frequency band of our radar (22.8GHz/24.8GHz). In our previous studies, we used a coplanar waveguide (CPW) microwave resonator whose resonant frequency was modified by the displacement of a silicon membrane. However, this configuration required a CPW-to-microstrip line transition (Figure 1) which creates undesirable spurious modes. By removing this transition we show here the possibility to reach a full-scale radar response up to 10dB (Figure 2).

The new design of the transducer with microstrip resonator is shown in Figure 3 and Figure 4. A 0.5 $\mu\text{m}$  thick aluminium layer is used to fabricate a half-wavelength coupled line resonator on a 500 $\mu\text{m}$  thick borosilicate glass wafer. A 100 $\mu\text{m}$  thick high resistivity silicon membrane is then bonded over the resonator using low-loss photoresist ( $\cong 10\mu\text{m}$  thick). This bonding solution allows a quite simple process providing a sufficient hermeticity for experimentally validating the prototype performances.

The simulated transducer response is given in Figure 5 where the resonant frequency shift is plotted versus the distance between the silicon membrane and the resonator. The electromagnetic simulation was performed assuming a planar silicon membrane deflection. For the full-scale pressure, a 9 $\mu\text{m}$  membrane deflection is expected leading to a resonant frequency shift of 9%. Transducers were fabricated using two different photoresist thicknesses (12 $\mu\text{m}$  and 3 $\mu\text{m}$ ) and allow validating a 6dB full-scale radar measurement range (Table 1).

Figure 6 shows the fabricated transducer inside its packaging. The reflection coefficient parameter  $S_{11}$  is measured in a controlled vacuum chamber in order to check the hermeticity of the transducer (Figure 7). Figure 8 shows that the resonant frequency shift depends quasi-linearly on the depression with a sensitivity of 1.6%/bar up to 1 bar. The next steps will be the radar measurements under overpressure indoor and then outdoor.

**Word count:** 488

### References

- [1] P Pons and al.: Electromagnetic transduction for wireless passive sensors, *EuroSensors, Sept 2012, Krakow, Poland*
- [2] H. Aubert and al.: Wireless Sensing and Identification based on RADAR Cross Sections Variability Measurement of Passive Electromagnetic Sensors, *Annals of telecommunications, vol. 68, no7-8, Aug 2013*
- [3] D. Henry and al.: Long Range Wireless Interrogation of Passive Humidity Sensors using Van-Atta Cross-Polarization Effect and 3D Beam Scanning Analysis, *IEEE International Microwave Symposium, June 2017, Honolulu, Hawaii*.

### Corresponding author

PONS Patrick, LAAS-CNRS, 7 Avenue Roche 31077 Toulouse, 05-61-33-64-63, ppons@laas.fr

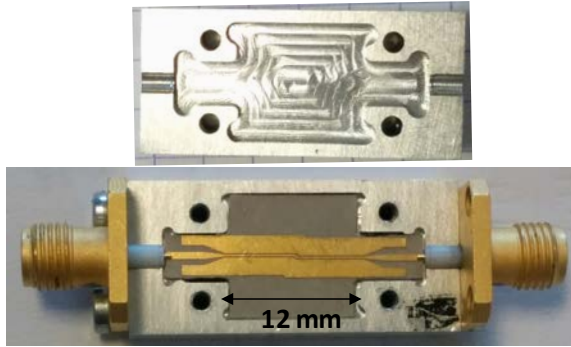

Figure 1: View of microstrip/CPW line inside the packaging (bottom) and packaging cover (top)

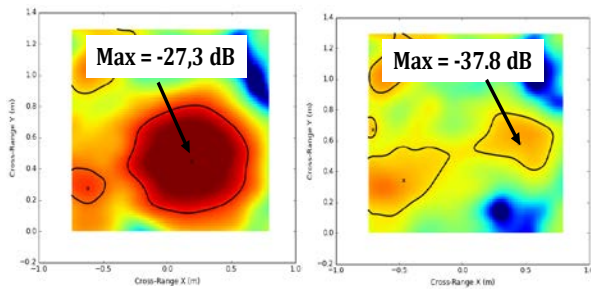

Figure 2: Cut-planes of a 3D millimeter-wave radar image obtained from a packaged 50Ω microstrip line loaded by a short-circuit (left) and by the 50Ω matched impedance (right)

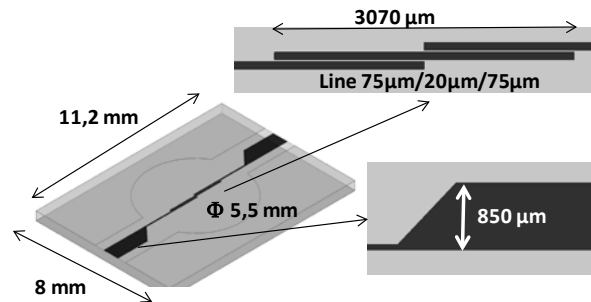

Figure 3: Dimensions of the microstrip planar resonator

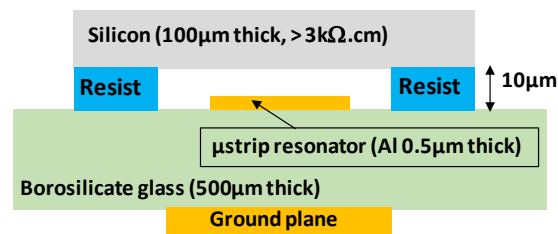

Figure 4: View of sensor layers

Table 1: Shift of the reflection coefficient  $S_{11}$  at the input of the planar resonator and radar echo amplitude between two [silicon membrane / resonator] distances (12μm and 3μm)

Shift of $S_{11}$ @ 23.8 GHz	4.8 dB
Shift of $S_{11}$ in [22.8GHz/24.8GHz] band	5.9 dB
Shift of radar echo	6.1 dB

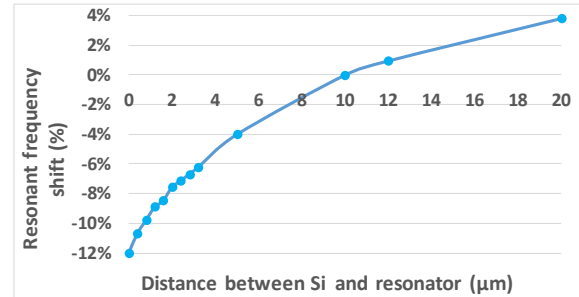

Figure 5: Simulated resonant frequency shift versus the distance between the Si membrane and the planar resonator

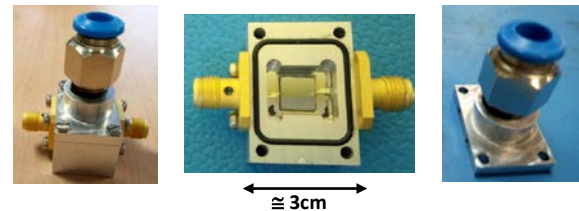

Figure 6: View of the packaged sensor

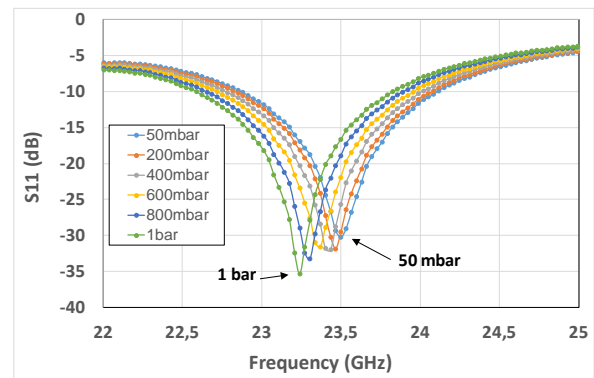

Figure 7: Measured  $S_{11}$  parameter versus frequency for various depressions from 50mbar to 1 bar

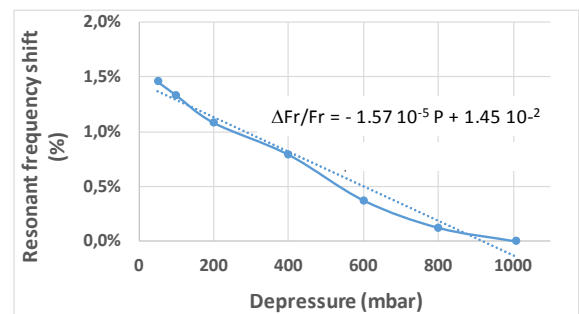

Figure 8: Measured resonant frequency shift versus depression

*Topic : Sensors for factory of the future*