



HAL
open science

Application of Systems Engineering in Distributed Control and Building Performance Applications

Azzedine Yahiaoui, Abd-El-Kader Sahraoui

► **To cite this version:**

Azzedine Yahiaoui, Abd-El-Kader Sahraoui. Application of Systems Engineering in Distributed Control and Building Performance Applications. 2012 IEEE 21st International Workshop on Enabling Technologies: Infrastructure for Collaborative Enterprises, Jun 2012, Toulouse, France. hal-01704797

HAL Id: hal-01704797

<https://laas.hal.science/hal-01704797v1>

Submitted on 8 Feb 2018

HAL is a multi-disciplinary open access archive for the deposit and dissemination of scientific research documents, whether they are published or not. The documents may come from teaching and research institutions in France or abroad, or from public or private research centers.

L'archive ouverte pluridisciplinaire **HAL**, est destinée au dépôt et à la diffusion de documents scientifiques de niveau recherche, publiés ou non, émanant des établissements d'enseignement et de recherche français ou étrangers, des laboratoires publics ou privés.

Application of Systems Engineering in Distributed Control and Building Performance Applications

Azzedine YAHIAOUI

Center for Building and Systems,
Technische Universiteit Eindhoven,
Netherlands
a.yahiaoui@bwk.tue.nl

Abd-El-Kader SAHRAOUI

CNRS -LAAS ; 7 Avenue Colonel Roche,
Université de Toulouse ; UPS, INSA, INP, ISAE ;
F31077 Toulouse, France
sahraoui@laas.fr

Abstract: Building itself is like a complex system with a number of physical processes that interact with each other and with the environment. From the control point of view, this system is composed of multi dynamic subsystems that must be monitored and controlled in order to achieve occupants' well being and energy efficiency. However, environmental and occupants change in a building, and this increases the complexity in applying control systems. For this reason, this paper presents a comprehensive framework using the systems engineering (SE) concept – a systematic approach for adapting procedures, tools, and standards to all practical problems – in order to analyze and design effective integrated control solutions. Although these solutions are based on the use of SE good practice and corresponding SE standards, the development lifecycle of control systems are covered ranging from the operational needs to implementation, operation and disposal. As an essential step toward this goal, namely using computer simulations to evaluate the impact of advanced control systems on buildings operation and energy use, this paper describes a distributed simulation mechanism that was developed and implemented between different simulation tools such as ESP-r and Matlab/Simulink. The paper also addresses a study of verification and validation (V&V) issues within this framework: inconsistency checking, traceability issues and all requirements related in SE standards, especially EIA-632

Keywords: *systems engineering, distributed dynamic simulation, control modeling environment, building performance simulation, verification and validation.*

I. INTRODUCTION

With today's environment changing concerns, the automation and control systems must be applied to buildings heating, ventilation, air-conditioning and refrigeration (HVAC&R) equipment and lighting components in order to reduce energy consumption and greenhouses gas effects while at the same time achieving occupants' well being and improving building performance operations. Such developments need to be designed, implemented and deployed rapidly in order to reduce time involved in improving building HVAC&R equipment and lighting components for new applications. Furthermore, it has been shown previously (see e.g., Yahiaoui 2008) that building performance applications are substantially influenced by the quality of automation and control systems provided in it. Therefore, the integration of advanced control systems in building environmental performance has for objective to

promote sustainable buildings as well as the development and the next generation issues of economic strategies. Sustainable buildings or "high-performance buildings", also called green buildings are buildings with complex systems, which should have minimum adverse impacts on the built and natural environment. One of the major challenges today is the protection of the ecosystem. Although the building is designed and constructed for a long period, the life cycle of this building can vary from some months to hundreds of years, the building. During the period of its usage, the building can progressively consume significant amounts of natural resources, produce large quantities of gas emissions and affect the ecosystem in many different ways. As a result, there is a need to apply advanced control systems in order to make buildings more sustainable and efficient while at the same time improving occupants' well-being and indoor operations as well as reducing their impacts on local and global environmental quality.

The dwelling aspects concerned with sustainable buildings are comfort, well-being and energy efficient of occupants. The history shows that the protection of human health, in which the ecosystem protection is associated with, is much more closely related to comfort problems (thermal and visual comfort and indoor air quality). For this reason, this paper presents a comprehensive framework using SE concept in order to early establish principles and requirements in the design of control systems. While recognizing that there are many other aspects involved in achieving lower energy consumption, greater satisfaction and higher productivity of the occupants, the work described in this paper, focuses on modelling and simulation for better control design of the indoor environment in buildings.

The benefits of integrating advanced control systems in building performance applications would consist of offering an enhanced functionality of building indoor operations and of building HVAC&R equipment and lighting components resulting in better buildings performance, as well as an improved reliability with further reduction in energy costs. To well-establish such a vast diversity of control functions for all the building HVAC&R equipment and lighting components that operates within the building environmental performance, it is necessary to take into account several factors, which may particularly include indoor environment variable (or processes), occupants' requirements, and economic parameters in the form of microeconomic and

macroeconomic levels. It is then important to mention that such sophisticated improvements would occur as a result of automated building HVAC&R equipment and lighting components (or more precisely, as the art of automating buildings). Therefore, automated building refers to the automation and control of building HVAC&R equipment and lighting components, which have been the subject of Building Automation and Control Systems (BACS) or Building Automation Systems (BAS) since last century.

However, a variety of simulation tools for building performance and energy analysis have been developed, ranging from the simple and estimated to the difficult and detailed use. Among them, a small number of programs have given up because they became either useless or too restricted. Even it is complicated to categorize the existing simulation tools since some of them integrate particular components while others incorporate other different components. Another issue is concerned with the building design, as many buildings gave up or demolished since their performances in energy use turned into disastrous. In (EERE 2006), it is pointed out that the energy consumption of new buildings can be reduced by as much as 50% with little or no impact on the cost of ownership through the use of SE concept. Therefore, the use of SE concept in the building domain would certainly provide a systematic approach to adapt procedures, tools, and standards toward an information-oriented problem in order to analyze, to design, to develop, to manage and to finally implement an effective and a pragmatic integrated solution, as shown in figure 1. Detailed specifications are translated into test procedures, design, and user documentation.

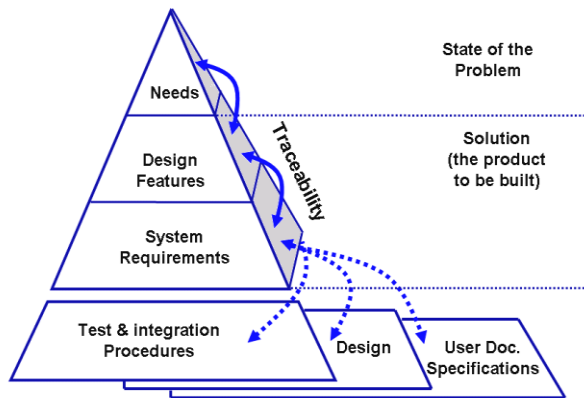

Figure 1. Approach based on managing the integration of control systems in building performance applications.

The remainder of this paper is organized as follows: the next section presents a brief description of context, problematic and state of the art. Then it follows the essential of SE concepts and design methodology process towards establishing a comprehensive framework. The third part concentrates on the development and implementation issues. This is followed with a demonstration of a building case study by preserving a balance between theoretical and practical aspects. The last part finishes with conclusions and perspectives for future work.

II. CONTEXT, PROBLEMATIC AND STATE OF THE ART

A. Context and Application

The context in this work is related to the development and implementation of advanced control systems in buildings, especially in building environmental performance. The integration of building science engineering, architecture, construction management and risk assessment for new construction projects and existing buildings becomes a must. Building applications require a lifecycle of development as shown in figure 2.

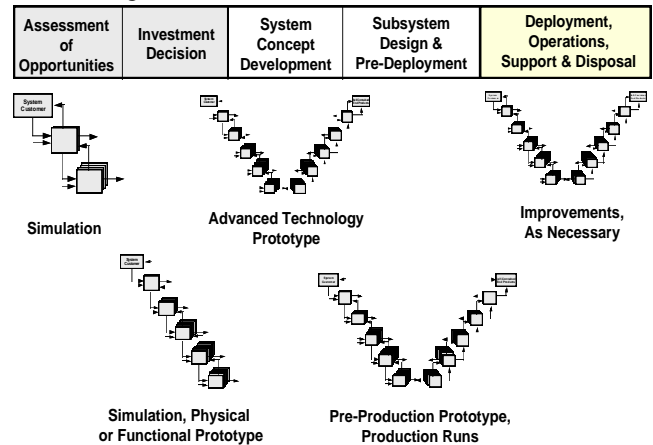

Figure 2. Enterprise-based life cycle phases.

In this context, this study is concerned from the systems development (including subsystems design and deployment operation) to the deployment operations concerning the multiple development and implementation of the initial systems as a final system or a prototype.

B. Problem Statement

There are numerous approaches to the integration of new technologies in the buildings domain. However, a comprehensive framework where a building is seen as a system is not yet industrialized. Such developments using SE practices require to define requirements ranging from users/stakeholders needs to institutions, standards, local, national regulations, etc., where the limit of such integration cannot be defined if a global approach is not used. For this reason, this work focuses on the problematic of integrating advanced control systems in building performance applications by using information technology (IT) tools to assist an optimal solution design.

C. State of The Art

Up to our knowledge, there are not yet establishment mythologies and approaches linking SE practices with the appropriate use of building HVAC&R (equipment lighting components). Nevertheless, some energy research departments in America, such as (EERE, 2006), use SE concepts to home buildings as advanced framing and insulation methods to increase efficiency and comfort while decreasing construction and energy costs.

III. SYSTEM ENGINEERING AND DESIGN METHODOLOGY PROCESS

A. Systems Engineering Process

SE practice is not new, but the discipline is. It started with large-scale programs in USA, mainly in aeronautics (see e.g. Mathers et al. 2000), in space (Shishko, 1995) and particularly in defense (see e.g. DSMC, 1990 and Hoang et al., 1996). Furthermore, it is getting popular in country having a well-established aeronautic and military industries; it has been since the 1990's deployed in manufacturing, automotive (Loureiro et al. 1999) and recently in Society of Manufacturing Engineers (SME) (INCOSE, 2010). As a simple definition: Systems Engineering (SE) is an interdisciplinary approach encompassing the entire technical effort to evolve and verify an integrated and life cycle balanced set of system people, product, and process solutions that satisfy customer needs. SE encompasses: (1) the technical efforts related to the development, manufacturing, verification, deployment, operations, support, disposal of, and user training for system products and processes; (2) the definition and management of the system configuration; and (3) the translation of the system definition into work breakdown structures Development of information for management decision making.

B. Systems of systems

The deployment of SE product can be carried out in a comprehensive approach by separating the final product (i.e., building) from the enabling product (i.e., HVAC&R equipment and lighting components, control systems, etc.) and development product (simulation tools, etc.) this can be best illustrated by the following figure 3.

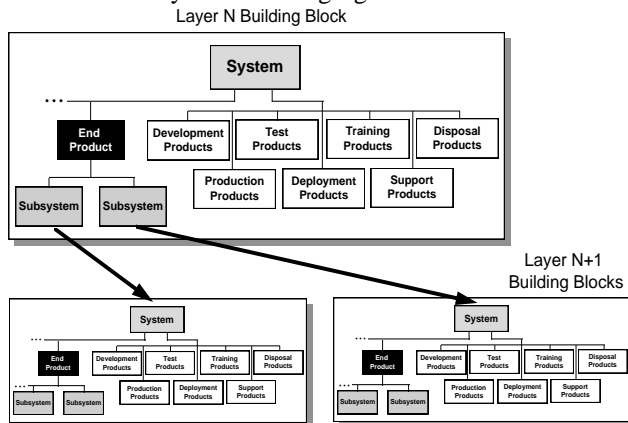

Figure 3. Hierarchy of building blocks.

A single block will really define the complete solution to a complex problem more typical of the design project. When an end product sub-system requires further development it will have its own subordinate building block. Once the descriptions of the end product of the initial building block are completed, and preliminary descriptions of the end product subsystems are defined, the development of the next lower layer of building block can be initiated.

C. SE Deployment and Standard

In order to deploy SE for a specific building application, it requires first to identify all subsystems contained in the final product (the building model) and subsystems that are part of enabling product for integrating building HVAC equipment and lighting components and their control systems. Although HVAC equipment, lighting components, elevators and/or escalators, and fire and security equipment are essentially integrated in automated buildings, the simulation and modeling tools used, in this context can play a principal role in enabling the current building model as a final product.

SE concept is a diagram that includes the known processes that are daily in use. However, there are many models of popular SE standards, such as: ISO-15288, ANSI/EIA-632, IEEE-1220, SP-6105, ECSS-E-10A, but certain phases of these diagrams are frequently similar to each other (Sheard et al. 1998). Although the objective of this research is to apply the deployment strategy to a building model, the EIA standard (EIA-632, 1998) is applied to the level concerned. While recognizing that the EIA-632 standard is applied in diverse industries with success, it is certainly well suited for developing strategies such as simulation, prototyping, and benchmarking for resolving uncertainties and optimization issues in the building design.

IV. DEVELOPMENT AND IMPLEMENTATION ISSUES

For the analysis and design of integrated control systems for building performance applications, a number of issues can be addressed, among them are the followings: 1) Although most building HVAC&R equipment and lighting components have been developed with an idea of improved performance, their developed control systems that regulate their capacities in buildings are basic and not established properly. As a result, it requires developing a systematic knowledge to make best use of their potential benefits through appropriate control systems of their performance characteristics under transient climatic conditions and occupants needs. 2) When building HVAC&R equipment and lighting components are used in a building, the simple addition of individual best performances does not warrant the best performance of the entire building. As a result, it is necessary to develop control systems through integrated SE concept in order to provide the maximum benefits to buildings. 3) When requiring to simulate a building performance application and its control system is that frequently certain building equipment and/or components can be modelled in one simulation software while some models are only available in other simulation environment. Consequently, there is on the one hand domain specific software for building performance simulation (BPS), which is usually relatively basic in terms of control modelling and simulation capabilities (e.g. ESP-r, TRNSYS). On the other hand, there exists a domain dependent for control modelling environments (CME), which is very advanced in control modelling and simulation features (e.g. Matlab/Simulink). One way to alleviate such a restricted issue is to reason behind the hypothesis that marrying the two approaches by

run-time coupling would potentially enable building performance assessments by analysing the overall effects of building operations (Yahiaoui et al., 2003).

A. Development lifecycle

The development lifecycle, in this study, includes several phases during which utilized software tools for BPS and CME must work together separately. In sub-system level, the last phase occurs when the study of the building model or the control system is disposed of and the task performed is either eliminated or transferred to the system level. The tasks and work activities for each phase are described below. The integrated control systems for building performance applications require that the phases of both the building model and its remote control system should be sequentially executed. However, the lifecycle diagrams concerned with both the building model and its remote control system are interdependent in which their phases may be combined and overlapped.

The SE concept, which specifies functions, sequence and the interrelationships between various phases of both the building model and its remote control system, is extremely imperative so that their integration into the same entity will be successful. Although, there exists several lifecycle diagrams (spiral, waterfall, V, etc.) that can be used for applications, the V diagram is probably the most popular one that is used for the application of SE concepts to the development of complex projects. The V diagram is based on the interactions that take place between the links of decomposition or analysis (\setminus) and construction, which means physical integration, or synthesis ($/$) of the design project (Yahiaoui et al. 2006a). When the cycle V is applied and contains all the components of the project, as shown in figure 4, the number of loops is easily deduced by decomposing and reconstructing the design concept.

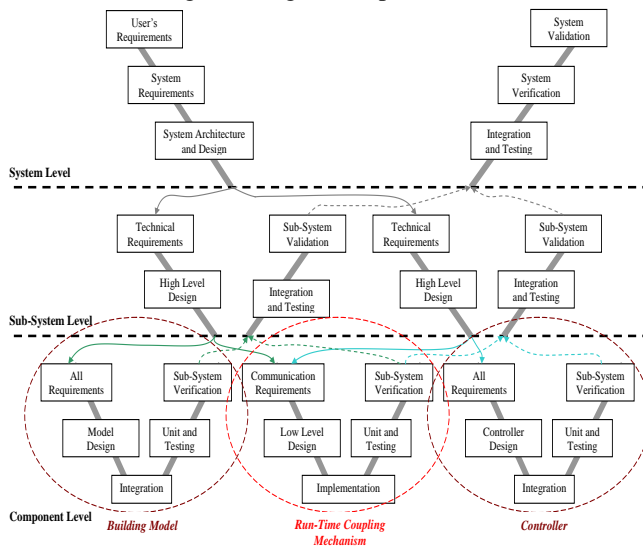

Figure 4. Development lifecycle model.

As indicated by Blanchard (1991), SE introduces the notion of top-down design, which involves viewing an entire system comprised of its components as a whole functioning

unit. This starts by identifying the sub-systems and then components of the system, decomposing them into low-level sub-systems and then lower-level components and iterating until the desired level of detail is achieved. By considering this notion of top-down design, the integration of control systems together with building performance applications can be viewed as the whole functioning unit of a building operation that is actually represented in the form of V diagram (so to the entire design process of the building operation). The SE concept to the analysis and synthesis of structural V diagrams focuses on the scope of the building operation along with a set of identified requirements engineering, especially functional requirements. SE concept can go one step further to establish further functions that are important to successfully design a proper control system for building performance application.

At top level, the building is represented in the total form of the V diagram, in which at low level this building consists of two sub-systems that stand for the building model and its remote control system, which at lower level are represented separately to work together by run-time coupling. As in BACS architecture, building HVAC&R equipment and lighting components are located in the field level and their control systems are located in the automation level, and they exchange data through a network. By similarity to BACS architecture, a distributed dynamic simulation mechanism was developed and implemented between BPS and CME in order to simulate building control applications, as happen in a real situation. While building models (including zones, HVAC&R equipment and lighting components) are built on ESP-r, their remote control systems are modelled on Matlab/Simulink. Both PBS and CME can run either on the same computer or on different computers connected by a network. In addition, both software environments should exchange data by run time coupling in order to obtain simulation results as accurate as possible. In consequence, there are three V diagrams at component level, as shown in figure 4, where the V diagram in between concerns run time coupling between a building model and its control system (Yahiaoui et al. 2006a).

B. Distributed Dynamic Simulation Mechanism

The most critical issues facing the design of run-time coupling between Matlab/Simulink and ESP-r include heterogeneity, interoperability, and parallelism. In previous work (Yahiaoui et al., 2003, Yahiaoui et al., 2004 and Yahiaoui et al., 2005), run-time coupling between ESP-r and Matlab/simulink was developed based on the development of an Inter-process Communication (IPC) mechanism using Internet sockets. This performs a distributed simulation using network protocols including transmission control protocol (TCP) and user datagram protocol (UDP) by exchanging data between building models and their control systems, as occurs in BACS architecture. Both a building model built on ESP-r and its remote control system modelled on Matlab/Simulink that are separated and work together by run-time coupling can be located on either the same host or different kinds of hosts to speed the simulation. Therefore, one of the main objectives of this distributed dynamic

simulation mechanism is not only to enable the integration of (advanced) control systems in building performance simulation by run-time coupling but also to be able to simulate building environmental applications that had been previously infeasible (i.e., yet impossible).

During simulation, commands and data are exchanged between a building model built ESP-r and its remote control system modeled on Matlab/Simulink at every time step. When a building model has to send the current measured (or sensed) data to its control system using TCP/IP-suite, a method is first called to encode data to exchange to network format. When a control system has to receive this current measured data from its building model, another method is also called to decode from network format to data received. The same procedures are executed when a control system has to send back the actuated data to its building model, and when a building model has to receive the actuated data from its control system. Therefore, both a building model built on ESP-r and its remote control system modeled on Matlab/Simulink running either on the same computer or on different computers connected to the network exchange data at every time step using the same procedures. Furthermore, the iteration continues with the same way until the simulation is completed. Figure 5 shows how a distributed dynamic simulation is implemented between ESP-r and Matlab/Simulink over a network.

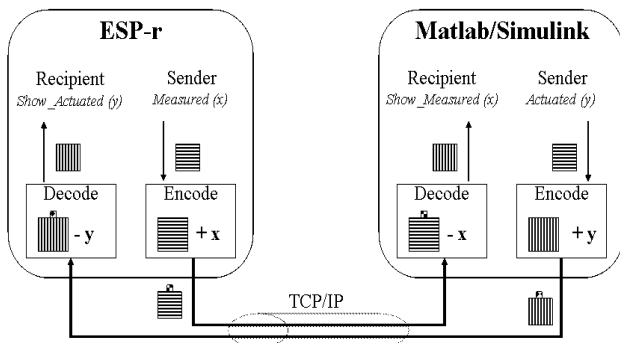

Figure 5. A distributed dynamic mechanism for building control and performance simulation.

In addition, this dynamic mechanism of distributed building control and performance simulation is also implemented to support data exchange in ASCII, binary, and XML formats as well as synchronous, partially synchronous and asynchronous communications modes.

C. Application of SE Practices in Design of Control Systems for Building Performance Applications

A very structured way of designing advanced control systems for building performance applications by run-time coupling between ESP-r and Matlab/Simulink is by involving SE practices in order to translate the occupant requirements (or need) into a control system specification and realization that most efficiently meets these needs. Figure 6 shows how to design an advanced control system through a simple V-diagram while applying SE principles.

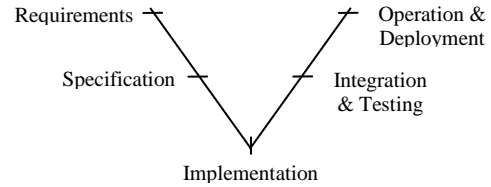

Figure 6. A well-established way of designing advanced control systems.

As shown in Figure 6, the V-diagram is simple because it consists of a small number of phases ranged from requirements to specification, implementation, integration and testing, and operation and deployment. The requirements phase defines the occupant needs and determines the building processes and/or dynamical models of plants to control and to be used for instance to derive requirements of the subsystem level of abstraction from requirements of the system level of abstraction. The specification phase identifies the goals and functionalities of the control systems, along with their inputs and outputs that must be selected to be run-time coupled with ESP-r. The implementation phase takes needs and goals of the previous phases and implements them using appropriate control systems. The integration and testing phase consists of integrating building and/or plant models built on ESP-r with their remote control systems modelled on Matlab/Simulink by run-time coupling and then testing if their inputs and outputs are connected correctly. The operation and deployment phase consists of calibrating the necessary control parameters to meet needs and running simulations.

V. CASE STUDY: BUILDING CONTROL APPLICATION

This case study concerns the test cell – an experimental room measuring 3.15*3.85*2.6 m³ located at Delft University of Technology (TU Delft) – that is built with light construction materials in order to investigate different phenomena that influence the indoor environment of passive buildings. These phenomena include infiltration, radiant or solar heat gain and heating loss gains. Figure 7 shows a complete representation of the test-cell (or test room) and its monitoring room. Whereas the test-cell is equipped with several sensors and actuators, as shown in figure 7 (left), its monitoring room contains a PC and a Data Acquisition, as shown in figure 7 (right). A PC is used for monitoring the actuators (i.e., HVAC equipment and lighting components) of the room by means of Matlab/Simulink, and a Data Acquisition that communicates with a PC by a remote control process and data transfer bus connecting to all sensors and actuators mounted in the test-cell. The objective of this case study concerns the analysis and design of control systems in building performance applications with two issues: The first consists of comparing between experimental and simulation results obtained by using the same building model and the same control system as well as the same time step of 1mn/hour. The second qualifies the importance of using a distributed dynamic mechanism between ESP-r and Matlab/Simulink to enable the integration of advanced

control applications in building performance simulation by run-time coupling.

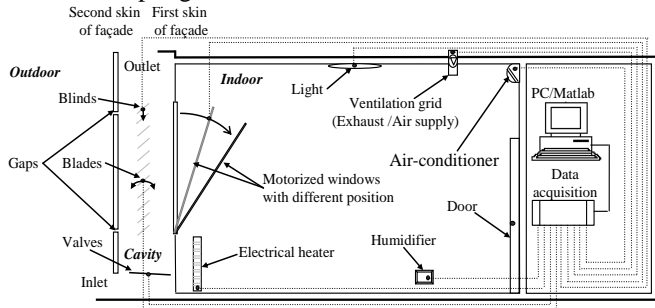

Figure 7. TU Delft test-cell application.

A number of thermal sensors are installed at different places inside and outside the test-cell and continuously measure the temperature around it. All measured (or sensed) values are read on PC through a developed user-interface of Test-Point at every interval of time. This time interval can be varied from seconds to minutes depending on the experimental work. Through this user-interface, all actuators in the test-cell can also be activated with a value varying from 0 to 100%. This activation can hold either manually or automatically. When it is set to automatically, all actuators are remotely monitored from Matlab/Simulink.

In this paper, the application of advanced control systems is only limited for heating and cooling processes of the test-cell, although it can be to all actuators including mechanical and natural ventilation, humidifier, electric lighting, and venetian blinds. This application concerns with the development and design of a hybrid control system, a reactive control system that intermix discrete and continuous components, to meet the occupants' requirements such as maintaining the indoor air-temperature within the heating and cooling set-points while at the same time reducing the energy use in a building (i.e., test-cell). Reducing the energy use in buildings would certainly reduce greenhouse gas effects. For this application, the heating plant is an electric heater of 1750 (W), the cooling plant is an air conditioner of about 60 (W). While the heating plant was set to operate when the indoor air temperature went below 22° C and to stop when the indoor air temperature reached 22° C, the cooling plant was set to operate when the indoor air temperature rose above 26° C and to stop when the indoor air temperature reached 24° C. As the experiments were performed during the winter, the indoor air temperature would not rise above 26° C, and therefore the experiments only concerned the heating process.

A requirements document for building heating process is well documented and described in (Booch, 1991) and (Hatley et al., 1988). With the modelling approach proposed in this paper, it demonstrates that the use of a system-level architectural design provides numerous advantages over traditional design methods. A number of limitations and/or shortcomings presented in traditional design methods using classical or conventional control systems can therefore be avoided. By using system-level considerations, control systems can be designed following the SE concept through

various abstraction levels. For this reason, it requires using a sequence diagram expressing all feasible interaction among objects by describing the behavior of the heating process in buildings. Figure 8 shows a simple example of a unified modelling language (UML) sequence diagram describing all scenarios of the building heating mode.

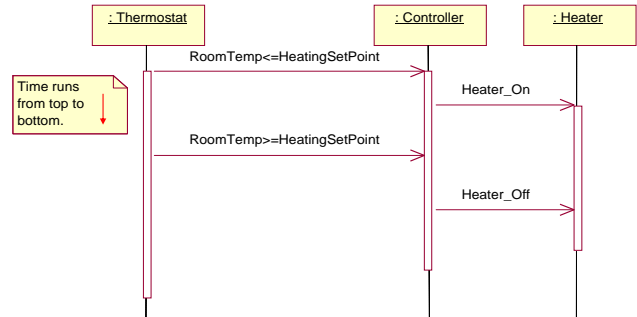
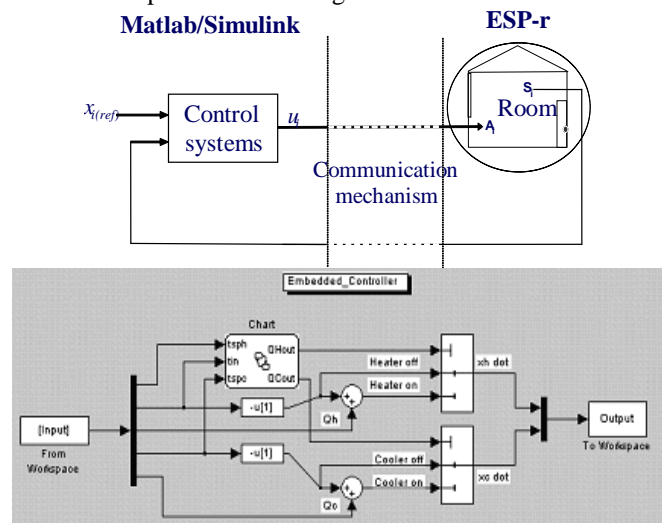

Figure 8. Sequence diagram for building heating mode.

As shown 8, control system switches on the heating plant of the test-cell when the room air-temperature is below the heating set-point, and switches it off when the indoor air-temperature is above the heating set-points. Such functioning of the controller (or control systems) can be formed into a state machine diagram such as Statecharts. Indeed, StateCharts developed by Harel (1987) are used as a visual modelling formalism for the specification and modelling of complex systems. Nevertheless, the modelling of most building performance operations remains complex. Therefore, StateCharts are used to model the functioning of heating process in buildings, especially in the test-cell. The Stateflow of Matlab/Simulink is thus used to simulate the StateChart model. The simulation results were obtained by run-time coupling between ESP-r and Matlab, which is in turn, coupled with Simulink and then with Stateflow. The figure 9 illustrates a simple graphical environment of how an embedded control system modelled on Matlab/Simulink is run-time coupled to its building model built on ESP-r.



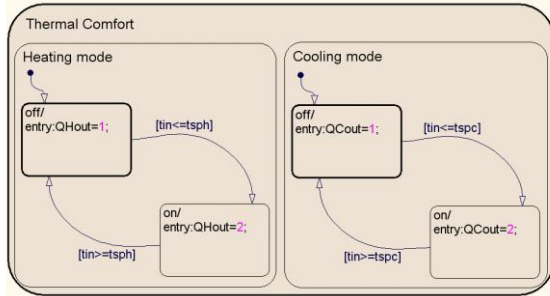

Figure 9. An Embedded control system for a building zone and plant model.

The main objective of this control system is to regulate the heating and cooling processes in the test-cell in order to maintain the variable of inside air-temperature as comfortable as possible. This controlled variable (or air-temperature) is regulated according to the reference (or desired) set point fixed by an occupant through a manual device input. When the room is occupied, the control system is active in order to maintain the indoor air-temperature around the desired air-temperature. In contrast when the room is vacant, the control system, and the indoor air-temperature is affected by the environment. In particular, the control system can also be enhanced to maintain the indoor air-temperature within a certain living conditions in order to be able to raise the indoor air-temperature to the set-point within a short defined time (e.g. 30mn) before an occupant is anticipated into the room. The common living conditions can be updated each time the variations of air-temperature appear important in the building.

A. Experimental and simulation results

With model-based distributed control and building performance simulation environments, the control algorithms can be designed and performed remotely of their building models while running the simulation either on the same computer or on two different computers connected by network. In this fact, it should be noted that the control systems (or controllers) implemented for experiments in Test cell are the same carried out for simulations. Therefore, the experimental and simulated results are obtained by the same control system in modelled on Matlab/Simulink for the same occupied period of time (from 6:30 to 18 o'clock). The test cell model shown in the figure 7 is actually modelled on ESP-r with the same material proprieties and the same construction dimensions as well as characteristics, and using the same climate data that were saved when performing experiments. Although the simulated results are obtained with a distributed mechanism between ESP-r and Matlab using run-time coupling as described above, Matlab/Simulink is synchronously launched by ESP-r at every ESP-r time step as a separate process. Figure 10 and 11 show the experimental and simulation results for this case study.

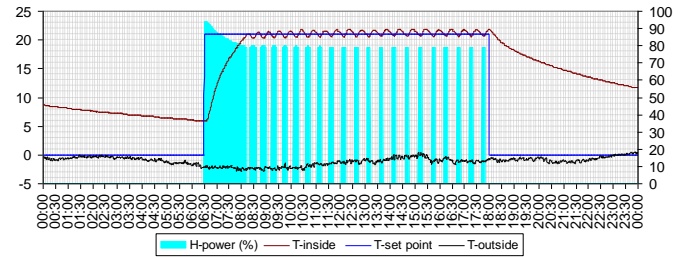

Figure 10. Experimental results.

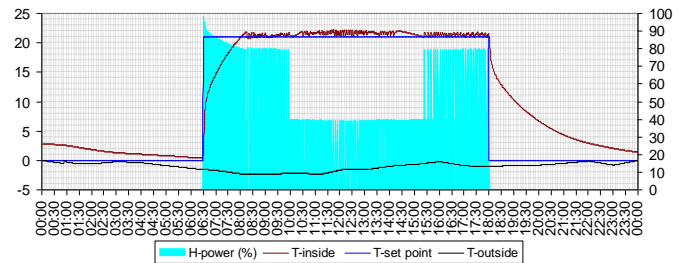

Figure 11. Simulation results.

A detailed comparison between experimental and simulation results shows that there are small changes in the control system responses due to the climate data that highly influence the air-temperature of the test cell. In winter, the outside temperature influences the indoor air-temperature over time and the control system is not designed to suppress sensitive input noise causing small chattering at short intervals of few seconds. However, this control system can be enhanced to filter such noises by an estimator to simultaneously cancel such chattering changes. In addition, hybrid systems can be easily coupled with any model-based modern control methods to eliminate any change that disturbs the indoor variable (see e.g. Sazonov, 2003). Another point to highlight is that the heating plant used in the test-cell is not dimmable. Even though the designed control systems is position, the heating plant in the test-cell can only be switched on or off completely. For this reason, there is a difference between experimental and simulation results as the control system responses obtained by simulation are dimmable as opposed to those obtained by experiments, in which they are not. In addition, ESP-r considers the climate data on an hourly basis, not in minutes as in experiments, in which the theoretical approximations in mathematical programming are used irregularly to represent closely practical issues. Nevertheless, these results show the importance of a distributed dynamic mechanism between ESP-r and Matlab/Simulink to enable the integration of advanced control applications in building performance simulation by run-time coupling.

B. Verification and Validation of a Distributed Simulation Mechanism

The concept of operations that run-time coupling between ESP-r and Matlab/Simulink must fulfill is determined during the specification phases. Due to the complexity of distributed systems, complete verification or complete validation is, in most cases, not possible (see e.g.

Girault and Valk, 2003). One of the most valuable design aspects of distributed systems is the availability of executable models to perform V&V activities throughout the V-lifecycle process, especially during its early design phases. For example, when NASA (2004) conducted a study of V&V activities, it found that a large number of errors discovered in the testing phase, a relatively late phase of the V-lifecycle, had been introduced at the beginning of the process as requirements errors. One way to address this issue is to integrate V&V issues in the execution model proposed by the INCOSE requirement engineering working group. The model is defined as follows:

- A resulting hierarchy of requirements composed of collections of requirements that correspond to the various parts of a distributed dynamic simulation mechanism.
- Wherever a derived requirement exists some analysis was involved. Such analysis makes use of accumulated knowledge, that run-time coupling between ESP-r and Matlab/Simulink may share to each other.
- Any particular requirement in a requirement collection in the hierarchy comes either from another collection, from an analysis, or an external source variously called concept of operations.
- As requirements are generated or revised the flow of requirements to collections must be done in an orderly, gated manner. The development and implementation of run-time coupling between ESP-r and Matlab/Simulink was established in such a way to fulfill all the requirements involved. Some requirements in collections do not pass to other collections or analyses but instead are implemented. That is, for example, a part is built or tested, or assembled from lower level components of a distributed dynamic simulation mechanism.
- In addition to requirements themselves, SE concept deals with a hierarchy of feasibilities, possibilities, and queries that are associated with the requirements. If the requirements are considered to flow “downward” then these items flow “upward”. As result, run-time between ESP-r and Matlab/Simulink is implemented using system-level considerations.

Finally, the requirement management process and tool must maintain control data for the requirement hierarchy and facilitate the use and operation of a distributed dynamic mechanism between ESP-r and Matlab/Simulink to enable the integration of advanced control applications in building performance simulation by run-time coupling. Figure 12 shows a study resulting from the foregoing analysis of V&V issues of a distributed simulation mechanism.

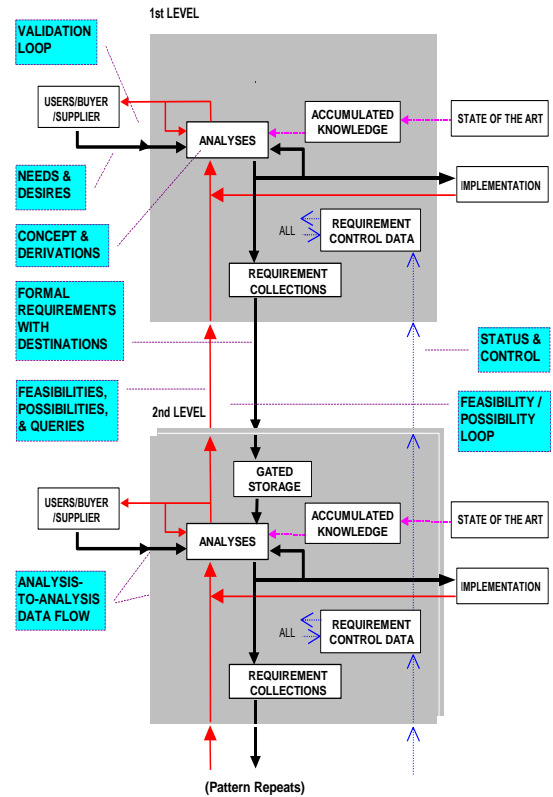

Figure 12. Foregoing analysis of V&V issues of a distributed simulation mechanism.

VI. CONCLUSION AND PERSPECTIVES

A system-level architectural design of embedded control systems for building performance application is presented and tested using a distributed dynamic simulation between CME and BPS by run-time coupling. One of the main objectives of this study attempted to apply SE concept to integrate advanced control systems in building environmental performance. This has been demonstrated by a procedural design approach to the development of embedded control systems for a building model. Hence, the importance of using a distributed dynamic mechanism between ESP-r and Matlab/Simulink to enable the integration of control applications in building performance simulation by run-time coupling over TCP/IP has qualified that any control system can now be implemented and deployed for any integrated building model. Such innovative approach to integrating control systems in building performance simulation provides a number of advantages over the traditional design approach. Within this approach, it is now possible to make buildings better for users by improving control systems in it using simulations as practical solutions.

However, hybrid systems can generalize real time systems by considering additional physical continuous properties of a building model and its environment. Although hybrid control systems arise on the use of multi-agent systems for intelligent control in buildings, this may rely on

dynamic autonomy control systems necessary to be introduced in building domain (Yahiaoui et al. 2006b). In addition to this, it is significant to consider that multi-agents based on hybrid systems are suitable to design intelligent control systems for complex building models. Therefore, practical solutions for automated building applications are provided by applying SE concept while developing and implementing a distributed dynamic simulation between control modelling and building performance simulation environments using run-time coupling. Such solutions require to be tailored to the specific issues concerning a design process reflecting both the building model and its control system. This is important issue concerning some perspectives in the building domain; there may be benefit in making a common document of specification requirements based on a trade-off between cost, schedule and requirements in order to realize a successful building performance application with at least both significant aspects: lower cost and customer satisfaction. In addition, a document of specification requirements would be the principal source of building design process used for developing, updating, and completing all building operations and sub-operations specifications, interface control requirements, specification trees, and test requirements that concern the building performance application.

REFERENCES

- Blanchard, B. S., "System Engineering Management", John Wiley & Sons, Inc., 1991.
- Booch, G., "Object-Oriented Design with Applications", Benjamin Cummings Redwood City CA, edition 1991.
- EERE, "Energy Efficiency and Renewable Energy" EERE's homepage, 2006 http://www.eere.energy.gov/buildings/building_america/se_research.html
- EIA-632, "Processes for Engineering a System (ANSI/EIA-632)", Proof Copy by Electronic Industries, edition 1998.
- DSMC, "Systems Engineering Management Guide", Proof Copy by Defense Systems Management College, Fort Belvoir, VA, edition 1990.
- Girault, C. and Valk. R., "Petri Nets for Systems Engineering", Springer, Tokyo, 2003.
- Harel, D., "Statecharts: A Visual Formalism for Complex Systems", *Journal of Science of Computer Programming*, Vol. 8, pp. 231-274, 1987
- Hatley, D. J. and Pirbhai, I. A., "Strategies for Real-Time System Specification", *Technical Proceedings of Dorset House*, New York, 1988
- NASA, "Return on Investment for Independent Verification & Validation", 2B Final Report, NASA, 2004.
- Hoang, N., Jenkins, M., Karangelen, N., "Data Integration for Military Systems Engineering." *Proceedings of IEEE Symposium & Workshop on Engineering of Computer Based Systems*, USA, 1996
- INCOSE, "International Council on Systems Engineering". INCOSE's website, 2010 <http://www.incose.org/>
- Mathers, G. and Simpson, K. J., "Framework for the Application of Systems Engineering in the Commercial Aircraft Domain", Report Version 1.2a, American Institute for Aeronautics and Astronautics, USA, 2000
- Shishko, R., "NASA Systems Engineering Handbook", Proof Copy by National Aeronautics and Space Administration, USA, edition 1995.
- Sheard, S. A. and Lake, J. G., "Systems Engineering Standards and Models Compared", *Proceedings of 8th Symposium of INCOSE*, Vancouver, Columbia, 1998.
- Sazonov, E. S., Klinkhachorn, P. and Klein, R. L., "Hybrid LQG-Neural Controller for Inverted Pendulum System", *Proceedings of 35th SSSST Symposium*, Morgantown, 2003.
- M.Messadia, A.E.K.Sahraoui: PLM as linkage process in a systems engineering framework
International Journal of Product Development, Vol.4, N°3/4, pp.382-395, 2007
- A.E.K.Sahraoui, D.M.Buede, A.P.Sage: Systems engineering research Journal of Systems Science and Systems Engineering, Vol.17, N°3, pp.319-333, Septembre 2008
- A.E.K.Sahraoui: The rationale paradigm in system development lifecycle. accepted for Int'l Journal of software and systems engineering
- Yahiaoui, A., Hensen J.L.M. and Soethout L.L., "Integration of control and building performance simulation software by run-time coupling", *Proceedings of IBPSA Conference and Exhibition 2003*, Vol. 3, pp. 1435-1441, Netherlands, 2003
- Yahiaoui, A., Hensen, J., and Soethout, L., "Developing CORBA-based distributed control and building performance environments by run-time coupling", *Proceedings of 10th ICCCB*, Weimar, Germany, 2004.
- Yahiaoui, A., Hensen J.L.M., Soethout L.L. and Van Paassen, D., "Interfacing of control and building performance simulation software with sockets", *Proceedings of IBPSA Conference and Exhibition 2005*, Montreal, 2005
- Yahiaoui, A., Sahraoui, A. E. K., Hensen, J. & Brouwer, P., "A Systems Engineering Environment for Integrated Building Design", UK Chapter of INCOSE proceedings, "European Systems Engineering Conference, Edinburgh, Scotland, 2006
- Yahiaoui, A., Hensen, J., Soethout, L., & Paassen, D., "Simulation based design environment for multi-agent systems in buildings", *Proceedings of 7th International Conference on System Simulation in Buildings*, Belgium, 2006
- Yahiaoui, A., "A Systems Engineering Approach to Embedded Control System Implementation in Buildings", *Proceedings of 18th annual International Symposium of INCOSE*, Netherlands, 2008.