



HAL
open science

Wide band RF MEMS VCO operating at 10 GHz

Nizar Habbachi, Hatem Boussetta, Mohamed Adel Kallala, Ali Boukabache,
Patrick Pons, Kamel Besbes

► **To cite this version:**

Nizar Habbachi, Hatem Boussetta, Mohamed Adel Kallala, Ali Boukabache, Patrick Pons, et al..
Wide band RF MEMS VCO operating at 10 GHz. International Conference on Circuits, Systems,
Control and Signals (CSCS), Jun 2017, Brasov, Romania. 5p. hal-01710150

HAL Id: hal-01710150

<https://laas.hal.science/hal-01710150>

Submitted on 15 Feb 2018

HAL is a multi-disciplinary open access archive for the deposit and dissemination of scientific research documents, whether they are published or not. The documents may come from teaching and research institutions in France or abroad, or from public or private research centers.

L'archive ouverte pluridisciplinaire **HAL**, est destinée au dépôt et à la diffusion de documents scientifiques de niveau recherche, publiés ou non, émanant des établissements d'enseignement et de recherche français ou étrangers, des laboratoires publics ou privés.

Wide band RF MEMS VCO operating at 10 GHz

Nizar Habbachi

Microelectronics and Instrumentation Laboratory, Faculty of Sciences of Monastir, University of Monastir, 5000 Monastir, Tunisia,
habbachinizar@yahoo.fr

Hatem Boussetta

Institut Préparatoire aux Etudes d'Ingénieurs de Monastir, Rue Ibn Eljazzar - 5019 Monastir Tunisia, and he is with Microelectronics and Instrumentation Laboratory, Faculty of Sciences of Monastir, University of Monastir, 5000 Monastir, Tunisia,
hatem_boussetta@yahoo.fr

Mohamed Adel Kallala

Military Research Centre, Tunis, and he is with Microelectronics and Instrumentation Laboratory, Faculty of Sciences of Monastir, University of Monastir, 5000 Monastir, Tunisia,
Adel.kallala@gmail.com

Ali Boukabache

Laboratory for Analysis and Architecture of Systems, CNRS, LAAS, 7 avenue du Colonel Roche, 31077 Toulouse, France, and he is with the University of Toulouse, 1077 Toulouse, France,
aboukaba@laas.fr

Patrick Pons

Laboratory for Analysis and Architecture of Systems, CNRS, LAAS, 7 avenue du Colonel Roche, 31077 Toulouse, France,
ppons@laas.fr

Kamel Besbes

Center for Research on Microelectronics & Nanotechnology, CRMN Sousse TechnoPark, BP 334 Sahloul Sousse, Tunisia, and he is with Microelectronics and Instrumentation Laboratory, Faculty of Sciences of Monastir, University of Monastir, 5000 Monastir, Tunisia,
kamel.besbes@fsm.rnu.tn

Abstract— this paper presents a wide band RF MEMS VCO operating at 10 GHz. The designed VCO is based on high performances RF MEMS solenoid inductor. We have used HFSS software for design and analysis of different RF MEMS solenoid inductors. Best performances are obtained using SU8 dielectric substrate and copper coil: $Q_{\max}=60.9$, $L=2.6$ nH at 10 GHz, and $SRF=20.8$ GHz. Moreover, we have investigated the time domain and the frequency responses of our RF MEMS VCO. The obtained results show symmetrical sinusoid signals with high voltage outputs upper than 1.2 V and a low phase-noise $PN=-102.37$ dBc/Hz at 1 MHz. In addition, the frequency band is comprised between 10.09 GHz and 14.6 GHz leading to a wide tuning range of $TR=44.69\%$.

Keywords-MEMS; VCO; solenoid inductor; wide band; high spectral;

I. INTRODUCTION

Technological progress provides a fundamental basis for RF applications evolution and remains the essential brick of all its advances. Furthermore, MEMS technics are increasingly used in RF synthesizer for higher performances resonators embedded in oscillators' architecture.

The first oscillators use quartz resonator in order to generate a high spectral signal. The operation frequency of quartz oscillators ranges from a few kHz to tens of MHz. There are several oscillator using quartz in their architecture: Pierce oscillator [1], Overtone oscillator [2], Miller oscillator [3], and Colpitts oscillator [4]. Their operating frequency is limited by the resonant frequency of quartz and they could be integrated in PLL architecture leading to compensate the phase noise error.

In this paper, we are interested by wide band VCO operating at 10 GHz using RF MEMS solenoid inductor. In the first paragraph, we have explored the effect of different materials on RF MEMS solenoid inductor. We have used two types of substrate: dielectric resin SU8 and conventional silicon. We have analyzed the performances at each case using two different metal core: gold and copper. In the second paragraph, we have integrated the most performant inductor in the VCO architecture. Moreover, we have analyzed the time domain outputs for the two extremities control voltages and we have presented the frequency responses of our VCO.

II. PERFORMANCES ANALYZES OF RF MEMS SOLENOID INDUCTORS:

In this part, we expose the results of four solenoids inductors having the same geometrical dimensions and different materials for the substrate and the core metal. The objective is to study the RF responses of these inductors for high frequency range comprised between 100 MHz and 100 GHz, and we integrate the best performances' inductor in a 10 GHz VCO architecture.

The Fig. 1 presents the 3D perspective of 5 turns RF MEMS solenoid inductor with the appropriate dimensions on top and front view:

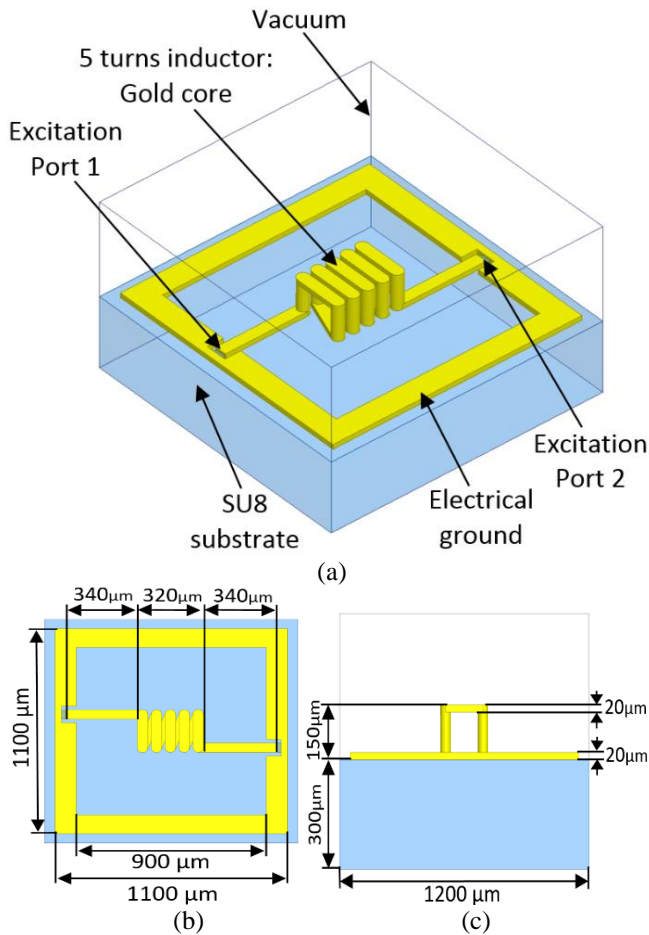

Fig. 1 RF MEMS solenoid inductor (a) 3D perspective (b) top view (c) front view with detailed dimensions.

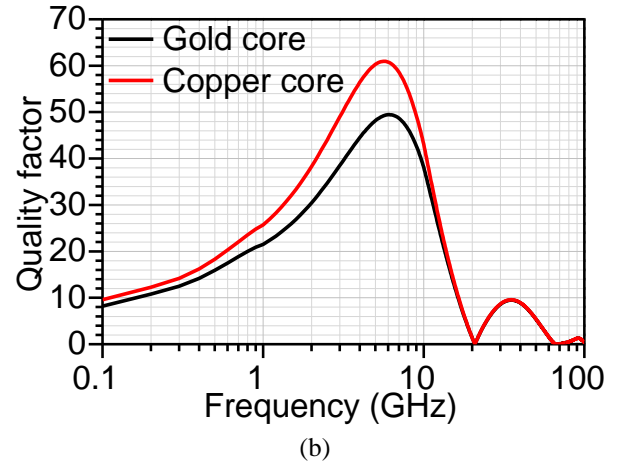
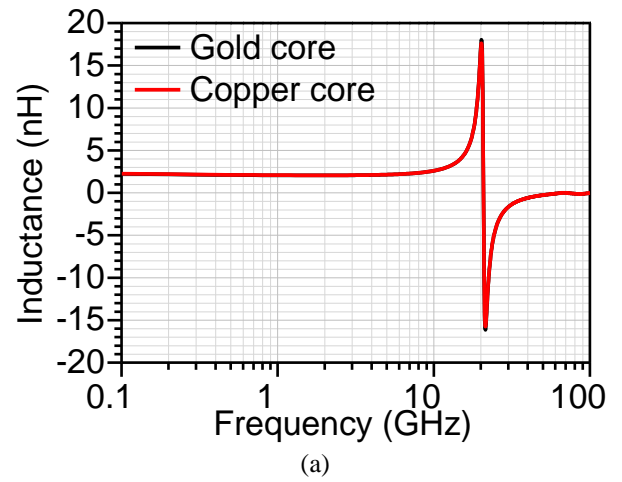

Fig. 2 Inductor performances in response of frequency variation (a) inductance value (b) quality factor.

A. Dielectric SU8 substrate:

The two first inductors use a dielectric substrate "SU8 resin" and they are formed by two different metallic core: gold and copper. The SU8 resin is a low loss dielectric resin $\tan\delta = 0.04$ presenting a very low permittivity $\epsilon = 2.9$, and it is appropriate for high frequency domain [5-8]. Moreover, the employed metals having high electric conductivity such: $\sigma = 41.10^6$ S/m for gold and $\sigma = 57.10^6$ S/m for copper.

The performances of different RF MEMS solenoid inductors are determined by equations below:

$$L(f) = \frac{\text{Im}(1/Y_{11})}{2 \cdot \pi \cdot f} \quad (1)$$

$$Q(f) = \frac{\text{Im}(Y_{11})}{\text{Re}(Y_{11})} \quad (2)$$

The inductance value versus frequency is presented in Fig. 2a. As we can see, in two cases the inductance curves are almost identical. The inductance value is stable for a large frequency range and it is close to $L = 2.6$ nH until 10 GHz and the resonant frequency is higher than 20.8 GHz.

The Fig. 2b illustrates the quality factor variation in response of frequency. It is clearly seen that copper core quality factor is higher than gold core. Indeed, the quality factor is limited by the serial resistance of the inductor core and when the coil conductivity rises the resistance weakens. The maximum value of the quality factor occurs at 5.7 GHz and we obtain $Q_{\max} = 60.9$ for copper coil and $Q_{\max} = 49.4$ for gold coil.

B. Conventional silicon substrate:

The third and fourth inductors are superposed on a conventional silicon substrate having a low conductivity $\sigma = 3$ S/m and possess a high relative permittivity $\epsilon = 11.2$. We have also used two different metal for the inductor core: gold and copper. The inductors performances results in response of frequency are joined in Fig. 3:

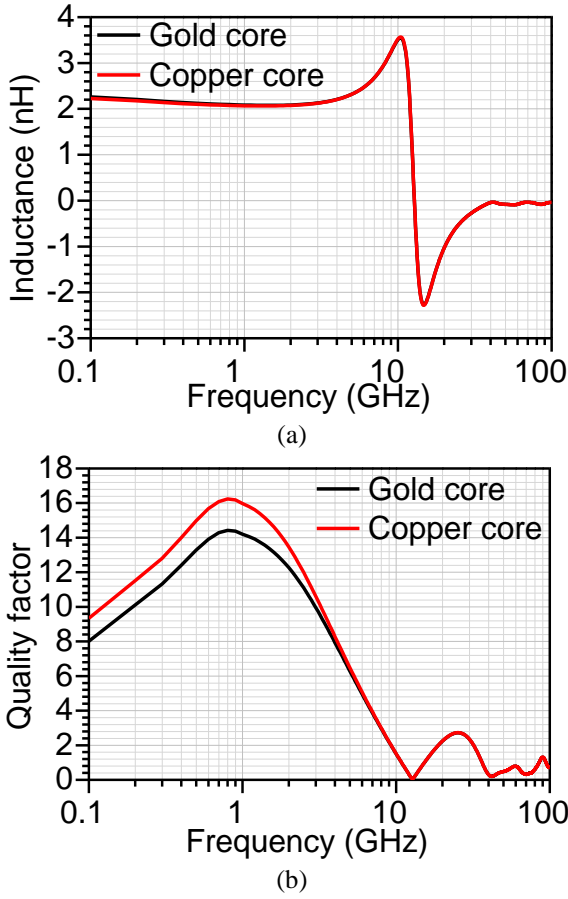

Fig. 3 Inductor performances in response of frequency variation (a) inductance value (b) quality factor.

The Fig. 3a shows a good similarity of inductance curves in response of frequency in two cases: gold core and copper core. In addition, the resonant frequency is upper than 12 GHz and but it is lower than the two first cases using SU8 substrate. Once more, the Fig. 3b shows that the quality factor of copper coil $Q_{\max}=16.2$ is higher than $Q_{\max}=14.4$ of gold coil. The Table 1 resume the different results of four designed RF MEMS solenoid inductors:

TABLE I. PERFORMANCES RESULTS OF DIFFERENT RF MEMS SOLENOID INDUCTORS

Substrate	Core metal	Maximum quality factor	Inductance value at 10 GHz	Resonant frequency
Dielectric: SU8	Gold	49.4 at 6.1 GHz	2.6 nH	20.8 GHz
	Copper	60.9 at 5.7 GHz		
Conventional: Silicon	Gold	14.4 at 0.8 GHz	3.5 nH	12.8 GHz
	Copper	16.2 at 0.8 GHz		

These results demonstrate the importance of the SU8 substrate and the copper metal in the design of high performances RF MEMS solenoid inductors.

III. DESIGN AND SIMULATION OF 10 GHz RF MEMS VCO:

A. VCO architecture:

The design and the simulation of the VCO is realized using ADS software and TSMC RF CMOS 0.13 μm standard technology. We have used the second solenoid inductor based on copper core and SU8 substrate in order to design the 10 GHz VCO. The Fig. 4 presents the architecture of complementary cross-coupled VCO and the dimensions of PMOS and NMOS transistors:

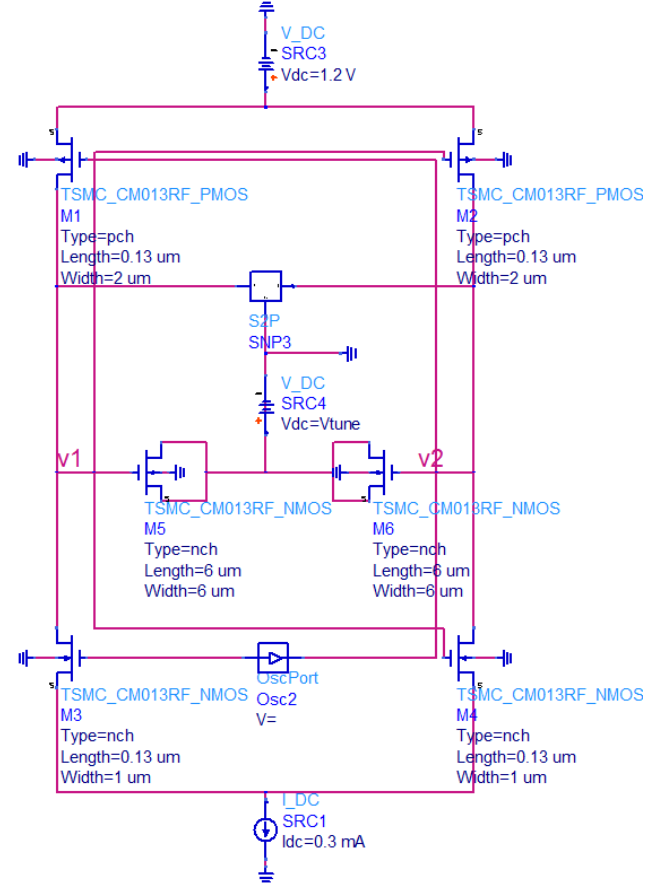
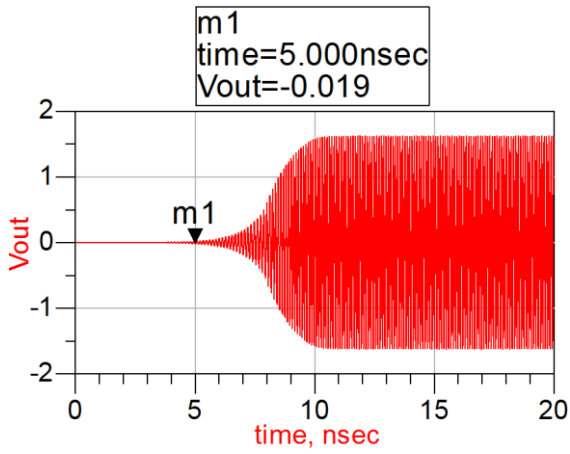

Fig. 4 Cross-coupled CMOS VCO using RF MEMS solenoid inductor.

B. Time domain analyzes:

The time domain response of the designed VCO is investigated for two-extremity voltages controls $V_{ctrl} = 0\text{V}$ and $V_{ctrl} = 0.5\text{V}$. Indeed, the rise of V_{ctrl} value lead to the expansion of oscillation frequency and influences the time domain response of the VCOs. It is important to evaluate the reaction of VCOs at two V_{ctrl} limits in order to analyze the output voltage signals behavior at two frequencies extremity. The Fig. 5 illustrates two output signals behaviors in response of time from 0 s to 20 ns:



(a)

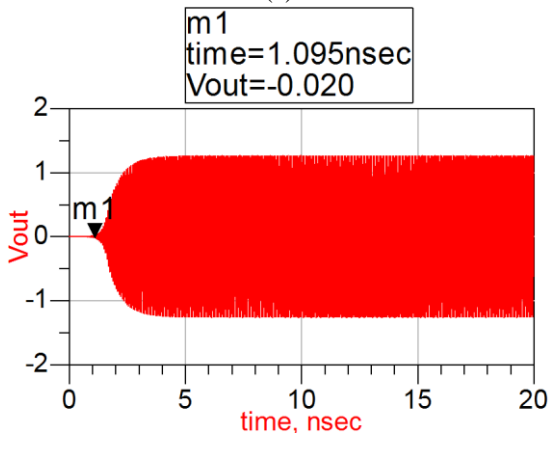

(b)

Fig. 5 Time domain VCO performances at: (a) $V_{ctrl}=0V$ (b) $V_{ctrl}=0.5V$.

The Fig. 5a presents the response of the VCO for the initial control voltage $V_{ctrl}=0V$. As we can see, the start-up time reaches 5 ns and the steady state time is 11 ns. In Fig. 5b, when the control voltage increases $V_{ctrl}=0.5V$ the start-up time and the steady state time decrease and reaches respectively: 1 ns and 5 ns. These results demonstrate the amelioration of the speed response of our VCO in responses of V_{ctrl} .

Moreover, we have zoomed the output signals as shown in Fig. 6:

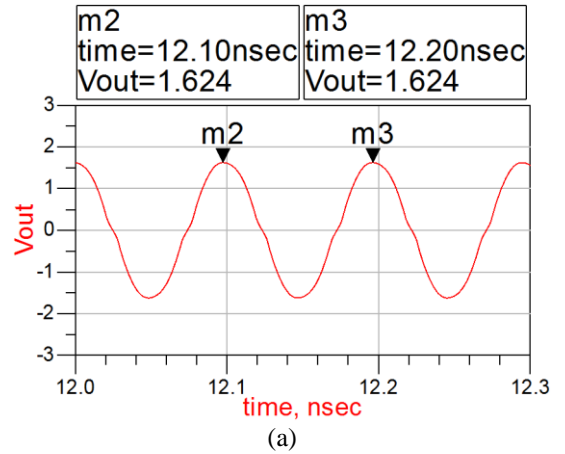

(a)

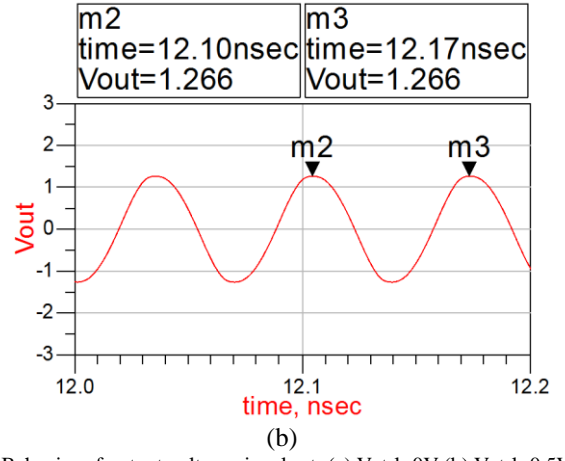

(b)

Fig. 6 Behavior of output voltage signals at: (a) $V_{ctrl}=0V$ (b) $V_{ctrl}=0.5V$.

The Fig. 6a show symmetrical sinusoidal oscillations with a period of 0.1 ns and a peak voltage of 1.62 V at $V_{ctrl}=0V$. At the last $V_{ctrl}=0.5V$ (Fig. 6b), the period reaches 0.07 ns and the output peak voltage remains greater than 1.2V (the supply voltage of the VCO). These results reveal a wide variation of oscillation frequency with high voltage sinusoidal output signals.

C. Frequency response analyzes:

The phase noise presents a critical parameter for RF designer and they need to decrease its value as much as possible for high spectral frequency synthesizer. Consequently, we have extracted the phase noise value and the output spectrum at 10 GHz. Moreover, we have investigated the frequency responses of our VCO as illustrated in Fig. 7:

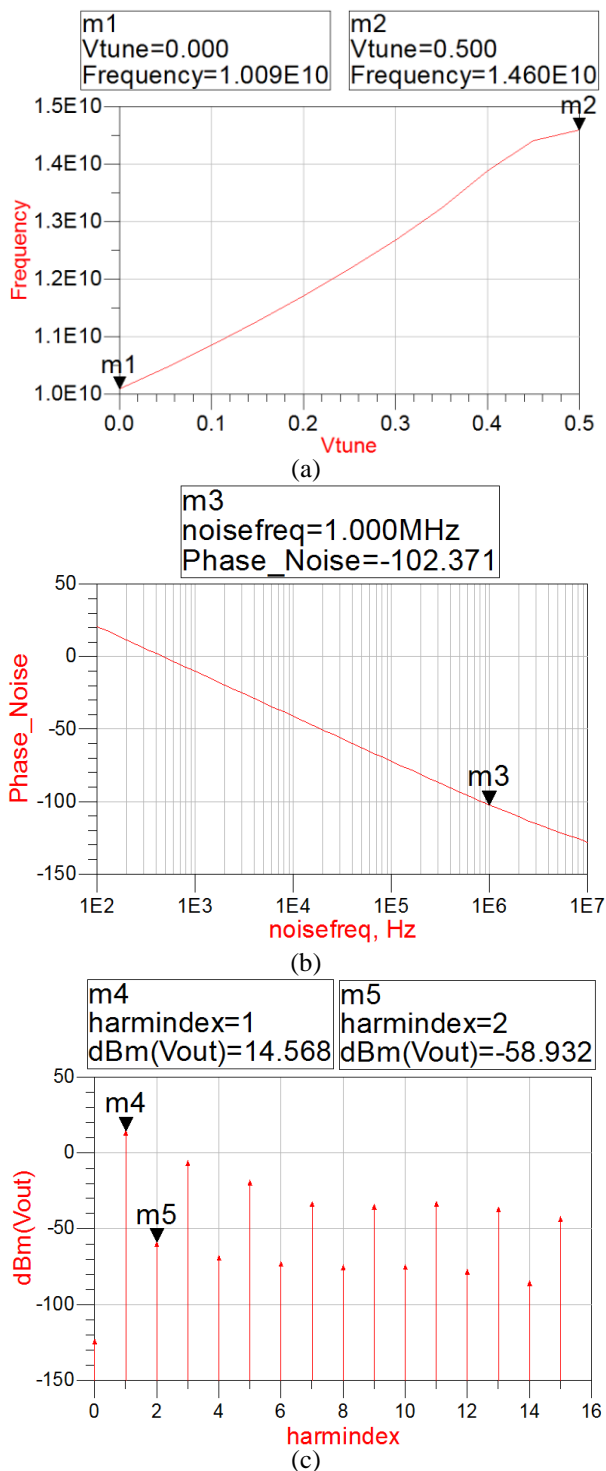

Fig. 7 Frequency analyzes (a) tuning range (b) phase noise response (c) spectral output voltage harmonics.

The Fig. 7a shows a good linearity of the frequency variation in response of control voltage. In addition, the frequency band is comprised between 10.09 GHz and 14.6 GHz leading to a wide tuning range of TR=44.69%. Moreover, as we can see in Fig. 7b, the phase noise is about -102.37dBc/Hz at 1 MHz of offset frequency. This result proves that our VCO could be efficient for low phase-noise wireless system. Moreover, the

peak output power of our VCO reaches 14.56dBm at a center frequency of 10 GHz and the peak of the second harmonic is less than -58.9dBm (Fig. 7(c)). This result shows high spectral signal ability at 10 GHz.

IV. CONCLUSION:

Different RF MEMS solenoid inductors are designed using two substrates and two metals cores. The best performances' solenoid inductor are achieved with a dielectric SU8 substrate and a copper coil. The obtained results show a high quality factor that reaches $Q_{max} = 60.9$, a wide resonant frequency band upper than 20 GHz, and a stable inductor value $L = 2.6$ nH until 10 GHz. Furthermore, the selected RF MEMS solenoid inductor is integrated in VCO architecture for wireless communication systems operating at 10 GHz. The time domain and the frequency investigations of RF MEMS VCO show a high spectrum output signals and wide band tuning range upper than TR = 44%.

REFERENCES

- [1] Bahadur, H.; Parshad, R.; "Modified Pierce oscillator circuit"; Proceedings of the IEEE Volume: 66, Issue: 2 Publication Year: 1978.
- [2] Tsuzuki, Y.; Adachi, T.; Ji Wen Zhang; "Fast start-up crystal oscillator circuits"; IEEE International Frequency Control Symposium, 49th Proceedings of the 1995.
- [3] Rodriguez- Pardo, L.; Farina, J.; Gabrielli, C.; Perrot, H.; Brendel, R.;" Miller Oscillators for High Sensitivity Quartz Crystal Microbalance Sensors in Damping Media", IEEE International Frequency Control Symposium and Exposition, 2004.
- [4] Xiaojuan Ou; Wei Zhou; Hongbo Kang; "Phase-noise Analysis for single and Dual-mode Colpitts Crystal Oscillators"; IEEE international frequency control symposium and exposition, 2006.
- [5] Pinon, S., Diedhiou, D. L., Gué, A. M., Fabre, N., Prigent, G., Conédéra, V., ... & Boukabache, A. (2012). "Development of a microsystem based on a microfluidic network to tune and reconfigure RF circuits". *Journal of Micromechanics and Microengineering*, 22(7), 074005.
- [6] El Gmati, I., Calmon, P. F., Boukabache, A., Pons, P., Fulcrand, R., Pinon, S., ... & Besbes, K. (2011). "Fabrication and evaluation of an on-chip liquid micro-variable inductor". *Journal of micromechanics and microengineering*, 21(2), 025018.
- [7] Habbachi, N., Boussetta, H., Boukabache, A., Kallala, M. A., Pons, P., & Besbes, K. (2016). "Tunable MEMS capacitor: influence of fluids". *Electronics Letters*.
- [8] Habbachi, N., Boussetta, H., Boukabache, A., Kallala, M. A., Pons, P., & Besbes, K. (2016). "Fabrication and modeling of a capacitor microfluidically tuned by water". *IEEE Electron Device Letters*.