



HAL
open science

Alarm management based on diagnosis

John William Vásquez, Louise Travé-Massuyès, Audine Subias, Fernando Jimenez, Carlos Agudelo

► **To cite this version:**

John William Vásquez, Louise Travé-Massuyès, Audine Subias, Fernando Jimenez, Carlos Agudelo. Alarm management based on diagnosis. 4th IFAC International Conference on Intelligent Control and Automation Sciences (ICONS16), Jun 2016, Reims, France. 6p. hal-01847436

HAL Id: hal-01847436

<https://laas.hal.science/hal-01847436>

Submitted on 23 Jul 2018

HAL is a multi-disciplinary open access archive for the deposit and dissemination of scientific research documents, whether they are published or not. The documents may come from teaching and research institutions in France or abroad, or from public or private research centers.

L'archive ouverte pluridisciplinaire **HAL**, est destinée au dépôt et à la diffusion de documents scientifiques de niveau recherche, publiés ou non, émanant des établissements d'enseignement et de recherche français ou étrangers, des laboratoires publics ou privés.

Alarm management based on diagnosis

J.W. Vásquez* L. Travé-Massuyès** A. Subias***
F. Jimenez**** C. Agudelo†

* CNRS, LAAS, 7 avenue du colonel Roche, F-31400 Toulouse, France
(e-mail: jwvasque@laas.fr).

** Univ de Toulouse, LAAS, F-31400 Toulouse, France (e-mail:
louise@laas.fr)

*** Univ de Toulouse, INSA, LAAS, F-31400 Toulouse, France
(e-mail: subias@laas.fr)

**** Universidad de los Andes, Bogotá, Colombia (e-mail:
fjimenez@uniandes.edu.co)

† Instituto Colombiano del Petróleo ICP, Piedecuesta, Colombia
(e-mail: carlos.agudelo@ecopetrol.com.co)

Abstract: The transitions between operational modes (startup/shutdown) in chemical processes generate alarm floods and cause critical alarm saturation. We propose in this paper an approach of alarm management based on a diagnosis process. This diagnosis step relies on situation recognition to provide to the operators relevant information on the failures inducing the alarms flows. The situation recognition is based on chronicle recognition where we propose to use the hybrid causal model of the system and the expertise to generate the pattern event sequences from which the chronicles will be extracted using the Heuristic Chronicle Discovery Algorithm Modified *HCDAM*. An illustrative example in the field of petrochemical plants is presented in the article.

Keywords: Alarm management, Diagnosis, Chronicles, Transitional stages, Hybrid models

1. INTRODUCTION

The petrochemical industries losses have been estimated at 20 billion dollars only in the U.S. each year, and the AEM (Abnormal Events Management) has been classified as a problem that needs to be solved. Hence the alarm management is one of the aspects of great interest in the safety planning for the different plants. In the process state transitions such as startup and shutdown stages, the alarm flood increases and generates critical conditions in which the operator does not respond efficiently. A dynamic alarm management is then required (Beebe et al. (2013)). Currently, many fault detection and diagnosis techniques for multimode processes have been proposed; however, these techniques cannot indicate fundamental faults in the basic alarm system, Zhu et al. (2014); in the other hand the technical report Advance Alarm System Requirements EPRI (The Electric Power Research Institute) suggests a cause-consequence and event-based processing. Therefore, in this paper, a dynamic alarm management strategy is proposed in order to deal with alarm floods happening during transitions of chemical processes. This approach relies on situations recognition (i.e. chronicle recognition). As, the efficiency of alarm management approaches depends on the operator expertise and process knowledge, our final objective is to develop a diagnosis approach as a decision tool for operators. The paper is divided into 5 sections. Section 2 presents the Chronicle based alarm management proposal. The Section 3 presents the case study related with an illustrative application in the petrochemical sector. Section 4 expresses the formal framework

for this analysis including the hybrid causal model and the description of the chronicle discovery algorithm. Finally, the construction of the chronicle database is given in the section 5.

2. CHRONICLE BASED ALARM MANAGEMENT

The Chronicle Based Alarm Management (CBAM) methodology proposed in this paper merges different techniques to take the hybrid aspect and the standard operational procedures of the concerned processes into account. These two features stand out of the literature (Jing et al. (2013), S. Xu (2014), Srinivasan et al. (2005), Bhagwat et al. (2003)). Another important aspect is the analysis of the Dynamic Alarm Management: most of the time the alarm is assumed to be a static indicator, in our proposal an alarm is an event with an occurrence date and the alarm flow is formally modeled by a chronicle (Vasquez et al. (2015)) as presented in section 4.2. Transposing this methodology to large-scale systems would benefit from a decentralized approach in which local chronicles would be learned and then integrated thanks to shared events. The main steps of this methodology are:

- (1) From the standard operating procedures and from the evolution of the continuous variables, determine the set of event types in startup and shutdown stages.
- (2) From the expertise and the event abstractions determine the date of occurrence of each event type to construct the representative event sequences.

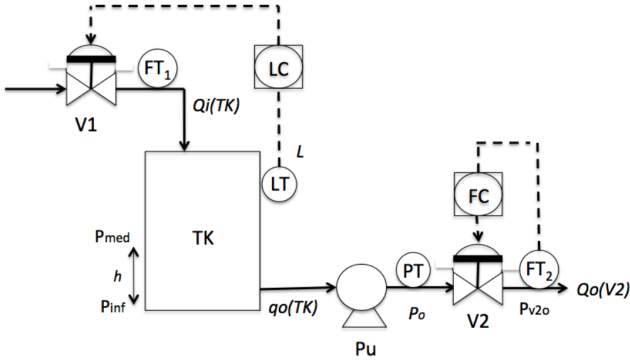

Fig. 1. Hydrostatic Tank Gauging

- (3) From the representative event sequences in each scenario, determine the chronicle database using the algorithm *HCDAM* (Heuristic Chronicle Discovery Algorithm Modified).

In a general way, the chronicle learning requires a lot of representative event sequences of each scenario. In our case no historical information related to startup or shutdown stages is available, as these types of scenarios do not occur frequently. Therefore, it is by simulation that the representative event sequences of each scenario are obtained. The different steps of the methodology will be detailed further in the article and the next section presents the case study.

3. CASE STUDY - HTG (HYDROSTATIC TANK GAUGING) SYSTEM

The Cartagena Refinery in Colombia as recently be enriched by news units and elements. Our proposal aims at helping the operator to recognize dangerous conditions during the startup stage of the refinery with modified equipments. To start our analyze, we focus on the startup and shutdown stages in the unit of water injection. This process is a HTG (Hydrostatic Tank Gauging) system composed of passive components, active components and sensors. The passive components are components which cannot change the operational state, e.g. the tank (*TK*). In the other hand, the active components can change their states of operation by a procedural action, e.g. the two normally closed valves (*V1* and *V2*) and the pump (*Pu*). The sensors, correspond to the instrumentation that measures the continuous variables, e.g. level sensor (*LT*), pressure sensor (*PT*), inflow sensor (*FT₁*) and outflow sensor (*FT₂*), see Fig. 1. The standard operating procedures give us the standard procedural actions for the startup and shutdown stages. For the correct execution of these procedures, the operators must execute the actions according to the correct evolution of the procedure. The abnormal situations are detected when the evolution of the procedural actions and the continuous variables evolution do not correspond to the standard operating procedure and wrong event type occurrences, happen. The fluctuations of the inlet flow of the tank, the response time of the pump that causes the outlet pressure and other conditions generate uncertain that can be determined by expertise. because to obtain a complex model which simulate all the

process uncertain requires a lot of time and resources to build it.

4. FORMAL FRAMEWORK

This section presents the formal framework of the Chronicle Based Alarm Management (CBAM) methodology proposed.

4.1 Hybrid Causal Model

The hybrid system is represented by an extended transition system, whose discrete states represent the different modes of operation for which the continuous dynamics are characterized by a qualitative domain. Formally, a hybrid causal system is defined as a tuple Pons et al. (2015):

$$\Gamma = (\vartheta, D, Tr, E, CSD, Init, COMP, DMC) \quad (1)$$

Where

- $\vartheta = \{v_i\}$ is a set of continuous *process variables* which are function of time t .
- D is a set of discrete variables. $D = Q \cup K \cup V_Q$.
 - Q is a set of states q_i of the transition system which represent the system operation modes.
 - The set of auxiliary discrete variables $K = \{K_i, i = 1, \dots, n_c\}$ represents the system configuration in each mode q_i , where K_i indicates the discrete state of the active components.
 - V_Q is a set of qualitative variables whose values are obtained from the behavior of each continuous variable v_i .
- $E = \Sigma \cup \Sigma^c$ is a finite set of observable (Σ_o) and unobservable (Σ_{uo}) event types, noted σ , where:
 - Σ is the set of event type associated to the procedural actions in the startup or shutdown stages.
 - Σ^c is the set of event type associated to the behavior of the continuous process variables.
- $Tr : Q \times \Sigma \rightarrow Q$ is the transition function. The transition from mode q_i to mode q_j with associated event σ is noted (q_i, σ, q_j) .
- $CSD \supseteq \bigcup_i CSD_i$ is the *Causal System Description* or the causal model used to represent the constraints underlying the continuous dynamics of the hybrid system.
 - Every CSD_i associated to a mode q_i , is given by a graph $(G_c = \vartheta \cup K, I)$. I is the set of influences where there is an edge $e(v_i, v_j) \in I$ from $v_i \in \vartheta$ to $v_j \in \vartheta$ if the variable v_i influences variable v_j . A dynamic continuous model DMC_{I_k} is associated to every influence $I_k \in I$, see Fig. 2. The model of the active component corresponds to a transfer function of first order with delay. The set of components is noted as *COMP*.
- *Init* is the initial condition of the hybrid system,

4.2 Chronicle model

Let us consider time as a linearly ordered discrete set of instants. The occurrence of different events in time represents the system dynamics and a model can be determined to diagnose the correct evolution. An event is defined as a pair (e_i, t_i) , where $e_i \in E$ is an event

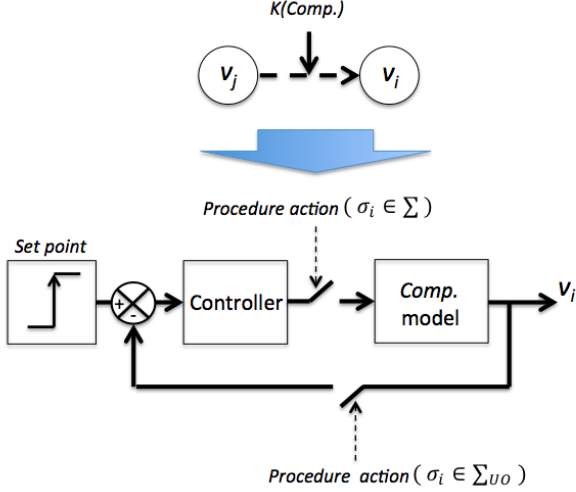

Fig. 2. Dynamic Model of Control *DMC*

type and t_i is a variable of integer type called the event date. We define E as the set of all event types and a temporal sequence on E is an ordered set of events denoted $S = \langle (e_i, t_i) \rangle_j$ with $j \in N_l$ where l is the size of the temporal sequence S and N_l is a finite set of linearly ordered time points of cardinal l . $l = |S|$ is the size of the temporal sequence, i.e. The number of event type occurrences in S .

Definition 1: A chronicle is defined as a triplet $C = (\xi, \mathcal{T}, \mathcal{G})$ such that:

- $\xi \subseteq E$. ξ is called the typology of the chronicle.
- \mathcal{T} is the set of temporal constraints of the chronicle.
- $\mathcal{G} = (\mathcal{V}, \mathcal{A})$ is a directed graph where:
 - \mathcal{V} represent the event types of ξ
 - The arcs \mathcal{A} represents the time constraints between *event dates*. (Subias et al. (2014))

If the event e_1 occurs t time units after e_2 , then it exists a directed link \mathcal{A} from e_1 to e_2 associated with a time constraint. Considering the two events (e_i, t_i) and (e_j, t_j) , we define the time interval as the pair $\tau_{ij} = [t^-, t^+]$, $\tau_{ij} \in \mathcal{T}$ corresponding to the lower and upper bounds on the temporal distance between the two event dates t_i and t_j .

The two next sections present what is an event in our approach and how are defined the events types : we consider two sets of events; those generated by a qualitative abstraction fo the process continuous behaviour and those identified form the knowledge of standard operating procedures.

4.3 Event generation by qualitative abstraction of continuous behavior

In each mode of operation, variables evolve according to the corresponding dynamics. This evolution is represented with qualitative values. The domain $D(V_i)$ of a qualitative variable $V_i \in V_Q$ is obtained through the function $f_{qual} : D(v_i) \rightarrow D(V_i)$ that maps the continuous values of variable v_i to ranges defined by limit values (High noted H_i and Low noted L_i).

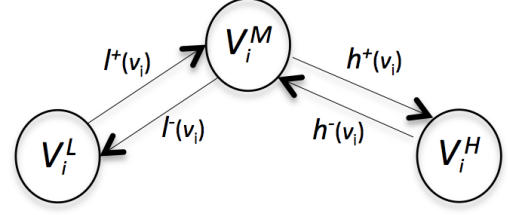

Fig. 3. Automaton G_{V_i}

$$f(v_i)_{qual} = \begin{cases} V_i^H & \text{if } v_i \geq H_i \\ V_i^M & \text{if } L_i < v_i < H_i \\ V_i^L & \text{if } v_i \leq L_i \end{cases} \quad (2)$$

The behavior of these qualitative variables is represented in Fig. 3 by the automaton $G_{V_i} = (V_Q, \Sigma^c, \gamma)$ where V_Q is the set of the possible qualitative states (V_i^L : Low, V_i^M : Medium, V_i^H : High) of the continuous variable v_i , Σ^c is the finite set of events associated to the transitions and $\gamma : V_Q \times \Sigma^c \rightarrow V_Q$ is the transition function. The corresponding event generator is defined by the abstraction function $f_{V_Q \rightarrow \sigma}$

$$f_{V_Q \rightarrow \sigma} : V_Q \times \gamma(V_Q, \Sigma^c) \rightarrow \Sigma^c$$

$$\forall V_i \in V_Q, (V_i^n, V_i^m) \rightarrow \begin{cases} l^+(v_i) & \text{if } V_i^L \rightarrow V_i^M \\ l^-(v_i) & \text{if } V_i^M \rightarrow V_i^L \\ h^+(v_i) & \text{if } V_i^M \rightarrow V_i^H \\ h^-(v_i) & \text{if } V_i^H \rightarrow V_i^M \end{cases}$$

$$V_i^n, V_i^m \in \{V_i^L, V_i^M, V_i^H\} \quad (3)$$

$$\Sigma^c = \bigcup_{v_i \in \mathcal{D}} \{l^+(v_i), l^-(v_i), h^+(v_i), h^-(v_i)\} \quad (4)$$

4.4 Event identification from procedural action

In the system *HTG* of the case of study, the set of event types Σ that represent the procedure actions is:

$$\Sigma = \{V1_{c,o}, V2_{c,o}, Pu_{f-n}, V1_{o,c}, V2_{o,c}, Pu_{n-f}, M/A\} \quad (5)$$

where $V1_{c,o}$ (resp. $V2_{c,o}$) is for the action that switches the valve $V1$ (resp. $V2$) from closed to opened. $V1_{o,c}$ ($V2_{o,c}$) for the action that switches the valve $V1$ (resp. $V2$) from to opened to closed and Pu_{f-n} (reap. Pu_{n-f}) for the action that turns on (reps. off) the pump. The event M/A corresponds to the transition from *manual* to *automatic* operation, closing the control loops. In the reminder we assume that this event is the only unobservable event of the system i.e. $M/A \in \Sigma_{uo}$.

The underlying DES (Discrete event system) of the *HTG* system represents the sequence of observable procedure actions for a startup stage (indicated by the red or green arrows on Fig. 4) corresponding to the evolution of the operation modes (i.e q_0, q_1, q_4, q_5 and q_7). To each operation mode q_i is associated a causal system description to identify the influences between the variables L, P_o and $Q_o(V2)$ see Fig. 5. These influences allow to determine the event types Σ^c occurrence.

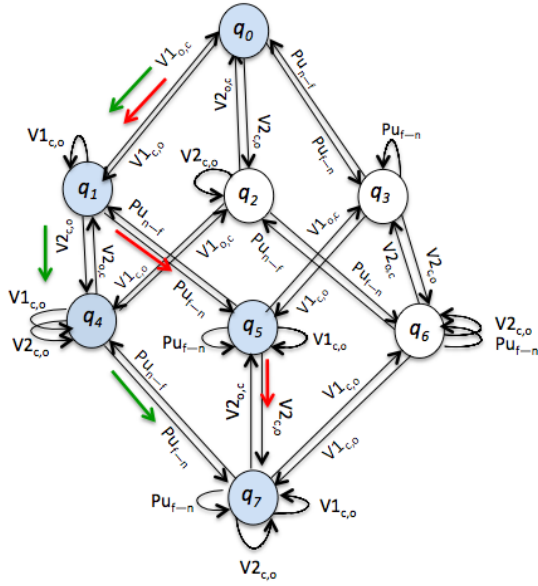

Fig. 4. Underlying DES of the HTG system

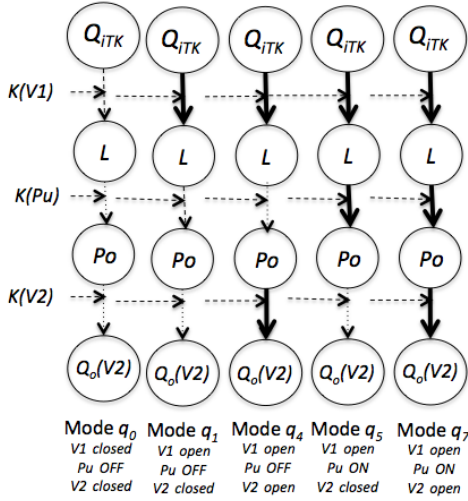

Fig. 5. CSD in the modes q_0, q_1, q_4, q_5, q_7

$$\Sigma^c = \begin{cases} l_{(L)}^+, l_{(L)}^-, h_{(L)}^+, h_{(L)}^-, \\ l_{(Po)}^+, l_{(Po)}^-, h_{(Po)}^+, h_{(Po)}^-, \\ l_{(Q_{oV2})}^+, l_{(Q_{oV2})}^-, h_{(Q_{oV2})}^+, h_{(Q_{oV2})}^- \end{cases} \quad (6)$$

4.5 Event sequence generation

The event sequences are generated according to the behavior of the system in each scenario. In the remainder, to simplify the notation, events types are labeled by letters such as a : $V1_{c,o}$, b : $V2_{c,o}$, c : Pu_{f-n} , d : $V1_{o,c}$, f : $V2_{o,c}$, g : Pu_{n-f} , h : $l_{(L)}^+$, i : $h_{(L)}^+$, j : $l_{(L)}^-$, k : $h_{(L)}^-$, l : $l_{(Po)}^+$, m : $h_{(Po)}^+$, n : $l_{(Po)}^-$, o : $h_{(Po)}^-$, p : $l_{(Q_{oV2})}^+$, q : $h_{(Q_{oV2})}^+$, r : $l_{(Q_{oV2})}^-$, s : $h_{(Q_{oV2})}^-$.

Scenario 1, Normal startup According to the standard procedural actions, the first event type that must occur is a : $V1_{c,o}$ (Open V1). After this event type occurrence, the system is in the mode of operation q_1 where the variable L increases and the event type h : $l_{(L)}^+$ must occur between 1 and 4 time units after that the valve $V1$ is opened,

indicating that the level of the liquid into the tank TK has passed the limit of low level. Between 1 and 4 time units after h , the liquid into the tank must arrive to the high limit of the level and the event type i : $h_{(L)}^+$ must occur. At this time point, the ordered sequence of event types that has occurred is a, h, i . The high limit of the level into the tank is the condition for continuing the procedure actions *Open V2* and *Turn ON P_u* (b : $V2_{c,o}$ and c : Pu_{f-n}). If the operator opens the valve $V2$ first, the system passes in the mode of operation q_4 , but if the pump P_u is turned ON first, the system passes in q_5 . The duration between the occurrences of event types b and c must be of 1 time unit, leaving the system in the mode of operation q_7 . At this time point, the ordered sequence of event types that has occurred must be a, h, i, b, c or a, h, i, c, b . In the *scenario1_a*: (a, h, i, c, b), the outlet pressure (P_o) of the pump P_u increases first of that the outlet flow (Q_{oV2}). Then, between 1 and 6 time units after of b , the pressure P_o has passed its limit of low pressure and the event type l : $l_{(Po)}^+$ must occur. The outlet flow after 1 unit time has passed its limit of low flow and the event type p : $l_{(Q_{oV2})}^+$ must occur. The high limit of pressure (m : $h_{(Po)}^+$) occurs between 1 and 6 time units after p and the high limit of outlet flow occurs 1 time units after m . In the *scenario1_b*: (a, h, i, b, c), the event type p occurs between 3 and 4 time units and after c . At 1 time unit after p , l must occur. After l , the event type q must occur between 3 and 4 time units and the event type m must occur 1 time unit after q . At this time point, the ordered sequence of event types that has occurred must be $a, h, i, c, b, l, p, m, q$ or $a, h, i, b, c, p, l, q, m$. In this situation, the unobservable event type M/A occurs and the control loops are closed, carrying the system to a steady state. We assume that the control loops are closed whereas q occurs in the *scenario1_a* or m in the *scenario1_b*. Then, the event type k indicates that the level of liquid in the tank TK decreases from the high limit of level, between 1 and 4 time units after that the control loops are closed. In the same way, the outlet pressure and outlet flow decrease from its high limits (o and s) between 1 and 4 time units after that k occurs. The time units between s and o must be 1. When the event types o and s occur, we assume that the startup stage, finish correctly and the ordered sequences of event types must be $a, h, i, c, b, l, p, m, q, k, o, s$ or $a, h, i, b, c, p, l, q, m, k, s, o$.

For this scenario, we chose the representative event sequences (Sp_1 , Sp_2 and Sp_3) that represent the extreme behaviors with all the possible sequence order of event types.

$$Sp_1 = \langle (a, 6), (h, 7), (i, 8), (c, 9), (b, 10), (l, 11), (p, 12), (m, 13), (q, 14), (k, 15), (o, 16), (s, 17) \rangle$$

$$Sp_2 = \langle (a, 1), (h, 3), (i, 6), (b, 7), (c, 8), (p, 12), (l, 13), (q, 17), (m, 18), (k, 22), (s, 26), (o, 27) \rangle$$

$$Sp_3 = \langle (a, 1), (h, 5), (i, 7), (b, 8), (c, 9), (p, 12), (l, 13), (q, 16), (m, 17), (k, 21), (s, 24), (o, 25) \rangle$$

The simulation of a *normal startup* is presented in Fig. 6 where we can see the evolution of the variables L in color blue, P_o in color green and $Q_o(V2)$ in color red. This simulation represents only one possible situation in this scenario related with the pattern sequence Sp_1 .

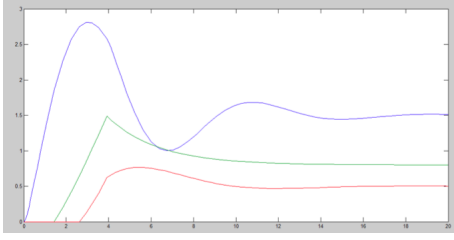

Fig. 6. Simulation of a normal startup

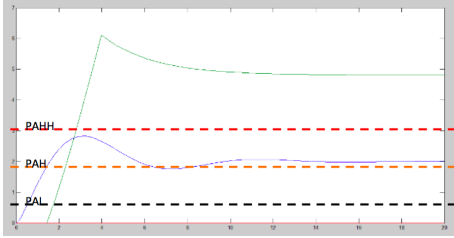

Fig. 7. Simulation of a startup with a failure in V2

Scenario 2, Abnormal startup This abnormal situation is related to a failure in the valve V2. In this scenario the sequences of event types are the same that the event sequences of a normal startup, until that is detected that the outlet flow in the system does not increase. When the level of liquid in the tank TK arrived to its high limit, the ordered sequence of event types that has occurred must be a, h, i, c, b or a, h, i, b, c . In *scenario2_a*: (a, h, i, c, b) the event type l occurs after 1 time units of b . In *scenario2_b*: (a, h, i, b, c) the event type l occurs after 2 time units of c . The event type m occurs between 1 and 2 time units after l , then the ordered sequences of event types must be a, h, i, c, b, l, m or a, h, i, b, c, l, m . For this scenario, we chose the representative event sequences (Sp_4 , Sp_5 and Sp_6) that show the extreme behaviors with all the possible sequence order of event types.

$$Sp_4 = \langle (a, 6), (h, 7), (i, 8), (c, 9), (b, 10), (l, 11), (m, 12) \rangle$$

$$Sp_5 = \langle (a, 1), (h, 3), (i, 6), (b, 7), (c, 8), (l, 10), (m, 12) \rangle$$

$$Sp_6 = \langle (a, 1), (h, 3), (i, 7), (b, 8), (c, 9), (l, 11), (m, 13) \rangle$$

The simulation of this *abnormal startup* is presented in Fig. 7 where we can see the evolution of the variables L in the color blue and Po in color green. The variable $Q_o(V2)$ (in red in Fig 6) does not appear because the valve V2 failed. The limits PAL , PAH and $PAHH$ correspond to the alarms of low, high and high high pressure. This simulation represents only one possible situation in this scenario related with the pattern sequence Sp_4 .

4.6 Heuristic Chronicle Discovery Algorithm Modified HCDAM

The chronicle exploration process corresponds in discovering all the chronicles, whose instances occur in a given temporal sequence of event types. In many cases the same situation does not implies temporal sequences perfectly identical. The *HCDAM* learns the chronicles, whose instances occur in all temporal sequences represented exhibiting the same situation (Subias et al. (2014)). Given a set of temporal sequences and a minimum frequency threshold, it finds all minimal frequent chronicles pre-

sented in all temporal sequences. The chronicle learning algorithm has the following two phases:

- (1) It builds a constraint database from a set of the temporal sequences (\mathbb{S}) where it stores for each pair of event types its temporal constraints in a constraint graph structure.
- (2) It generates a set of candidate chronicles initializing with a set of chronicles that were proved to be frequent and it uses the constraint database to explore the chronicle space.

The base of the chronicles stores for each pair of event types its temporal constraints in a constraint graph structure. In this graph, time constraints are nodes of an acyclic graph whose arcs represent the relationship *is parent of*. Which is defined as:

Definition 2: The node $e_i[t^-, t^+]e_j$ is parent of another $e_i[t'^-, t'^+]e_j$ if, only if $[t'^-, t'^+] \subset [t^-, t^+]$ and not exist $e_i[t''^-, t''^+]e_j$ such that $[t'^-, t'^+] \subset [t''^-, t''^+] \subset [t^-, t^+]$

Definition 3: The graph of constraints is defined as the tuple $GC = (\varepsilon, \tau, \mathcal{G}_c)$ containing time constraints, which are nodes in an oriented acyclic graph whose arcs represent the inclusion relations of the constraints. $\varepsilon \subseteq E$ with $\forall e_i \in E, e_i \subseteq_{\leq} e_{i+1}$: A finite set of event types is called the typology of the constraint graph. $\mathcal{T} = \{\tau_1, \tau_2, \dots, \tau_p\}$ is the set of time constraints of the chronicle. $\mathcal{G}_c = (\mathcal{T}, \mathcal{A}_c)$ is a directed graph whose nodes represent the time constraints valid for a given frequency and the arcs \mathcal{A}_c represent the relationships *is parent of*. As this analysis is for several sequences, only the pairs of event types which are present in all sequences, are processed. This leads us to the first stage of the constraint graph construction that it is the *filtering operation*. **Definition 4:** The *filtering operation* is a preliminary treatment on sequences and it can be summarized in two possible actions: 1. Filtering the event types not present in all sequences \mathbb{S} . If $\exists S_k \in \mathbb{S}$ such as $\exists e_i \notin S_k$, then e_i will be removed of all other sequences. 2. Filtering on a given set of event types $\varepsilon = \{e_i, e_j, \dots, e_k\}$ if we are interested only those event types during processing. This option will be useful when we want to learn the patterns of a subset of event types.

5. CONSTRUCTION OF THE CHRONICLE DATABASE

An industrial or complex process Pr is composed of different areas $Pr = \{Ar_1, Ar_2, \dots, Ar_n\}$ where each area Ar_k has different operational modes such as startup, shutdown, etc. The set of chronicles $\{C_{ij}^k\}$ for each area Ar_k is presented in the matrix below, where the rows represent the operating modes (i.e. O_1 : *Startup*, O_2 : *Shutdown*, etc) and the columns the normal and abnormal situations.

$$CAr_k = \begin{matrix} & N & f_1 & f_2 & \dots & f_n \\ O_1 & \begin{bmatrix} C_{01}^k & C_{11}^k & C_{21}^k & \dots & C_{i1}^k \end{bmatrix} \\ O_2 & \begin{bmatrix} C_{02}^k & C_{12}^k & C_{22}^k & \dots & C_{i2}^k \end{bmatrix} \\ \dots & \dots & \dots & \dots & \dots & \dots \\ O_j & \begin{bmatrix} C_{0j}^k & C_{1j}^k & C_{2j}^k & \dots & C_{ij}^k \end{bmatrix} \end{matrix} \quad (7)$$

This chronicle database, is to be submitted to a chronicle recognition system that identifies in an observable flow of events all the possible matching with the set of chronicles from which the situation (normal or faulty) can be

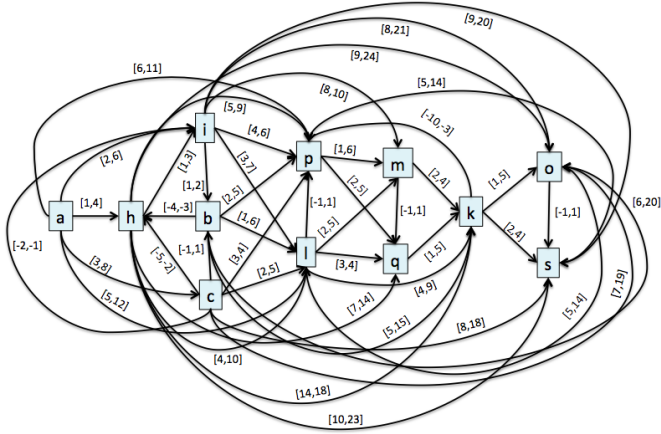

Fig. 8. Chronicle C_{01}^1 resulted using the *HCDAM* in the normal startup scenario

assessed. In the following subsection are presented two chronicles (C_{01}^1 and C_{11}^1) of the set of chronicles of the HTG (Hydrostatic Tank Gauging) system i.e of the area Ar_1 of the whole system. C_{01}^1 is a chronicle describing the normal star up stage of the *HTG* and C_{11}^1 is associated to failure behavior of type f_1 during a startup stage.

5.1 Using *HCDAM*

We present two chronicles (C_{01}^1 and C_{11}^1) of the set of chronicles of the HTG (Hydrostatic Tank Gauging) system i.e of the area Ar_1 of the whole system. C_{01}^1 is a chronicle describing the normal start up stage of the *HTG* and C_{11}^1 is associated to failure behavior of type f_1 during a startup stage.

Scenario 1, Normal startup: The chronicle C_{01}^1 that resulted using the algorithm *HCDAM* is presented in Fig. 8. The pattern event sequences used are the Sp_1 , Sp_2 and Sp_3 generated in section IV.

Scenario 2, Abnormal startup: The chronicle C_{11}^1 that resulted using the algorithm *HCDAM* is presented in Fig. 9. The representative event sequences used are the Sp_4 , Sp_5 and Sp_6 generated in section IV. Similar to the language theory, in the chronicles the alphabet corresponds to E . The timed language $\mathcal{L}^T(\xi, \mathcal{T})$ of each chronicle C will be referenced in the strings w that can be generated according to the typology of the chronicle and the concatenation of the elements in the strings will be restricted by the set of temporal constraints \mathcal{T} .

6. CONCLUSION

A preliminary method for alarm management based on a diagnosis process has been proposed. The proposal is based on a hybrid causal model of the system and a chronicle based approach for diagnosis. An illustrative example of an hydrostatic tank gauging has been considered to introduce the main concepts of the approach. The algorithm *HCDAM* is a tool for the automatic generation of the chronicles from representative event sequences. Transposing this methodology to large-scale systems would benefit from a decentralized approach in which local chronicles

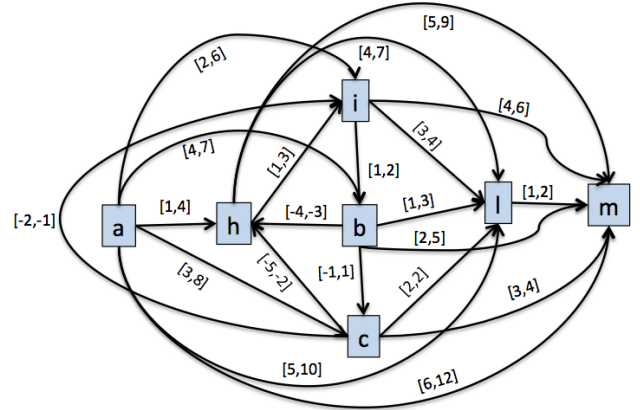

Fig. 9. Chronicle C_{11}^1 resulted using the *HCDAM* in the abnormal startup scenario

would be learned and then integrated thanks to shared events.

ACKNOWLEDGEMENTS

The ECOPETROL - ICP engineers Jorge Prada, Francisco Cala and Gladys Valderrama help us to develop and validate the simulations.

REFERENCES

- Beebe, D., Ferrer, S., and Logerot, D. (2013). The connection of peak alarm rates to plant incidents and what you can do to minimize. *Process Safety Progress*.
- Bhagwat, A., Srinivasan, R., and Krishnaswamy, P.R. (2003). Fault detection during process transitions: a model-based approach. *Chemical Engineering Science* 58 (2003) 309 - 325.
- Jing, Z., Boang, L., and Hao, Y. (2013). Fault diagnosis strategy for startup process based on standard operating procedures. *25th Chinese Control and Decision Conference (CCDC)*.
- Pons, R., Subias, A., and Travé-Massuyès, L. (2015). Iterative hybrid causal model based diagnosis: Application to automotive embedded functions. *Engineering Applications of Artificial Intelligence*.
- S. Xu, A. Adhitya, R.S. (2014). Hybrid model-based framework for alarm anticipation. *Industrial & Engineering Chemistry Research*.
- Srinivasan, R., Viswanathan, P., Vedam, H., and Nochur, A. (2005). A framework for managing transitions in chemical plants. *Computers & Chemical Engineering*, 29, 305-322.
- Subias, A., Travé-Massuyès, L., and LeCorronc, E. (2014). Learning chronicles signing multiple scenario instances. *IFAC World Congress, Le Cap, South Africa, 26-29 August*.
- Vasquez, J., Travé-Massuyès, L., Subias, A., Jimenez, F., and Agudelo, C. (2015). Chronicle based alarm management in startup and shutdown stages. *International Workshop on Principles of Diagnosis (DX-2015), Paris*.
- Zhu, J., Shu, Y., Zhao, J., and Yang, F. (2014). A dynamic alarm management strategy for chemical process transitions. *Journal of Loss Prevention in the Process Industries*.