

# Large-area graphene synthesized by catalytic CVD: towards biosensor microdevices

**Loïc Assaud**

**H. Vergnes, D. Evrard, L. Salvagnac, V. Conédéra, P. Gros, P. Temple-Boyer, B. Causat**

# Introduction: oxidative balance

## Enzymatic defense system

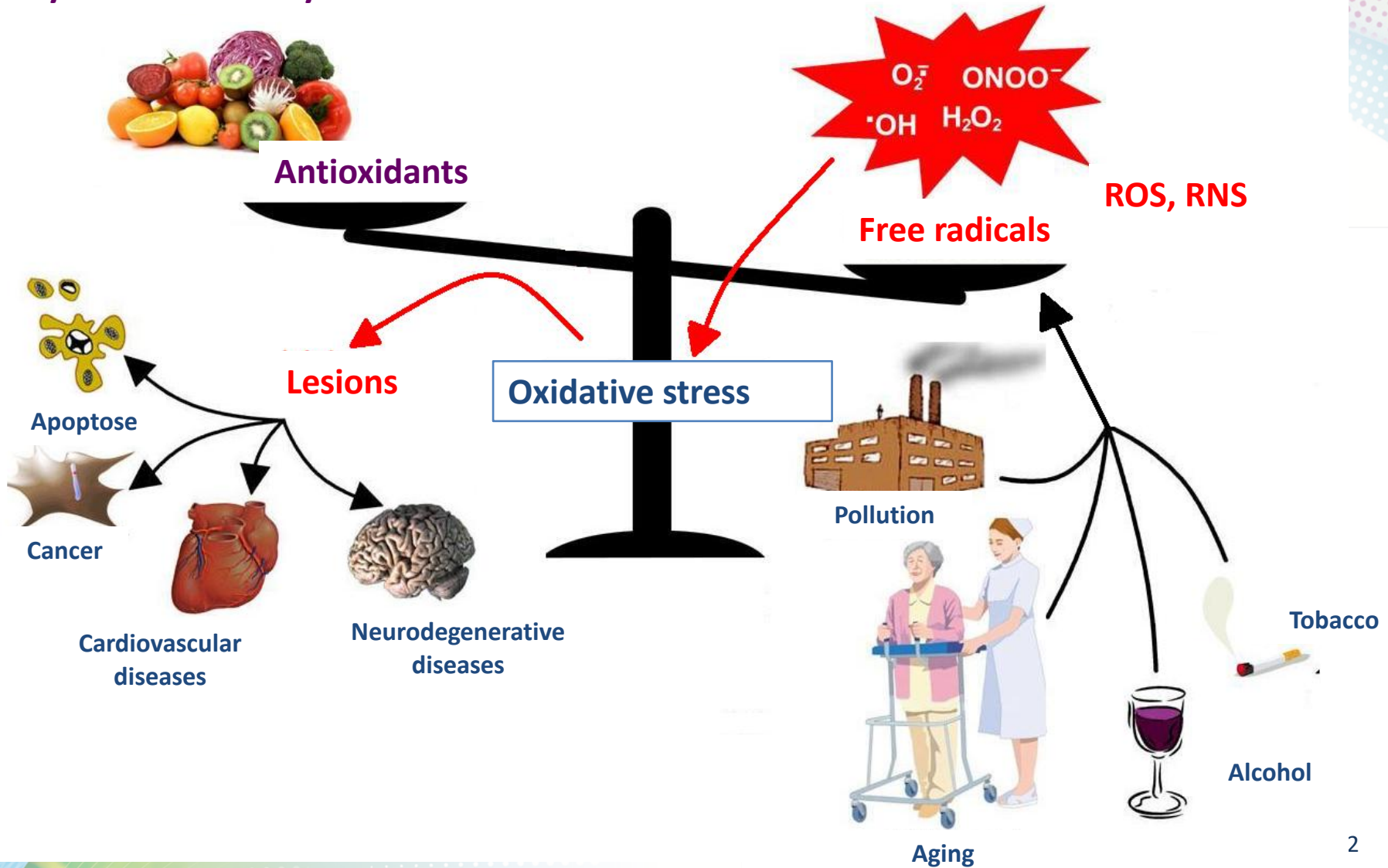



# Objectives / Strategy

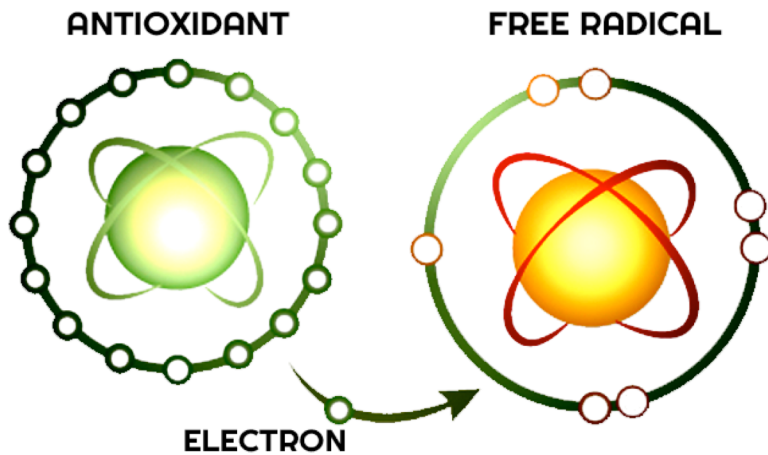

**Pathologies**

→ Electrochemical biosensors



**Glassy carbon** → no compatible with Si microtechnologies for large scale production of microsensors



**Functionalized electrode** → life-time, sensitivity, selectivity, limit of detection

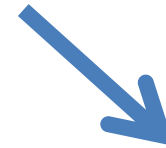

Utilization of graphene-based electrode



Integration of the electrode in a microdevice

# Catalytic CVD

- Graphene deposition parameters:

- Pt catalyst
- $T = 1040^{\circ}\text{C}$
- Atmospheric pressure
- Carbon feedstock:  $\text{CH}_4$
- Thermal pretreatment
- Reductive  $\text{H}_2$  atmosphere

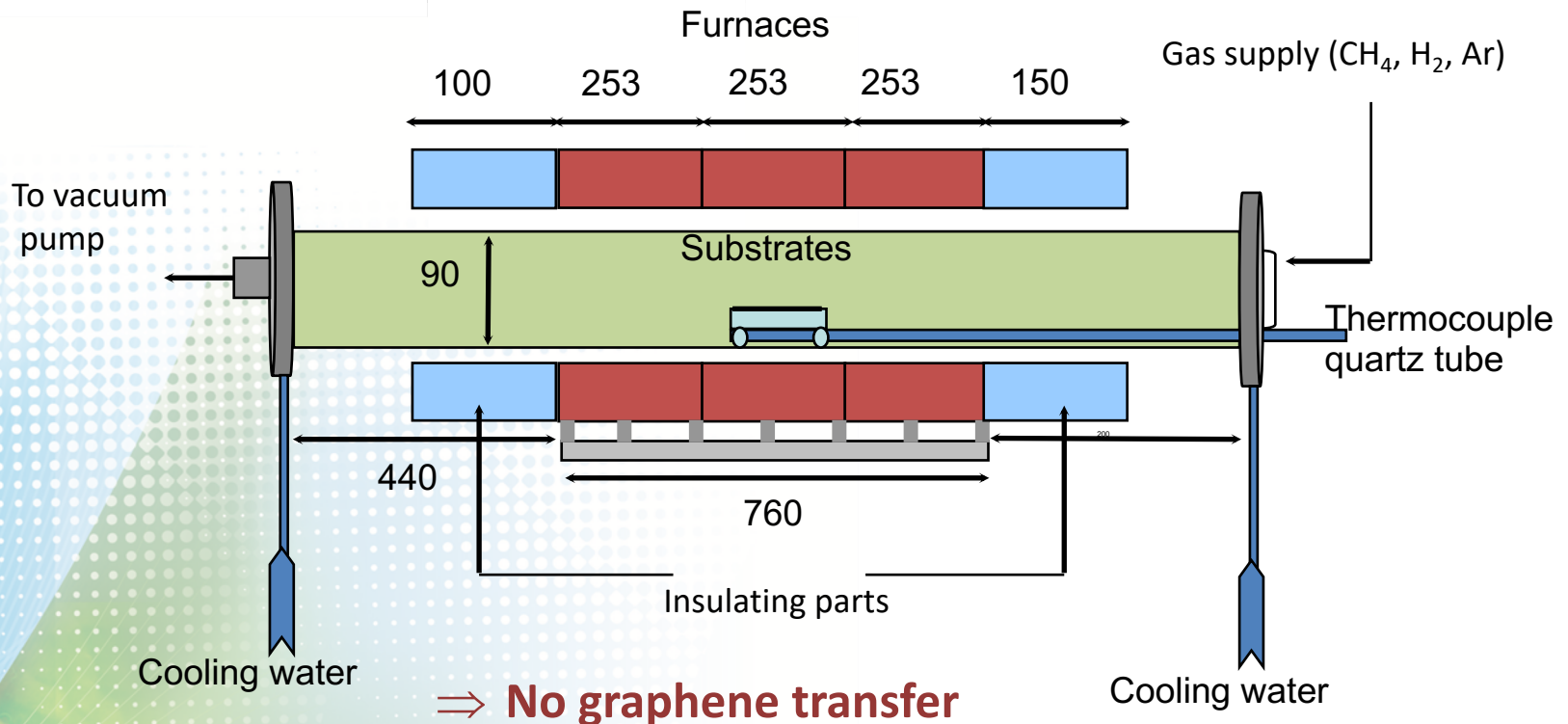
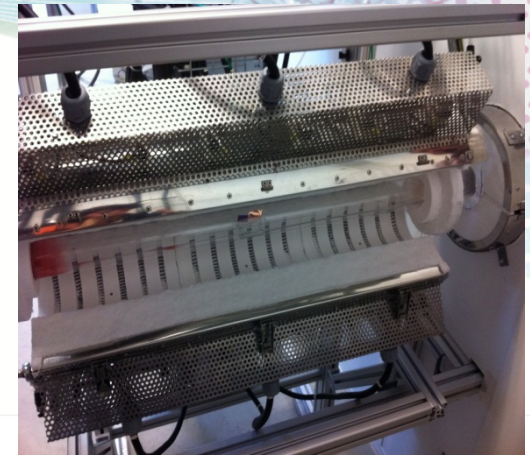



# Graphene / Pt foil

SEM

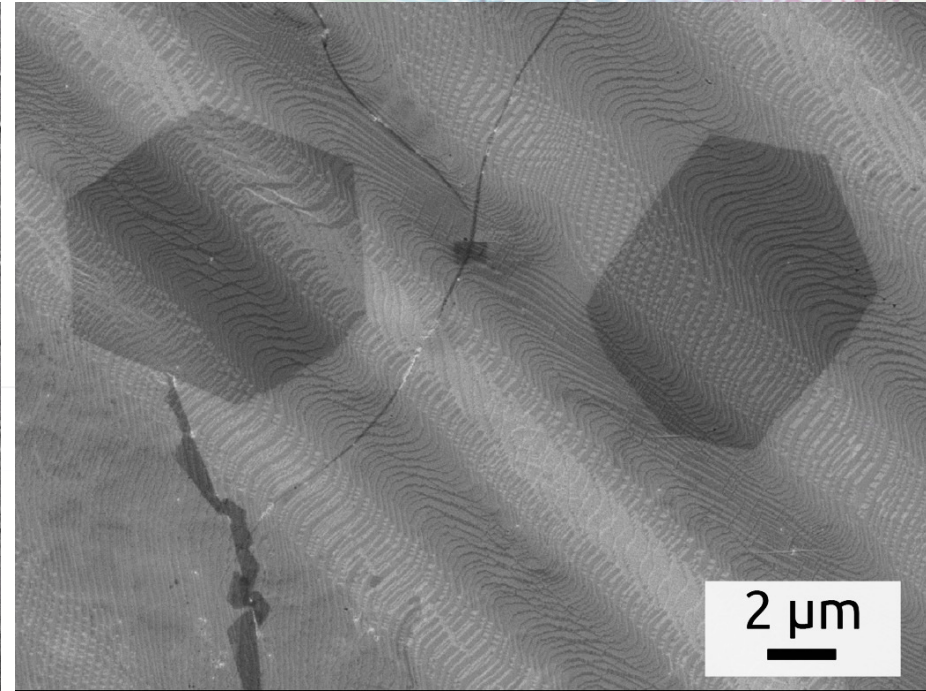
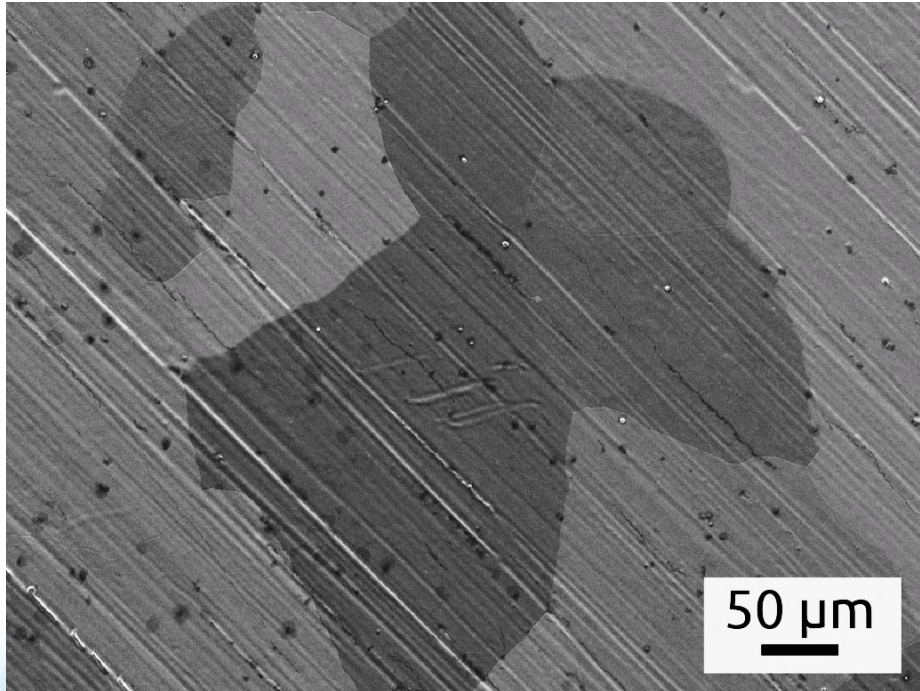

- **Parameters:**

- Pt foil (100-μm thick)
- Thermal pretreatment: 15 min
- Deposition duration: 12 min
- CH<sub>4</sub>: 5 sccm

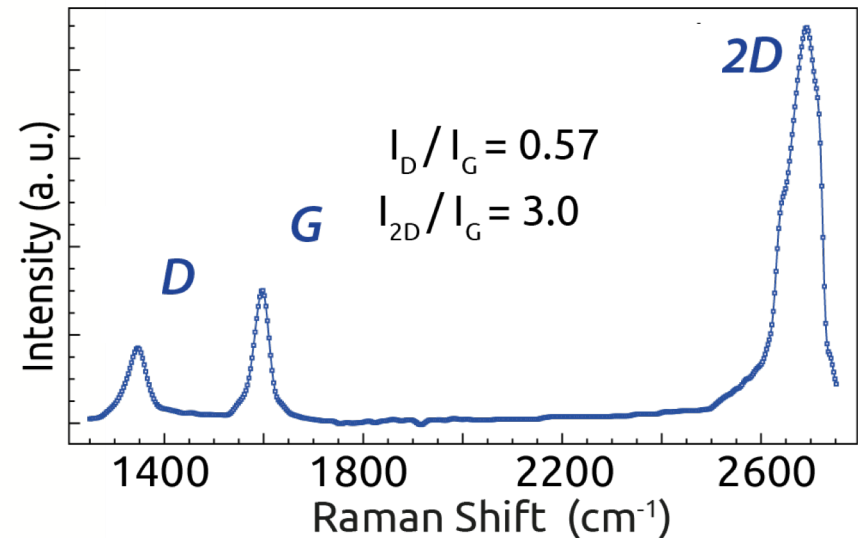



# Graphene / Pt foil

SEM

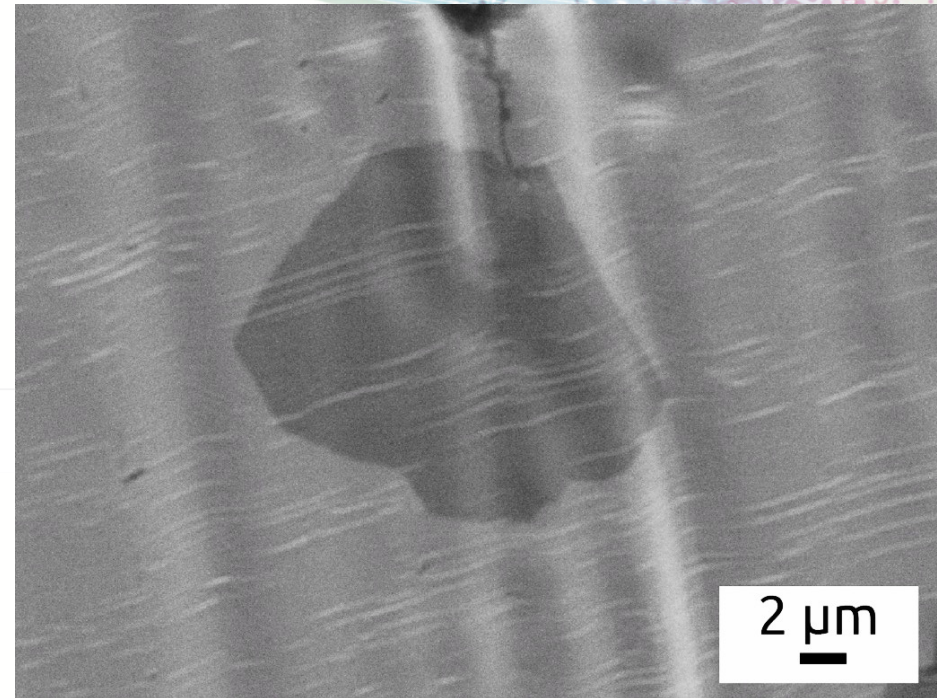
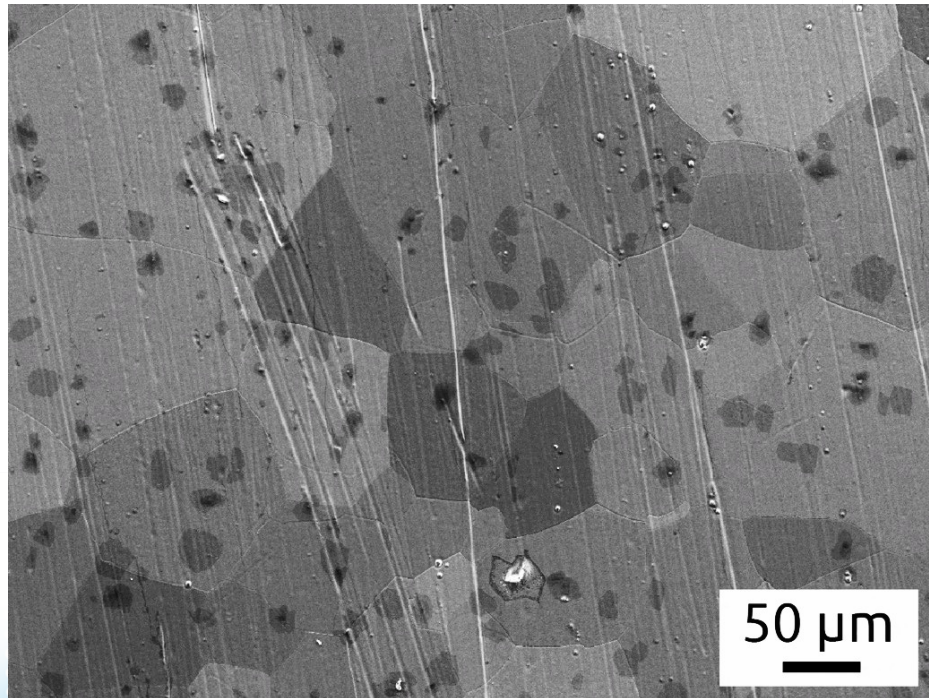

- **Parameters:**

- Pt foil (100-μm thick)
- Thermal pretreatment: 15 min
- Deposition duration: 24 min
- CH<sub>4</sub>: 5 sccm

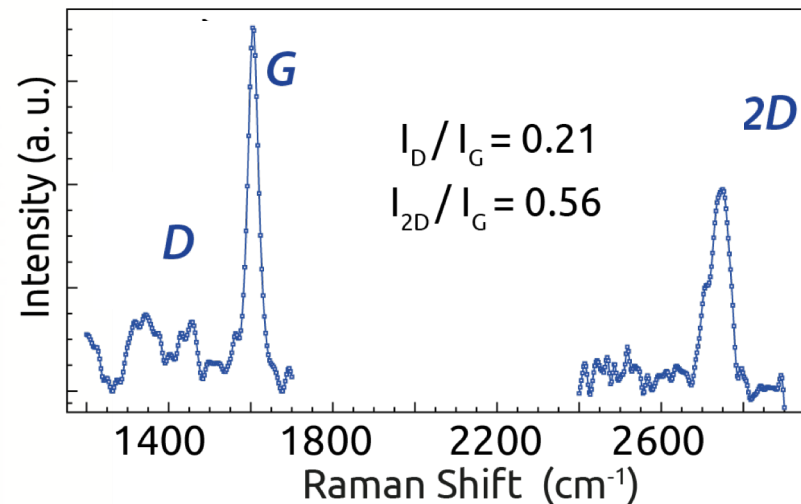

# Pt thin films

- **Parameters:**

- Pt (200 nm) / SiO<sub>2</sub>-Si
- Thermal pretreatment: 15 min
- Deposition duration: 12 min
- CH<sub>4</sub>: 5 sccm

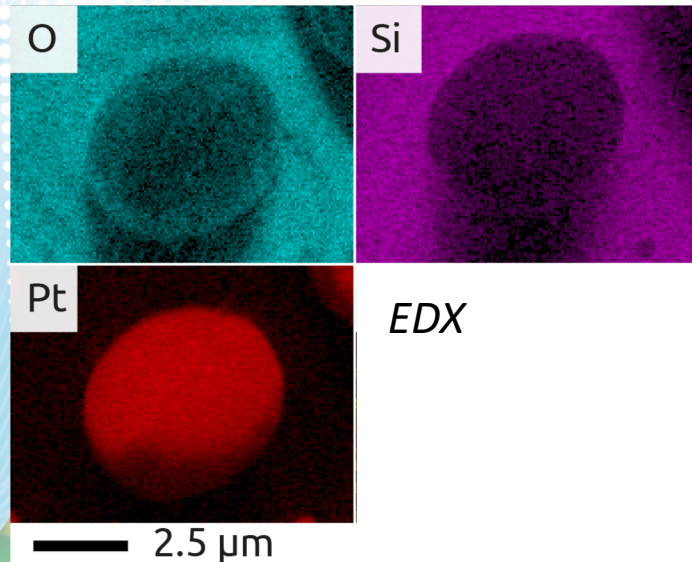
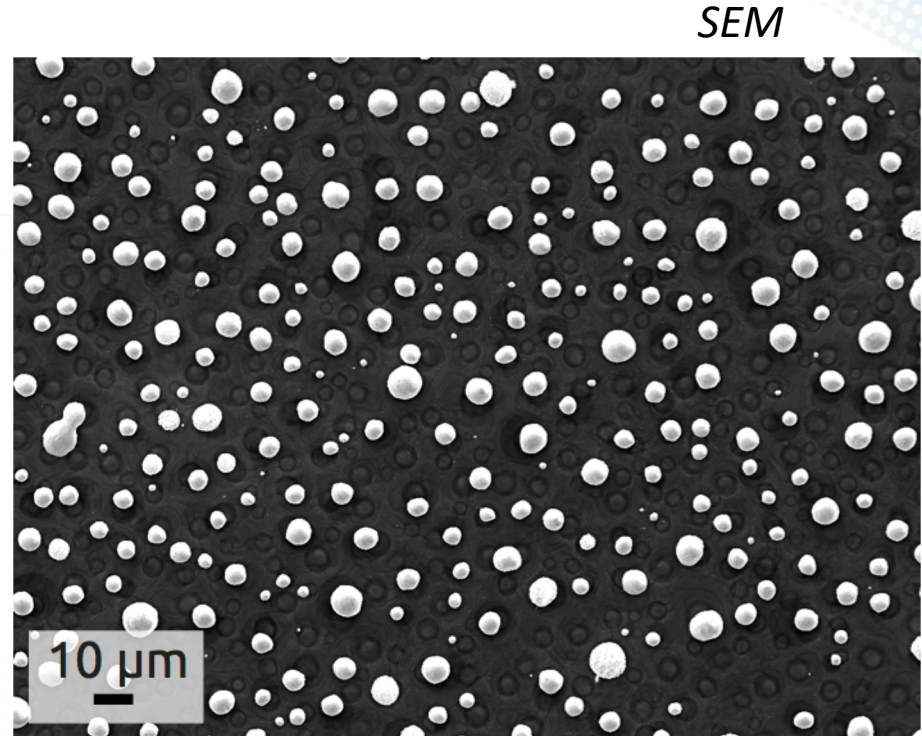
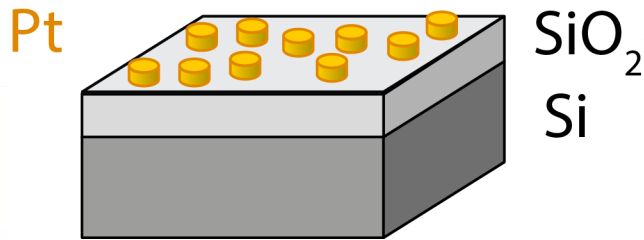

⇒ Dewetting of the Pt thin film



# Graphene / Pt thin films

SEM

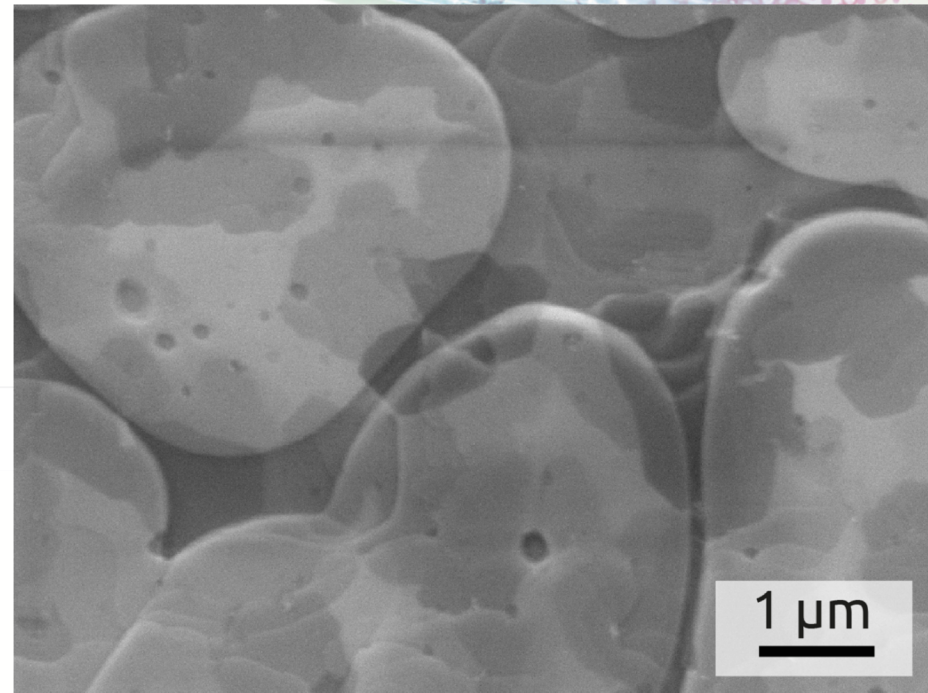
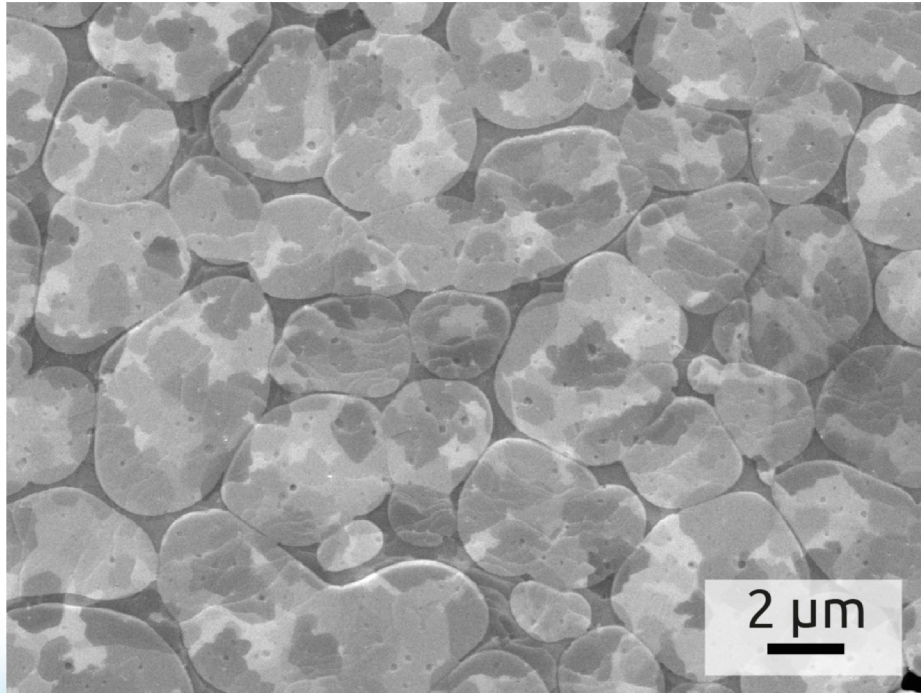

⇒ Interlayer: Ti ⇒ Ta

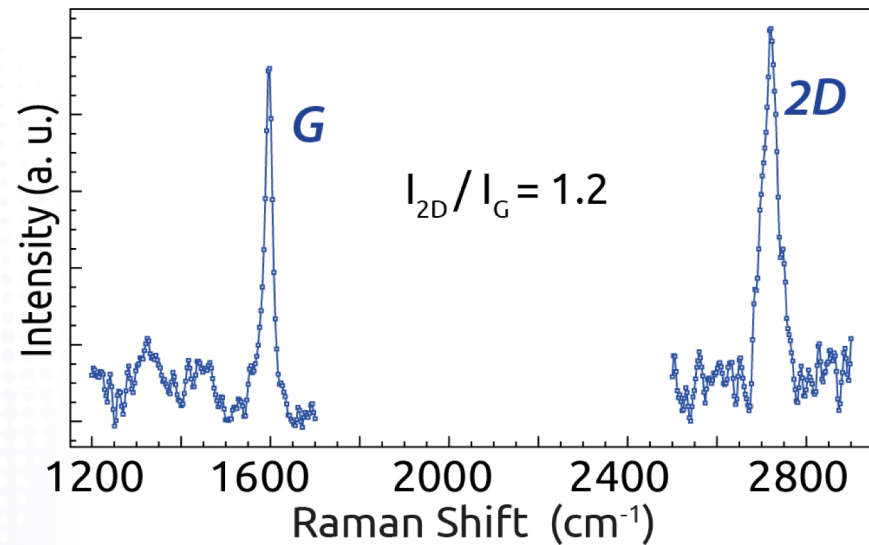
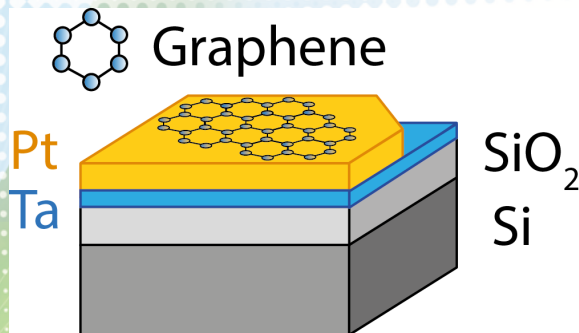



# Graphene flakes

- **Parameters:**
  - Pt (200 nm) / Ta (20 nm) / SiO<sub>2</sub>-Si
  - Thermal pretreatment: 15 min
  - Deposition duration: 12 min
  - CH<sub>4</sub>: 5 sccm

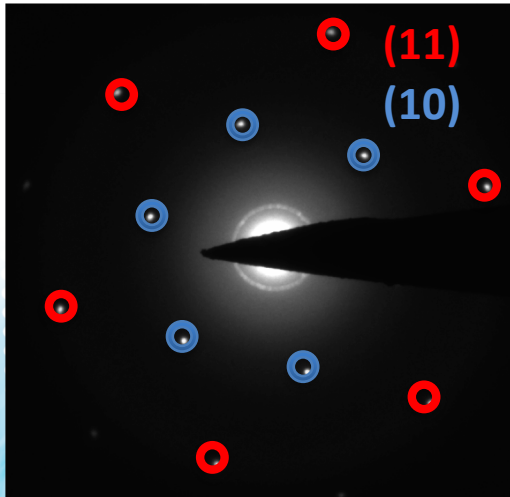
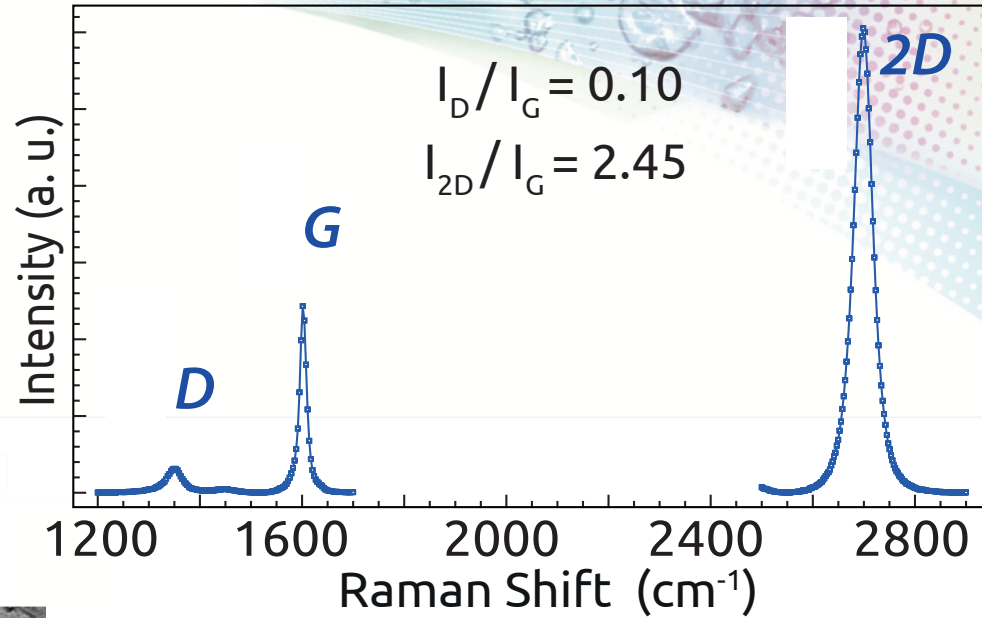

TEM

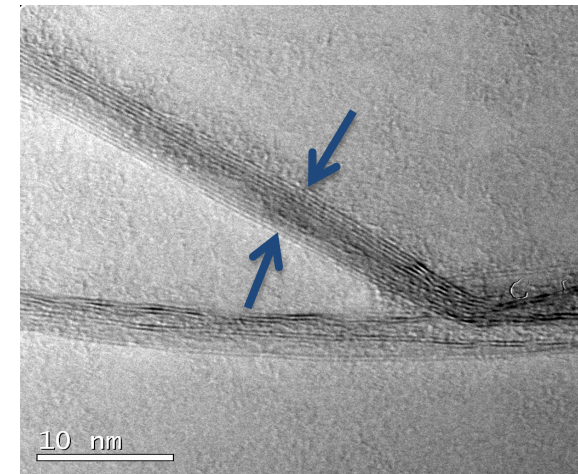
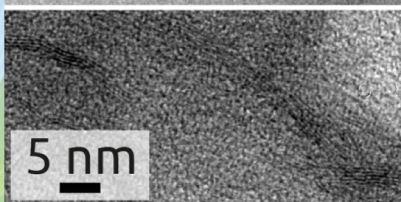
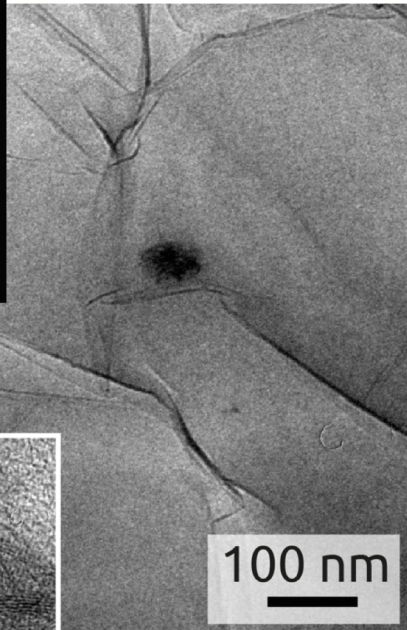

- ⇒ High quality graphene
- ⇒ Few monolayers

# Graphene-based sensors

- **Graphene-based electrode functionalization:**
  - Electro-grafting of 4-thiophenylbenzene diazonium
  - Electropolymerization of EDOT

**Step #1 :**  
Diazonium grafting

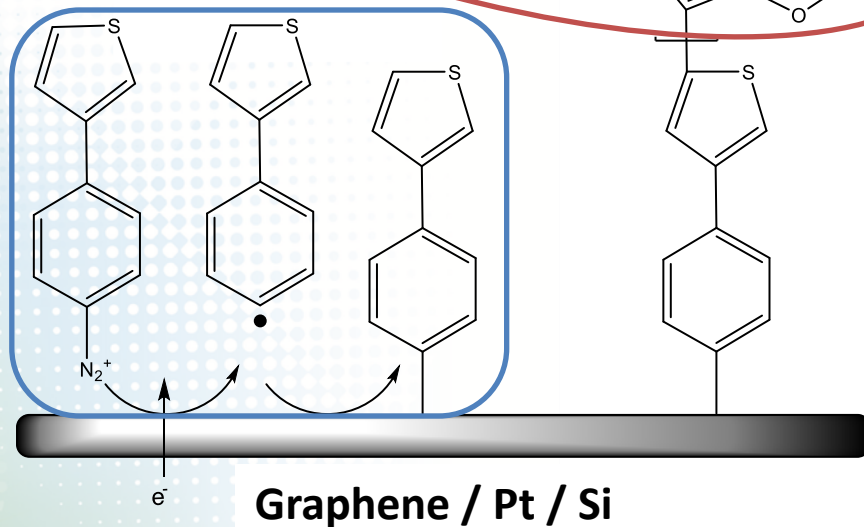

**Step #2 :**  
EDOT electropolymerization

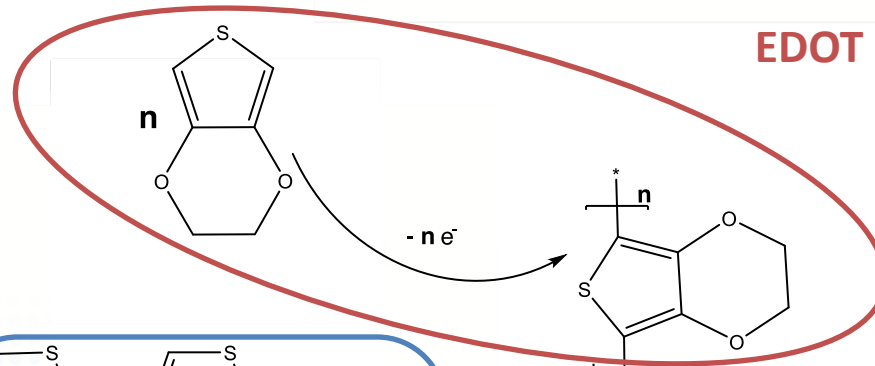

# Electrochemical activity

- Graphene-based electrode cycling in phosphate buffer electrolyte:

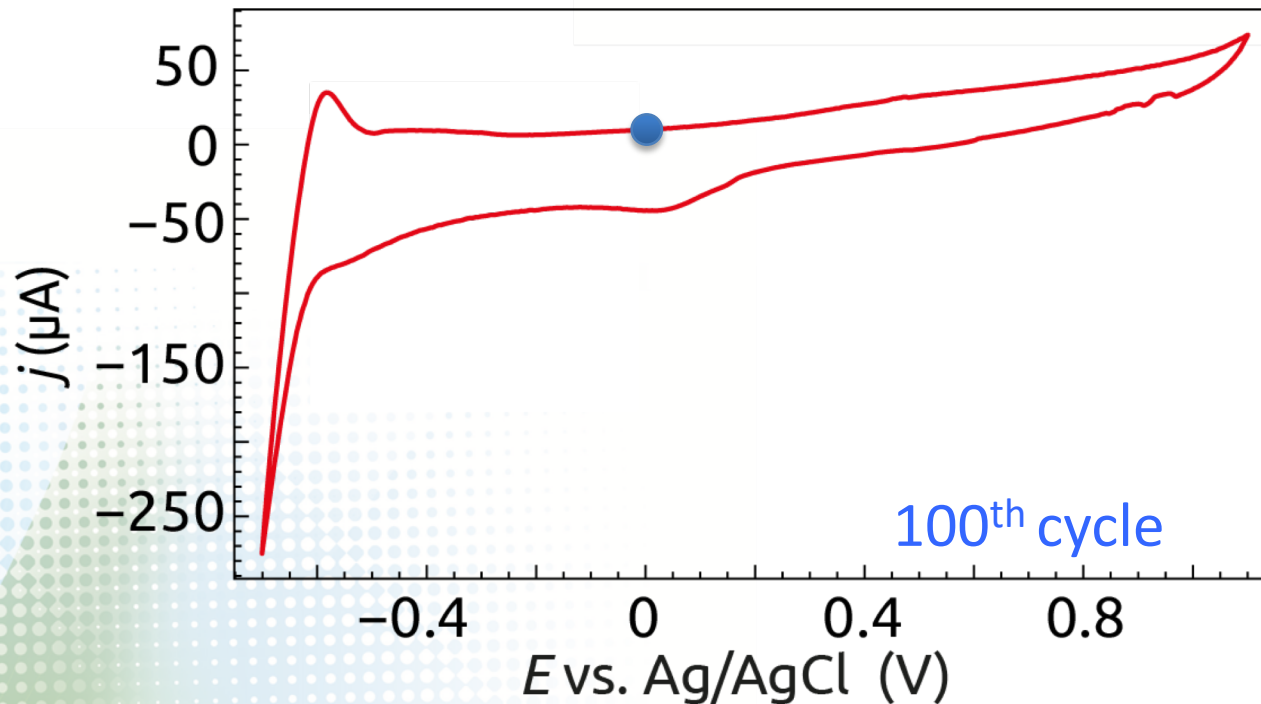

⇒ **Sability of the graphene electrode over 100 cycles.**



# Graphene electrode

- **Electrochemical functionalization**

## Step #1: Diazonium salt electrografting

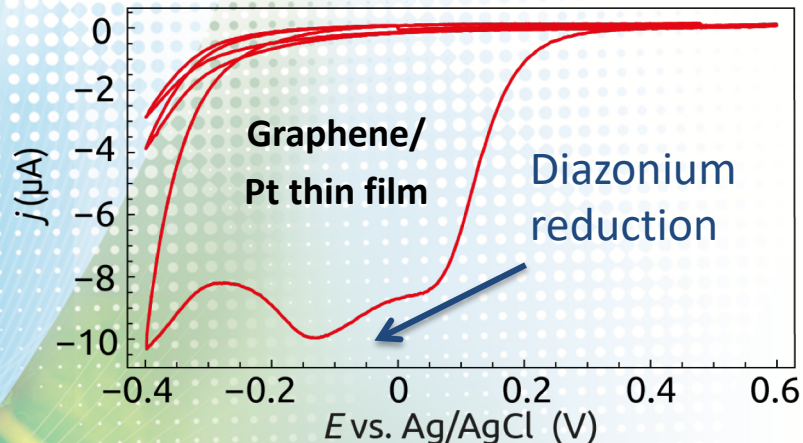
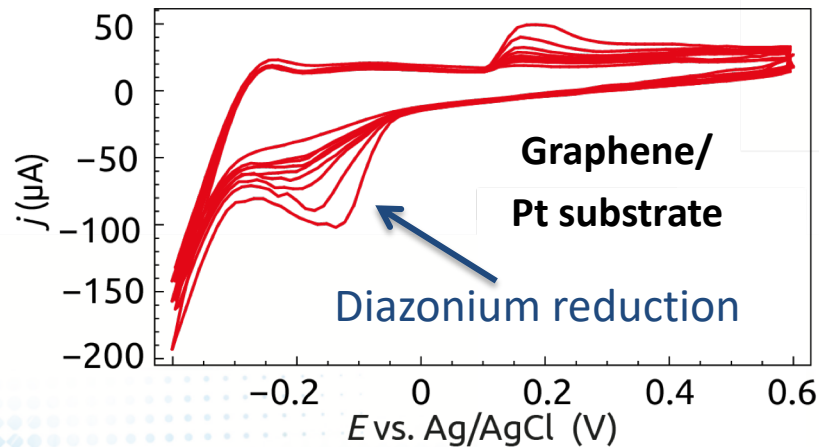

## Step #2: Electropolymerization of EDOT

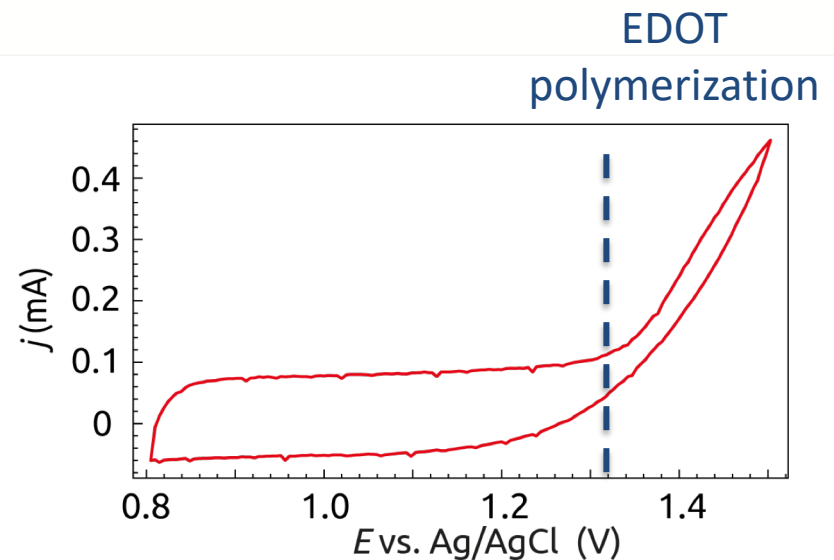

⇒ **Diazonium grafting by cyclic voltammetry until a self-limited layer has grown**

# Electrochemical activity

- **Uric acid detection**

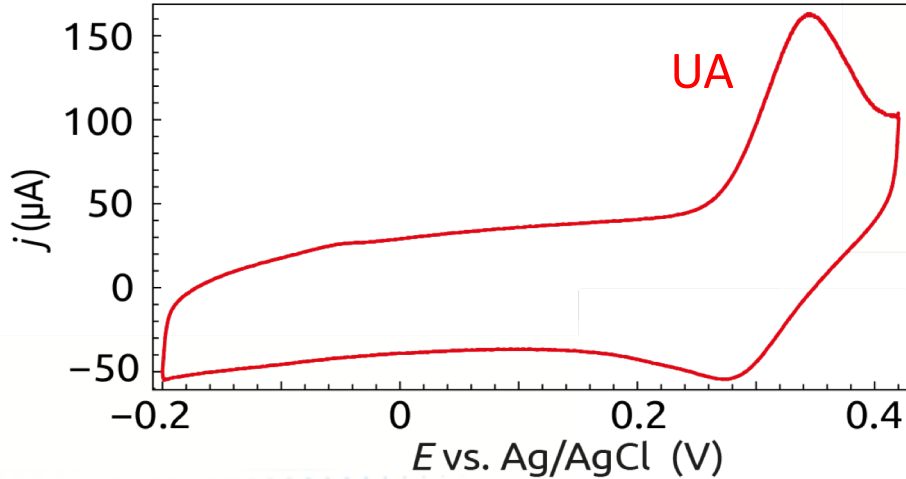

⇒ Well-defined oxidation wave attributed to UA signal

⇒ Limit of detection 200 μM

- **Simultaneous detection of uric acid and ascorbic acid**

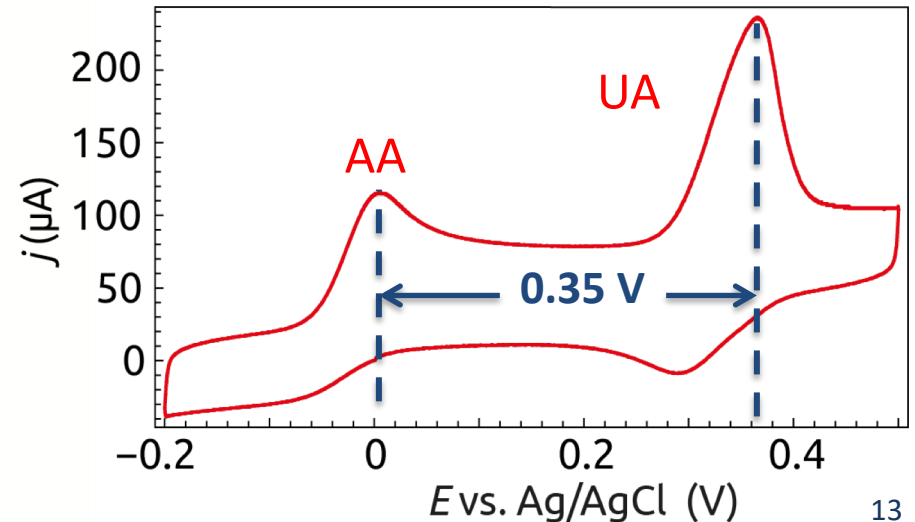

⇒ High sensitivity and selectivity

⇒ UA and AA anodic peaks potential separation: 0.35 V

⇒ Detection at low overpotentials

# Electrochemical activity

- Simultaneous detection of uric acid and ascorbic acid:

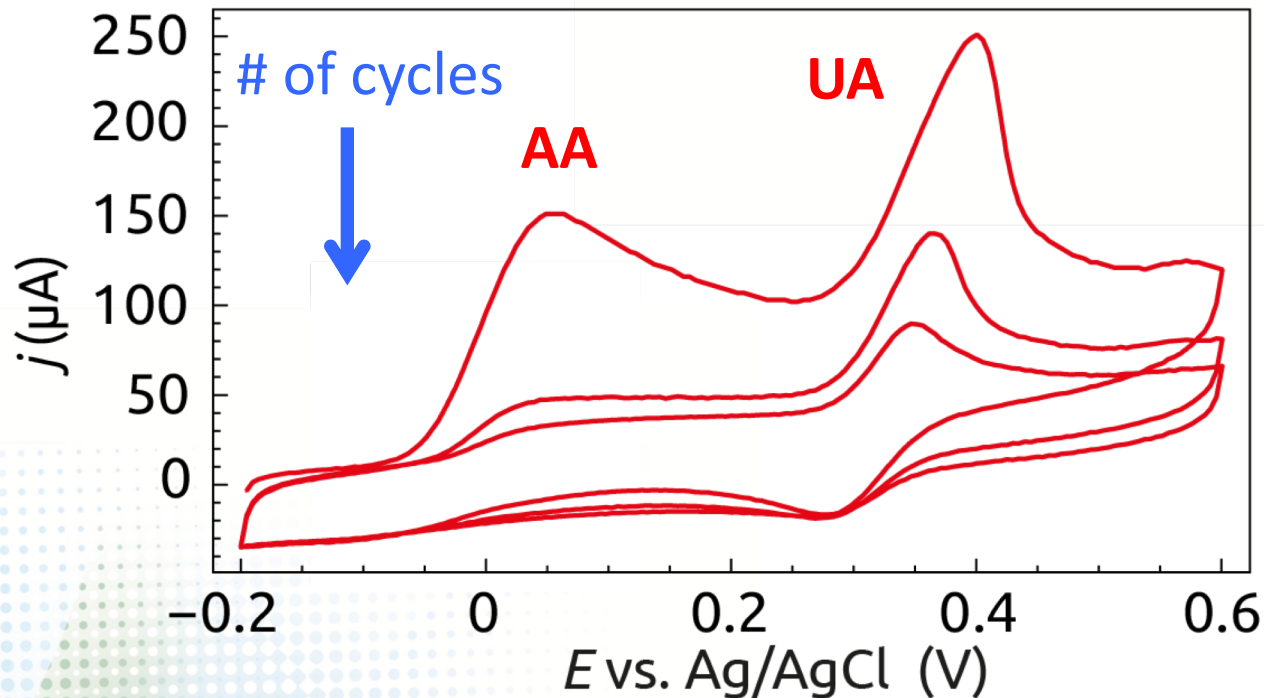

- ⇒ High selectivity
- ⇒ Decreasing of the detection signal over time
- ⇒ Reactivation of the electrode by rinsing with ethanol



# Electrochemical activity

- Uric acid detection

- Simultaneous detection of UA and AA

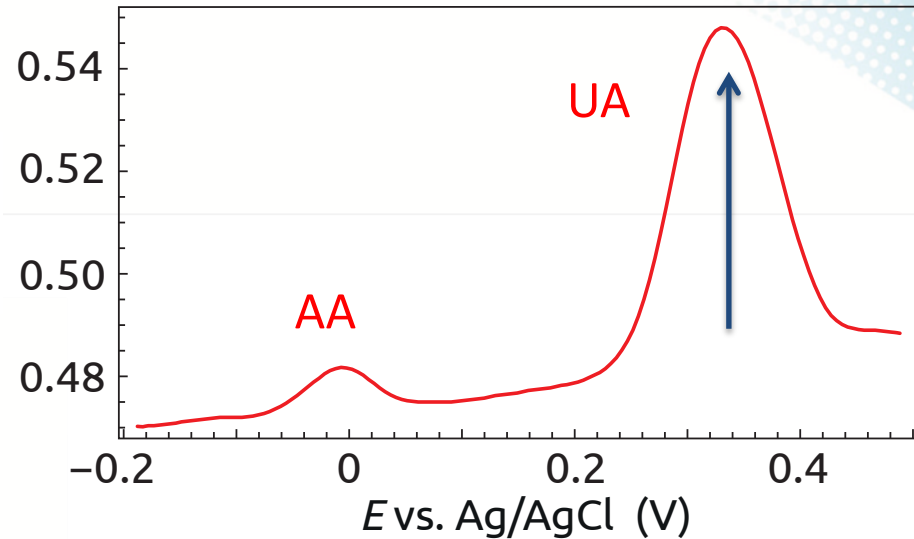
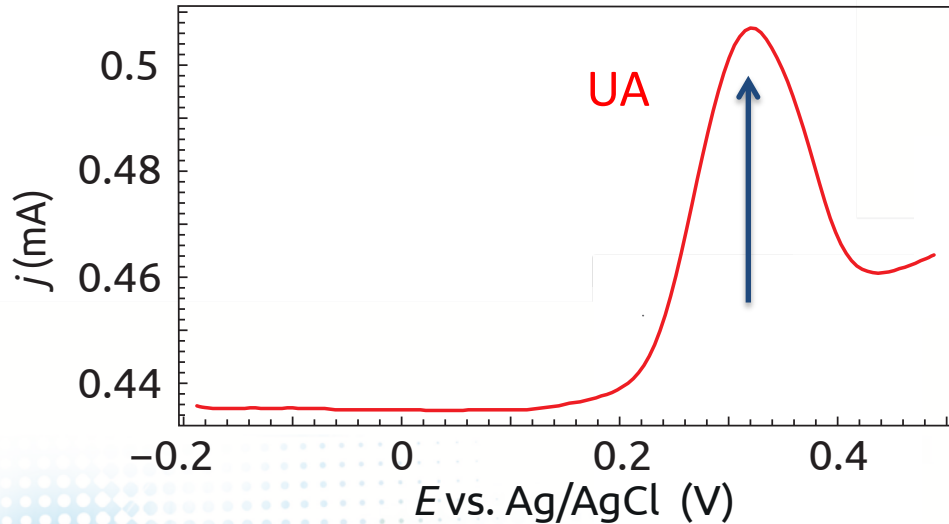

⇒ Enhancement of the UA oxidation wave while simultaneous detection of both UA and AA.

⇒ Spontaneous oxidoreduction reaction taking place between AA and UA oxidation products.

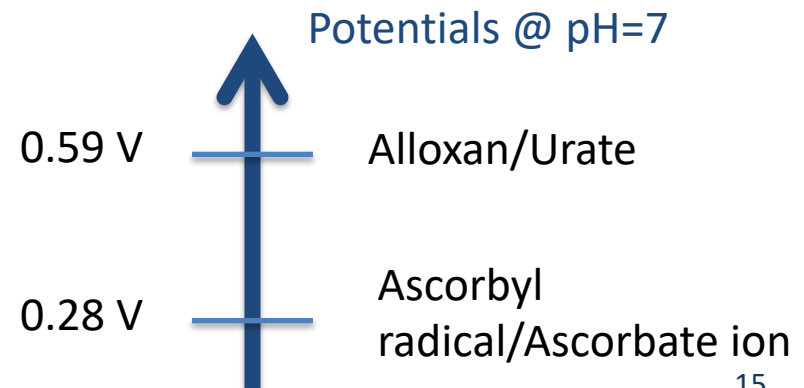

# Microdevices

- Integration of the graphene-based sensor in a microdevice:
  - Pt/Ta/SiO<sub>2</sub>/Si patterned substrate
  - Deposition of graphene (1040°C, AP, 15 min thermal treatment, 12 min deposition duration, CH<sub>4</sub>: 5 sccm)

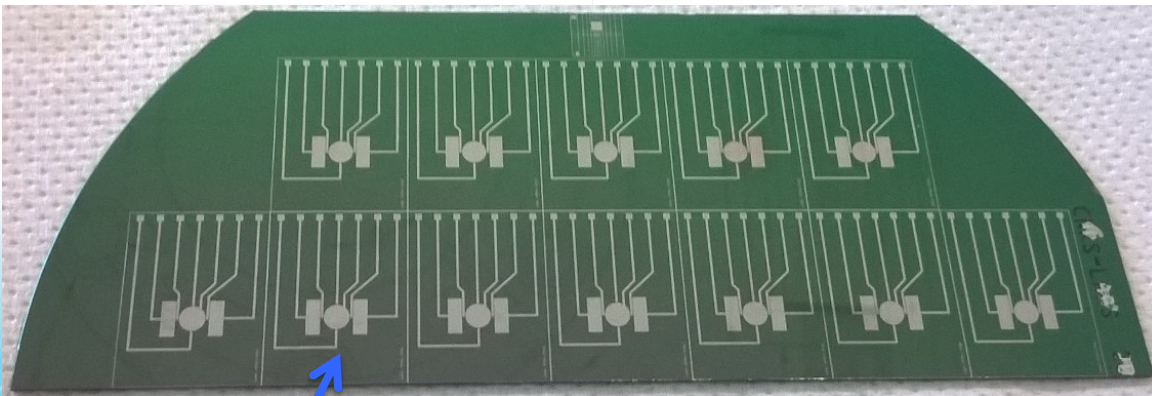

3 μ-electrodes

4 ultra-μ-electrodes

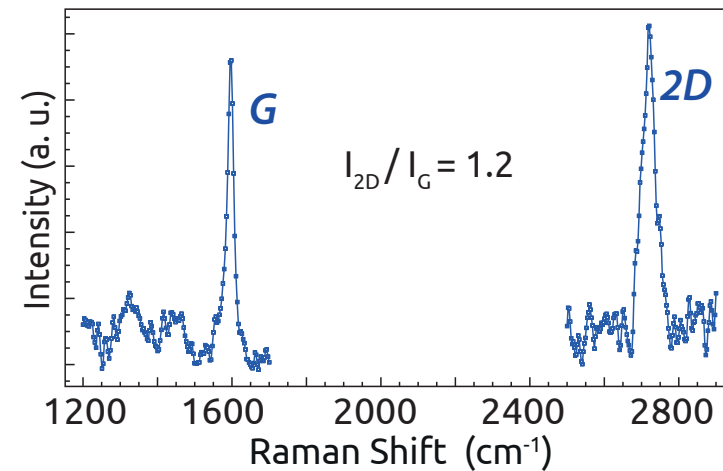
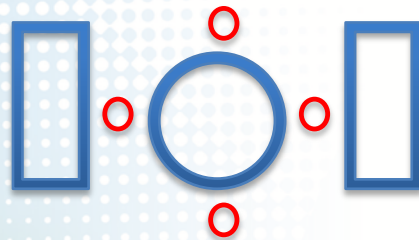

⇒ Graphene

# Microdevices

- **Integration of the sensor in a microdevice:**
  - Passivation of the electrode by  $\text{Si}_3\text{N}_4$
  - Sensor integration into the final device

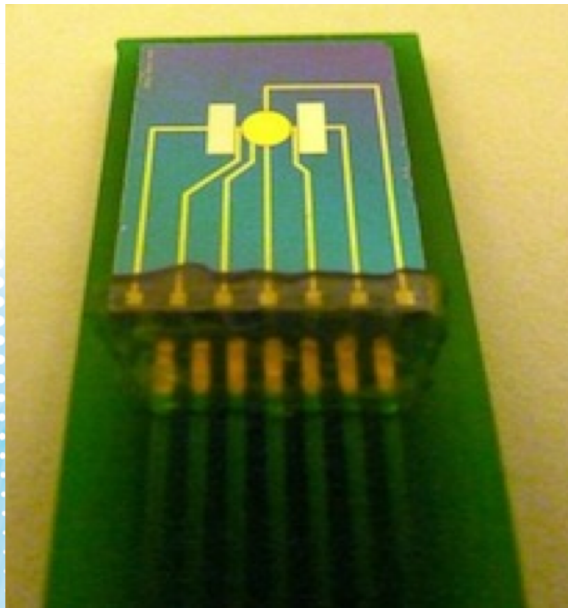

3  $\mu$ -electrodes + 4 ultra- $\mu$ -electrodes

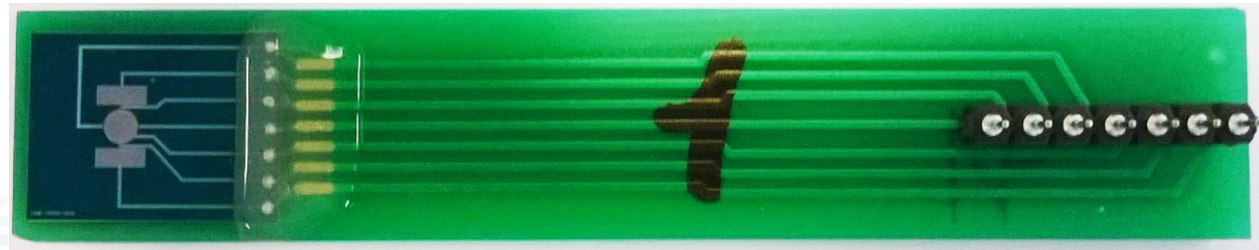

- ⇒ Up to 7 measurements on one chip
- ⇒ Electrochemical testing: in progress



# Conclusion and outlook

- Synthesis of graphene on Pt thin films.
- Functionalization of the sensor by diazonium grafting and EDOT electropolymerisation.
- Integration of the electrode into a microdevice.
- Simultaneous detection of uric acid and ascorbic acid.
  - ⇒ Optimization of the graphene quality (doping)
  - ⇒ Improvement of the limit of detection of the electrochemical sensors



# Acknowledgments

- LAAS clean room technological team
- Marc Monthioux and Laure Noé (CEMES, Toulouse)
- Michel Molinier, Etienne Prévot, Marie-Line De Solan Bethmale and Nicolas Massonnet (LGC, Toulouse)



- This work is funded by:



The background features abstract, flowing patterns in shades of blue, green, and purple. There are halftone dot patterns and some circular motifs, possibly representing water droplets or bubbles, scattered across the design. The overall aesthetic is clean and modern.

**Thank you for your attention!**

**Ευχαριστώ !**



# Large-area graphene synthesized by catalytic CVD: towards biosensor microdevices

Loïc Assaud

[loic.assaud@ensiacet.fr](mailto:loic.assaud@ensiacet.fr)

# Pt thin films

- **Parameters:**

- Pt (200 nm) / Ti (20 nm) / SiO<sub>2</sub>-Si
- Thermal pretreatment: 15 min
- Deposition duration: 12 min
- CH<sub>4</sub>: 5 sccm

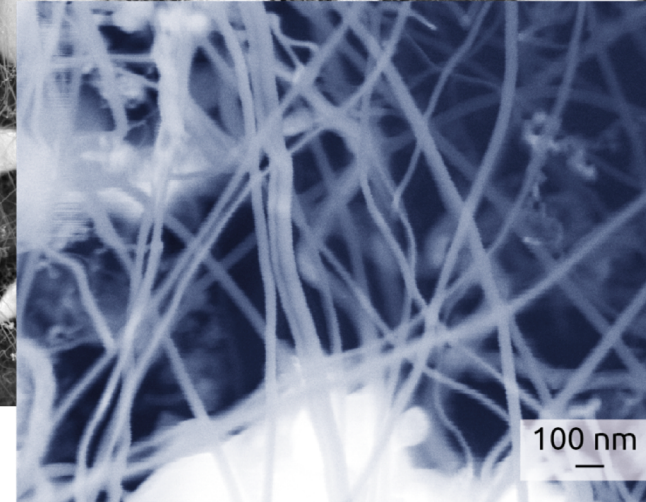
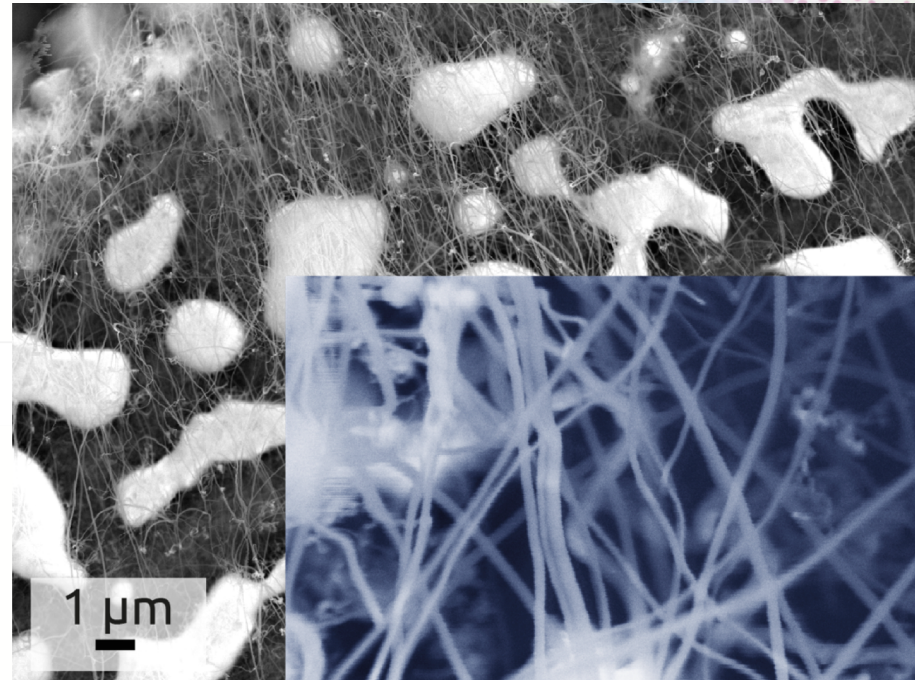
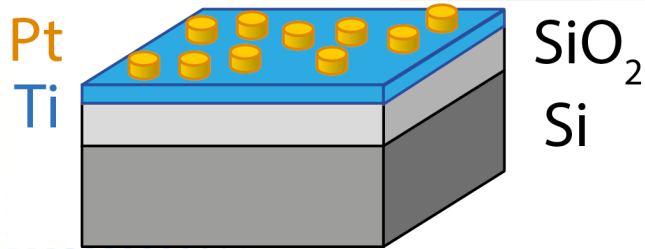

TEM

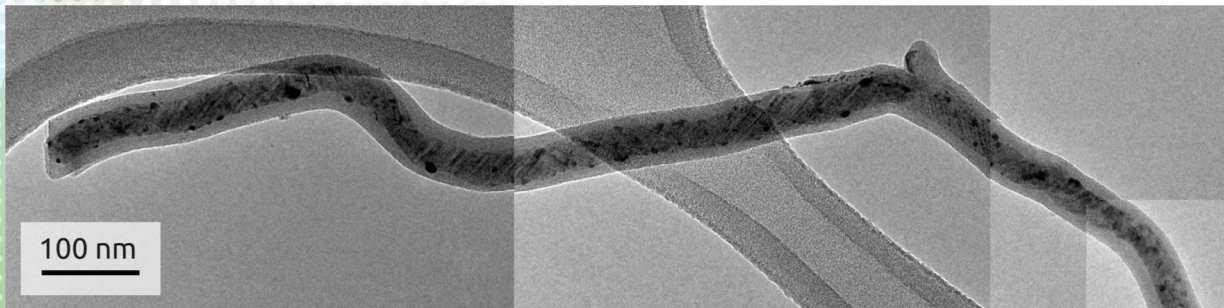

SEM

⇒ Si/SiO<sub>2</sub> nanofilaments filled by Pt/Ti