



HAL
open science

Ga doped ZnO thin films deposited by RF sputtering for NO₂ sensing

L. Presmanes, V. Gunasekaran, Y. Thimont, I. Sinnarasa, A. Barnabé, P. Tailhades, Philippe Menini

► To cite this version:

L. Presmanes, V. Gunasekaran, Y. Thimont, I. Sinnarasa, A. Barnabé, et al.. Ga doped ZnO thin films deposited by RF sputtering for NO₂ sensing. The Experiment@ International Conference (Exp.at'19), Jun 2019, Funchal, Portugal. hal-02172260

HAL Id: hal-02172260

<https://laas.hal.science/hal-02172260v1>

Submitted on 15 Jul 2019

HAL is a multi-disciplinary open access archive for the deposit and dissemination of scientific research documents, whether they are published or not. The documents may come from teaching and research institutions in France or abroad, or from public or private research centers.

L'archive ouverte pluridisciplinaire **HAL**, est destinée au dépôt et à la diffusion de documents scientifiques de niveau recherche, publiés ou non, émanant des établissements d'enseignement et de recherche français ou étrangers, des laboratoires publics ou privés.

Ga doped ZnO thin films deposited by RF sputtering for NO₂ sensing

Lionel Presmanes
CIRIMAT UMR CNRS 5085
Université Paul Sabatier Toulouse 3
Toulouse, France
presmane@chimie.ups-tlse.fr

Inthuga Sinnarasa
CIRIMAT UMR CNRS 5085
Université Paul Sabatier Toulouse 3
Toulouse, France
sinnarasa@chimie.ups-tlse.fr

Vignesh Gunasekaran
CIRIMAT UMR CNRS 5085
Université Paul Sabatier Toulouse 3
Toulouse, France
vignesh.gunasekaran@laas.fr

Antoine Barnabe
CIRIMAT UMR CNRS 5085
Université Paul Sabatier Toulouse 3
Toulouse, France
barnabe@chimie.ups-tlse.fr

Yohann Thimont
CIRIMAT UMR CNRS 5085
Université Paul Sabatier Toulouse 3
Toulouse, France
thimont@chimie.ups-tlse.fr

Philippe Tailhades
CIRIMAT UMR CNRS 5085
Université Paul Sabatier Toulouse 3
Toulouse, France
tailhade@chimie.ups-tlse.fr

Philippe Menini
LAAS CNRS
Toulouse, France
menini@laas.fr

Abstract— Ga doped ZnO thin films have been deposited by Radio-Frequency (RF) magnetron sputtering on fused silica substrates. The structural analysis of the n-type sensitive material showed a preferential orientation in the [001] direction. The microstructure of the thin film indicated an increasing grain size with the increase of the thicknesses. The micro sensor platforms have been fabricated with ZnO:Ga thin film deposited using a reliable stencil mask onto interdigitated electrodes containing micro-hotplates. The as fabricated micro sensor allowed to sense sub-ppm concentration (500 ppb) of nitrogen dioxide under cycled temperature mode. This system revealed promising sensing performance with a response R/R₀ up to 18 at low temperature step (50 °C).

Keywords - ZnO:Ga, thin film, RF-sputtering, gas sensor, micro-hotplate, microsensor, low-cost sensor, NO₂.

I. INTRODUCTION

ZnO is one of the metal oxide which has been studied extensively due to its wide range applications in optoelectronics [1], [2], piezoelectricity [3], catalysis [4], [5] and gas sensing capability [6]–[10]. As well as being a well-known n-type semiconductor with a wide band gap [6], ZnO has the benefit of environment friendly, low-cost, abundant resource and easy preparation. Thanks to these characteristics, ZnO is considered as an ideal gas sensitive material [9], [11] and intensively studied for gas sensor application. In comparison with all the gas sensing studies done in the literature, NO₂ is less sensed by doped ZnO thin films. There are few studies on Sn [12], F [13], Al [14], Y [15], Fe [8] and W [6] doped ZnO for NO₂ sensing properties but none of them investigated the sensing behaviour when the temperature is cycled. Besides, the Ga doped ZnO thin film are almost never studied for NO₂ sensing properties.

ZnO thin films are usually prepared using methods like sol-gel [16], spray pyrolysis [10], sputtering [3], chemical vapor deposition [17], and pulsed laser deposition [18]... The physical deposition, especially the RF sputtering [19] seems more convenient compared to solution processes in order to get high purity thin films. Moreover, by controlling the

deposition parameters, the optimum microstructure with the adapted inter granular porosity can be obtained for better sensing properties.

Therefore, in this work Ga doped ZnO thin films have been deposited by RF magnetron sputtering onto a silicon micro-hotplate and their structural, microstructural and gas sensing properties have been studied.

II. EXPERIMENTAL

A. Thin film deposition

For morphology characterizations, thin films were deposited on fused silica substrate by RF-magnetron sputtering using a ZnO:Ga (4%at.) ceramic target under Argon atmosphere. A 20 min of pre-sputtering under Ar - O₂ mixture was systematically done prior the deposition in order to avoid any target reduction. The deposition conditions are shown in the TABLE 1.

TABLE 1: Deposition parameters of ZnO:Ga thin film by RF-sputtering.

Target material	ZnO:Ga (4 %at)
Power (W)	30
Magnetron	Yes
Argon pressure P (Pa)	2
Target to substrate distance d (cm)	7

B. Thin film characterization

The thickness calibrations were performed with a Dektak 3030ST profilometer and NeoX SENOFAR interferometer. The thickness accuracy of the films has been estimated at +/- 3%. The phase of the as deposited thin film was checked using X-Ray Diffraction (XRD) using a D4-Endeavor Bruker diffractometer equipped with a copper anode and LynxEye 2D detector. The microstructure of the films was observed using a Nanoscope III Dimension 3000 Atomic Force Microscope (AFM). AFM surface views were analysed using the Gwyddion software.

C. Thin film integration process via stencil mask

To be able to sense NO_2 gas, micro-hotplates were developed using photolithographic process. It is basically a system composed by a heating element and sensing electrodes. They are both integrated in membrane in order to have a localized heating and sensing spot onto which the sensitive thin film will be deposited. They can operate with low consumption and can heat up to 500°C with a good stability. This system was already published in [19].

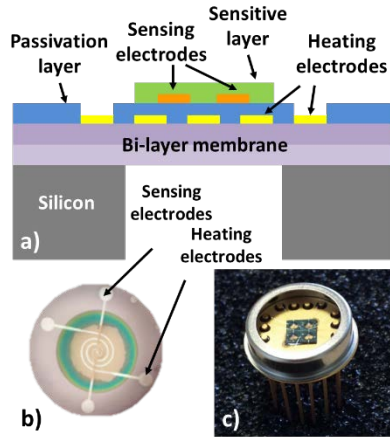

FIGURE 1: a) Schematic representation of the system, b) optical micrograph of the electrodes and c) picture of the micro-sensor.

The FIGURE 1a shows the schematic representation of the system composed by a heating electrodes and sensing electrodes (165 nm thick) separated by a passivation layer onto which the sensitive layer is deposited.

In micro-fabrication, the localized deposition is commonly done by a photolithography and a lift-off process. The main disadvantage of the process is the use of photoresist and its remover. Indeed the involvement of this solution can lead the sensitive layer's dissolution and/or contamination. For these reasons, the photolithographic method was avoided and a stencil mask process was used.

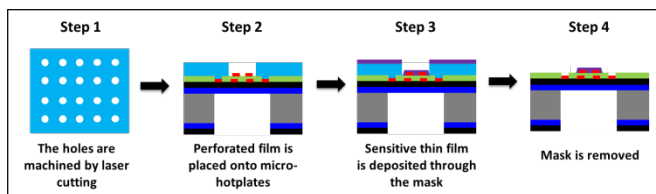

FIGURE 2: Integration process of ZnO:Ga using stencil mask.

The main steps of the integration process of ZnO:Ga thin film are described in the FIGURE 2. The shadow mask is a $96\ \mu\text{m}$ thick PET film with in one side a thermosensitive adhesive. Holes ($800\ \mu\text{m}$ radius) were cut by a laser engraver (step 1) to fully cover the interdigitated electrodes but to remain smaller than the whole membrane. Then, the mask was aligned to have the membrane facing holes by using an optical microscope and a pick-and-place machine (step 2). After 90 nm deposition (step 3), the adhesive mask was peeled off (step 4), leaving a localized deposition in the sensing area on the membrane.

The wafers were then cleaved in order to get a group of 4 sensors and were bond in a 16 pin TO5 devices so they can fit to the test bench. No annealing treatment of the wafer has been carried out after deposition of ZnO:Ga layer, however each

sensor has been initialized at the first stage of the measurement phase by operating the microheater at 350°C for 2h.

D. Experiment protocol

The test bench is composed by 200 ml gas chamber in which different gases with different concentrations can flow. The micro-sensor was put into the chamber and linked to a SMU in a computer where the whole test bench is managed by a LabVIEW program. The total gas flow during the sensing measurement is fixed at 200 ml/min .

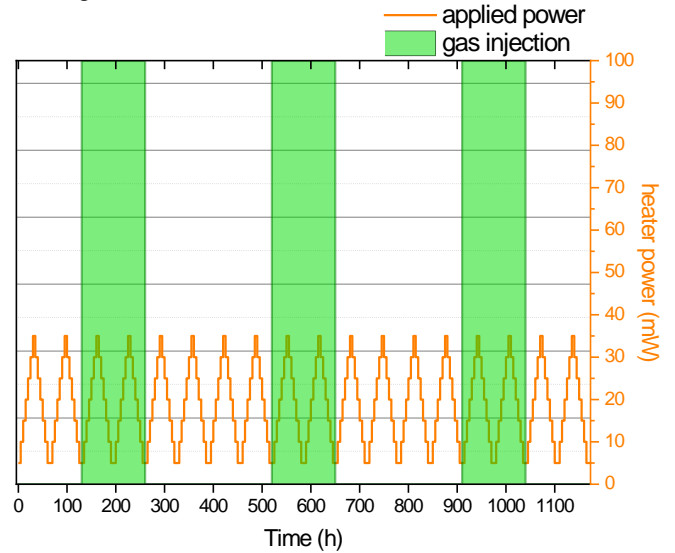

FIGURE 3: Test protocol for the micro-sensors.

The FIGURE 3 shows the test protocol used in the test bench. It is a cycle of heating and cooling (presented in orange) from 5 mW to 35 mW with a step of 5 mW for 5 min which correspond approximately to 50°C to 350°C . In green, the presence of the target gas (NO_2 at 500 ppb). The tests were performed with 50% relative humidity. Prior to each measurement experiment the micro-sensor was heated 2 hours under air with 50% humidity at 35 mW ($\sim 350^\circ\text{C}$).

III. RESULTS AND DISCUSSION

A. Structural analysis of ZnO:Ga thin film

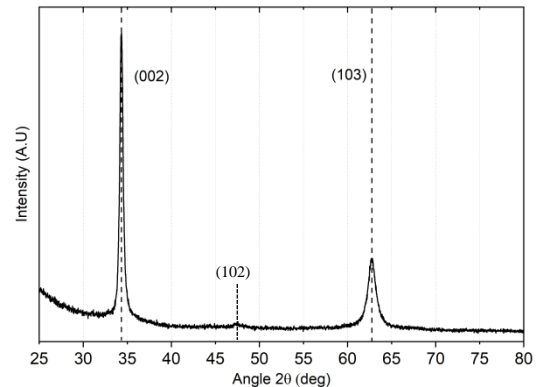

FIGURE 4: XRD pattern of 50 nm thick ZnO:Ga thin film.

The XRD pattern of the as-deposited 90 nm thick ZnO:Ga thin films is shown in the FIGURE 4. The presence of peaks related to (002) planes confirms that the ZnO was crystallized with a high c -axis orientation perpendicular to the substrate. There were no additional phases detected so it confirmed that

the experimental conditions used to elaborate the thin film provided a pure ZnO:Ga phase. The lattice parameters $a = 3.46(1) \text{ \AA}$ and $c = 5.07(0) \text{ \AA}$ were calculated from Rietveld refinement using Fullprof software and are in good agreement with the ZnO:Ga parameters reported in literature [20].

B. Morphology and surface state

The observation of the surface was done by Atomic Force Microscopy (AFM) on 25, 50, 100 and 200 nm thick films deposited on fused silica substrate, and reported in FIGURE 5. The obtained micrographs show well-defined grains for whole thicknesses. The evolution of the grain size is shown in FIGURE 6. As proved by previous studies [14] it is clear that during the deposition, ZnO grows on the substrate forming columns and its grain size increases with increasing film thickness.

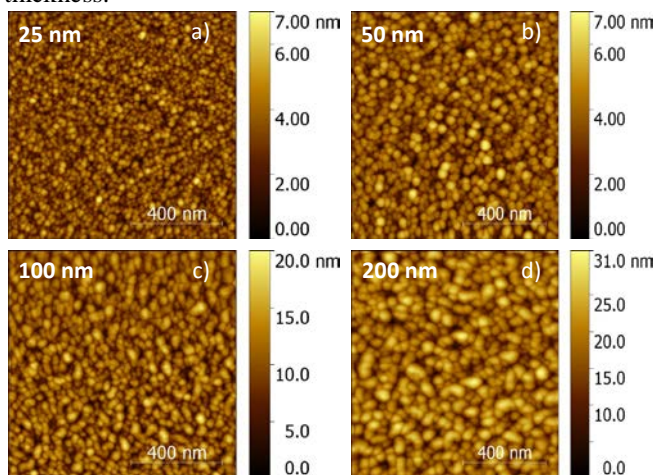

FIGURE 5: AFM micrographs of a) 25 nm, b) 50 nm, c) 100 nm and d) 200 nm thick ZnO:Ga thin films.

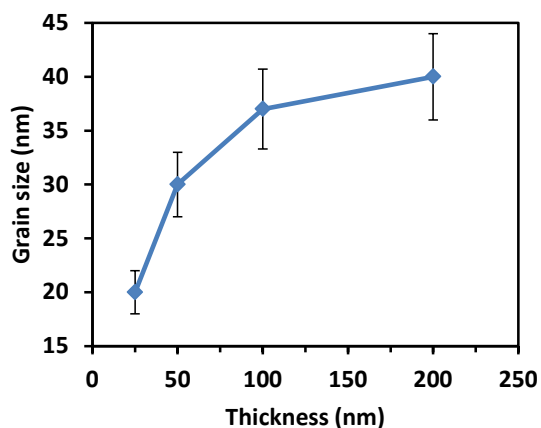

FIGURE 6: Evolution of the grain size as a function of the film thickness.

C. Sensing results

For this preliminary study, the sensing measurements have been arbitrary carried out on 50 nm thick film.

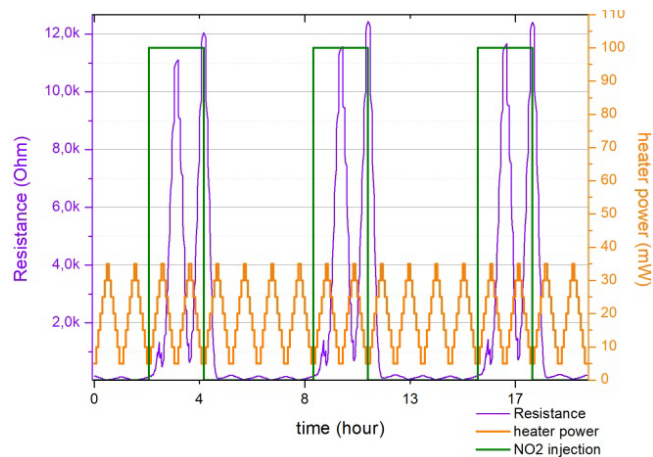

FIGURE 7: Evolution of the resistance of 50 nm thick ZnO:Ga layer under air and air + 500 ppb of NO_2 (with 50% relative humidity).

The FIGURE 7 shows the behavior of the resistance, in the presence/absence of NO_2 at different heater power (temperature). In presence of air, the resistance is very low due the high conductivity of doped zinc oxide (near 300Ω) but increases up to 7 k Ω when the gas is injected and the influence of the temperature is clearly visible.

For further studies, only the last heating cycle under the last NO_2 injection will be considered it will be compared with the last heating cycle under air before the last NO_2 injection.

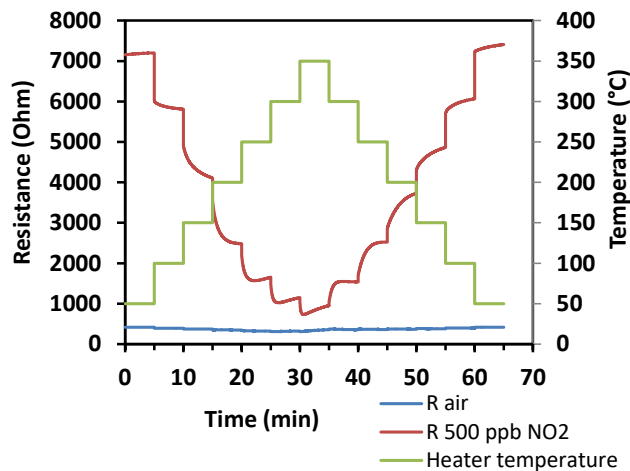

FIGURE 8: Resistance variation under Air (in black) and under NO_2 (in red).

The FIGURE 8 shows the overlay of resistance under air and under NO_2 . The temperature influence can be seen by the step behaviour of the resistance. The resistance decreases when the temperature increases. To estimate the response of the material for NO_2 sensing, the ratio R/R_0 (where R is the resistance under NO_2 and R_0 the resistance under air) has been calculated using the last points at each temperature step and presented in the FIGURE 9.

A slight difference can be seen in the response when the temperature is increased or decreased. Moreover, the response is much higher at low temperature.

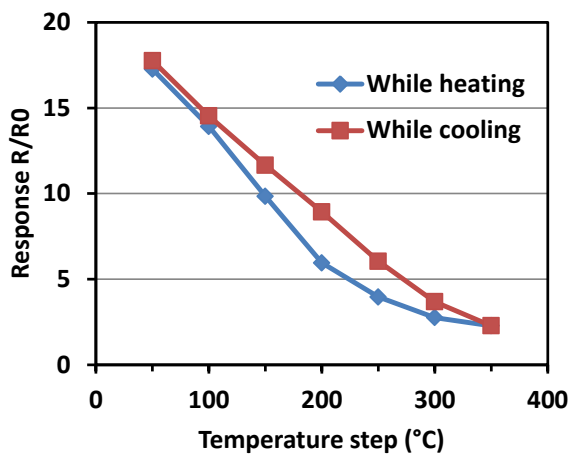

FIGURE 9: Response of ZnO:Ga as a function of the temperature step (step duration is 5 minutes).

The present results cannot be compared with other authors, because to our knowledge there are no paper showing studies on ZnO:Ga as NO₂ sensing material in temperature cycled mode. A response up to 18 for 500 ppb of NO₂ at 50 °C (R/R0 ~ 36 / ppm) positions our system among the more promising ones [11]. However few papers show that equivalent or better results have been obtained operating in isothermal mode with nanoparticles of ZnO:Ga activated by H₂ (R/R0 ~ 50 / ppm) [21], sputtered ZnO:W thin films (R/R0 ~ 35 / ppm) [6], ZnO:Fe microflowers (R/R0 ~ 60 / ppm) [8], ZnO/(Au-Pd) nanowires (R/R0 ~ 94 / ppm) [22]. Due to the low background resistance under air, the electrode design should be optimized for the detection of reducing gases which lead to a decrease of the resistance. The selectivity of ZnO:Ga has not been evaluated in this work. At this early stage, the reproducibility and repeatability of this sensor have not been yet evaluated.

IV. CONCLUSIONS

Ga doped ZnO thin films were deposited on fused silica substrates using RF sputtering. The XRD analysis showed a visible orientation in the [001] direction. The microstructure of the thin film indicated an increasing grain size with an increasing thickness.

Then 50 nm thick ZnO:Ga thin film was deposited onto a silicon based micro-hotplates without any photolithography process thanks to a low cost and reliable stencil mask process. A localized deposition has been obtained just on the interdigitated electrodes spots. Thanks to this process, sub-ppm sensing (500 ppb) of NO₂ gas at low temperature (50 °C) has been performed and showed promising responses R/R0 up to 18.

REFERENCES

- [1] X. B. Wang, C. Song, K. W. Geng, F. Zeng, and F. Pan, "Photoluminescence and Raman scattering of Cu-doped ZnO films prepared by magnetron sputtering", *Appl. Surf. Sci.*, vol. 253, pp. 6905–6909, June 2007.
- [2] M. A. Martínez, J. Herrero, and M. T. Gutiérrez, "Deposition of transparent and conductive Al-doped ZnO thin films for photovoltaic solar cells", *Sol. Energy Mater. Sol. Cells*, vol. 45, pp. 75–86, January 1997.
- [3] J. Chen, Y. Gao, F. Zeng, D. Li, and F. Pan, "Effect of sputtering oxygen partial pressures on structure and physical properties of high resistivity ZnO films", *Appl. Surf. Sci.*, vol. 223, pp. 318–329, February 2004.
- [4] Y. Wang, J. Zhang, H. Xu, and X. Bai, "Reduction of Pd/ZnO Catalyst and Its Catalytic Activity for Steam Reforming of Methanol", *Chinese J. Catal.*, vol. 28, pp. 234–238, March 2007.
- [5] Y. Sun, L. Chen, Y. Bao, Y. Zhang, J. Wang, M. Fu, J. Wu, and D. Ye, "The Applications of Morphology Controlled ZnO in Catalysis", *Catalysts*, vol. 6, #188, November 2016.
- [6] T. Tesfamichael, C. Cetin, C. Piloto, M. Arita, and J. Bell, "The effect of pressure and W-doping on the properties of ZnO thin films for NO₂ gas sensing", *Appl. Surf. Sci.*, vol. 357, pp. 728–734, December 2015.
- [7] R. Dhahri, M. Hjiri, L.El. Mir, A. Bonavita, D. Iannazzo, S.G. Leonardi, and G. Neri, "CO sensing properties under UV radiation of Ga-doped ZnO nanopowders", *Appl. Surf. Sci.*, vol. 355, pp. 1321–1326, November 2015.
- [8] S. Bai, T. Guo, Y. Zhao, J. Sun, D. Li, A. Chen, and C. C. Liu, "Sensing performance and mechanism of Fe-doped ZnO microflowers", *Sensors Actuators B Chem.*, vol. 195, pp. 657–666, May 2014.
- [9] L. Zhu and W. Zeng, "Room-temperature gas sensing of ZnO-based gas sensor: A review", *Sensors Actuators A Phys.*, vol. 267, pp. 242–261, November 2017.
- [10] G. K. Mani and J. B. B. Rayappan, "A highly selective room temperature ammonia sensor using spray deposited zinc oxide thin film", *Sensors Actuators B Chem.*, vol. 183, pp. 459–466, July 2013.
- [11] R. Kumar, O. Al-Dossary, G. Kumar, and A. Umar, "Zinc Oxide Nanostructures for NO₂ Gas-Sensor Applications: A Review", *Nano-Micro Lett.*, vol. 7, pp. 97–120, April 2015.
- [12] S. T. Shishiyanu, T. S. Shishiyanu, and O. I. Lupan, "Sensing characteristics of tin-doped ZnO thin films as NO₂ gas sensor", *Sensors Actuators B Chem.*, vol. 107, pp. 379–386, May 2005.
- [13] E. Şennik, S. Kerli, Ü. Alver, and Z. Z. Öztürk, "Effect of fluorine doping on the NO₂-sensing properties of ZnO thin films", *Sensors Actuators B Chem.*, vol. 216, pp. 49–56, September 2015.
- [14] A. R. Nimbalkar, N. B. Patil, V. V. Ganbavle, S. V. Mohite, K. V. Madhale, and M. G. Patil, "Sol-gel derived aluminium doped zinc oxide thin films: A view of aluminium doping effect on physicochemical and NO₂ sensing properties", *J. Alloys Compd.*, vol. 775, pp. 466–473, February 2019.
- [15] N. Kılınc, S. Öztürk, L. Arda, A. Altındal, and Z. Z. Öztürk, "Structural, electrical transport and NO₂ sensing properties of Y-doped ZnO thin films", *J. Alloys Compd.*, vol. 536, pp. 138–144, September 2012.
- [16] M. Vanaraja, K. Muthukrishnan, S. Boomadevi, R. Kumar Karn, V. Singh, P. K. Singh, and K. Pandiyan, "Dip coated nanostructured ZnO thin film: Synthesis and application", *Ceram. Int.*, vol. 42, pp. 4413–4420, February 2016.
- [17] G. Valverde Aguilar, M. R. Jaime Fonseca, A. Mantilla Ramírez, and A. G. Juárez Gracia, "Photoluminescence Studies on ZnO Thin Films Obtained by Sol-Gel Method", in *Recent Applications in Sol-Gel Synthesis*, U. Chandra, IntechOpen, 2017.
- [18] Y. Y. Villanueva, D. R. Liu, and P. T. Cheng, "Pulsed laser deposition of zinc oxide", *Thin Solid Films*, vol. 501, pp. 366–369, April 2006.
- [19] L. Presmanes, Y. Thimont, I. El Younsi, A. Chappelle, F. Blanc, C. Talhi, C. Bonningue, A. Barnabé, Ph. Menini, and Ph. Tailhades, "Integration of P-CuO Thin Sputtered Layers onto Microsensor Platforms for Gas Sensing", *Sensors*, vol. 17, #1409, June 2017.
- [20] N.R. Aghamalyan, E.A. Kafadaryan, R.K. Hovsepyan, S.I. Petrosyan, "Absorption and reflection analysis of transparent conductive Ga-doped ZnO films", *Semicond. Sci. Technol.*, vol. 20, pp. 80–85, December 2004.
- [21] Z. Wang, Z. Xie, L. Bian, W. Li, X. Zhou, X. Wu, Z. Yang, N. Han, J. Zhang, and Y. Chen, "Enhanced NO₂ Sensing Property of ZnO by Ga Doping and H₂ Activation", *Physica Status Solidi a*, vol. 215, #1700861, June 2018.
- [22] X. Chen, Y. Shen, P. Zhou, X. Zhong, G. Li, C. Han, D. Wei, and S. Li, "Bimetallic Au/Pd nanoparticles decorated ZnO nanowires for NO₂ detection", *Sensors Actuators B Chem.*, vol. 289, pp. 160–168, June 2019.