



ADCSS 2020

22/10/2020



Anomaly Detection for Radiation Hardening of Space Electronics

-

Application of Machine Learning Algorithms on an Atmel SAM3X Microcontroller

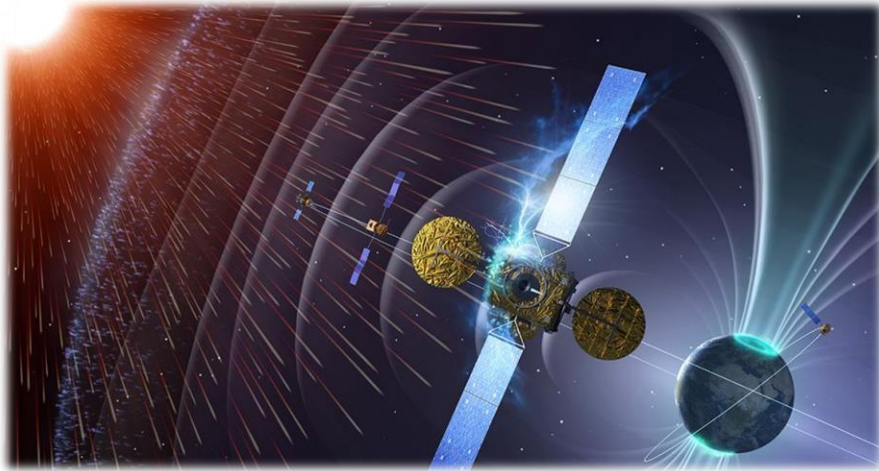

PhD student : Adrien Dorise
Thesis supervisors : Louise Travé-Massuyès
Corinne Alonso
Audine Subias
François Vacher
Leny Baczkowsky

Co-financing CNES – région Occitanie

Space radiations

- > Satellites in orbit subject to space radiation.
 - LEO : Low Earth Orbit (1 000 km above Earth).
 - GEO : Geostationary Earth Orbit (42 000 km above Earth).

- > 3 types of radiation
 - Solar flares
 - Cosmic rays
 - Radiation belts

Solar flares

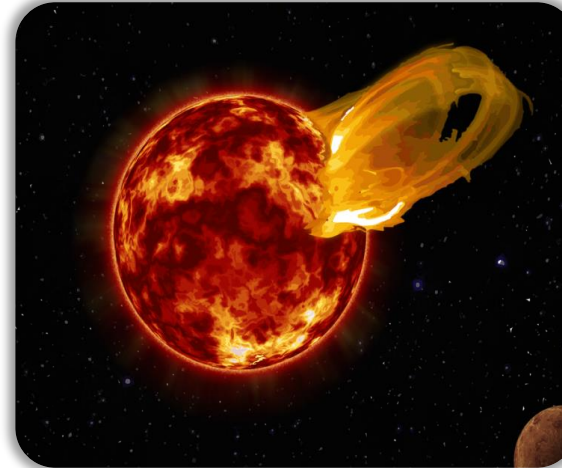

Cosmic rays

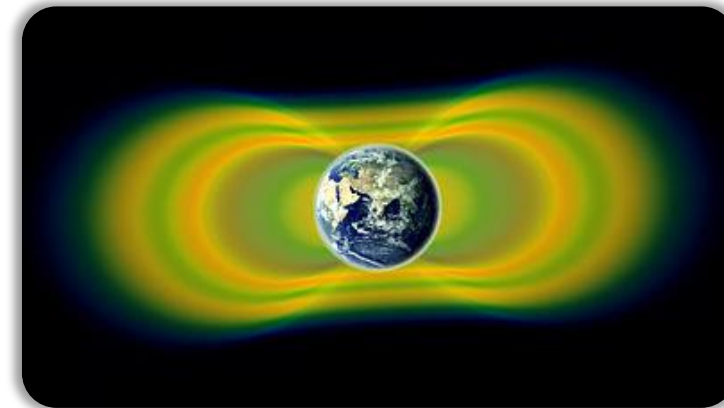

Van Allen radiation belts

Context

- Space radiation
- SEE
- Monitoring

Thesis problematic

SAM3X8E microcontroller

Data set Creation

- Laser testing
- Simulation

Anomaly detection toolbox

- Data Set presentation
- Classification

Work in progress

- > SEEs in a micro-electronic device are caused by a single energetic particle and can take many forms.
 - Single Event Upset (SEU) is a logical change of state by one ionizing particle striking a sensitive node.
 - **Single Event Latch up (SEL):** Consumption current modification due to the creation of a low-impedence path triggering a parasitic structure, possibly leading to the destruction of the component. A power cycle is required to correct the situation.

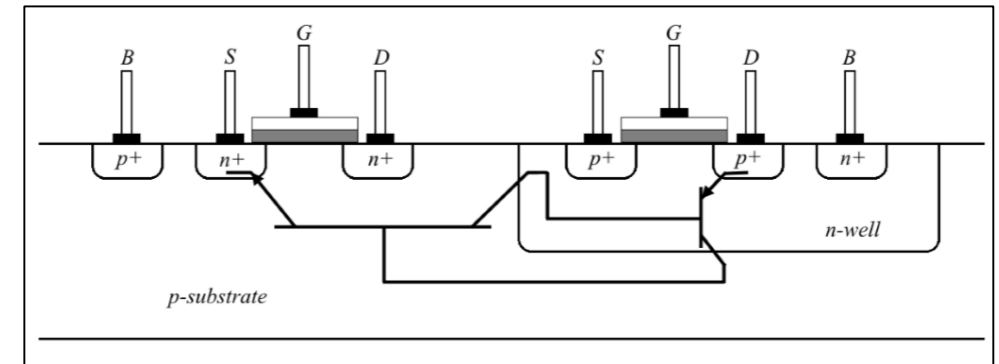
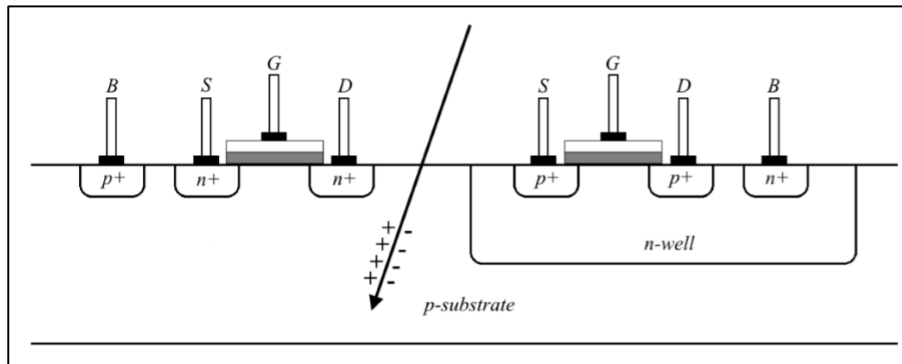

Ionizing particle hitting the semi-conductor

Context

- Space radiation
- SEE
- Monitoring

Thesis problematic

SAM3X8E microcontroller

Data set Creation

- Laser testing
- Simulation

Anomaly detection toolbox

- Data Set presentation
- Classification

Work in progress

- > **μLatch-up**: Non destructive latch up
 - Consequence => High Current Event (HCE)
 - Can be hard to detect because lost in the original signal.
 - Persistent without a power reset.

Context

- Space radiation
- SEE
- Monitoring

Thesis problematic

SAM3X8E microcontroller

Data set Creation

- Laser testing
- Simulation

Anomaly detection toolbox

- Data Set presentation
- Classification

Work in progress

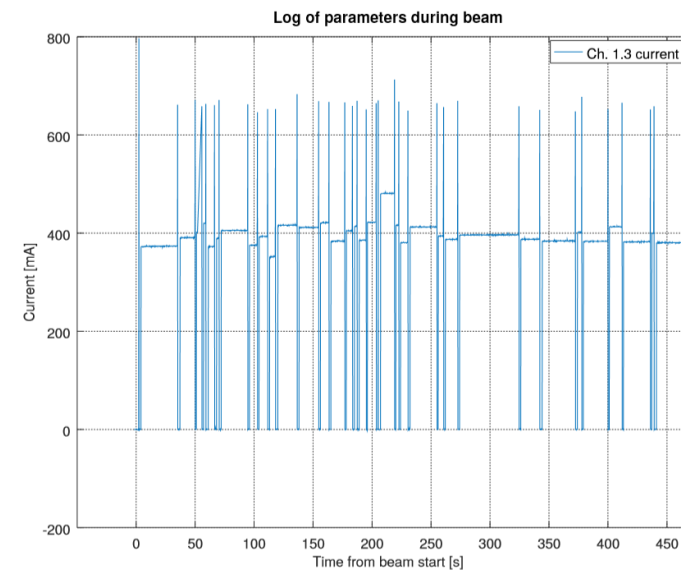
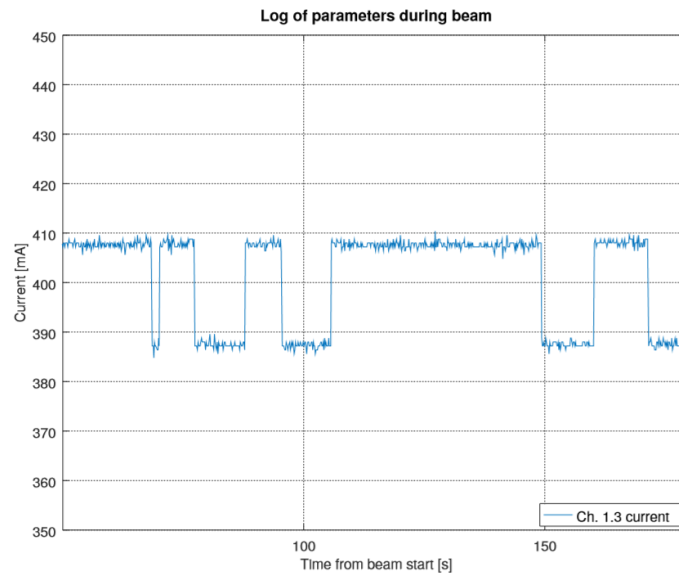

Radiation testings on Raspberry pi 3

Context

- Space radiation
- SEE
- Monitoring

Thesis problematic

SAM3X8E microcontroller

Data set Creation

- Laser testing
- Simulation

Anomaly detection toolbox

- Data Set presentation
- Classification

Work in progress

- > Actual solutions:
- Shielding (protect against radiation dose)
 - Hardening
 - Anti latch-up system
- Expensive

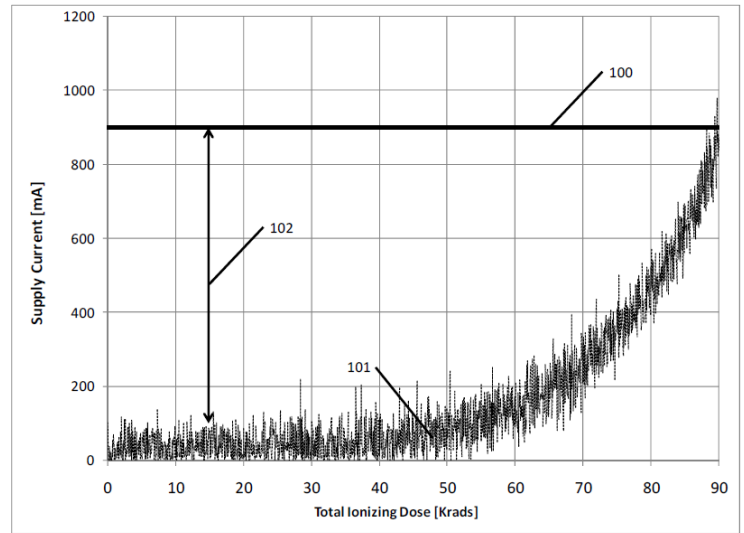

Anti latch-up system example

Impossible to detect μ Latch-up

Thesis problematic

- > Actual threshold protection circuit
 - Which threshold level?
 - SEL can also decrease the consumption current (standby state).
 - Low HCE are undetectable but can still damage the component.



- > Thesis: Artificial Intelligence applied to embedded protection circuit design
 - Uses of AI for anomaly detection
 - Learning of the consumption current behaviors.
 - Software solution

Context

- Space radiation
- SEE
- Monitoring

Thesis problematic

SAM3X8E microcontroller

Data set Creation

- Laser testing
- Simulation

Anomaly detection toolbox

- Data Set presentation
- Classification

Work in progress

Thesis problematic

Context

- Space radiation
- SEE
- Monitoring

Thesis problematic

SAM3X8E microcontroller

Data set Creation

- Laser testing
- Simulation

Anomaly detection toolbox

- Data Set presentation
- Classification

Work in progress

Methodology

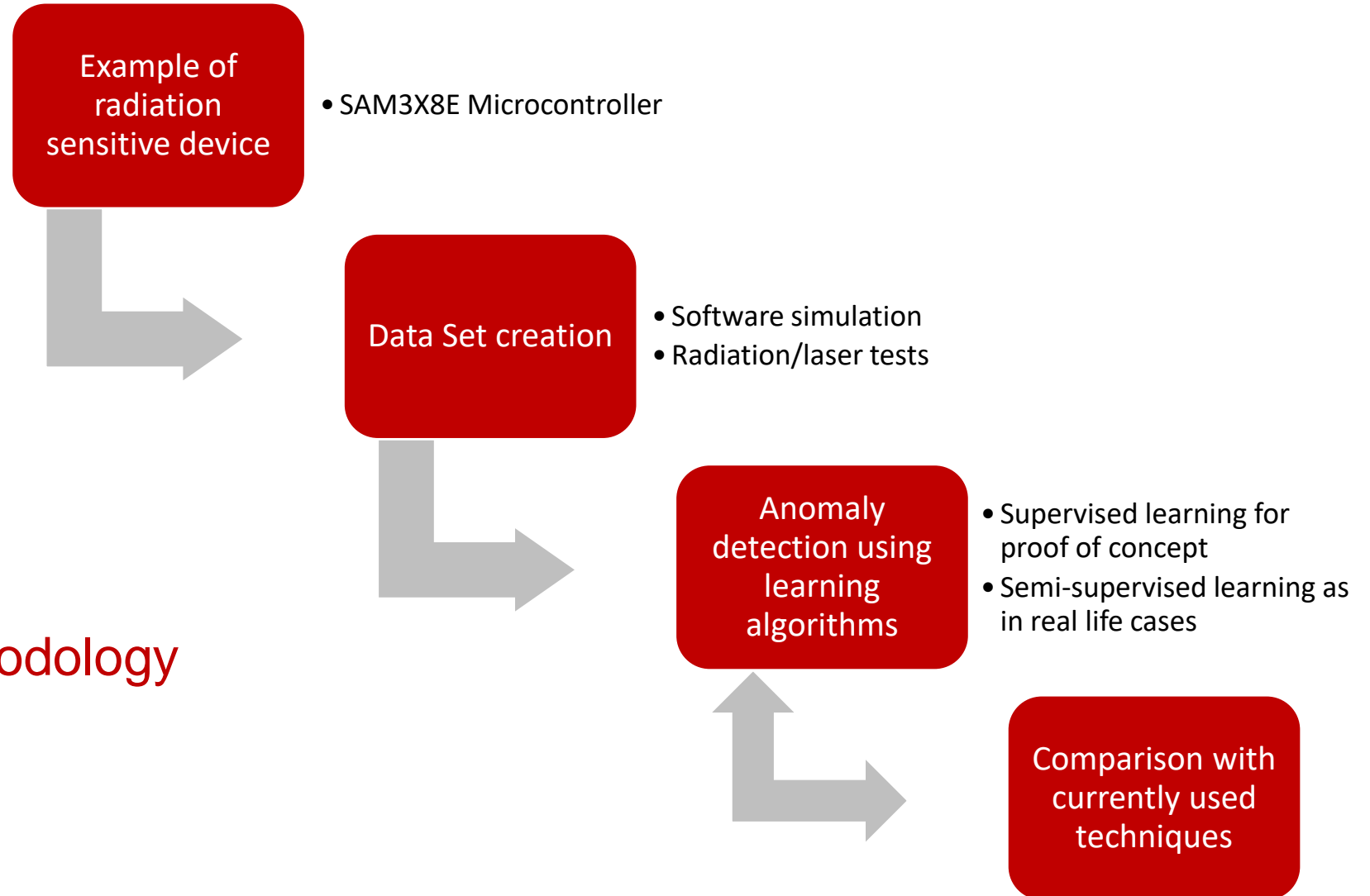

SAM3X8E microcontroller

> Arduino Due board equipped with a SAM3X8E microcontroller used for tests

- Fault emulator created
- Study of the impact of converters on the consumption current

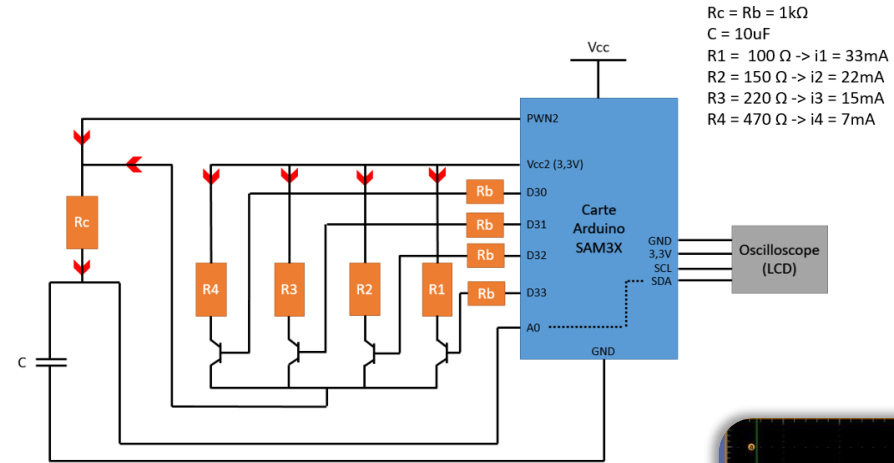

Fault emulator

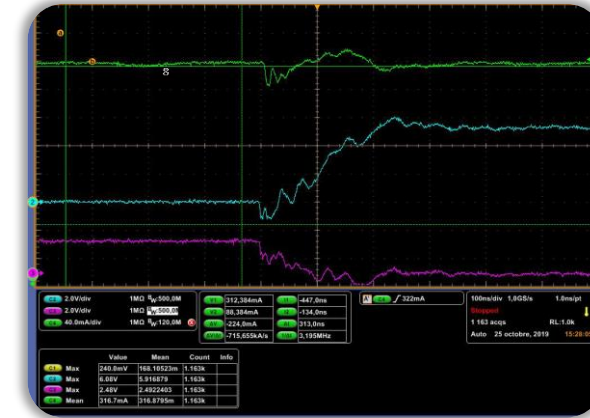
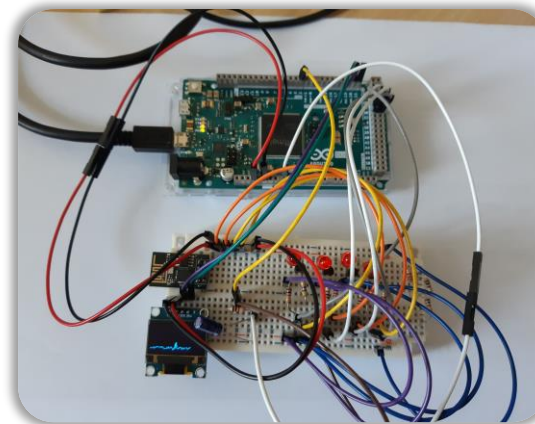

Boost converter

Context

- Space radiation
- SEE
- Monitoring

Thesis problematic

SAM3X8E microcontroller

Data set Creation

- Laser testing
- Simulation

Anomaly detection toolbox

- Data Set presentation
- Classification

Work in progress

SAM3X8E microcontroller

- > 2 major consumption profiles
 - Functions significantly impact consumption current of the SAM3X8E microcontroller

Context

- Space radiation
- SEE
- Monitoring

Thesis problematic

SAM3X8E microcontroller

Data set Creation

- Laser testing
- Simulation

Anomaly detection toolbox

- Data Set presentation
- Classification

Work in progress

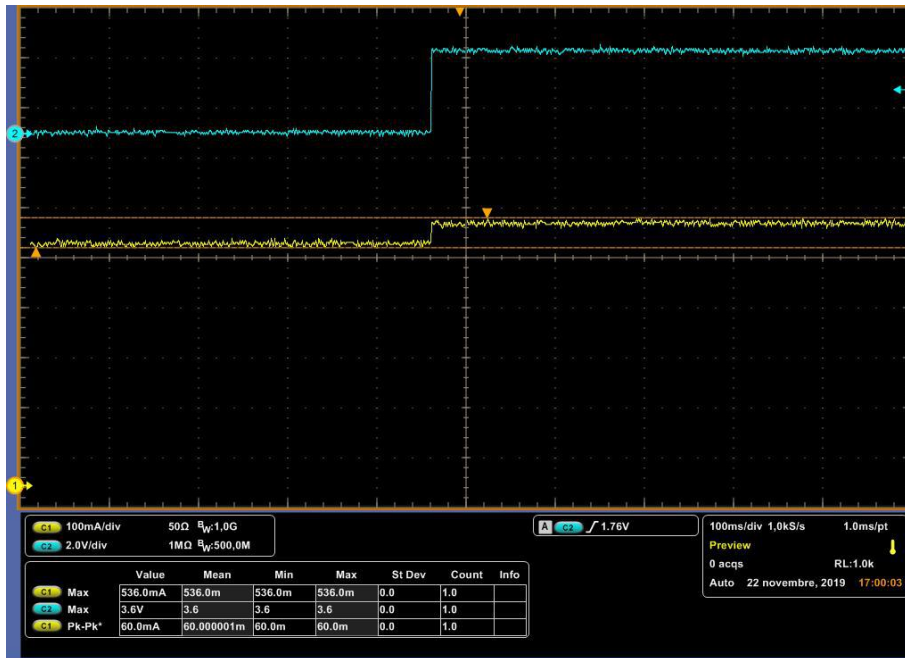

I/O consumption

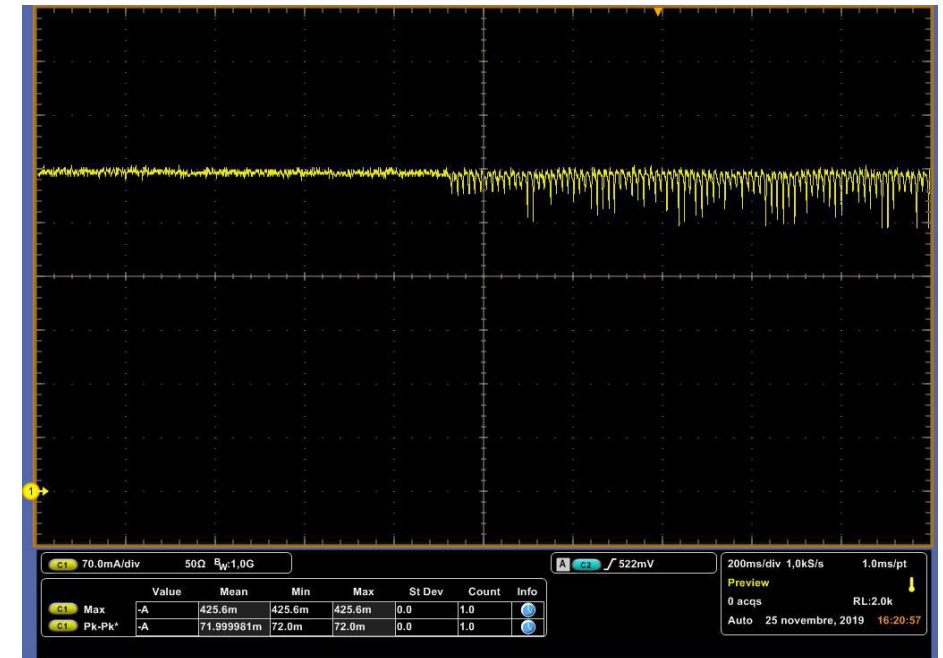

Software consumption

Data Set creation

Laser testing

- Context
- Space radiation
 - SEE
 - Monitoring
- Thesis problematic
- SAM3X8E microcontroller
- Data set Creation
- Laser testing
 - Simulation
- Anomaly detection toolbox
- Data Set presentation
 - Classification
- Work in progress

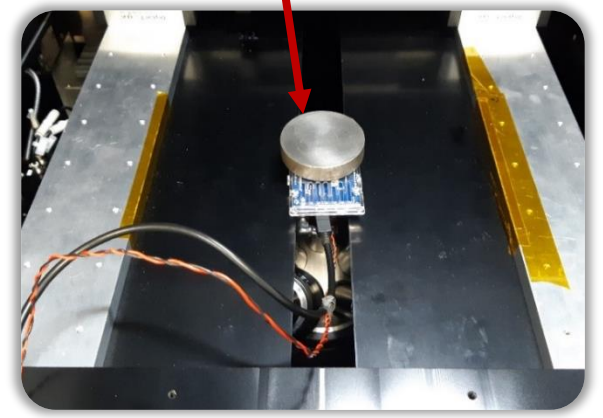
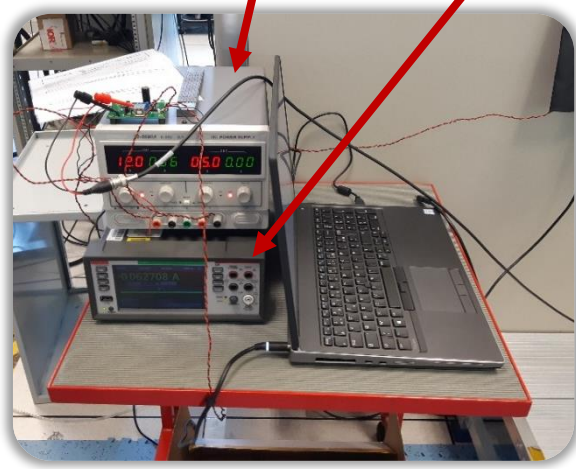
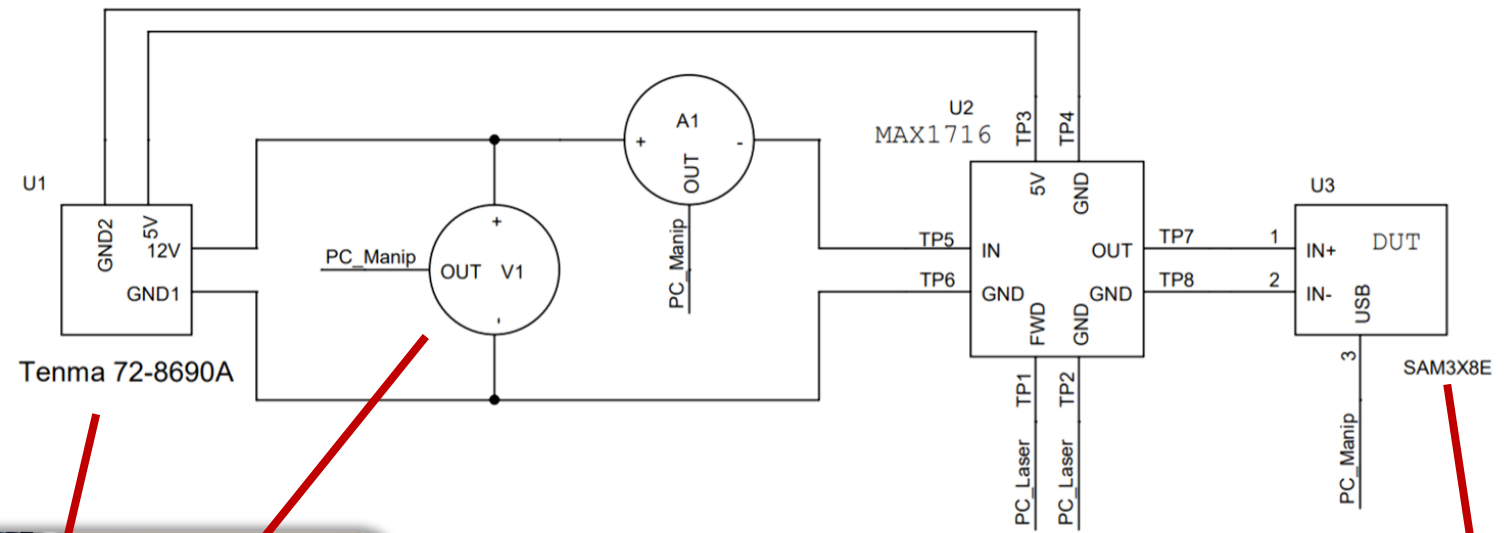

Laser bench, CNES Toulouse

Data Set creation

Laser testing

- Context
- Space radiation
 - SEE
 - Monitoring
- Thesis problematic
- SAM3X8E microcontroller
- Data set Creation
- Laser testing
 - Simulation
- Anomaly detection toolbox
- Data Set presentation
 - Classification
- Work in progress

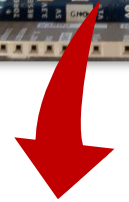
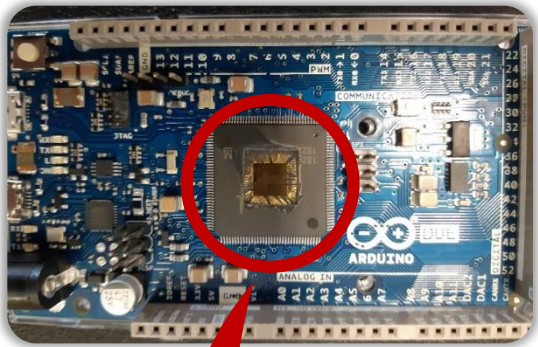

- > We found 2 types of faults during the laser testing
 - Current faults
 - Latch-up

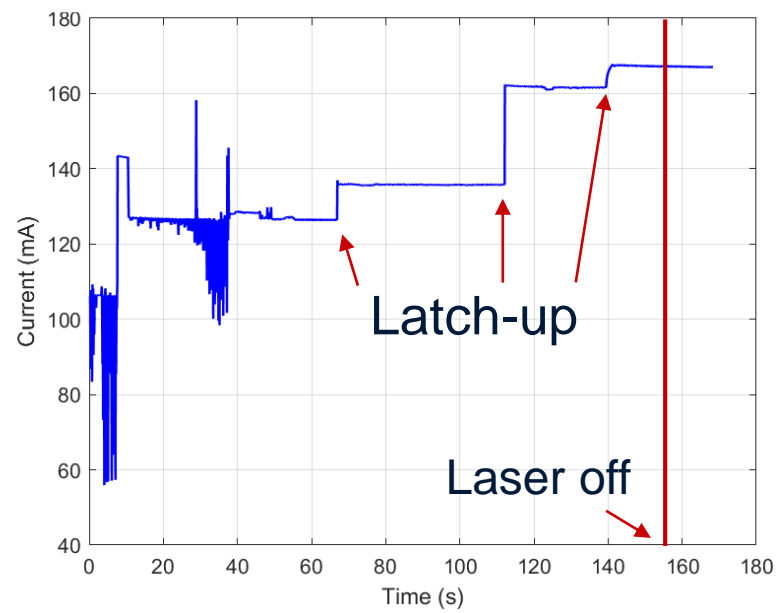
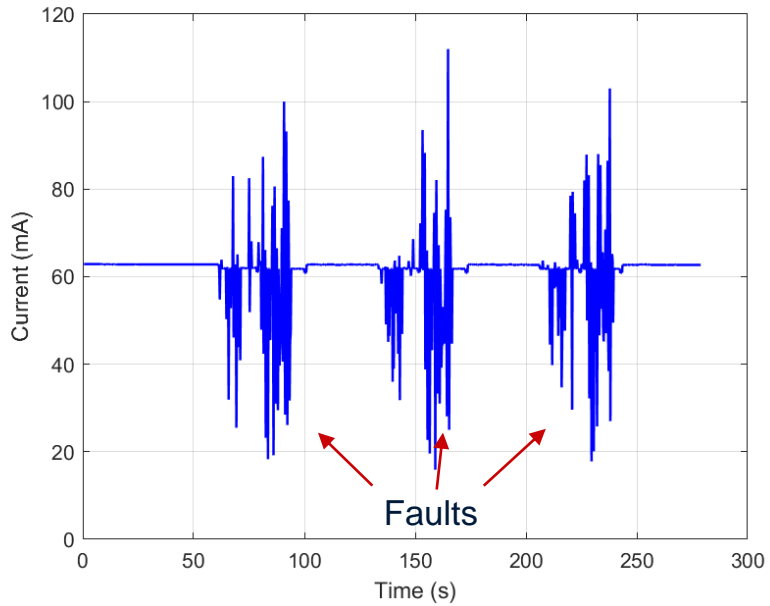

Data Set creation

Simulation

- > Matlab data generator
 - Generates random data sets
 - Multiple configurations possible

- > Not a model based generator
 - Not representative of reality
 - **Mainly used to test statistical features**

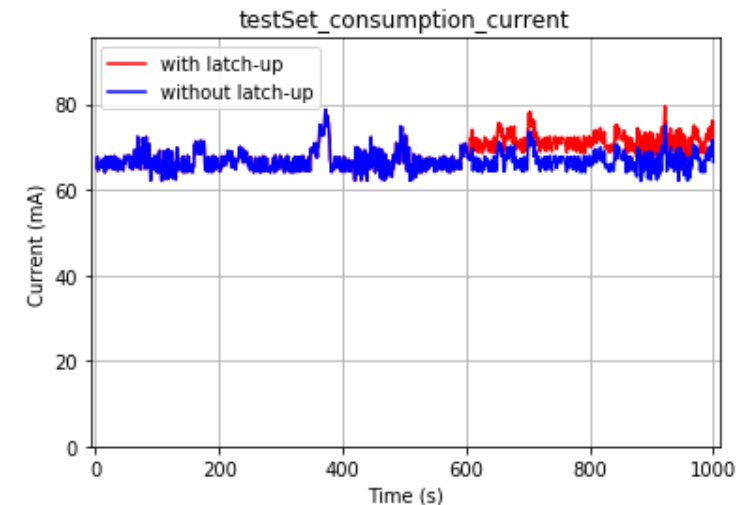
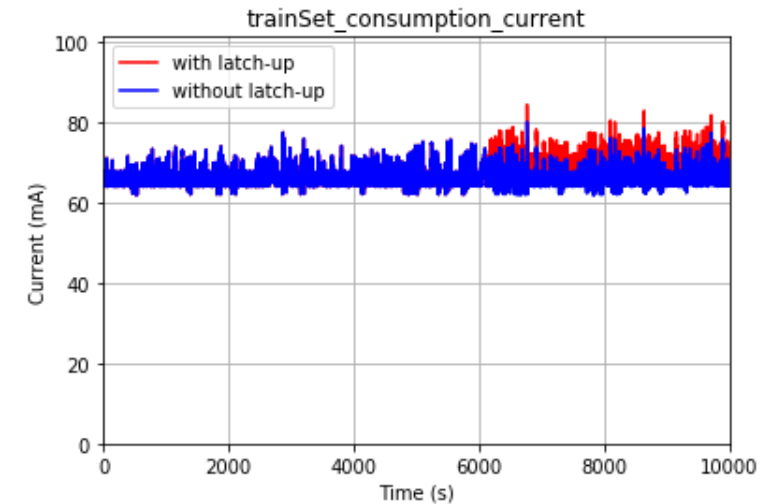

Context

- Space radiation
- SEE
- Monitoring

Thesis problematic

SAM3X8E microcontroller

Data set Creation

- Laser testing
- Simulation

Anomaly detection toolbox

- Data Set presentation
- Classification

Work in progress

Anomaly Detection Toolbox

Data Set presentation

- > 4 example data sets
 - Simulated and real data sets
 - Training and test sets

Context

- Space radiation
- SEE
- Monitoring

Thesis problematic

SAM3X8E microcontroller

Data set Creation

- Laser testing
- Simulation

Anomaly detection toolbox

- Data Set presentation
- Classification

Work in progress

- Clustering
- Electronic board

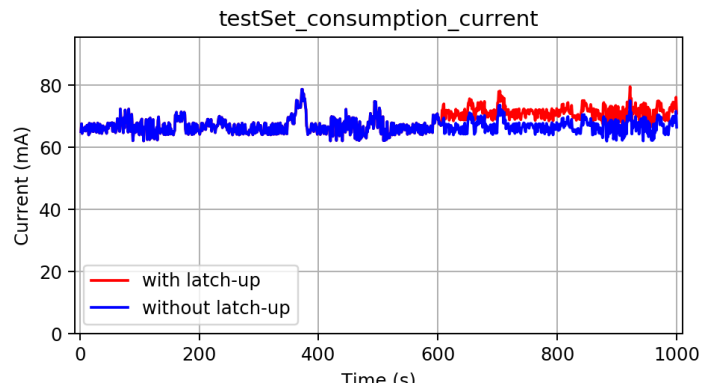
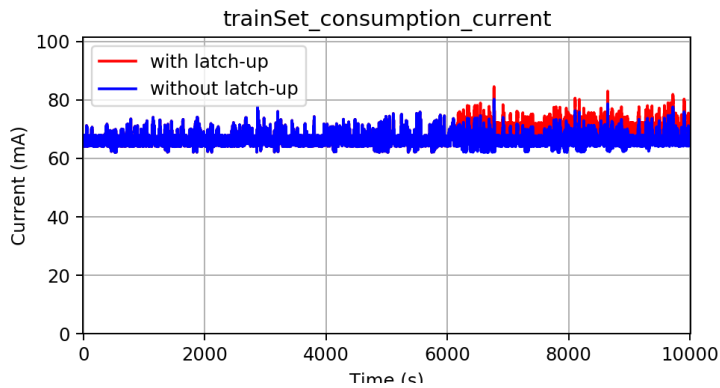

Simulated

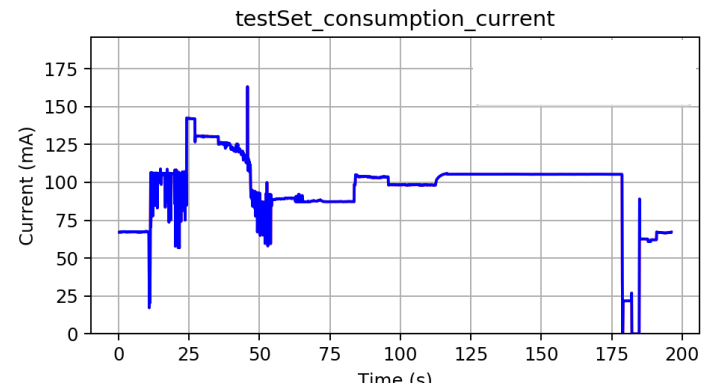
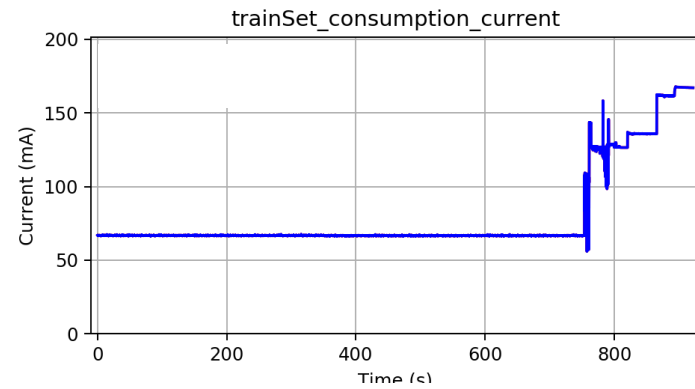

Real

Anomaly Detection Toolbox

Data Set presentation

> Working on both data sets for comparison (simulated & real)

> Real data set

- Example of a real latch-up
- 1s sampling time

> Simulated data set

- Example of μ Latch-up
- 1s sampling time

Features of simulated data set

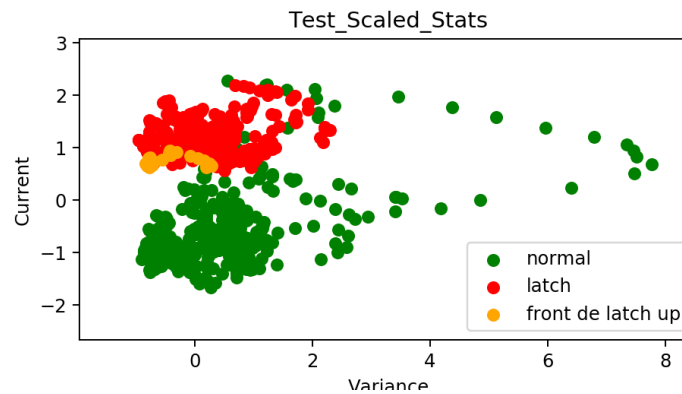
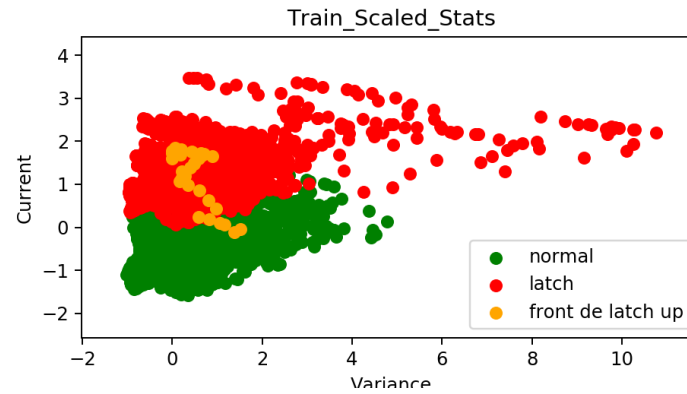

Features of real data set

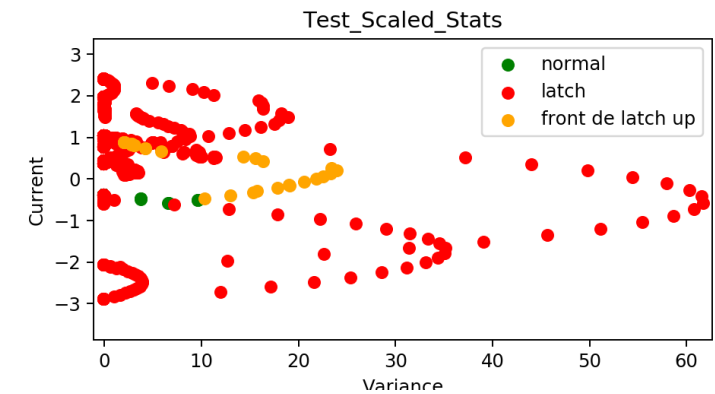
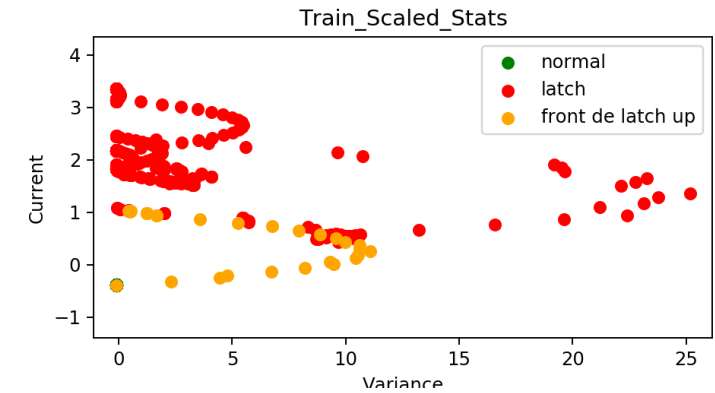

Context

- Space radiation
- SEE
- Monitoring

Thesis problematic

SAM3X8E microcontroller

Data set Creation

- Laser testing
- Simulation

Anomaly detection toolbox

- Data Set presentation
- Classification

Work in progress

> Classification

- 5 implemented algorithms
- Up to 3 classes
 - normal current
 - latch-up current
 - transitory phase

Training on simulated data set

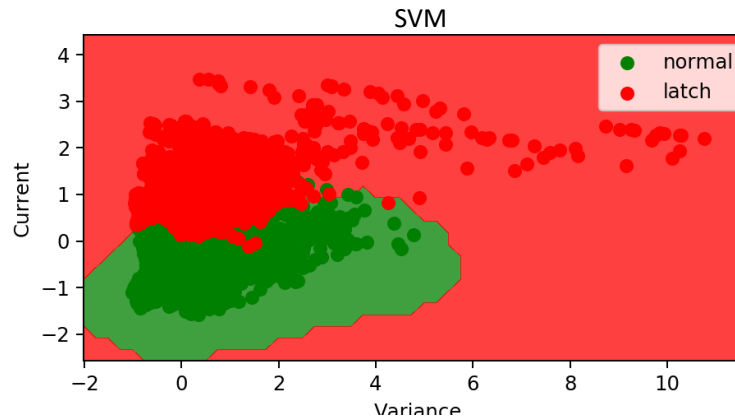

Training on real data set

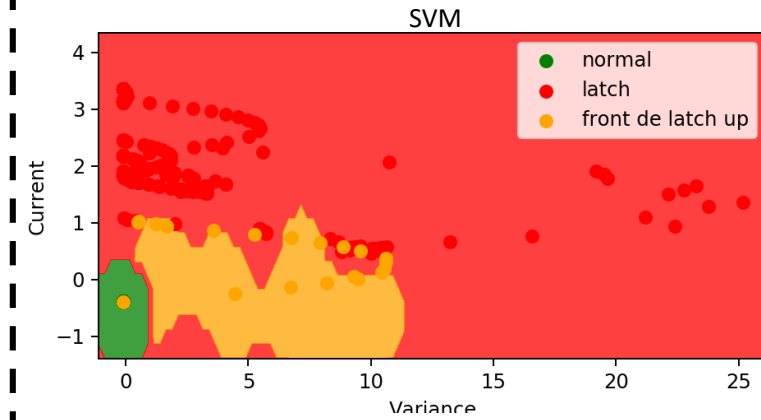

Results on simulated data set

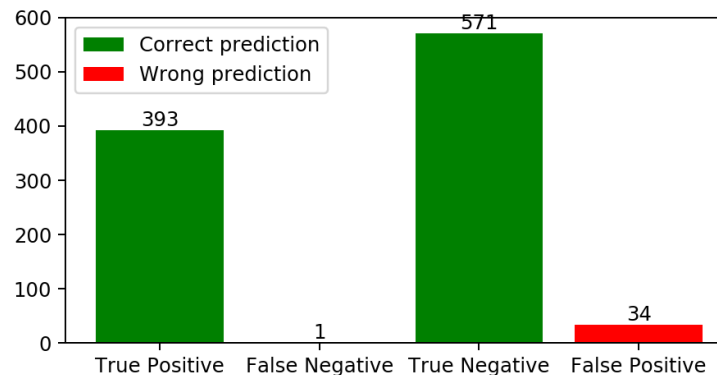

Results on real data set

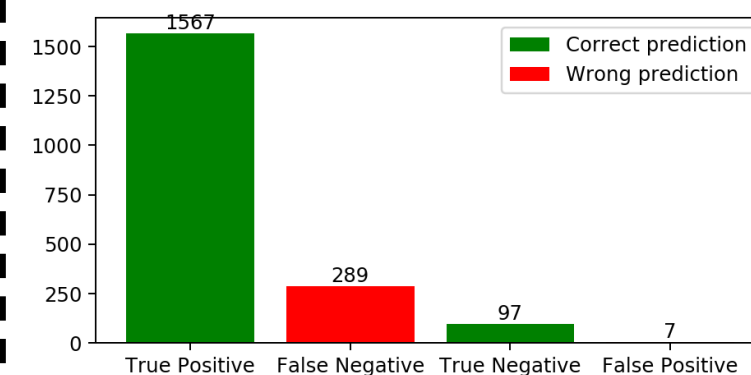

Context

- Space radiation
- SEE
- Monitoring

Thesis problematic

SAM3X8E microcontroller

Data set Creation

- Laser testing
- Simulation

Anomaly detection toolbox

- Data Set presentation
- Classification

Work in progress

Anomaly Detection Toolbox

Classification

- > Latch-up case
 - Anti latch-up system > Learning algorithm
- > μ Latch-up case
 - Learning algorithm > Anti latch-up system

Context

- Space radiation
- SEE
- Monitoring

Thesis problematic

SAM3X8E microcontroller

Data set Creation

- Laser testing
- Simulation

Anomaly detection toolbox

- Data Set presentation
- Classification

Work in progress

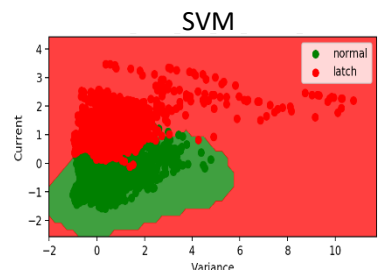
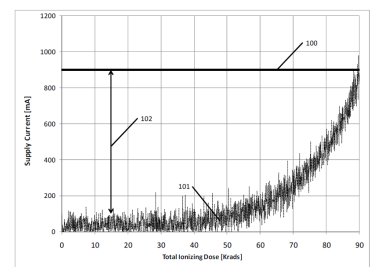

Results on simulated data set

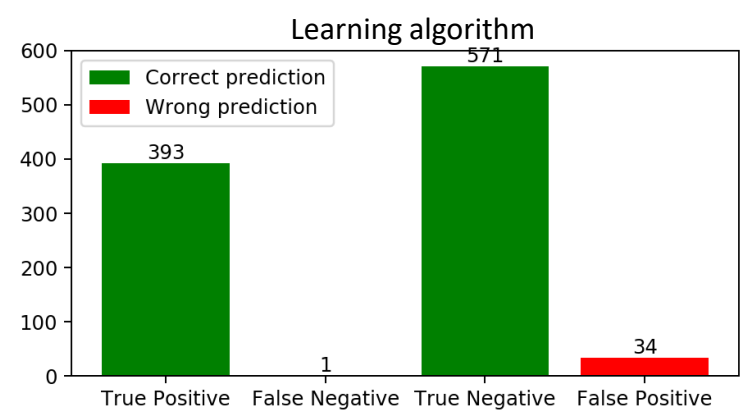
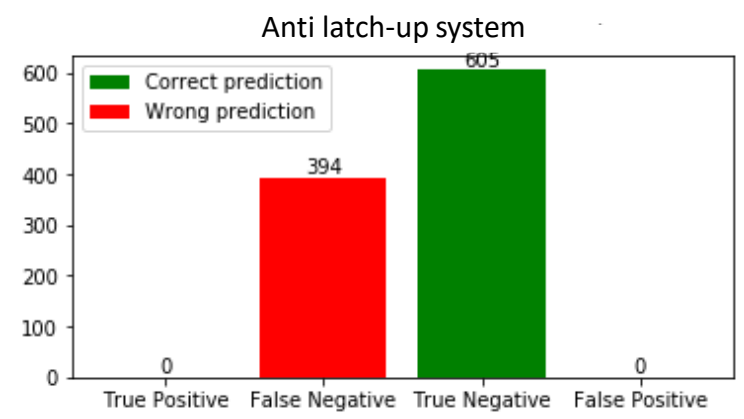

Results on real data set

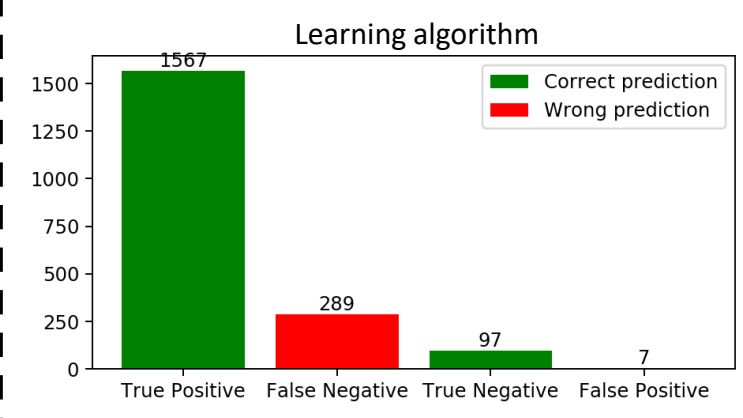
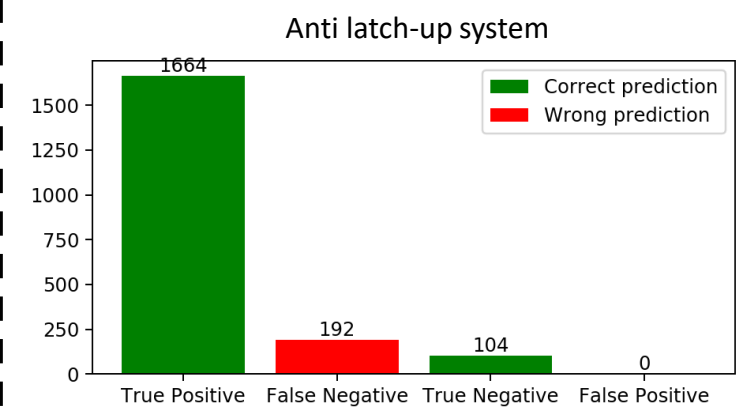

Work in progress

> With Classification algorithm

- Hypothesis of known defect

In reality, we do not have latch-up information



Semi-supervised learning

> Next steps

- Non/semi-supervised learning
 - Clustering
 - DyClee
- Add more normal class
- Neural Network to improve learning of normal behaviours

Kmeans Clustering

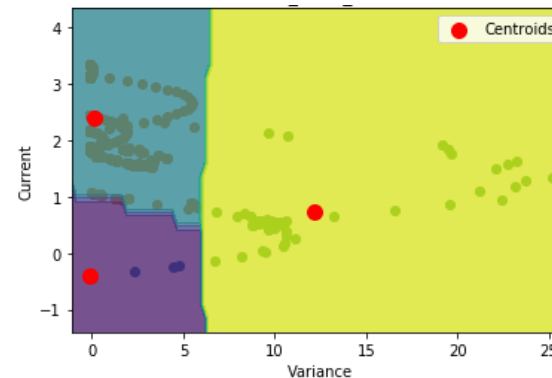

Multiple normal labels

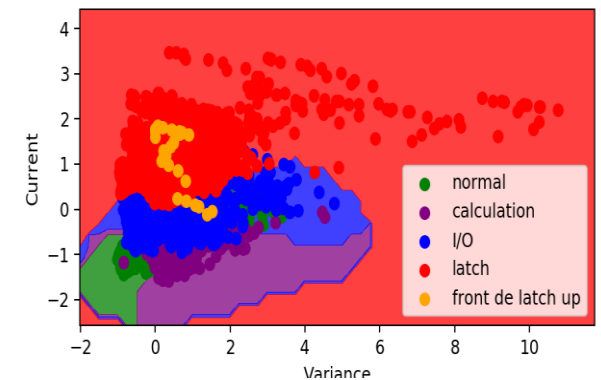

Context

- Space radiation
- SEE
- Monitoring

Thesis problematic

SAM3X8E microcontroller

Data set Creation

- Laser testing
- Simulation

Anomaly detection toolbox

- Data Set presentation
- Classification

Work in progress

Work in progress

Context

- Space radiation
- SEE
- Monitoring

Thesis problematic

SAM3X8E microcontroller

Data set Creation

- Laser testing
- Simulation

Anomaly detection toolbox

- Data Set presentation
- Classification

Work in progress

Methodology

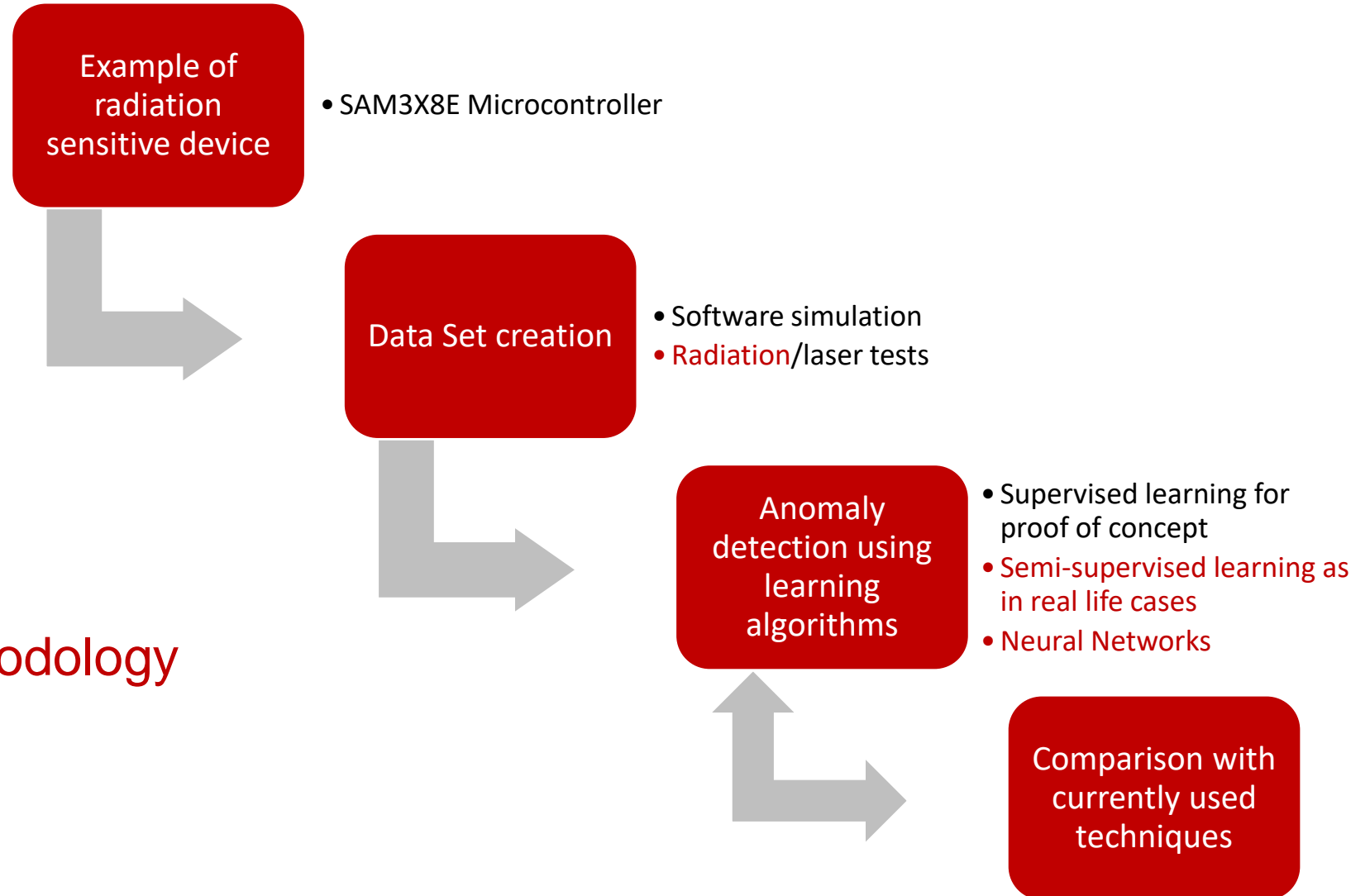

- > Jonas Bikerland Carlsen, Thesis: Design and Validation of Two Single Event Latch-up Protection Solutions : Comparing a New Single Event Latch-up Test Circuit with the IDEAS IDE3466 Single Event Latch-up Detection Module, 2018
- > Sébastien Renard. Évaluation des effets des neutrons atmosphériques sur l'électronique embarqué en avionique et recherche de solutions de durcissement. Autre [cond-mat.other]. Université Sciences et Technologies - Bordeaux I, 2013. Français. NNT : 2013BOR15253. tel-01015741
- > Chandola, Varun & Banerjee, Arindam & Kumar, Vipin. (2009). Anomaly Detection: A Survey. ACM Comput. Surv.. 41. 10.1145/1541880.1541882.
- > Nathalie Barbosa Roa, Louise Travé-Massuyès, Victor Hugo Grisales. DyClee: Dynamic clustering for tracking evolving environments. Pattern Recognition, Elsevier, 2019, 94, pp.162-186.10.1016/j.patcog.2019.05.024.
- > Sylvain Fuertes, Gilles Picart, Jean-Yves Tournet, Lotfi Chaari, André Ferrari, et al.. Improving Spacecraft Health Monitoring with Automatic Anomaly Detection Techniques. 14th International Conference on Space Operations (SpaceOps 2016), May 2016, Daejeon, South Korea. pp. 1. fhal01490731f
- > Scikit-learn: Machine Learning in Python, Pedregosa et al., JMLR 12, pp. 2825-2830, 2011.
- > C. Truong, L. Oudre, N. Vayatis. Selective review of offline change point detection methods. Signal Processing, 167:107299, 2020
- > INVAP/Roberto Manuel CIBILS : Method for updating the reference threshold of at least one operational parameter, protection unit for the mitigation of a single event latchup (SEL) in an electronic device using the reference threshold and arrangement for the mitigation of a single event latchup (SEL) in an array.

Context

- Space radiation
- SEE
- Monitoring

Thesis problematic

SAM3X8E microcontroller

Data set Creation

- Laser testing
- Simulation

Anomaly detection toolbox

- Data Set presentation
- Classification

Work in progress

Thank you !

adrien.dorise@laas.fr