



ESCCON

09/03/2021



# *Creation of a database for single events latch-up detection on Atmel SAM3X microcontroller*

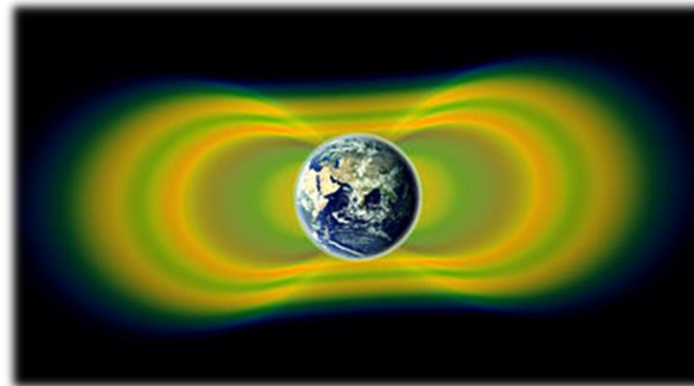
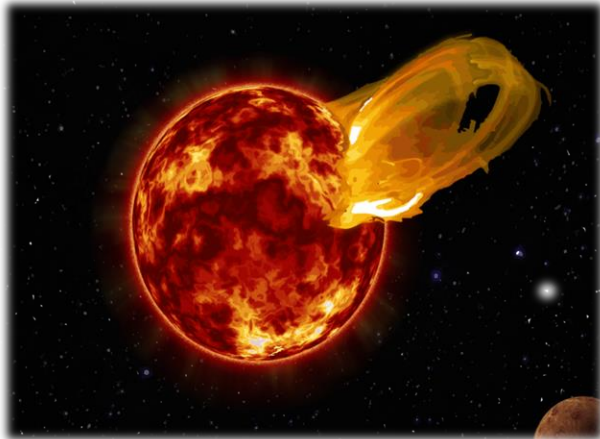

**PhD student : Adrien Dorise**  
**Thesis supervisors : Louise Travé-Massuyès**  
**Corinne Alonso**  
**Audine Subias**  
**François Vacher**  
**Leny Baczkowsky**  
**Thomas Torloting**

**Grant by CNES – région Occitanie**

- Context
- Data sets
- Features
- Electronic board
- Anomaly detection

- > SEEs in a micro-electronic device are caused by a single energetic particle and can take many forms.
  - Single Event Upset (SEU) is a logical change of state by one ionizing particle striking a sensitive node.
  - **Single Event Latch up (SEL):** Consumption current modification due to the creation of a low-impedence path triggering a parasitic structure, possibly leading to the destruction of the component. A power cycle is required to correct the situation.

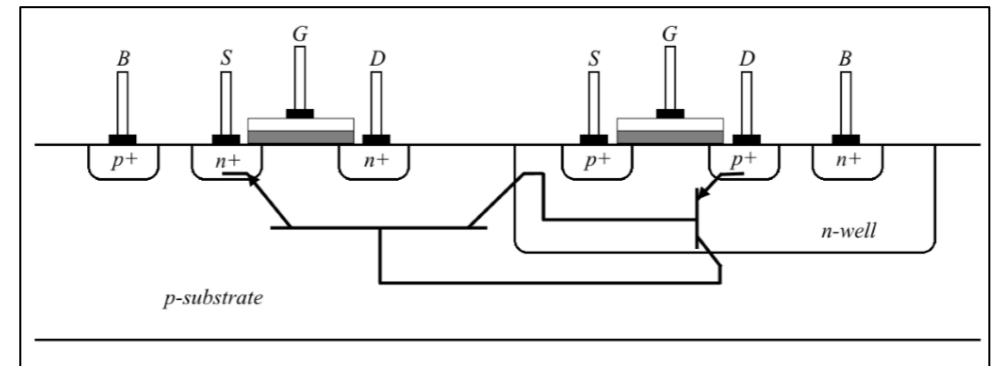
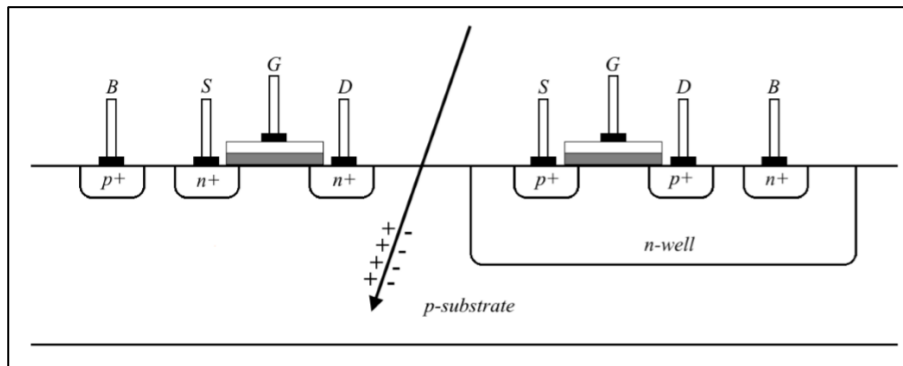

Ionizing particle hitting the semi-conductor

Source: Jonas Bikerland Carlsen, 2018

- Context
- Data sets
- Features
- Electronic board
- Anomaly detection

- > **μLatch-up**: Non destructive latch up
  - Consequence => High Current Event (HCE)
  - Can be hard to detect because lost in the original signal.
  - Persistent without a power reset.

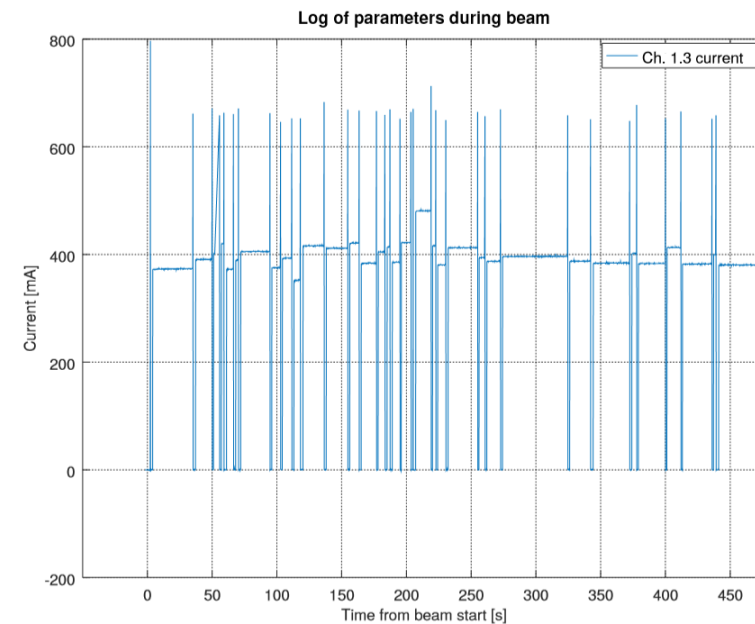
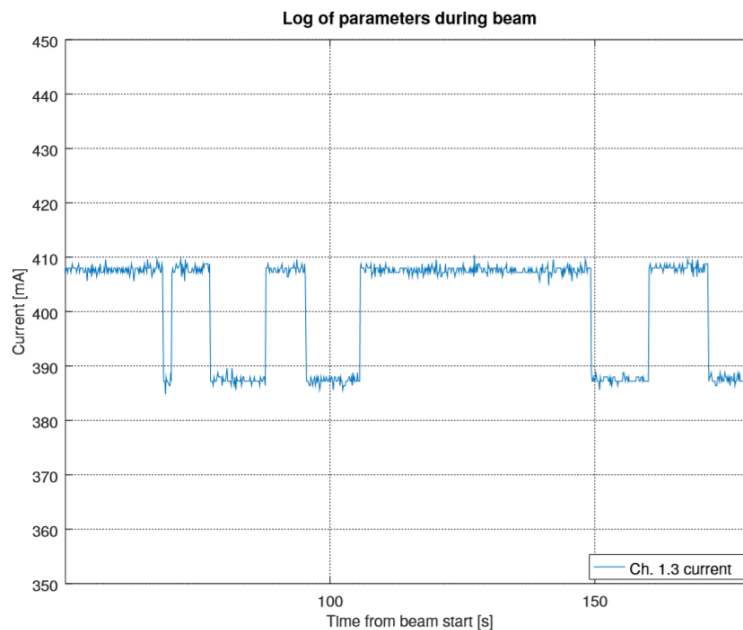

Radiation testings on Raspberry pi 3

Source: Jonas Bikerland Carlsen, 2018

- Context
- Data sets
- Features
- Electronic board
- Anomaly detection

- Shielding (protect against radiation dose)
  - Hardening
  - Anti latch-up system
- Expensive

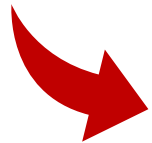

Impossible to detect  $\mu$ Latch-up

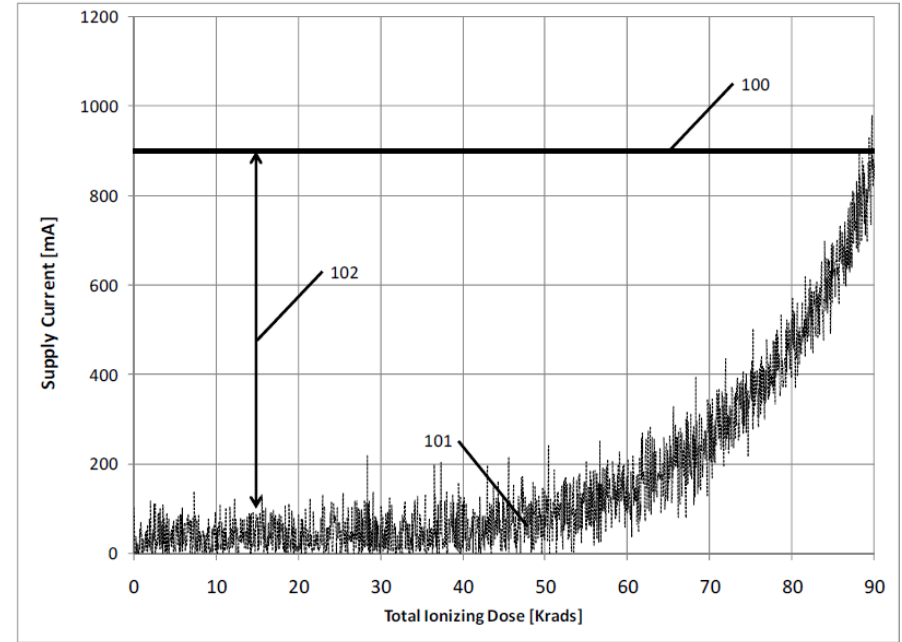

Anti latch-up system example

# Data Sets

- Context
- Data sets
- Features
- Electronic board
- Anomaly detection

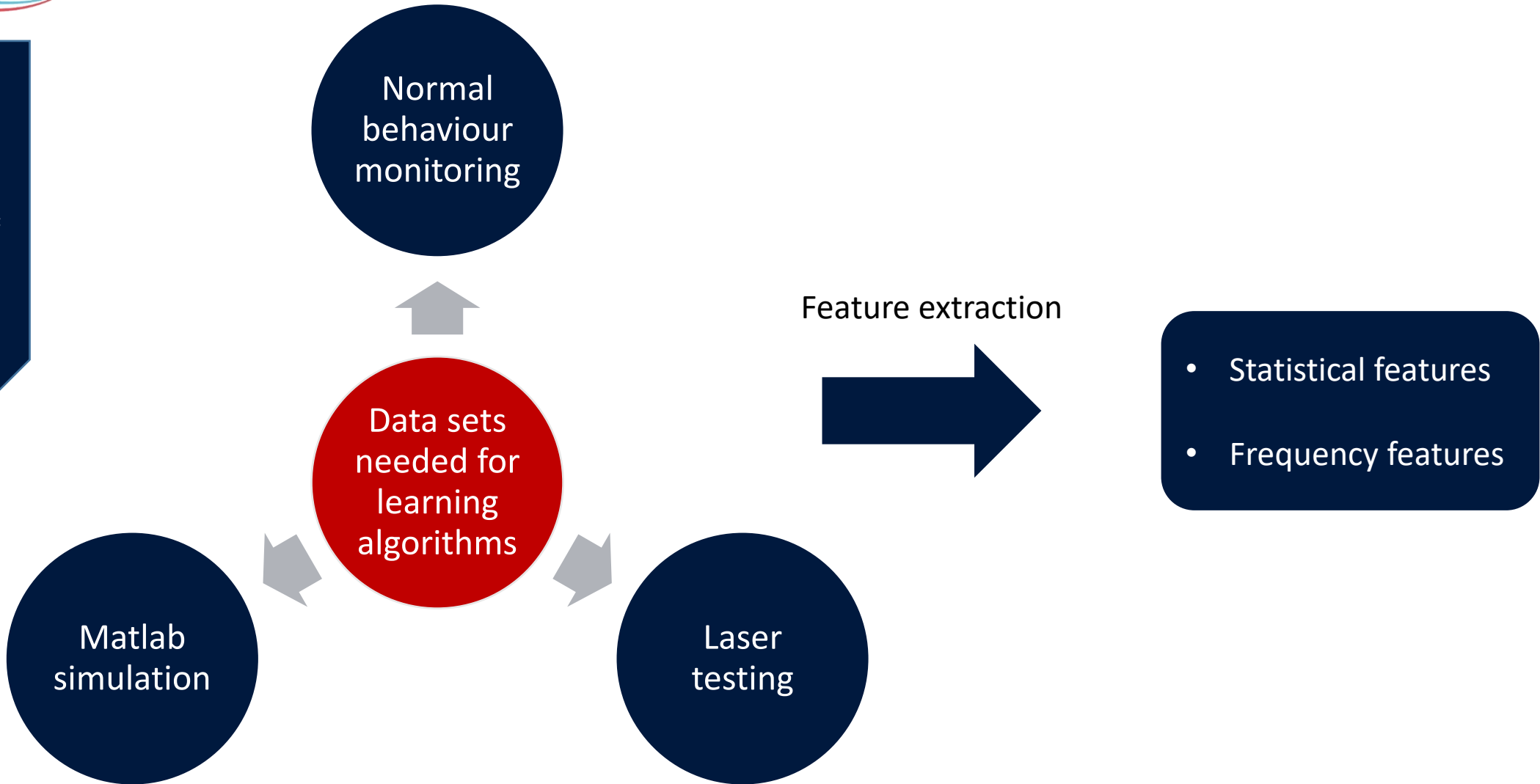

# Data Sets

- Context
- Data sets
- Features
- Electronic board
- Anomaly detection

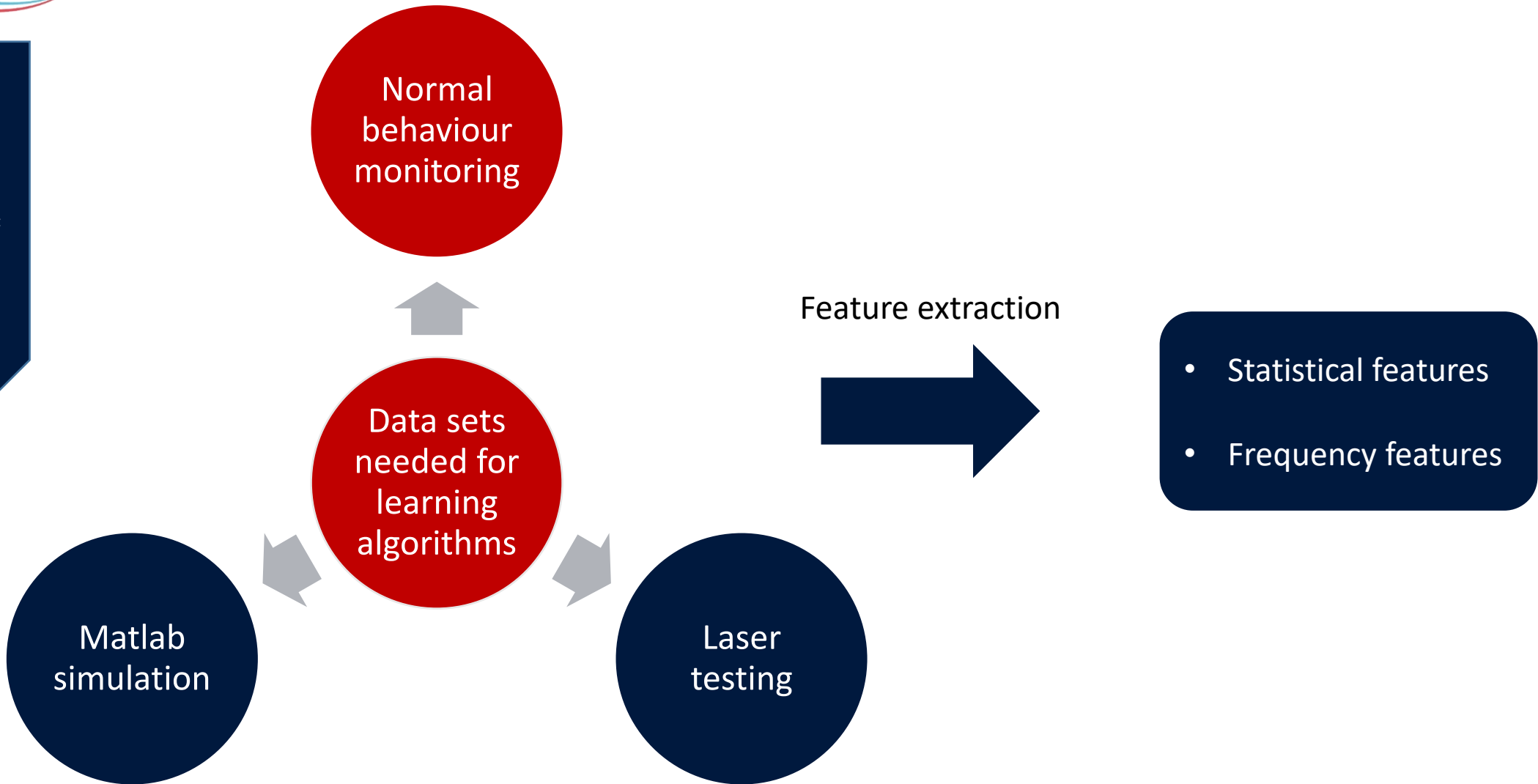

# Data Sets

Normal behaviour monitoring

Arduino Due board equipped with a SAM3X8E microcontroller used for tests

- Not the hardened version
- 32 bits Cortex-M3 core
- ARMv7-M architecture
- 84 MHz clock speed

- Context
- Data sets
- Features
- Electronic board
- Anomaly detection

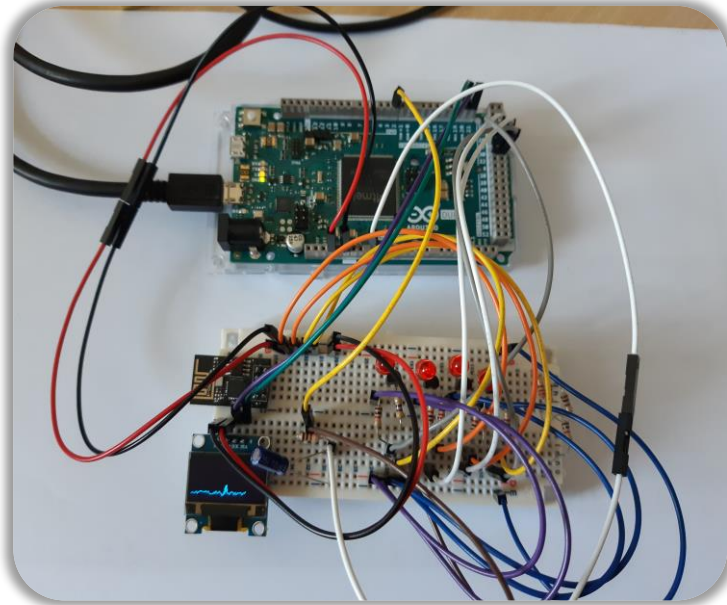

Arduino Due

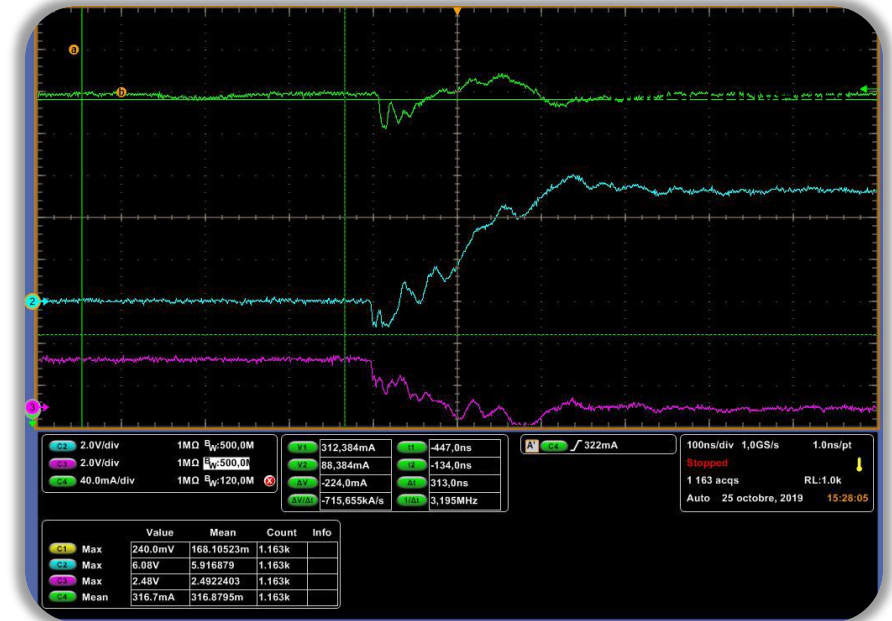

Consumption current on Boost converter

# Data Sets

## Normal behaviour monitoring

- > 2 major consumption profiles
- > Functions significantly impact consumption current of the SAM3X8E microcontroller

- Context
- Data sets
- Features
- Electronic board
- Anomaly detection

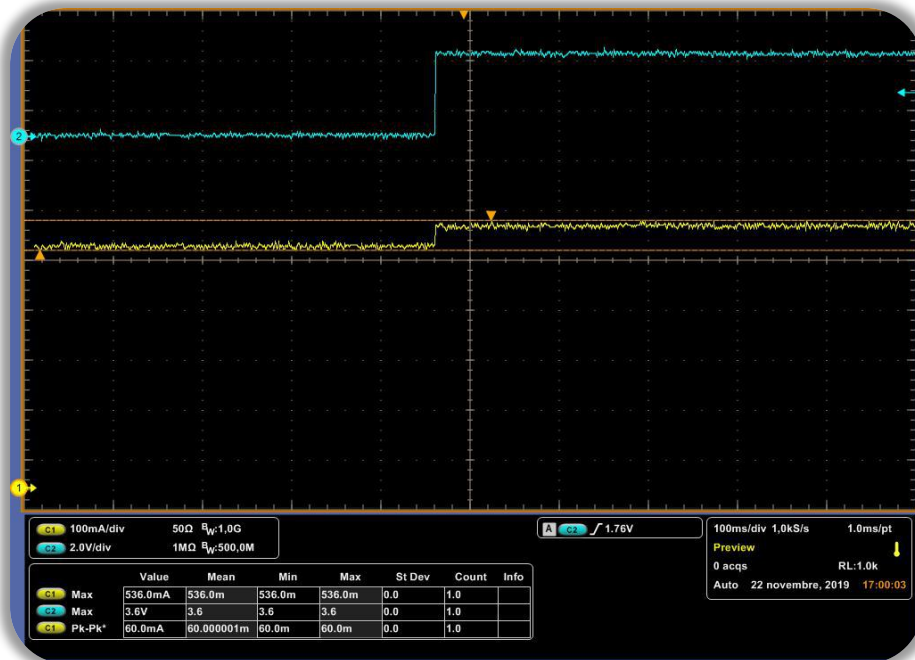

I/O consumption

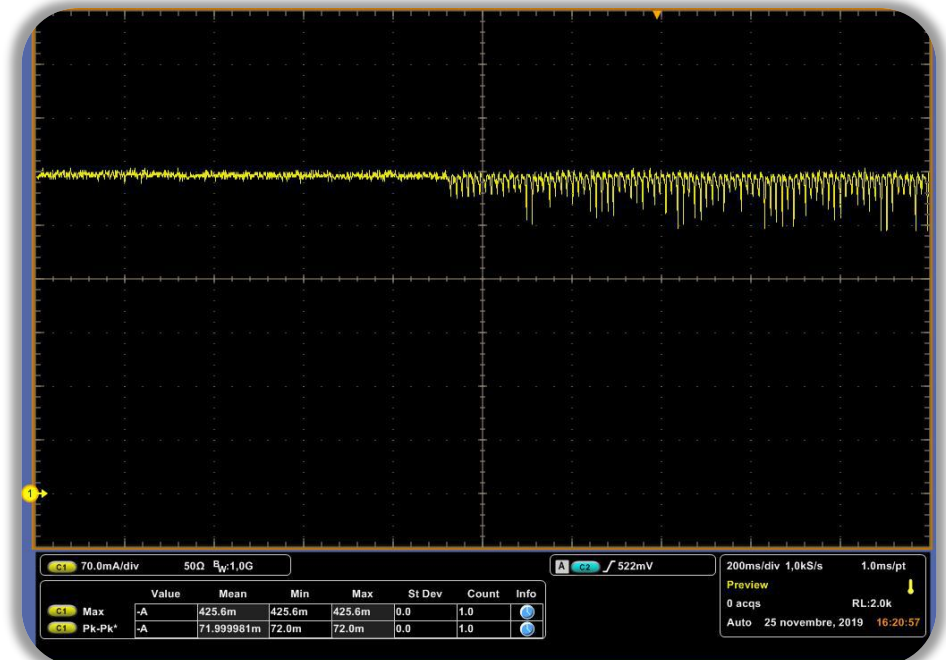

Software consumption



# Data Sets

- Context
- Data sets
- Features
- Electronic board
- Anomaly detection

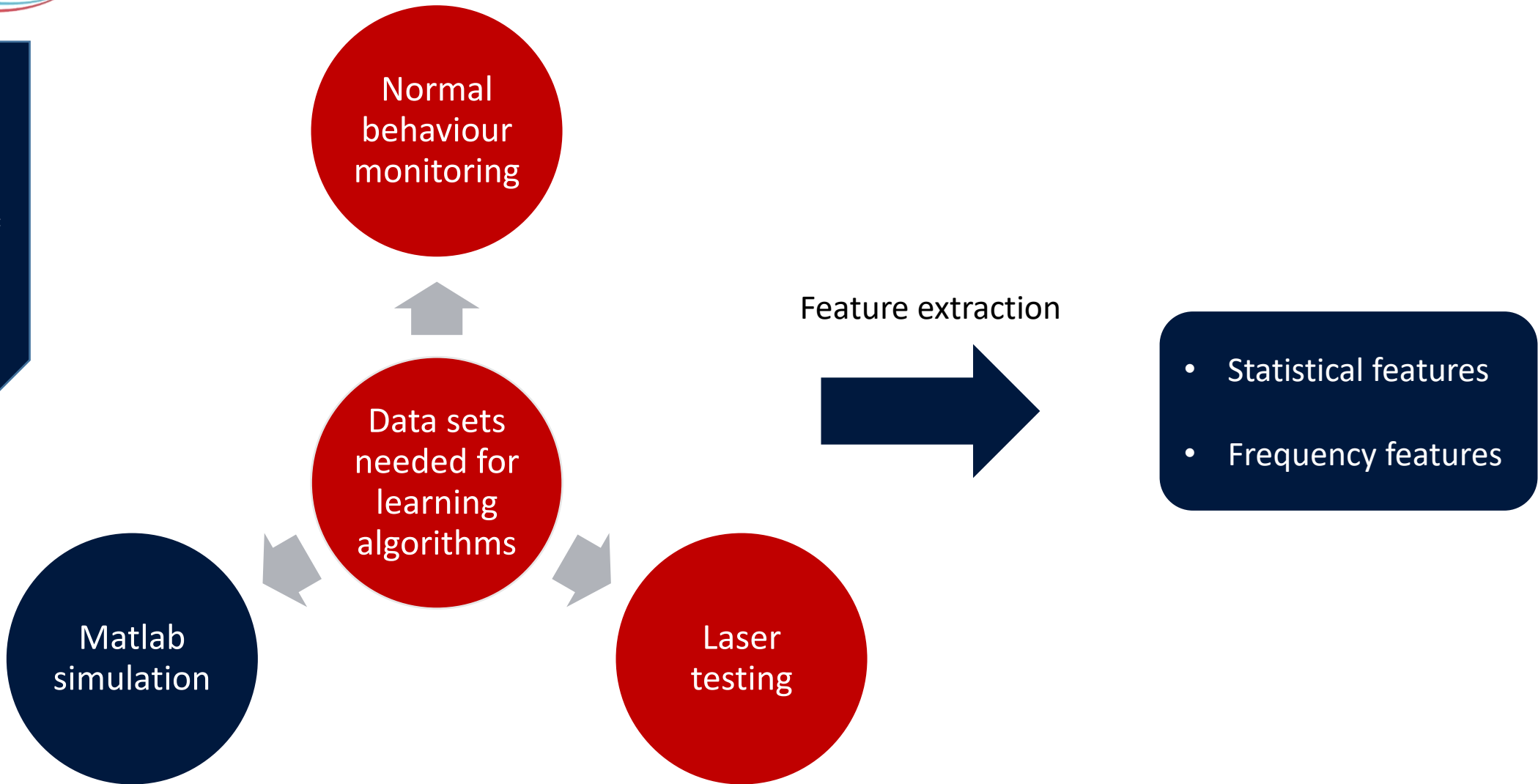

# Data Sets

Laser testing

- Context
- Data sets
- Features
- Electronic board
- Anomaly detection

Max Power	Wavelength $\lambda$	Pulse repetition frequency
2500 mW	1064 nm	8 KHz

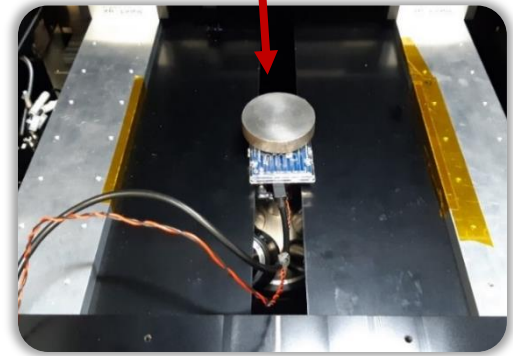
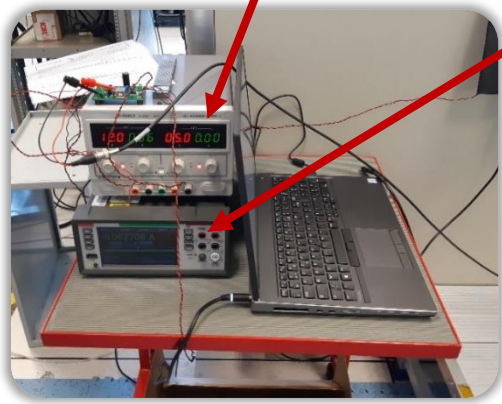
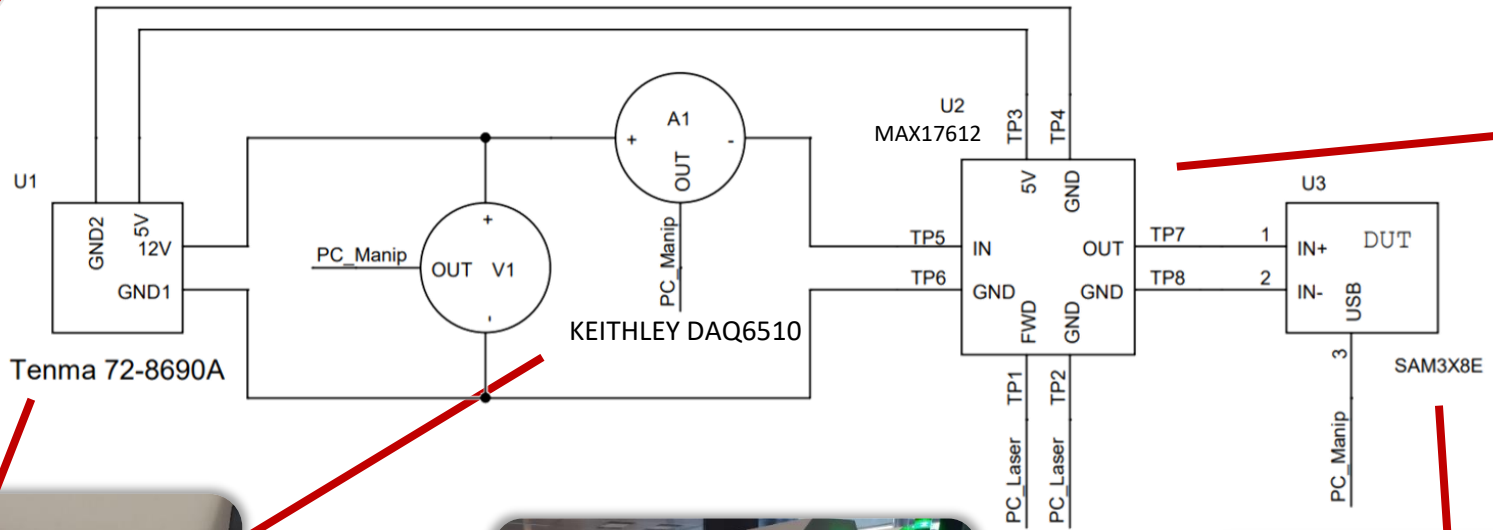

Laser bench, CNES Toulouse

# Data Sets

Laser testing

- Context
- Data sets
- Features
- Electronic board
- Anomaly detection

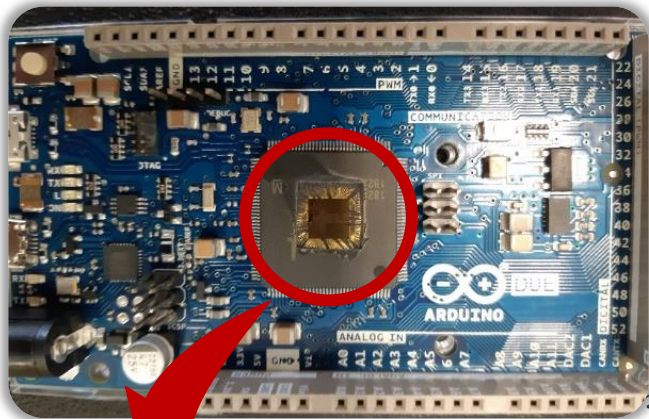

2 types of faults occurred during the laser testing

- Current faults
- Latch-up

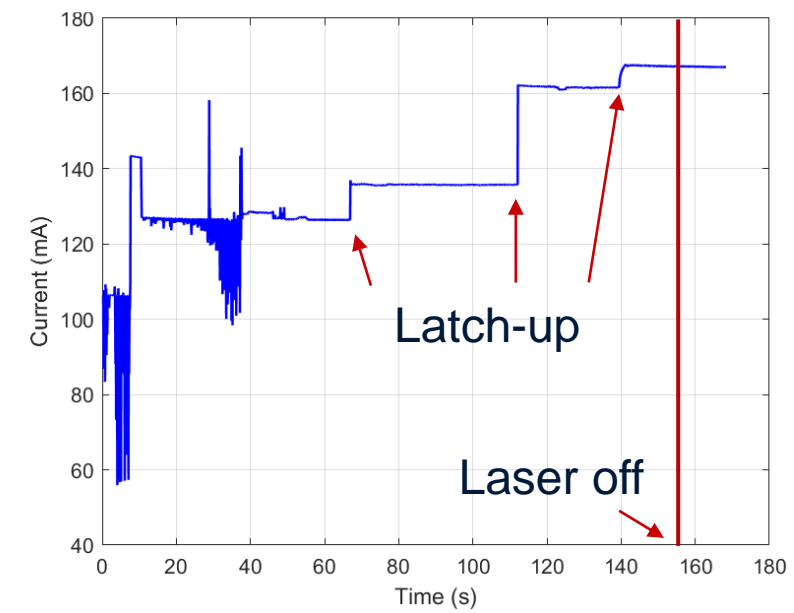
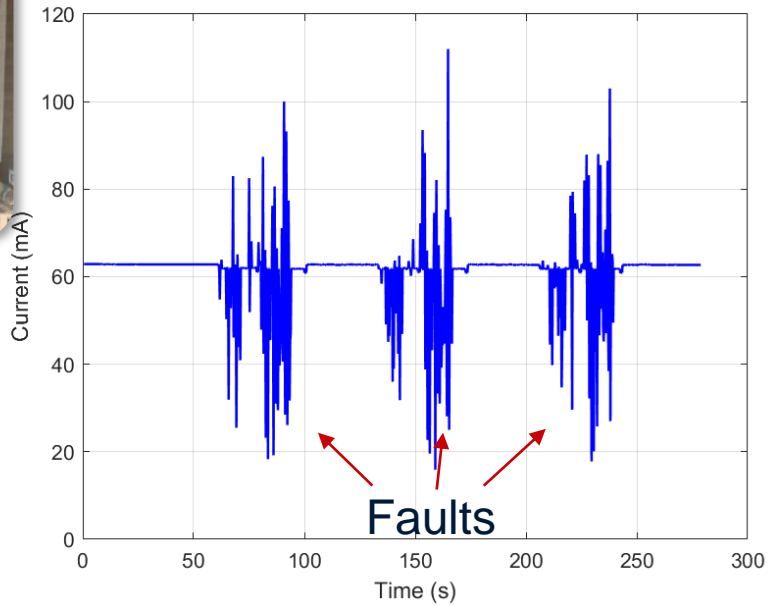

# Data Sets

- Context
- Data sets
- Features
- Electronic board
- Anomaly detection

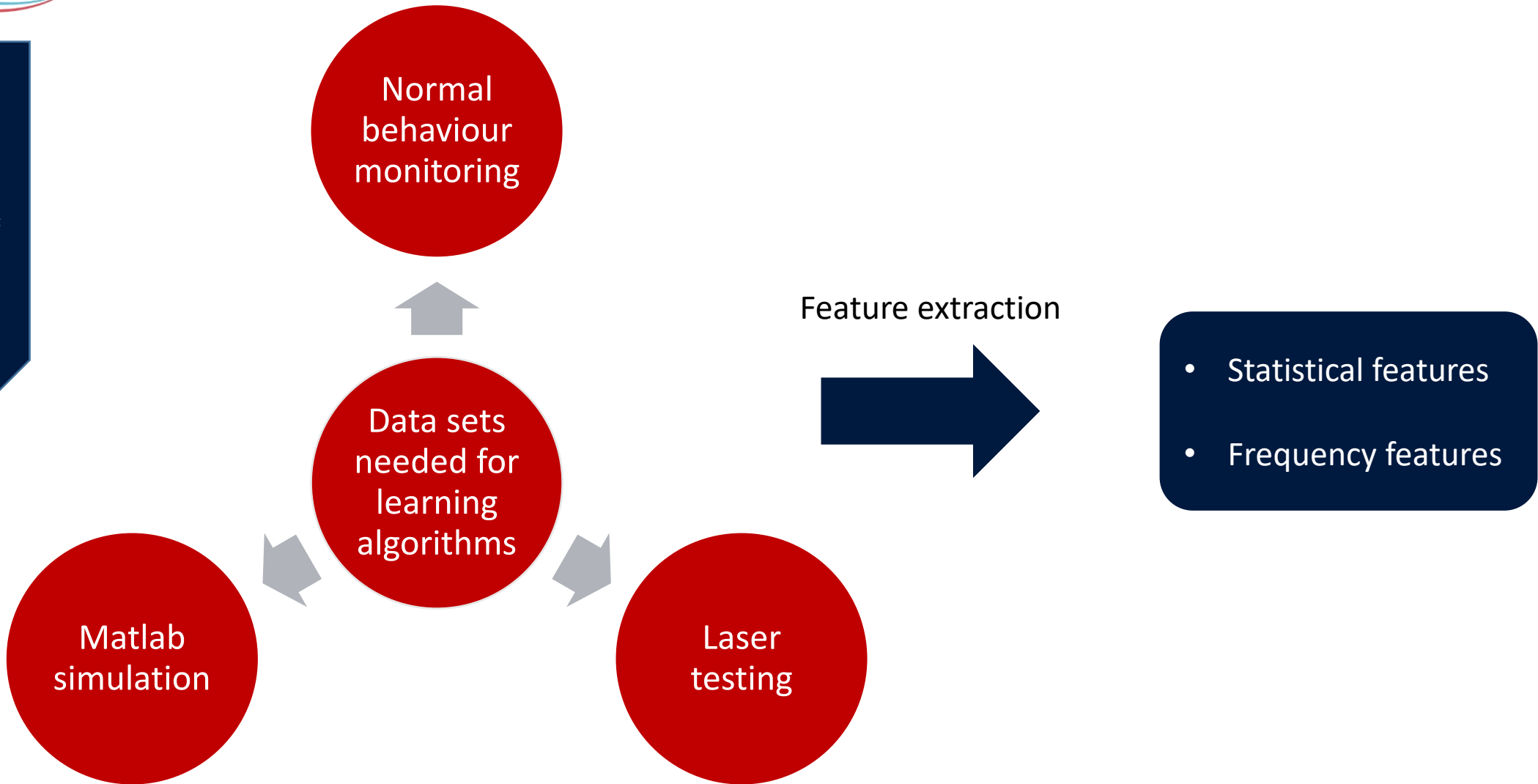

# Data Sets

Matlab simulation

- Context
- Data sets
- Features
- Electronic board
- Anomaly detection

- > Generates random data sets
- > Not a model based generator
  - Not representative of reality
  - **Mainly used to test statistical features**

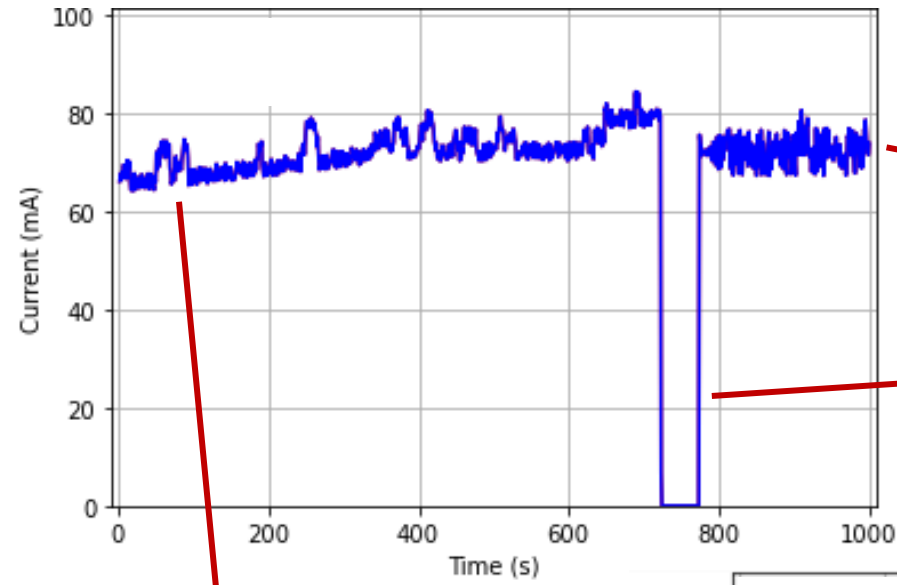

Calculation

Power cycling

I/O consumption

Temperature variation

$\mu$ Latch-up

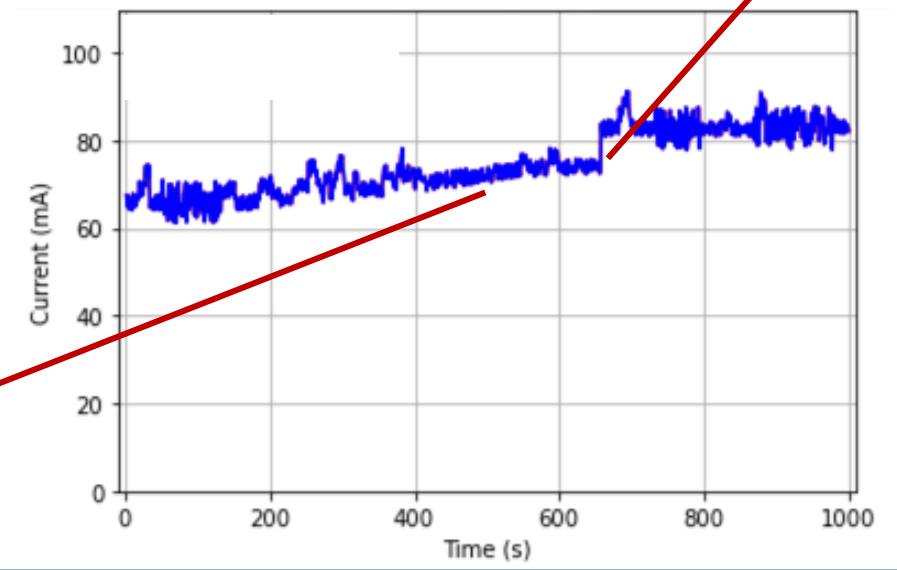

# Data Sets

- Context
- Data sets
- Features
- Electronic board
- Anomaly detection

Matlab simulation

Training Set

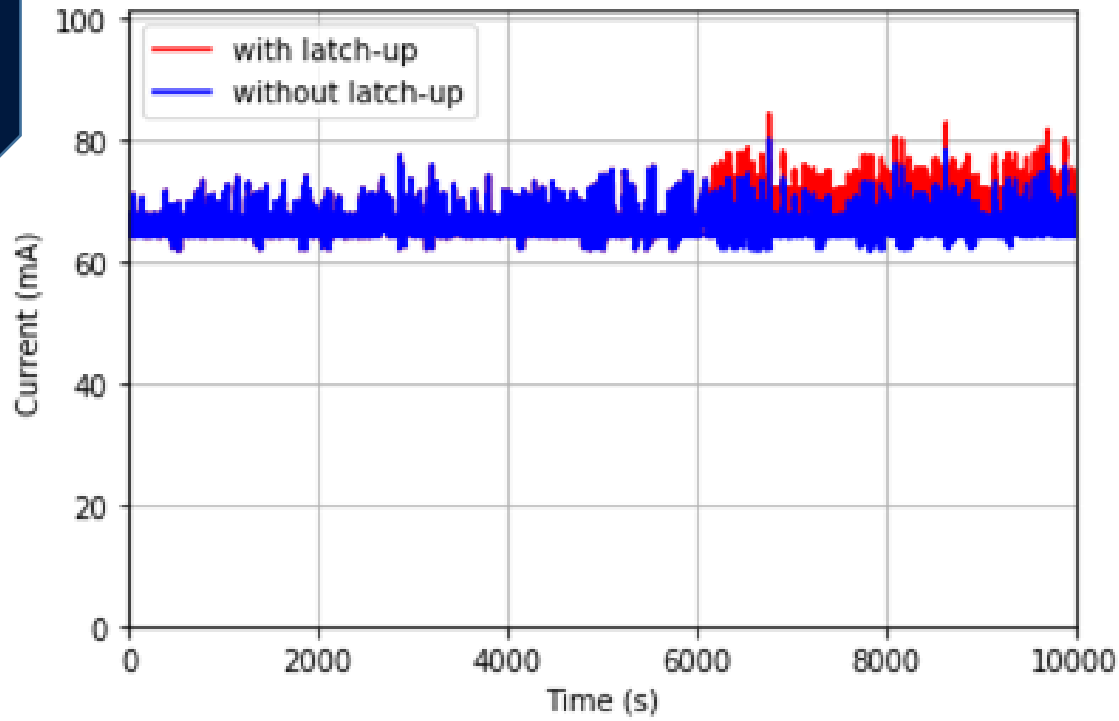

Test set

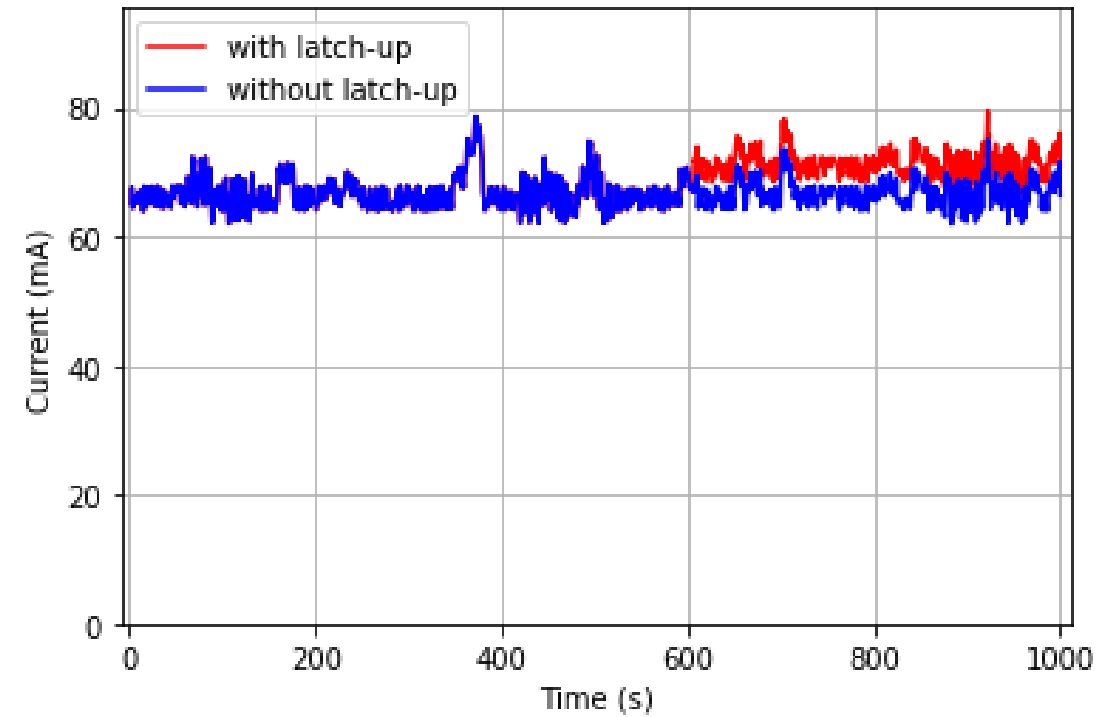

# Data Sets

- Context
- Data sets
- Features
- Electronic board
- Anomaly detection

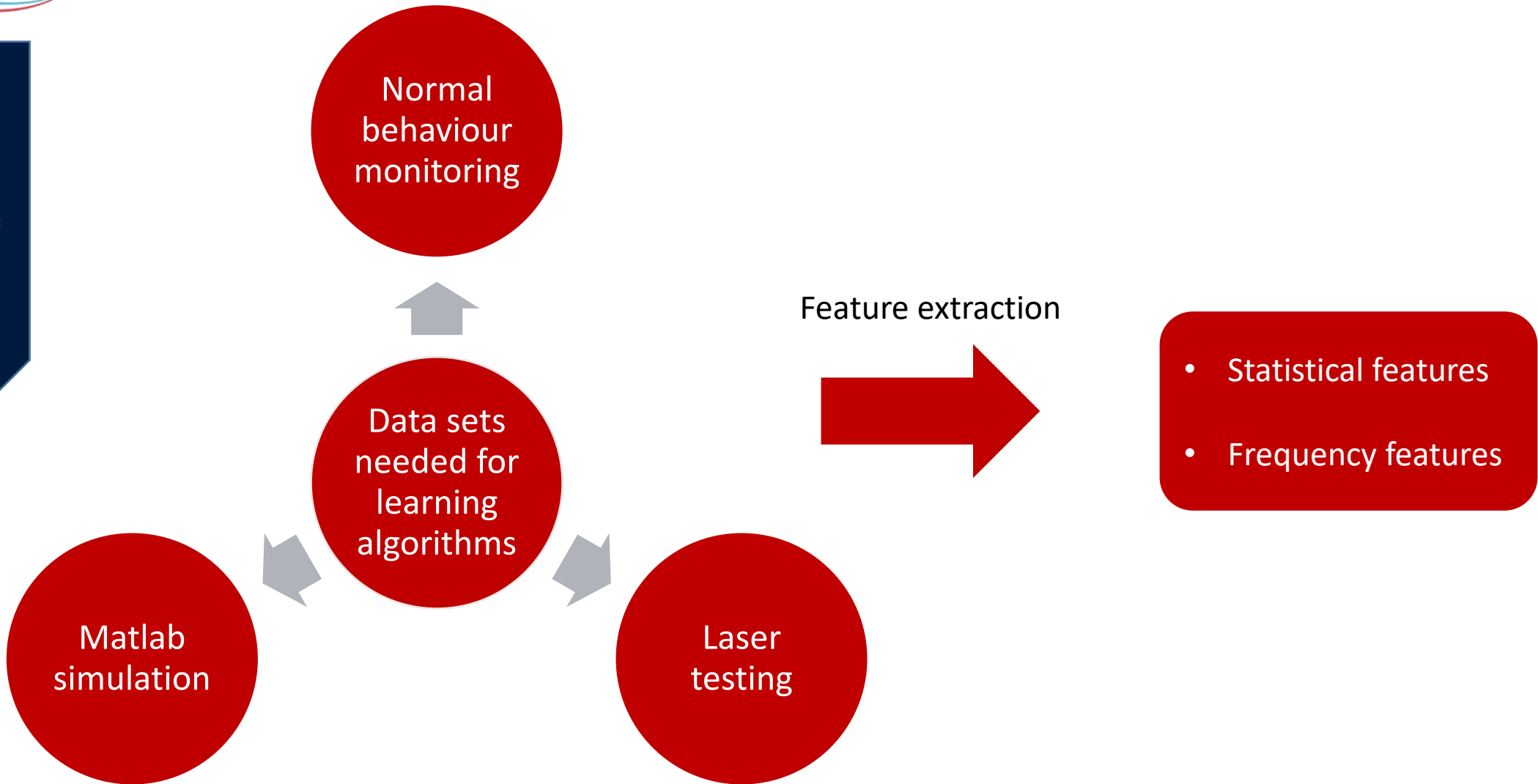

# Feature extraction

- Context
- Data sets
- Features
- Electronic board
- Anomaly detection

- Statistical features
- Frequency features

Statistical features used:

- Minimum
- Maximum
- Geometrical mean
- Variance
- Standard deviation
- Median absolute deviation
- K-statistic

Statistical features can improve detection of latch-up

Features of simulated data set

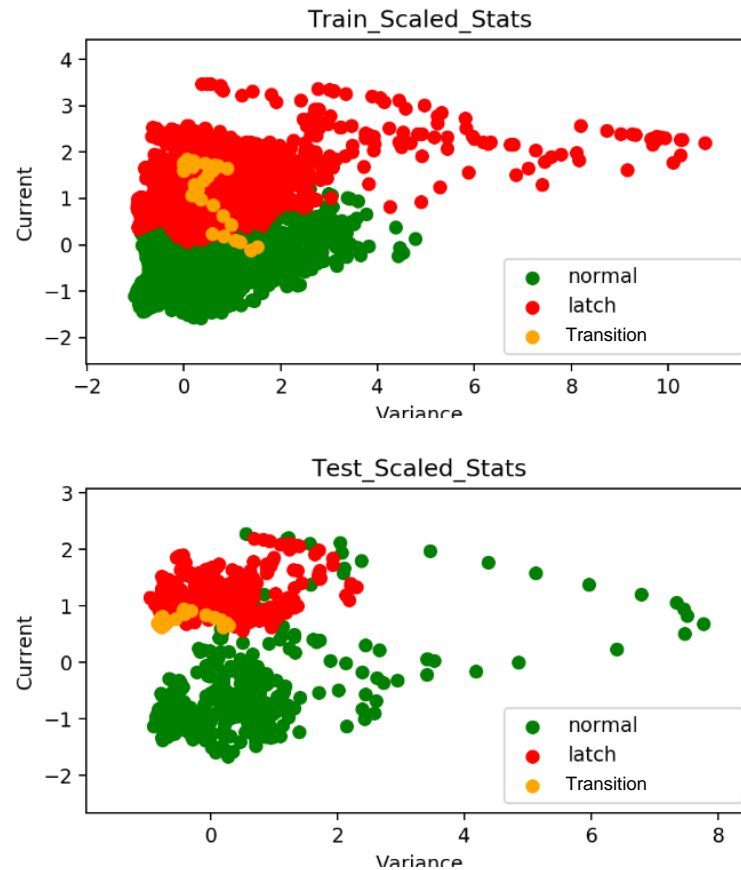

Features of real data set

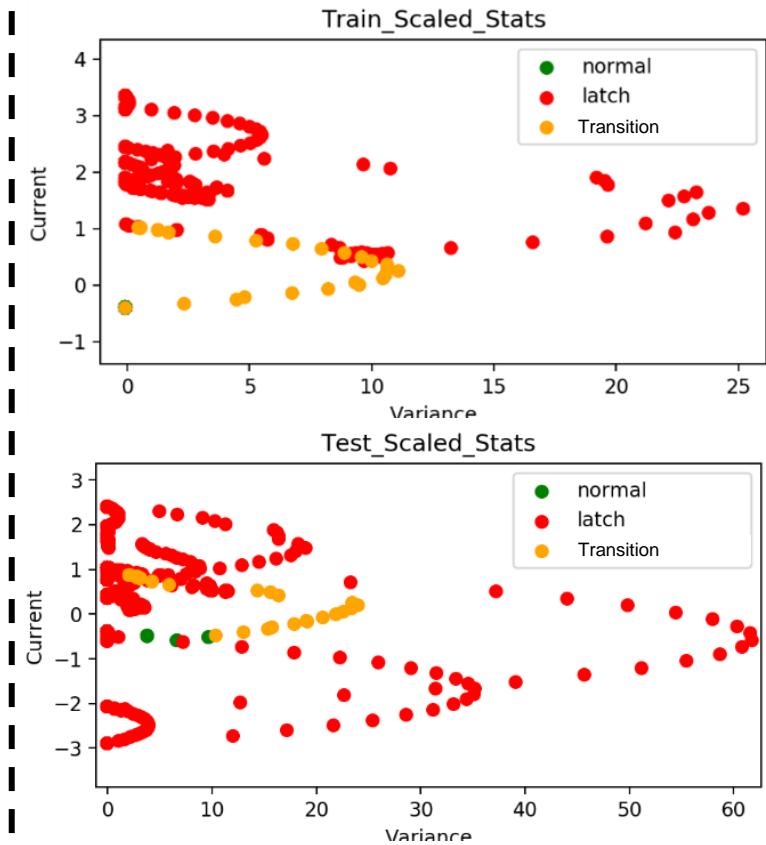



# Feature extraction

- Context
- Data sets
- Features
- Electronic board
- Anomaly detection

- Statistical features
- Frequency features

- > Acquisition frequency limited to 2.5kHz
- > As 0Hz frequency is dominant, we remove it from the spectrum
- > **Different Fourier spectrum depending on consumption type**

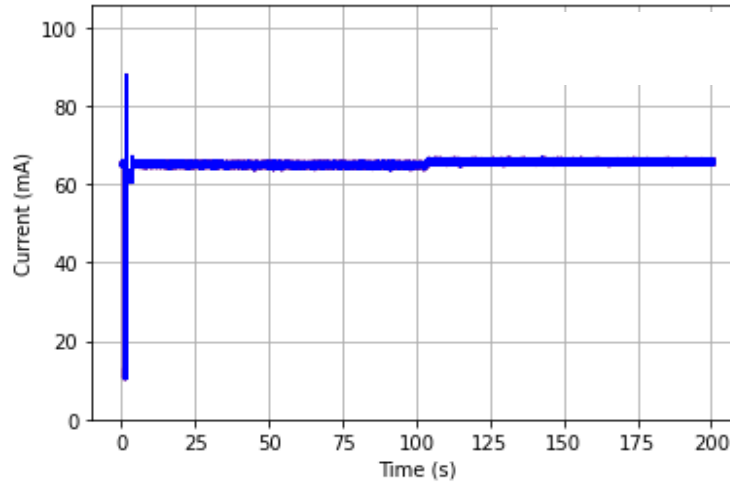

I/O consumption

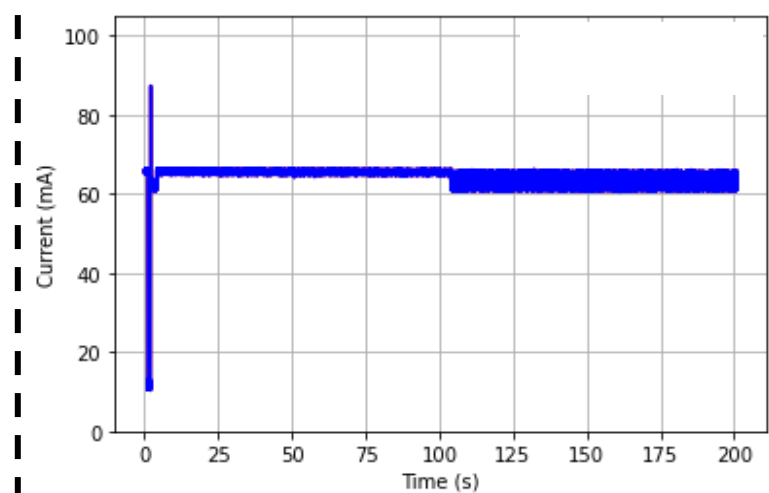
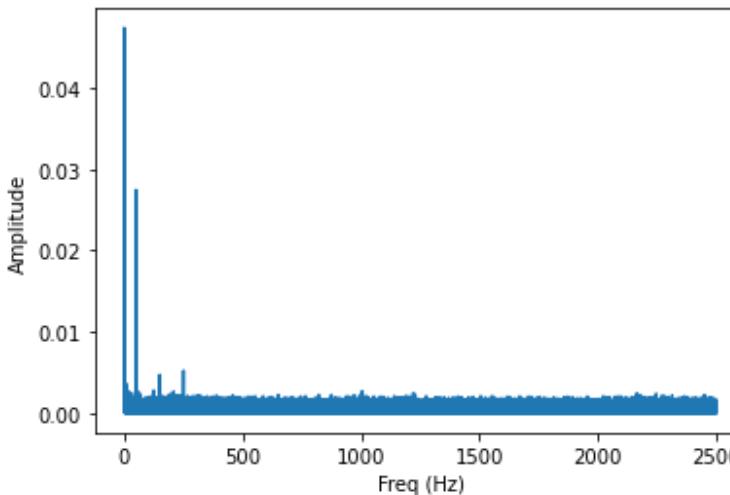

Software consumption

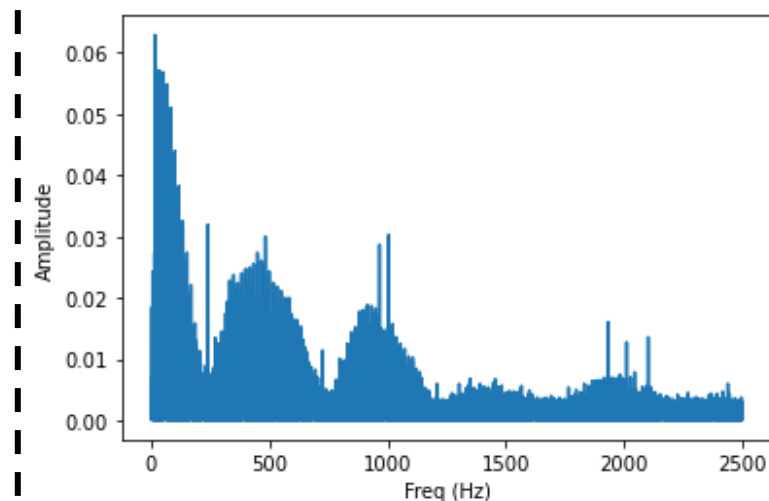

# Feature extraction

- Context
- Data sets
- Features
- Electronic board
- Anomaly detection

- Statistical features
- Frequency features

- > Latch-up frequency spectrum calculated using laser data set.
- > At the time, acquisition frequency limited to 10Hz
- > **During latch-up, vanishing of frequency peaks**

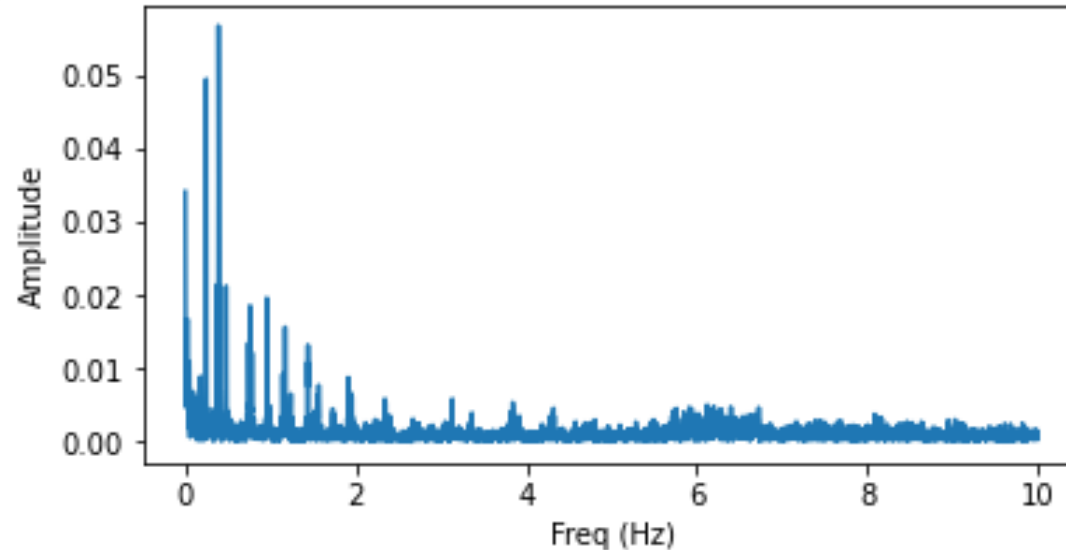

Frequency spectrum in normal conditions

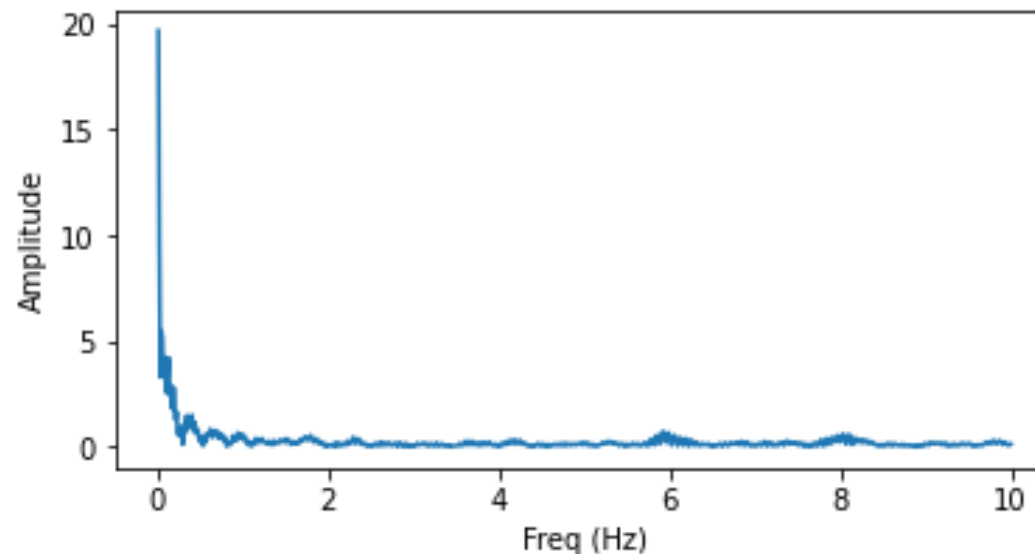

Frequency spectrum during latch-up

# Electronic board

- Context
- Data sets
- Features
- Electronic board
- Anomaly detection

- > Creation of a board specifically designed latch up data set creation
- > Mother/daughter board system to replace easily the Device Under Test in case of damage

Daughterboard

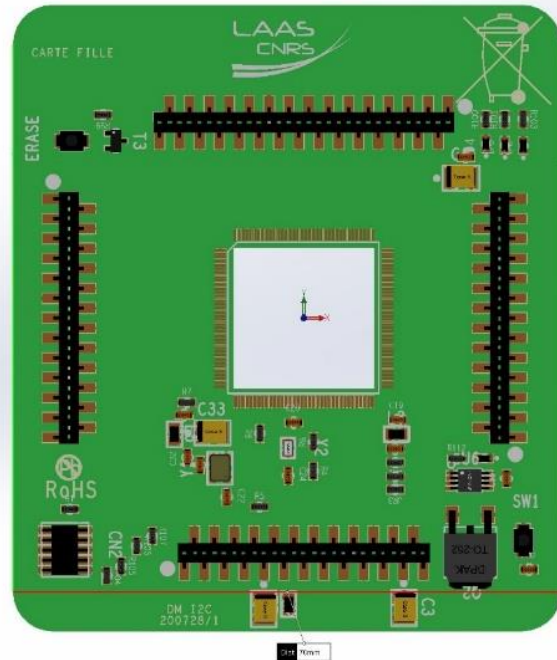

Motherboard

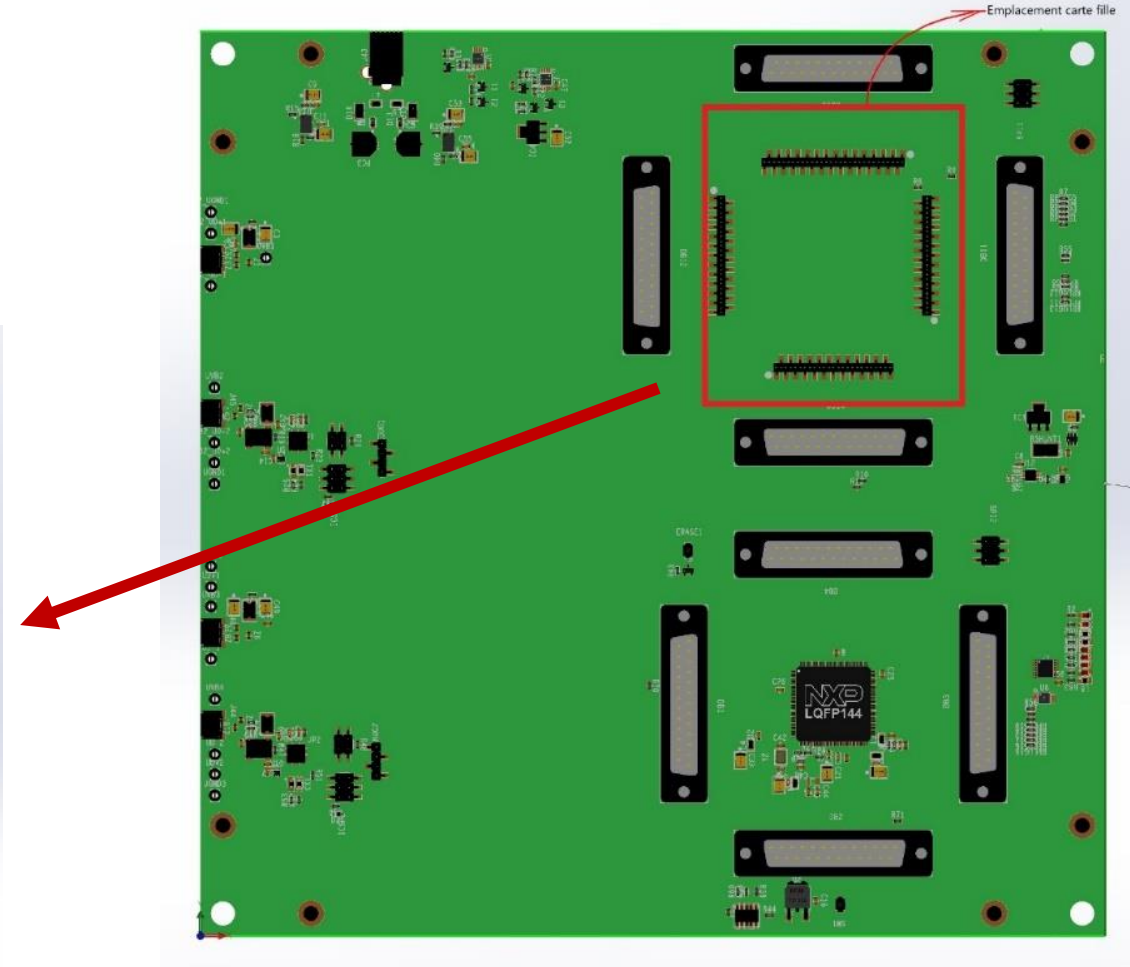

# Anomaly Detection

- Context
- Data sets
- Features
- Electronic board
- Anomaly detection

## Dyclee

- > DyClee is an algorithm developed by DISCO team in Laas
- > Distance and density based algorithm with  $\mu$ Clusters
- > Good results and online learning

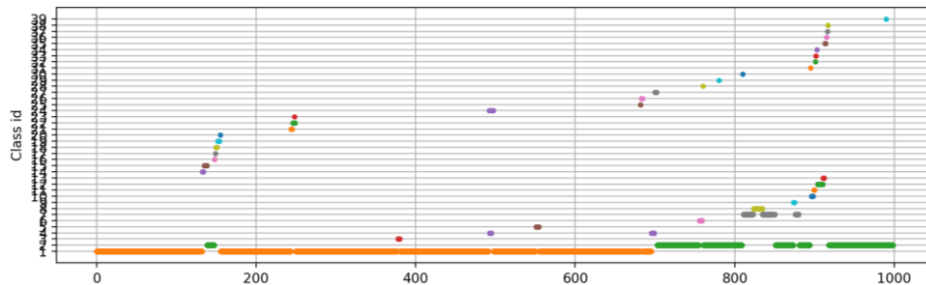
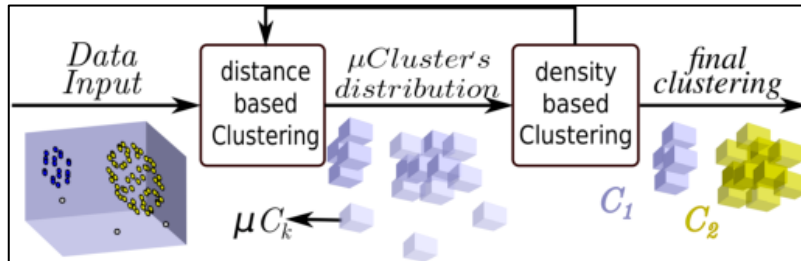

Using the features extracted before, we can use learning algorithms to detect latch-up and  $\mu$ Latch-up.

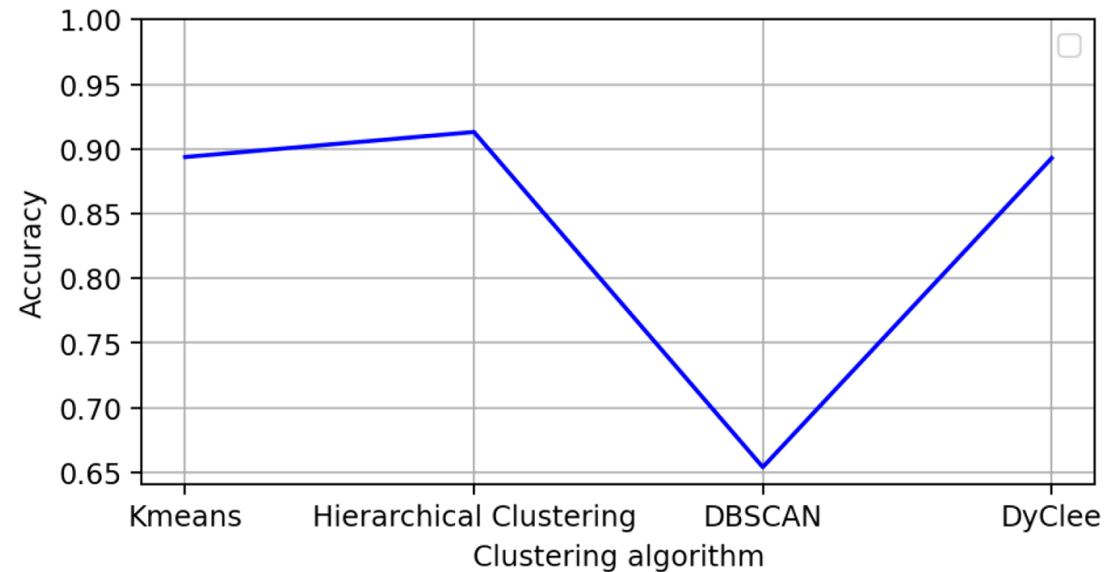

# Conclusion

- Context
- Data sets
- Features
- Electronic board
- Anomaly detection

- > Data set created to train latch-up detection algorithms
  - Real data sets
  - Simulated data sets
- > Features extraction to characterize latch-up anomalies
  - Statistical features
  - Frequency features
- > In the future
  - Get more real latch-up data
  - Improve Matlab simulator

- Context
- Data sets
- Features
- Electronic board
- Anomaly detection

- > Jonas Bikerland Carlsen, Thesis: Design and Validation of Two Single Event Latch-up Protection Solutions: Comparing a New Single Event Latch-up Test Circuit with the IDEAS IDE3466 Single Event Latch-up Detection Module, 2018
- > Sébastien Renard. Évaluation des effets des neutrons atmosphériques sur l'électronique embarqué en avionique et recherche de solutions de durcissement. Autre [cond-mat.other]. Université Sciences et Technologies - Bordeaux I, 2013. Français. NNT : 2013BOR15253. tel-01015741
- > Robert Ecoffet: In-orbit anomalies due to radiation. Lessons learnt, ESCCON 2011.
- > Nathalie Barbosa Roa, Louise Travé-Massuyès, Victor Hugo Grisales. DyClee: Dynamic clustering for tracking evolving environments. Pattern Recognition, Elsevier, 2019, 94, pp.162-186.10.1016/j.patcog.2019.05.024.
- > INVAP/Roberto Manuel CIBILS: Method for updating the reference threshold of at least one operational parameter, protection unit for the mitigation of a single event latchup (SEL) in an electronic device using the reference threshold and arrangement for the mitigation of a single event latchup (SEL) in an array.
- > Adrien Dorise: SEE detection (HCE) with Machine Learning algorithm on Atmel SAM3X microcontroller, ADCSS2020

# Thank you !

adrien.dorise@laas.fr