



HAL
open science

Towards a Wearable Detection Prevention System for Elderly Protection Using Gas-Generating Energetic Composites

Felipe Augusto Sodr  Ferreira de Sousa

► **To cite this version:**

Felipe Augusto Sodr  Ferreira de Sousa. Towards a Wearable Detection Prevention System for Elderly Protection Using Gas-Generating Energetic Composites. Congr s annuel de l'Ecole Doctorale GEETS, Apr 2022, Toulouse, France. hal-03599441

HAL Id: hal-03599441

<https://laas.hal.science/hal-03599441>

Submitted on 7 Mar 2022

HAL is a multi-disciplinary open access archive for the deposit and dissemination of scientific research documents, whether they are published or not. The documents may come from teaching and research institutions in France or abroad, or from public or private research centers.

L'archive ouverte pluridisciplinaire **HAL**, est destin e au d p t et   la diffusion de documents scientifiques de niveau recherche, publi s ou non,  manant des  tablissements d'enseignement et de recherche fran ais ou  trangers, des laboratoires publics ou priv s.

Towards a Wearable Detection Prevention System for Elderly Protection Using Gas-Generating Energetic Composites

Felipe Augusto SODRE FERREIRA DE SOUSA

LAAS-CNRS – 7 Avenue du Colonel Roche, 31031 Toulouse

This study presents a low-power wearable system able to predict a fall by detecting a pre-impact condition, performed through a simple analysis of motion data (acceleration) and height of the subject. The entire detection system uses a single wearable tri-axis accelerometer placed on the waist for the comfort of the wearer during a long-term application. As soon as an imminent fall condition is reached, a capacitive discharge ignites a device to trigger the combustion of an energetic material to generate the gas. The use of gas-generating energetic composites makes it possible to miniaturize the system and reduce weight, thus increasing comfort.

I. INTRODUCTION

Equipment for the protection and safety of people is undergoing increasing technological development. Due to the aging process of the world population, a new research sector is gaining interest, the security of the elderly. The risk of falls increases with aging¹, and it is estimated that 30% of elderly people aged 65 or older fall at least once a year^{2,3}. According to the world health organization, by 2050, one over six people in the world will be older than age 65. Approximately 1 out of 5 falls result in a serious injury, such as hip fracture, subdural hematoma, and other more serious injuries such as head injury, which can lead to death^{4,5}. However, even if a fall does not result in injury, serious psychological trauma still might occur, reducing the independence and the ability to carry out daily activities such as dressing, bathing, or housekeeping; this is the reason why falls prevention is now recognized as an important health issue within the modern countries⁶. Most of the fall detection systems (FDS)⁷⁻¹⁰ use the absence of movement, and other post-impact information to detect that a fall has occurred. These systems are interesting to reduce the rescue time, the time for the first aids arrive to help the person.

The purpose of this work is to develop a wearable system capable of predicting an impending fall and protecting the user against the impact. A prototype was developed consisting of two main parts: the fall detection system and the protection device.

II. FALL DETECTION SYSTEM

One main challenge for the FDS next generation is not to detect when the person fell

but to predict an occurring fall (pre- impact) in order to trigger a protection device, for example, an airbag to prevent the injuries and trauma^{11,12}. It requires to accurately distinguishing a fall from the activities of daily living (ADL) i.e. walking, sitting. The majority of the existing pre-impact fall detection systems are wearable-sensor-based^{11,12} taking profit from the advancement in microelectronics and wireless communication technology. They are capable of capturing body movement unobtrusively and allow kinematic measurements to be monitored over an extended space.

A. Hardware

To facilitate the use of our system, a low-power miniaturized embedded prototype was designed and developed, which is small (50 mm × 40 mm × 1.6 mm) and light (13 g), meant to be worn on the subject's waist to analyze the acceleration signals and posture. The system is composed of a printed circuit board (PCB) (FIG. 1) that contains a single low-power tri-axis MEMS accelerometer (LIS3DH from STMicroelectronics). The sensor is scaled $\pm 8g$ and oriented with the x-axis for the left; the y-axis downward positive and the z-axis forward positive. To get the best compromise between resolution and consumption, we configured the accelerometer data output in 12-bits resolution with a sampling rate of 400 Hz.

The digital output is transferred through a serial peripheral interface (SPI) to the main component of the system, the nRF52832. This System-on-Chip (SoC) from Nordic Semiconductor is a low-power consumption SoC¹³ integrated with the Bluetooth low energy (BLE) interface, used to communicate with a

mobile device (cellphone or tablet). All of the system is powered with a 3V coin cell battery.

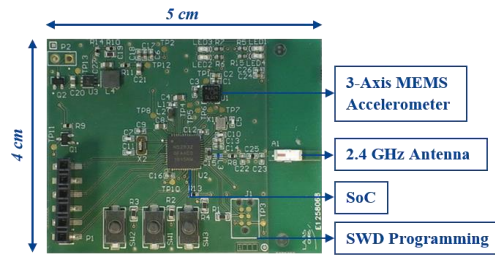

FIG. 1. Photo of the PCB of the detection system.

B. Algorithm

This section presents the methodology used to develop a customizable threshold-based pre-impact fall detection algorithm¹⁴.

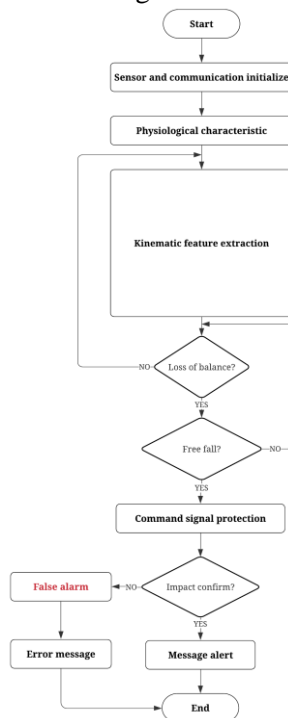

FIG. 2. Threshold-based algorithm flow chart

The algorithm is divided into three main steps (FIG. 2): the fall detection algorithm, user protection with an airbag system and a message alert for first aid.

Two categories of features are employed to detect the fall before the impact: the physiological characteristics (the user height) and sensor data (accelerometer). To improve the algorithm and the lead time response (time interval between when the fall was detected and fall impact), a second physiological characteristic was used, the distance in centimeters between the head and the PCB, as a threshold to identify a near loss of balance situation. This choice is based on the fact the height influences the balance.

The results show that this algorithm can detect falls with an average lead time of 259 ms before the impact occurs, with few false alarms (2.3%) and a capacity to detect 92.6% of the falls¹⁴.

III. FALL PROTECTION DEVICE

The actuation mechanism is provided by a nanothermite based energetic film chosen as it is a source of reliable energy, exhibiting long shelf life (decades) and able to very quickly deliver gas and heat through a self-sustained redox reaction. Al/CuO nanothermites demonstrated their capabilities to provide high-energy density actuations to fracture silicon substrates¹⁵ or disconnect circuitry¹⁶ while being safe and stable until 250 °C¹⁷.

A. Gas generation

A coordination complex $\text{Cu}(\text{NH}_3)_4(\text{NO}_3)_2$ (called CuC), was mixed with a thermite^{18–21}. NH_3 , N_2O and N_2 were identified to be the gaseous products from its decomposition. Since without external heat, CuC cannot initiate and sustain its decomposition, Al/CuO nanothermite was incorporated to act as the complementary heat source upon initiation of the whole material. These new energetic composites feature peak pressure of 12 MPa/g.cm³, which is much higher than traditional Al/CuO nanothermite.

A pressure rise rate of 41 ± 8 kPa/ μs is obtained with the optimized concentration of 75% Al/CuO and 25% Al/CuO/CuC. This proportion also reach the highest burn rate (141 ± 25 m/s)²².

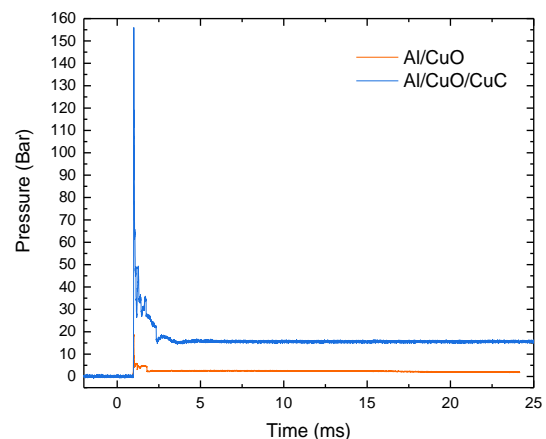

FIG. 3. Pressures of Al/CuO/CuC in comparison with the traditional Al/CuO

The energetic composites is ignited using a pyroMEMS as presented in the next section.

B. Ignition Circuit

To trigger the chemical reaction of the coordination complex for generating the gas, we use a device called pyroMEMS (pyrotechnical microsystems)^{23–25}.

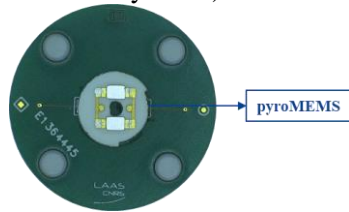

FIG. 4. Photo of a pyroMEMS assembled in a 24 mm diameter PCB.

PyroMEMS is a micro-initiator Al/CuO multilayered material. After being ignited the thin nanothermite layer produce a spark^{26,27} (FIG. 5) that ignite the CuC based energetic mixture.

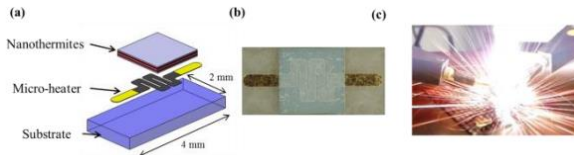

FIG. 5. (a) 3D schematic representation of a pyroMEMS; (b) photo of the pyroMEMS; (c) photo during the nanothermite reaction²⁷.

To ignite the pyroMEMS we designed a circuit (FIG. 6) based in a capacitive discharge (10 μ F). The PCB (55 mm \times 26 mm \times 1.6 mm) is powered by the 3 V from the fall detection PCB. In order to ensure the system's operation and security, some features have been implemented.

A converter (AP3015KTR-G1 from Diodes incorporated) is used to boost the voltage from 3 V to 24 V. This step is important to increase the value of the capacitor charger voltage. An energy of 1.25 mJ is necessary to ignite the pyroMEMS.

A linear programmable current source (LT3092 from Analog devices) is used for two routine: to verify if the pyroMEMS is connected, a small current (5 mA), and to charge the capacitor with constant current (200 mA).

A digital potentiometer (AD5160BRJZ50-RL7 from Analog devices) is used to set the current value. The device is programmed by the nRF52832 from the fall detection PCB via SPI.

We aim to charger the capacitor with a 16 V. The circuit takes 800 μ s to reach this value with 200 mA.

The ignition delay of the pyroMEMS is around 20 μ s, i.e., based on the lead time (259 ms) of the fall detection algorithm, the system has enough time to ensure the protection of the user. A 100% ignition is achieved with 10 μ F-16 V.

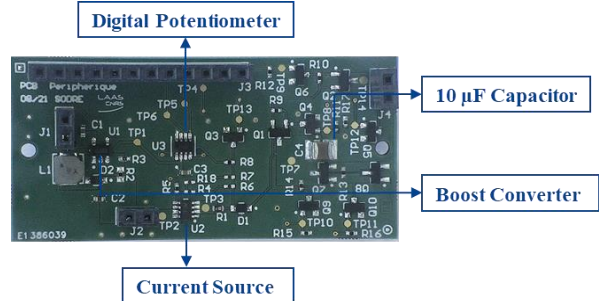

FIG. 6. Photo of the PCB used to ignite the pyroMEMS

IV. SYSTEM INTEGRATION

The system consists of the 3 PCBs presented above. The power connections between the PCBs are shown in FIG. 7. A support for the PCB that contains the pyroMEMS was produced in 3D printing to guarantee mechanical rigidity and sealing in the airbag.

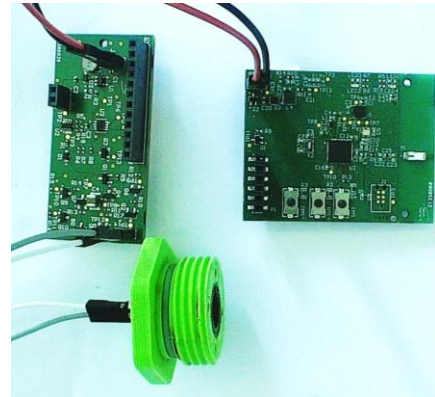

FIG. 7. Photo of the system without airbag

The full integration will be finished in the following months. A rigid-flex PCB is under development.

V. CONCLUSION

In this study, the feasibility of developing a light and small system for individual protection against falls was demonstrated. Based on the use of energetic composites, it is possible to generate an amount of gas to inflate the airbags.

The hardware and algorithm were designed to get a low power consumption, very high accuracy, and early pre-fall detection to trigger the safety devices, i.e., the wearable inflatable airbag.

Reference

- ¹ M.C. Nevitt, S.R. Cummings, and E.S. Hudes, *Journal of Gerontology* **46**, M164 (1991).
- ² R.W. Sattin, *Annual Review of Public Health* **13**, 489 (1992).
- ³ M.R. Kosorok, G.S. Omenn, P. Diehr, T.D. Koepsell, and D.L. Patrick, *Am J Public Health* **82**, 1263 (1992).
- ⁴ M.E. Tinetti, J. Doucette, E. Claus, and R. Marottoli, *Journal of the American Geriatrics Society* **43**, 1214 (1995).
- ⁵ R. Cuevas-Trisan, *Physical Medicine and Rehabilitation Clinics of North America* **28**, 727 (2017).
- ⁶ World Health Organization, editor, *WHO Global Report on Falls Prevention in Older Age* (World Health Organization, Geneva, Switzerland, 2008).
- ⁷ Y. Li, G. Chen, Y. Shen, Y. Zhu, and Z. Cheng, in *2012 IEEE 2nd International Conference on Cloud Computing and Intelligence Systems* (IEEE, Hangzhou, China, 2012), pp. 1216–1220.
- ⁸ J. Santiago, E. Cotto, L.G. Jaimes, and I. Vergara-Laurens, in *2017 IEEE 7th Annual Computing and Communication Workshop and Conference (CCWC)* (IEEE, Las Vegas, NV, USA, 2017), pp. 1–4.
- ⁹ M. Vallejo, C.V. Isaza, and J.D. Lopez, in *2013 35th Annual International Conference of the IEEE Engineering in Medicine and Biology Society (EMBC)* (IEEE, Osaka, 2013), pp. 1648–1651.
- ¹⁰ J. Dai, X. Bai, Z. Yang, Z. Shen, and D. Xuan, in *2010 8th IEEE International Conference on Pervasive Computing and Communications Workshops (PERCOM Workshops)* (2010), pp. 292–297.
- ¹¹ T. Tamura, M. Uchida, and O. Tanaka, *IEEE TRANSACTIONS ON INFORMATION TECHNOLOGY IN BIOMEDICINE* **13**, 5 (2009).
- ¹² G. Shi, C.S. Chan, W.J. Li, K.-S. Leung, Y. Zou, and Y. Jin, *IEEE Sensors J.* **9**, 495 (2009).
- ¹³ D. Oletic and V. Bilas, *Journal of Sensors* **2018**, 1 (2018).
- ¹⁴ F.A.S. Ferreira de Sousa, C. Escriba, E.G. Avina Bravo, V. Brossa, J.-Y. Fourniols, and C. Rossi, *IEEE Sensors J.* **22**, 1738 (2022).
- ¹⁵ L. Glavier, A. Nicollet, F. Jouot, B. Martin, J. Barberon, L. Renaud, and C. Rossi, *Prop., Explos., Pyrotech.* **42**, 308 (2017).
- ¹⁶ A. Nicollet, L. Salvagnac, V. Bajjot, A. Estève, and C. Rossi, *Sensors and Actuators A: Physical* **273**, 249 (2018).
- ¹⁷ T. Wu, G. Lahiner, C. Tenailleau, B. Reig, T. Hungria, A. Esteve, and C. Rossi, *Chemical Engineering Journal* **418**, 129432 (2021).
- ¹⁸ T.M. Southern and W.W. Wendlandt, *Journal of Inorganic and Nuclear Chemistry* **32**, 3783 (1970).
- ¹⁹ S. Mathew, C.G.R. Nair, and K.N. Ninan, *Bulletin of the Chemical Society of Japan* **64**, 3207 (1991).
- ²⁰ M. Künzel, J. Selesovsky, and R. Matyáš, *New Trends Res. Energ. Mater., Proc. Semin.* **18th** 664 (2015).
- ²¹ M. Künzel, O. Vodochodský, R. Matyáš, Z. Jalový, J. Pachman, and J. Maixner, *Cent. Eur. J. Energ. Mater.* **14**, 169 (2017).
- ²² T. Wu, F. Sevely, B. Julien, F. Sodre, J. Cure, C. Tenailleau, A. Esteve, and C. Rossi, *Combustion and Flame* **219**, 478 (2020).
- ²³ C. Rossi, *Prop., Explos., Pyrotech.* **44**, 94 (2019).
- ²⁴ L. Salvagnac, S. Assie-Souleille, and C. Rossi, *Nanomaterials* **10**, 2009 (2020).
- ²⁵ G. Taton, D. Lagrange, V. Conedera, L. Renaud, and C. Rossi, *J. Micromech. Microeng.* **23**, 105009 (2013).
- ²⁶ A. Nicollet, G. Lahiner, A. Belisario, S. Souleille, M. Djafari-Rouhani, A. Estève, and C. Rossi, *Journal of Applied Physics* **121**, 034503 (2017).
- ²⁷ A. Nicollet, F. Sevely, S. Vivies, L. Salvagnac, and C. Rossi, in (2019).