



**HAL**  
open science

## Battery-free, Wirelessly Powered and Controlled Concrete Resistivity Sensing Node

Gaël Loubet, Alassane Sidibe, Alexandru Takacs, Jean-Paul Balayssac,  
Daniela Dragomirescu

► **To cite this version:**

Gaël Loubet, Alassane Sidibe, Alexandru Takacs, Jean-Paul Balayssac, Daniela Dragomirescu. Battery-free, Wirelessly Powered and Controlled Concrete Resistivity Sensing Node. 2022 IEEE Wireless Power Transfer Conference (WPTC), Jul 2022, Bordeaux, France. 10.1109/WPW54272.2022.9853942 . hal-03648926

**HAL Id: hal-03648926**

**<https://laas.hal.science/hal-03648926>**

Submitted on 22 Apr 2022

**HAL** is a multi-disciplinary open access archive for the deposit and dissemination of scientific research documents, whether they are published or not. The documents may come from teaching and research institutions in France or abroad, or from public or private research centers.

L'archive ouverte pluridisciplinaire **HAL**, est destinée au dépôt et à la diffusion de documents scientifiques de niveau recherche, publiés ou non, émanant des établissements d'enseignement et de recherche français ou étrangers, des laboratoires publics ou privés.

# Battery-free, Wirelessly Powered and Controlled Concrete Resistivity Sensing Node

Gaël LOUBET  
LAAS-CNRS

Université de Toulouse, CNRS, INSA  
Toulouse, FRANCE  
gael.loubet@laas.fr  
0000-0003-3347-0036

Alassane SIDIBE  
LAAS-CNRS, UWINLOC  
Université de Toulouse, CNRS  
Toulouse, FRANCE  
alassane.sidibe@laas.fr  
0000-0003-4123-7349

Alexandru TAKACS  
LAAS-CNRS  
Université de Toulouse, CNRS, UPS  
Toulouse, FRANCE  
alexandru.takacs@laas.fr  
0000-0001-5485-7817

Jean-Paul BALAYSSAC  
LMDC

Université de Toulouse, UPS  
Toulouse, FRANCE  
jean-paul.balayssac@insa-toulouse.fr  
0000-0003-3965-4709

Daniela DRAGOMIRESCU  
LAAS-CNRS  
Université de Toulouse, CNRS, INSA  
Toulouse, FRANCE  
daniela.dragomirescu@laas.fr  
0000-0001-8589-6093

**Abstract**—This paper presents a generic Sensing Node, part of a Cyber-Physical System, dedicated to the Structural Health Monitoring of reinforced concretes. The Sensing Node is: battery-free; low-power; fully wireless; wirelessly, remotely and omnidirectionally powered and controlled by the Communicating Node(s) over several meters (at least 11 meters in indoor). It can be buried in the reinforced concrete and measure relevant parameters, such as temperature, relative humidity, mechanical deformation, and electrical resistivity to estimate the corrosion rate. By using a unique antenna, the proposed solution meets the requirements of the Simultaneous Wireless Information and Power Transfer paradigm. The proposed system is easily scalable to other applications, especially in harsh environments.

**Keywords**—Wireless Power Transmission (WPT), Wireless Sensor Networks (WSN), Cyber-Physical Systems (CPS), Internet of Things (IoT), Simultaneous Wireless Information and Power Transfer (SWIPT), Structural Health Monitoring (SHM), Non-Destructive Testing (NDT).

## I. INTRODUCTION

With the digitalisation and miniaturisation of electronics, embedded systems are always more effective and pervasive. This is particularly true with those able to communicate wirelessly with humans and/or machines, and which have enabled the development of the Wireless Sensor Networks (WSN). These can be employed to monitor and/or control the physical world, as well as to connect the physical and digital worlds in Cyber-Physical Systems (CPS), such as the Internet of Things (IoT). Currently, the long-term deployment of WSN is mainly restricted by their energy autonomy. To lengthen their limited lifespan, ambient energy harvesting and Wireless Power Transmission (WPT) solutions are investigated to power them [1]. By considering both the electromagnetic WPT and the wireless communication, the WSN meets of the Simultaneous Wireless Information and Power Transfer (SWIPT) paradigm [2].

At the same time, the Structural Health Monitoring (SHM) is always more common in all application fields, especially in the civil engineering industry. It consists of “permanent” overseeing of the health of an object, to prevent its irreversible failures, avoid its collapse, and allow preventive treatments to be applied. For this, Non-Destructive Testing (NDT) methods are preferred because these do not alter the element under test.

This research has been funded by the French National Research Agency (ANR) under the McBIM project, grant number ANR-17-CE10-0014.

In this context, the McBIM project (Material communicating with the BIM (Building Information Modelling)) [3] aims to propose an implementation of the concept of communicating materials [4] in the case of reinforced concrete, in part to ensure the SHM of reinforced concrete structures thanks to NDT methods [5,6].

In this paper, a fully wireless, battery-free, wirelessly powered and controlled Sensing Node (SN) is presented. This employs diverse sensors including an electrical resistivity sensor to ensure the SHM of reinforced concrete. Next, the architecture and implementation of the SN, as well as of the CPS of which it is a part, will be presented. Then, some experimental results achieved to date will be explicated. Before the conclusion, the current and future works, as well as the contributions of this research will be discussed.

## II. DESIGN OF THE CYBER-PHYSICAL SYSTEM AND OF THE SENSING NODE

Embedding a WSN in the reinforced concrete has been decided for the implementation of the communicating reinforced concrete [3,7,8]. This must last decades and be intrinsically able to: (1) generate (locally); (2) store (locally and/or remotely); (3) process (locally and/or remotely); and (4) share data (from its own health and/or environment) with other communicating elements (in the physical world) and with a digital twin (such as a BIM) through the Internet (in the digital world), in order to keep an up-to-date model of the element, for which the current and past information are easily accessible for the different stakeholders. It also is a full CPS.

### A. Architecture of the Cyber-Physical System

The architecture of the designed CPS is presented in Fig. 1 and in [7,8]. The WSN is composed of two kinds of nodes: the Sensing Nodes (SN) and the Communicating Nodes (CN). The SN sense the target parameters, format the measured data and send these wirelessly to the CN. The CN gather the data sent by the SN, process, store and exchange these with other CN composing an *ad-hoc* mesh network, eventually with other communicating elements, and with the digital world and its virtual models *via* the Internet. Moreover, the CN power wirelessly the SN thanks to a radiative electromagnetic WPT system, thus, in far-field. The number of embedded SN and CN is a function of the size of the element to monitor and of its need in terms of measurements (*e.g.* kinds of sensor, spatial precision, etc.).

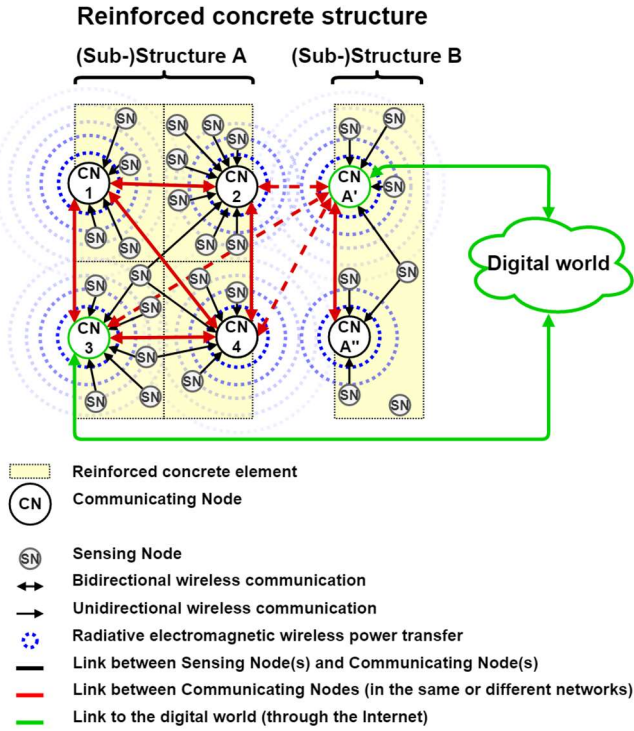

Fig. 1. Block diagram of the architecture of the cyber-physical system.

### B. Architecture and Implementation of the Sensing Node

The architecture of the designed SN is presented in Fig. 2 and in [7,8]. These SN have been well optimized especially in terms of durations of charges, and of minimum input power, directly linked to the range of use. These become inaccessible once deployed and buried in reinforced concrete, and thus, must be reliable and usable for decades. That is why these are as simple as possible, fully wireless, battery-free, wirelessly powered and controlled. The SN is composed of two subsystems, for the management of: the data and the power.

The data management subsystem consists of a sensor, a microcontroller unit and a LoRa transceiver. Several sensors dedicated to the SHM of reinforced concrete according to [6] have already been implemented [7]: a temperature sensor based on thermodiodes from the University of Cambridge [9]; a Texas Instruments HDC2010 temperature and humidity sensor; a strain gauge; and an electrical resistivity sensor in Wenner configuration, as presented in Fig. 3, provided by the LMDC of Toulouse [10]. According to [5,10,11], the measurement of the electrical resistivity of reinforced concrete is correlated to several parameters, particularly its evolution allows to estimate the corrosion rate. A Murata CMWX1ZZABZ-091 all-in-one LoRaWAN module is used to format on 4 bytes and transmit wirelessly the collected data via a 17 bytes-long LoRaWAN frame, with a transmission power of +4 dBm and a data-rate of 5470 bps, to the CN. The LoRaWAN technology in the ISM 868 MHz frequency band has been chosen for the communication from the SN to the CN because of its low power consumption and its ability to work unidirectionally over long ranges, even indoors, and from and through reinforced concrete which appears as a very constraining propagation medium for electromagnetic waves.

The power management subsystem consists of a RF-to-DC rectifier, a power management unit (PMU), and an energy buffer [7]. As ambient energy sources are unavailable or insufficient, unpredictable, uncontrollable and fluctuating

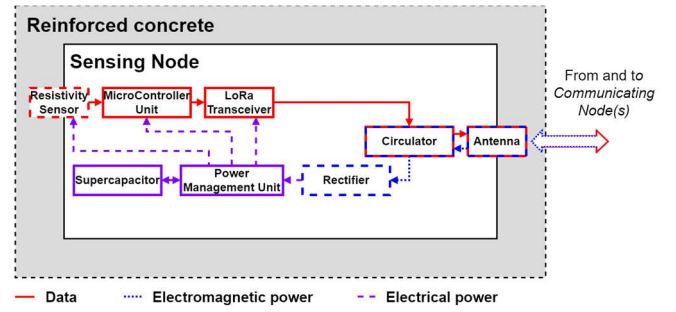

Fig. 2. Block diagram of the architecture of the Sensing Node dedicated to the measurement of the electrical resistivity of concrete.

inside reinforced concrete, the WPT seems more relevant for powering the SN. To get ranges of use of several meters, radiative (far-field) solutions have been favoured over the near-field (capacitive and inductive) ones. Moreover, the ISM 868 MHz frequency band has been chosen as the best trade-off between the antenna size and the propagation losses. Thus, to wirelessly power the SN, the CN use a RF power source providing a +33 dBm EIRP continuous wave (CW) in the ISM 868 MHz frequency band [12]. So on, a doubler rectifier based on Skyworks SMS7630 Schottky diodes has been used to collect the RF power transmitted by the CN and to convert it into DC power. Texas Instruments bq25504 PMU and TPS63031 DC-to-DC buck-boost converter have been employed to store the scavenged energy in a 2.2 mF Panasonic polarized aluminium electrolytic supercapacitor, and to provide a 3.3 V power supply to the data management subsystem each time that enough stored energy is available.

As the same ISM frequency band is used both for the wireless communication and the WPT, a unique printed folded quart-wavelength dipole antenna with capacitive arms with a gain of +1.54 dBi [13] and a radiofrequency circulator with low insertion losses and high isolations have been used. Thus, this antenna is connected to the RF-to-DC rectifier to form a rectenna, and the transceiver to the antenna to allow the wireless communication. The requirements of the SWIPT paradigm are met with only a multiplexing per function.

Moreover, as the SN are both hardware and software inaccessible (no physical access and no data downlink) and since the periodicity of measurement in function of the step in

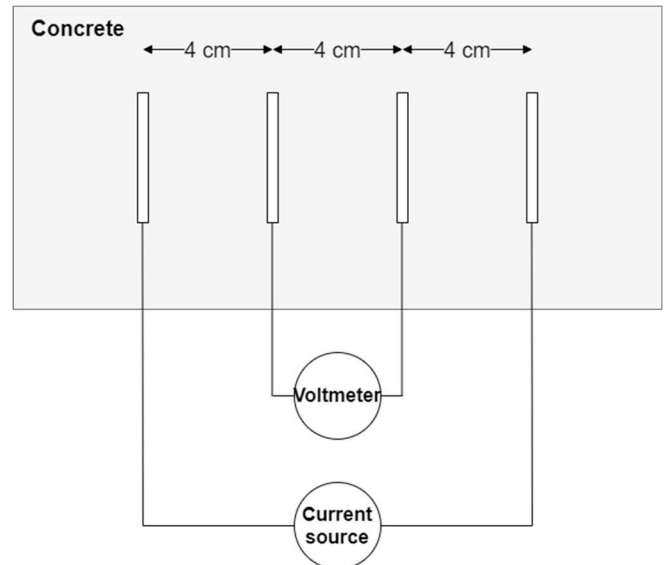

Fig. 3. Diagram of the geometry of the Wenner probe buried in concrete.

the lifecycle, these are controlled wirelessly and remotely by the CN through the power downlink *via* the tuning of the WPT system (e.g. in terms of waveform, output power and/or periodicity of activation/duty cycle).

A complete SN is presented in Fig. 4, where it is connected to a resistivity sensor embedded in a sample of concrete. It must be noted that the resistivity sensor (*i.e.* the probes in Wenner configuration) is fully buried in a concrete sample, whilst the full SN are not yet packaged (*cf.* Discussion) and are only embedded in air cavities of a reinforced concrete beam during experimentations (*cf.* Fig. 7). In addition, due to manufacturing and testing constraints, the resistivity measurements are not performed in the same reinforced concrete sample as in which the SN are embedded (*cf.* Fig. 7).

### III. EXPERIMENTAL RESULTS

In the less reliable configuration (noted *Conf. 1*) allowed by the LoRaWAN module for the wireless communication (*Conf. 1*: lowest transmission power (+4 dBm) and fastest data-rate (5470 bps)), the SN must store 21 mJ of energy (or 5.25 mJ per data byte or 309 mJ per transmitted byte, or 39  $\mu$ J per transmitted bit) to achieve a full process: the measurement regardless of the sensor used, and the complete transmission of a 17 bytes long LoRaWAN frame with 4 bytes of data payload. The *Conf. 1* allows wireless communication from a reinforced concrete beam over at least a few tens of meters. In a more reliable configuration (noted *Conf. 2*) allowing wider ranges (*Conf. 2*: highest transmission power (+14 dBm) and slowest data-rate (250 bps)) 250 mJ of energy must be stored (or 62.5 mJ per data byte or 14.71 mJ per transmitted byte, or

1.84 mJ per transmitted bit). These amounts of energy are an overestimation of +20 % of the average needs, to certify a proper functioning despite the variability of the components and their aging. As the data management subsystem impacts the design of the power management subsystem, this last must be adapted to the energy needs. For the *Conf. 2*, the capacitance must be increased to 22 mF and the PMU activation and deactivation threshold voltages must be tuned.

The duration of the first charge (from an empty energy buffer) and of the recharges (after another full charge) gives a relevant information concerning the smallest periodicity of the functioning of the SN in function of the amount of power at its input (which can be seen as a function of the distance to the power source controlled by a CN) and of the amount of energy to store (which can be seen here as a function of the performances of the wireless communication). Thus, as presented in Fig. 5, in *Conf.1* the SN can work with -17 dBm of power provided by the antenna to the radiofrequency circulator and at least up to +15 dBm. The first charge lasts respectively between around 17 hours and 21 minutes (for a -17 dBm input power), and around 30 seconds (for a +15 dBm input power), while the recharges between 7 hours and 59 minutes (for a -17 dBm input power), and around 6 seconds (for a +15 dBm input power). For the *Conf. 2*, the minimum input power is -14 dBm, and the first charge lasts respectively between around 34 hours and 36 minutes (for a -14 dBm input power), and around 1 minute and 10 seconds (for a +15 dBm input power), while the recharges between 14 hours and 38 minutes (for a -14 dBm input power), and around 33 seconds (for a +15 dBm input power). Longer periodicities can be obtained by controlling the duration and periodicity of activation of the power source by the CN.

According to the needs in terms of periodicity of measures, a minimum input power must be considered. By applying the Friis equation, the distance between the +33 dBm EIRP power source at 868 MHz and the +1.54 dBi antenna of the SN can be estimated in function of the targeted input power. Thus, -14 dBm are available at a distance of nearly 7.35 m (*i.e.* a periodicity of about 57 minutes and about 14 hours and 38 minutes, respectively for *Conf. 1* and *Conf. 2*) and -17 dBm at nearly 10.38 m (*i.e.* a periodicity of about 7 hours and 59 minutes for *Conf. 1*), and nearly -10.6 dBm can be harvested at 5 m (*i.e.* a periodicity of about 15 minutes and about 3 hours, respectively for *Conf. 1* and *Conf. 2*). By adopting another trade-off between performance and size for the antenna, especially by increasing the gain, wider ranges can be obtained. By adding an 8 cm x 6 cm metallic reflector plane 5 cm behind the antenna, its gain is increased up to +5.00 dBi. In this case, -14 dBm are available at a distance of nearly 10.95 m and -17 dBm at nearly 13.78 m, and nearly -7.2 dBm (*i.e.* a periodicity of about 6 minutes and about 50 minutes, respectively for *Conf. 1* and *Conf. 2*) can be harvested at 5 m.

Therefore, by minimizing the power needed by the power management subsystem (to power the PMU and compensate the losses of the converter and energy buffer), the range of use can be increased. In addition, by minimizing the energy needed by the data management subsystem, the duration of the first charge and recharges can be reduced. Nevertheless, the distance between CN and SN is limited by the WPT and its regulations [12], and not by the wireless communication.

To quantify the corrosion rate of the reinforced concrete, the evolution of its electrical resistivity measurements can be performed [11]. Thus, this is the evolution and not the value

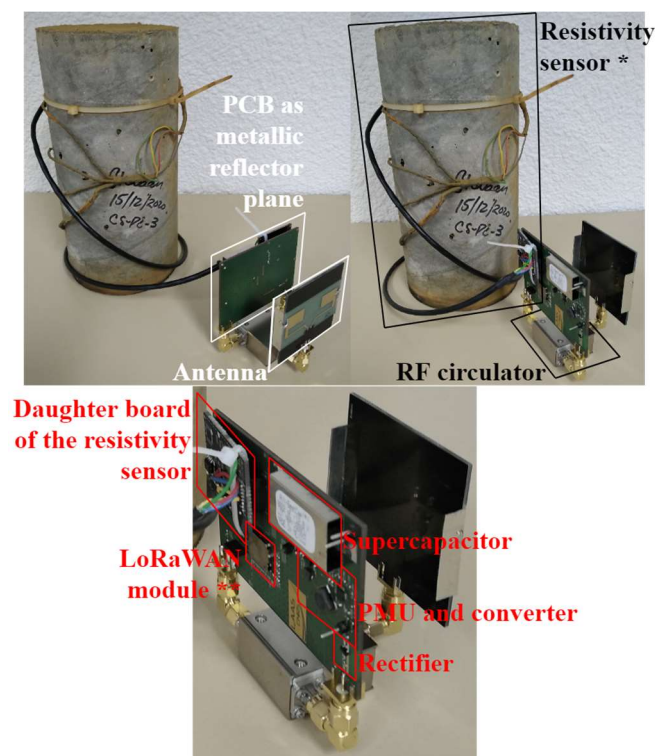

\* Wenner probe buried in a concrete sample and a daughter board connected to the Sensing Node

\*\* Microcontroller Unit and LoRa transceiver

Fig. 4. Photograph of a Sensing Node with a resistivity sensor buried in a concrete sample.

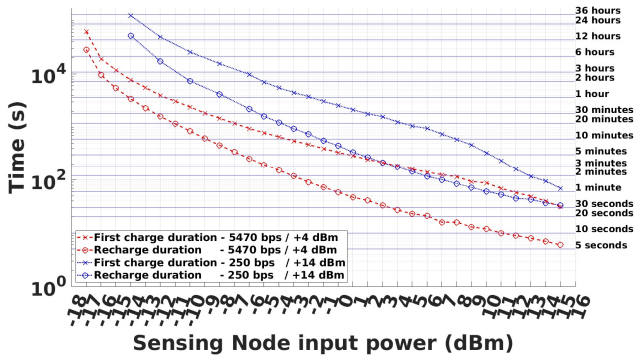

Fig. 5. Durations of the first charge (‘x’) and recharges (‘o’) against the electromagnetic power applied at the input of the circulator of the Sensing Node, at 868 MHz, and for two configurations of the wireless communication: *Conf.1* (transmission power of +4 dBm and data rate of 5470 bps) (red, dashed lines), and *Conf.2* (transmission power of +14 dBm and data rate of 250 bps) (blue, dotted lines).

itself which is significant. Here, as presented in Fig. 3 and Fig. 4, 4 metallic probes spaced 4 cm ( $d$ ) apart are buried in a concrete sample to be used in a Wenner configuration: the external probes are connected to a 100  $\mu$ A current source to generate a direct current through the concrete ( $I$ ), and a potentials difference ( $U$ ) is measured between the internal probes to compute the electric resistance ( $R$ ) by the Ohm’s law. By considering the sample as quasi-infinite and the current flow homogeneous between the probes, (1) allows to estimate the resistivity ( $\rho$ ).

$$\rho = 2 \pi d R = 2 \pi d U / I \quad (\Omega \cdot \text{m}) \quad (1)$$

Here, the range of resistivity is between 0  $\Omega \cdot \text{m}$  and more than 5  $\text{k}\Omega \cdot \text{m}$ , with a step of around 2  $\Omega \cdot \text{m}$ . The proposed implementation is low-power: 580  $\mu$ W are required in stand-by mode for a 3.3 V supply; and allows to wirelessly transmit the collected data. To certify its good design and implementation, a large amount of punctual and comparative measurements has been carried out with, on one hand, laboratory equipment to power the daughter board and measure the output voltage, and, on other hand, with a SN, both in similar configurations: with a water saturated concrete sample (as soon as it comes out of the water where it was stored during several days) and during its first hours of drying. Thus, the measurement reproducibility has been checked. Also, to certify the long-term reliability, a long duration experiment has been successfully performed during 58 day (from the 12<sup>th</sup> of May, 2021, to the 7<sup>th</sup> of July, 2021) in Toulouse (FRANCE), as presented in Fig. 6. This has allowed to check the evolution of the resistivity during the drying of a water saturated concrete sample (as soon as it comes out of the water where it was stored during several days), and to correlate this last with the temperature and relative humidity measurements got in the same place. Thus, a SN powered with a -8 dBm CW has measured the resistivity (almost each 2 hours 30 minutes), whilst another powered with a -6 dBm CW has measured the temperature and relative humidity (almost each hour and 15 minutes). It must be noted that these two SN have been employed before the last optimizations regarding the minimization of the duration of the charges. As presented in Fig. 6, the overall behaviour is in line with expectations: (1) during the first hours, the resistivity increases quickly as the concrete sample dries quickly; (2) then, the resistivity increases slowly and tends to stabilize. Three particular kinds

of events can also be analysed: (1) during a period of heavy rainfall, the relative humidity increases and the resistivity decreases as the water content of the concrete sample increases; (2) with the use of a fan heater, the temperature increases sharply, as well as the relative humidity decreases sharply, and the resistivity drops quickly, but by turning off the fan heater, the return to the previous state is fast. Thus, a significant change in the environment or in the internal properties of the concrete can be detected by this resistivity sensor and can be defined as temporary or permanent; and (3) a poor connection of the daughter board of the sensor to the SN has been observed. This one arrived just after the first use of the fan heater (maybe induced by the expansion of the pin-header) and has been solved by the reconnection of the daughter board a few days later. Nevertheless, the rapid drop in resistivity at the disconnection and the rapid rise at the reconnection could be explained respectively by the polarization and depolarization of the concrete induced by current losses during this period. Further experimentations must be performed to confirm these hypotheses.

Some qualitative tests have been performed to certify the proper functioning of the SN and of the CPS [7,8]. For instance, a CPS composed of a mesh network of 2 CN (one with a connection to the Internet) and 4 SN, where 3 are located in air cavities of a reinforced concrete beam, as presented in Fig. 7, has been successfully tested. The CN wirelessly powered and controlled the SN (even embedded in reinforced concrete) over meters (at least 3 meters, with at least 15 cm of reinforced concrete), and all the data sent by the SN have been collected (at least, at a few tens of meters), processed, stored and shared by the CN. Obviously, a unique CN can easily manage several SN omnidirectionally over several metres. Indoors, a distance of 11 meters has successfully been tested between CN and SN. Nevertheless, it seems possible to achieve wider ranges.

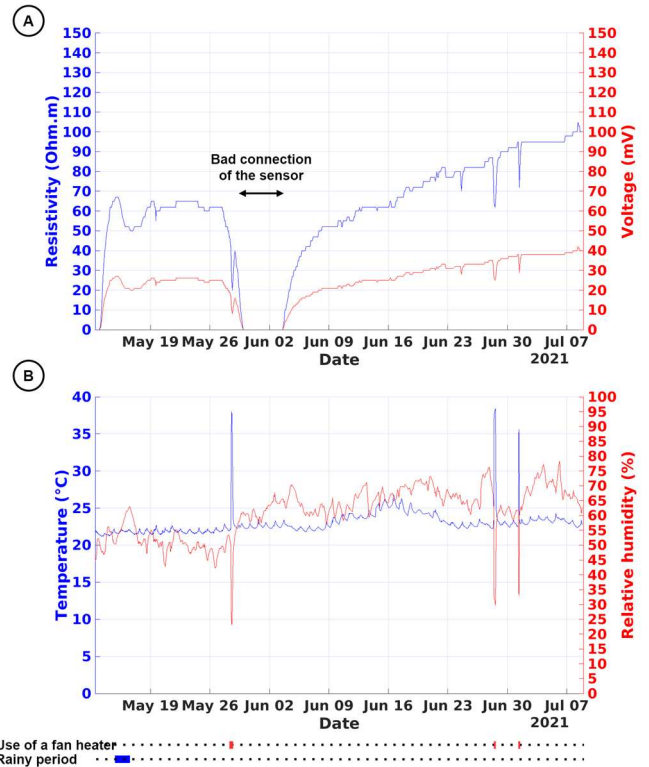

Fig. 6. Evolutions over several days (A) of the computed resistivity and of the measured output voltage of the resistivity sensor, and (B) of the temperature and relative humidity, during the drying of a concrete sample.

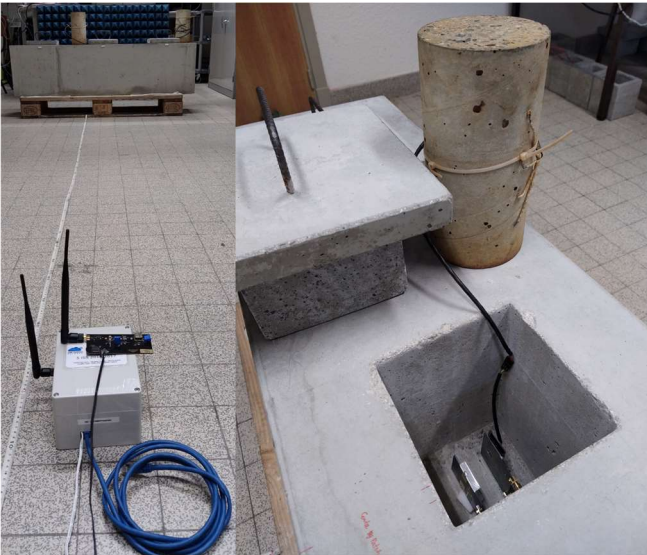

Fig. 7. Photographs of the test of a CPS with 3 SN embedded into a reinforced concrete beam, and wirelessly powered and controlled by a CN.

#### IV. DISCUSSION

From our previous works [7,8], some improvements have been achieved, especially regarding the duration of the charges and the minimum required input power (optimized from -14 dBm to -17 dBm), as presented in Fig. 5, and in the integration of sensors. Also, a particular interest has been shown in the measurement of resistivity, a physical value of interest for reinforced concretes. Currently, there is no available low-power, battery-free, fully wireless, and fully buried SN, or WSN, dedicated to the SHM of reinforced concrete, especially able to estimate its corrosion rate. Indeed, the available ones are usually placed on the surface and have a limited life due to the use of batteries. Concerning the corrosion sensors for the reinforced concretes, few are based on the manual measurement of the surface electrical resistivity [14,15]; others are buried in the near surface and are automatically driven by a datalogger [16]; while [17] presents a passive sensor, which can be locally interrogated by a magnetic field. Finally, [18] provides an electrical resistivity sensor fully buried in reinforced concrete, but which is not yet able to wirelessly transmit the collected data, and which is not energy autonomous. Thus, to our best knowledge, the first generic SN dedicated to the SHM of concrete, which is fully buried, fully wireless, low-power, battery-free, wirelessly powered and controlled, and part of a CPS that can automate the monitoring, is proposed here.

However, this one may be improved both for the data and power management subsystems. The power required by the PMU may be reduced, as well as the losses of the converter and of the energy buffer, in order to increase the range of use. Also, the energy required by the active components may be minimized, in order to reduce the duration of the first charge and recharges. The sensors may be optimized to be more accurate and to consume less power. In addition, the resistivity sensor may be improved by using an alternative current source to limit the concrete polarization, and configurations other than the Wenner could be implemented [10]. Moreover, the efficiency of the WPT system may be optimized by using a more efficient rectenna (antenna and rectifier), or by focusing the transmitted power on the SN with beamforming or Frequency-Diverse Arrays (FDA) techniques. Nevertheless,

the proposed solution can easily be scalable to other applications and is in the state-of-the-art of WSN powered by WPT. Indeed, there are few commercially available solutions of radiative WPT to try to recharge the battery of devices or increase their discharge time, and these are limited in terms of distance and of efficiency [19,20]. As well, a few academic works or start-up companies propose battery-free and wirelessly powered SN, which use radiative WPT (respecting the regional regulations, here: [12]) and wireless communication technologies for IoT [21-27]. These latter meet the requirements of the SWIPT paradigm, thanks to frequency and/or spatial multiplexing. These use usually a “direct consumption” strategy (the input power is at least equal to the required power to supply the SN), with software-controlled periodicity and alternating between sleep and standby modes. Thus, their range of use is generally limited to a few meters. Only [24] provides a higher theoretical range of use (16.8 meters) but by using a commercially unavailable PMU and without testing it. Thus, 11 meters is the longest range of use of a tested SN wirelessly powered by radiative WPT, to the best of our knowledge. Nevertheless, by optimizing the proposed solution, wider ranges of use seem to be reachable. In addition, -17 dBm as minimum input power is the lowest found in the literature, to the best of our knowledge, although a PMU is defined to work from an input power of -18.5 dBm in the ISM 868 MHz frequency band [28].

Finally, the packaging question must be answered to deploy the SN directly in the reinforced concrete (no more in air cavities) and by making possible reliable measurements in it [29]. To finish, the antenna must be tuned to efficiently operate in the direct contact of the concrete both for the WPT and the wireless communication [30].

#### V. CONCLUSION

This paper presents a generic battery-free wireless SN dedicated to the SHM of reinforced concrete in which it is fully buried. The SN are wirelessly and remotely powered and controlled by the CN over several meters and use a unique antenna to implement the SWIPT paradigm. Experimental results demonstrated that the range for the WPT is at least 11 meters in indoor conditions at 868 MHz, while the range for the wireless communication can reach hundreds of meters thanks to the adopted LoRaWAN solution. The successfully tested CPS allows to measure and share data, especially related to the corrosion, from the reinforced concrete to the Internet.

#### ACKNOWLEDGMENT

The authors would like to thank all their partners in the McBIM project: CRAN (Nancy), LIB (Dijon), and FINAO SAS / 360SmartConnect (Trans-en-Provence).

#### REFERENCES

- [1] G. Peruzzi, and A. Pozzebon, “A review of energy harvesting techniques for Low Power Wide Area Networks (LPWANs),” *Energies*, vol. 13, n° 13, p. 3433, 2020.
- [2] T.D. Ponnimbaduge Perera, D.N.K. Jayakody, S.K. Sharma, S. Chatzinotas, and J. Li, “Simultaneous wireless information and power transfer (SWIPT): Recent advances and future challenges,” *IEEE Commun. Surveys Tuts*, vol. 20, no. 1, pp. 264–302, 2018.
- [3] W. Derigent, and al., “Materials communicating with the BIM: results of the McBIM project,” 13th International Workshop on Structural Health Monitoring (IWSHM), 2022, in press.
- [4] S. Kubler, W. Derigent, A. Thomas, and E. Rondeau, “Problem definition methodology for the “Communicating Material” paradigm,” *IFAC Proceedings Volumes*, vol. 43, no. 4, pp. 198-203, 2010.

- [5] D. Darwin, C.W. Dolan, and A.H. Nilson, "Design of concrete structures," 15<sup>th</sup> Ed., New York, NY, USA, McGraw-Hill Education, 2016.
- [6] S. Taheri, "A review on five key sensors for monitoring of concrete structures," *Construction and Building Materials*, vol. 204, pp. 492-509, 2019.
- [7] G. Loubet, "Autonomous wireless sensor networks for the implementation of communicating materials. Application to civil engineering industry,," Doctoral dissertation, INSA Toulouse, 2021.
- [8] G. Loubet, A. Takacs, and D. Dragomirescu, "Implementation of a Wireless Sensor Network Designed to be Embedded in Reinforced Concrete," 46th Annual Conference of the IEEE Industrial Electronics Society, IECON 2020, pp. 2195-2200, 2020.
- [9] A. De Luca, V. Pathirana, S.Z. Ali, D. Dragomirescu, and F. Udrea, "Experimental, analytical and numerical investigation of non-linearity of SOI diode temperature sensors at extreme temperatures," *Sensors and Actuators A: Physical*, vol. 222, pp. 31-38, 2015.
- [10] J. Badr, "Conception et validation d'un capteur noyé de résistivité électrique en vue du suivi des profils de teneur en eau dans les bétons," Doctoral dissertation, Université Paul Sabatier-Toulouse III, 2019.
- [11] P. Azarsa, and R. Gupta, "Electrical resistivity of concrete for durability evaluation: a review," *Advances in Materials Science and Engineering*, 2017.
- [12] European Union, "COMMISSION IMPLEMENTING DECISION (EU) 2017/1483 of 8 August 2017 amending Decision 2006/771/EC on harmonisation of the radio spectrum for use by short-range devices and repealing Decision 2006/804/EC," *Official Journal of the European Union*, Decision C(2017) 5464, 2017.
- [13] A. Sidibe, A. Takacs, G. Loubet, and D. Dragomirescu, "Compact Antenna in 3D Configuration for Rectenna Wireless power transfer Applications," *Sensors*, vol. 21, no. 9, p. 3193, 2021.
- [14] "GIATEC - iCOR® Wireless NDT Corrosion Detection" Available online: <https://www.giatecscientific.com/products/concrete-ndt-devices/icor-rebar-corrosion-rate/> (accessed on 2 February 2022).
- [15] "Screening Eagle - Proceq Resipod" Available online: <https://www.screeningeagle.com/en/products/resipod> (accessed on 2 February 2022).
- [16] "CEMENTYS - CorroVolta® Corrosion sensor," Available online: <https://cementys.com/en/corrosion-sensor-monitoring-corrovolta/> (accessed on 2 February 2022).
- [17] M.M. Andringa, D.P. Neikirk, N.P. Dickerson, and S.L. Wood, "Unpowered wireless corrosion sensor for steel reinforced concrete," in *SENSORS 2005*, IEEE, p. 4, November 2005.
- [18] D.M. Corva, S.S. Hosseini, F. Collins, S.D. Adams, W.P. Gates, and A.Z. Kouzani, "Miniature resistance measurement device for structural health monitoring of reinforced concrete infrastructure," *Sensors*, vol. 20, no. 15, p. 4313, 2020.
- [19] "Powercast - Wireless power for a wireless world" Available online: <https://www.powercastco.com/> (accessed on 2 February 2022).
- [20] "Ossia" Accessed: Available online: <https://www.ossia.com/> (accessed on 2 February 2022).
- [21] K. M. Farinholt, G. Park, and C. R. Farrar, "RF energy transmission for a low-power wireless impedance sensor node," *IEEE Sensors Journal*, vol. 9, no. 7, pp. 793-800, 2009.
- [22] J. Janhunen, K. Mikhaylov, and J. Petäjälä, "Experimental RF-signal based wireless energy transmission," in *EuCNC The IEEE European Conference on Networks and Communications*, pp. 1-6, 2017.
- [23] J. Janhunen, K. Mikhaylov, J. Petäjälä, and M. Sonkki, "Wireless energy transfer powered wireless sensor node for green IoT: Design, implementation and evaluation," *Sensors*, vol. 19, no. 1, p. 90, 2019.
- [24] M. Pizzotti, L. Perilli, M. Del Prete, D. Fabbri, R. Canegallo, M. Dini, D. Masotti, A. Costanzo, E. Franchi Scarselli, and A. Romani, "A long-distance RF-powered sensor node with adaptive power management for IoT applications," *Sensors*, vol. 17, no. 8, p. 1732, 2017.
- [25] R. La Rosa, C. Trigona, G. Zoppi, C. A. Di Carlo, L. Di Donato, and G. Sorbello, "RF energy scavenger for battery-free Wireless Sensor Nodes," in *I2MTC The IEEE International Instrumentation and Measurement Technology Conference*, pp. 1-5, 2018.
- [26] G. Paolini, D. Masotti, M. Guermanni, M. Shanawani, L. Benini, and A. Costanzo, "An Ambient-Insensitive Battery-Less Wireless Node for Simultaneous Powering and Communication," in *EuMC The 50th IEEE European Microwave Conference*, pp. 522-525, 2021.
- [27] "GreenWake Technologies - Remote powering of sensors - no wires, no batteries, no worries" Available online: <http://gnw-tech.com/home.htm> (accessed on 2 February 2022).
- [28] "e-peas semiconductors - AEM30940 - datasheet" Available online: <https://e-peas.com/wp-content/uploads/2021/03/e-peas-AEM30940-datasheet-RF-Vibration-energy-harvesting.pdf> (accessed on 2 February 2022).
- [29] G. Castorina, L. Di Donato, A.F. Morabito, T. Isernia, G. and Sorbello, "Analysis and design of a concrete embedded antenna for wireless monitoring applications [antenna applications corner]," *IEEE Antennas and Propagation Magazine*, vol. 58, no. 6, pp. 76-93, 2016.
- [30] E. Fraile-Garcia, J. Ferreiro-Cabello, E.M. de Pison Ascacibar, J.F. Ceniceros, and A.V.P. Espinoza, "Implementing a technically and economically viable system for recording data inside concrete," *Construction and Building Materials*, vol. 157, pp. 860-872, 2017.