



HAL
open science

GaAs membrane PhC lasers threshold reduction using AlGaAs barriers and improved processing

Sergio Iván Flores Esparza, Aurélie Lecestre, Pascal Dubreuil, Alexandre Arnoult, Adnen Mlayah, Antoine Monmayrant, Olivier Gauthier-Lafaye

► To cite this version:

Sergio Iván Flores Esparza, Aurélie Lecestre, Pascal Dubreuil, Alexandre Arnoult, Adnen Mlayah, et al.. GaAs membrane PhC lasers threshold reduction using AlGaAs barriers and improved processing. *Nanotechnology*, 2022, 34 (1), pp.015303. <10.1088/1361-6528/ac9685>. <hal-03812858>

HAL Id: hal-03812858

<https://laas.hal.science/hal-03812858v1>

Submitted on 13 Oct 2022

HAL is a multi-disciplinary open access archive for the deposit and dissemination of scientific research documents, whether they are published or not. The documents may come from teaching and research institutions in France or abroad, or from public or private research centers.

L'archive ouverte pluridisciplinaire **HAL**, est destinée au dépôt et à la diffusion de documents scientifiques de niveau recherche, publiés ou non, émanant des établissements d'enseignement et de recherche français ou étrangers, des laboratoires publics ou privés.



HAL Authorization

GaAs membrane PhC lasers threshold reduction using AlGaAs barriers and improved processing

Sergio Iván Flores Esparza, Aurélie Lecestre, Pascal Dubreuil, Alexandre Arnoult, Adnen Mlayah, Antoine Monmayrant, and Olivier Gauthier-Lafaye

LAAS-CNRS, Université de Toulouse, CNRS, 7 Avenue du Colonel Roche, 31400 Toulouse, France

E-mail: olivier.gauthier-lafaye@laas.fr

May 2022

Abstract. Active suspended membranes are an ideal test-bench for experimenting with novel laser geometries and principles. We show that adding thin AlGaAs barrier near the top and bottom Air/GaAs interfaces of the membrane significantly reduces the carriers non-radiative recombinations and decreases the threshold of test photonic crystal test lasers. We review the existing literature on photonic crystal membrane fabrication and propose an overview of the significant defects that can be induced by each fabrication step. Finally we propose a complete processing scheme that overcome most of these defects.

Submitted to: *Nanotechnology*

1. Introduction

2D Photonic Crystal (PhC) are particularly successful to study light-matter interaction [1, 2, 3, 4, 5, 6], induce non-linear light conversion [7, 8, 9] and to serve as extremely compact laser sources [10, 11, 12, 13, 14]. In particular, active suspended membranes are an ideal test-bench for experimenting with novel laser geometries and principles, such as chemical and biological sensors [15, 16], logic gates for photonic computation [17].

GaAs based photonic crystal membranes fabrication have been an active field of research for several years. In particular they have been used for PhC lasers and passive devices demonstrations, and are particularly attractive for Near InfraRed (NIR) active devices as efficient InGaAs Quantum Wells (QWs) or Quantum Dots (QDs). Their development has been hindered as compared to InP based lasers mostly due to the highly effective non radiative recombination rates of GaAs surfaces [18, 19], which strongly limits their practical implementation.

33 In this paper, we show that PhC lasers threshold can be drastically reduced by
 34 using a combination of first AlGaAs barriers that prevent carriers diffusion to the
 35 GaAs/Air interfaces, and thus reduce the carriers recombination rate, and secondly
 36 an optimized processing limiting as much as possible the plasma induced damages to
 37 the GaAs structure.

38 Moreover, whilst numerous bibliography references exist on GaAs etching for PhC
 39 membranes realization [20, 21, 22, 23], only a few of them deal with the various aspects
 40 of a full membrane fabrication, despite it strongly impacting the efficiency of the
 41 fabricated devices. Among these, [20] described a soft mask fabrication process for GaAs
 42 based PhC membranes showing that the steps following the PhC etching have a strong
 43 impact on the fully fabricated device aspect. In this paper, we propose an alternative
 44 full process that allows to fully remove the electrosensitive resist without N-methyl-
 45 pyrrolidone (NMP) solvent and most of all without having to resort to a combination of
 46 oxidation/deoxidation wet etching of the membrane.

47 In the following, we will first describe the different processing steps we used for PhC
 48 membrane fabrication. In the second section we show how each step was introduced in
 49 order to minimize plasma induced defect in the membrane structure and to remove any
 50 unwanted residue from the processing. In a last section, we show that the full procedure
 51 allowed us to fabricate PhC Distributed Feedback (DFB) lasers with experimental
 52 characteristics close to the predicted ones and showing a lower threshold than using
 53 a more straightforward approach.

54 2. Technological process description

55 The investigated structure is a 270-nm-thick GaAs membrane with 3 6-nm-thick
 56 embedded $\text{In}_{0.2}\text{Ga}_{0.8}\text{As}$ quantum wells (QWs). The samples were fabricated by
 57 Molecular Beam Epitaxy on GaAs (001) substrates with a 1.5- μm -thick $\text{Al}_{0.6}\text{Ga}_{0.4}\text{As}$
 58 sacrificial layer. As compared to structures used previously [10], described in figure 1 (a),
 59 we added 2 20-nm-thick $\text{Al}_{0.2}\text{Ga}_{0.8}\text{As}$ barriers 10-nm away from the bottom and top
 60 of the membrane layer, as shown in figure 1(b). These additional barriers limit
 61 carrier diffusion to the top and bottom GaAs/air interfaces and prevent non-radiative
 62 recombination [24].

63 Figure 2 presents the process-flow that was developed in this study. The first column
 64 (Figure 2 (a)) is the reference O_2 -free process flow described below. The second and third
 65 column (Figure 2 (b) and (c)) are alternative process flow with O_2 ashing that will help
 66 us better understand the possible damages caused by oxygen inside de membrane by
 67 studying the wet etching residues at the bottom of the surface left after hydrofluoric
 68 acid (HF) etching (dark green rocks). For e-beam lithography (green box figure 2 (a)),
 69 optimized photonic crystal DFB laser arrays, as proposed in [10] were patterned in the
 70 resist using a 20 kV electron-beam lithography tool (Raith 150) and standard CSAR-62
 71 commercial resist (350 nm). They are exposed at an uniform dose of $90 \mu\text{C cm}^{-2}$ and
 72 developed in amyl acetate for 60 s and then rinsed in isopropanol (IPA) for 60 s at room

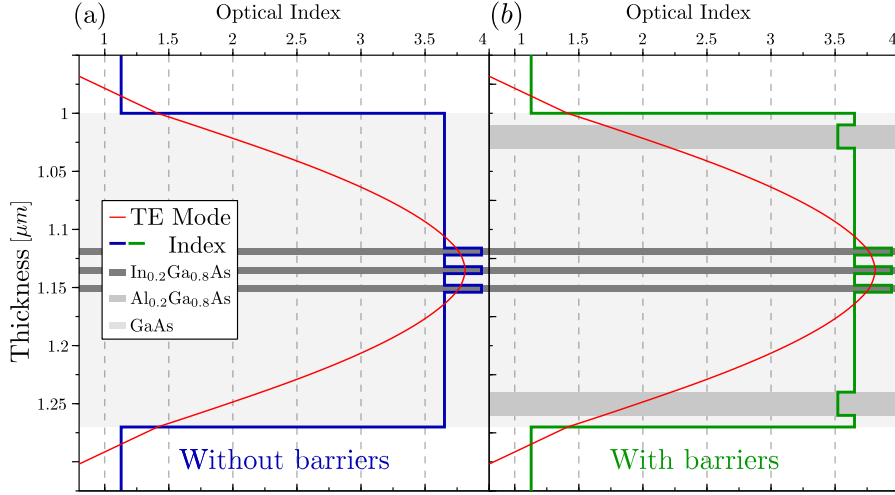

Figure 1. Comparison of membrane structures: (a) proposed in previous studies, (b) proposed in this paper. In light gray GaAs, in gray $\text{Al}_{0.2}\text{Ga}_{0.8}\text{As}$ barriers, in dark gray $\text{In}_{0.2}\text{Ga}_{0.8}\text{As}$. The TE mode profile considered is represented in red.

73 temperature. We then use hydrochloric acid solution for 90 s (HCl 37% mixed 1:3 by
 74 volume with deionised water (DI)) to remove oxides formed at the surface of the exposed
 75 areas.

76 The PhC holes are then transferred in the membrane by dry etching, more
 77 specifically inductively coupled plasma reactive ion etching (ICP-RIE) technique
 78 (Sentech Si-500) using Cl_2/N_2 chemistry [25, 26] (yellow box figure 2 (a)). Cl_2 is the main
 79 etching agent, ensuring physical etching driven by Cl ions and chemical etching driven
 80 by Cl radicals. N_2 promotes the deposition of a side-wall passivation which protects
 81 the vertical side-walls from lateral etching. We use etching parameters close to the ones
 82 of [27]: $\text{Cl}_2 = 50$ SCCM, $\text{N}_2 = 20$ SCCM, $T = 25^\circ\text{C}$, $P = 3$ mTor, duration = 37 s,
 83 $P_{ICP} = 200$ W and $P_{RF} = 60$ W. During the etching, samples are glued to an Si-carrier
 84 using a thermal glue (fomblin) to ensure good thermal contact between the sample and
 85 the carrier. Under these conditions we get a selectivity of around 3, which is enough
 86 to etch the holes of the photonic crystal through the 270-nm-thick membrane, while
 87 keeping a significant safety margin of CSAR62. After dry etching the remaining resist is
 88 removed using Dimethyl sulfoxide (DMSO) at a temperature of 80°C for 2h, and then
 89 rinsed in IPA (red box figure 2 (a)). However, as can be seen in figure 3 (a) a mixture of
 90 resist and etching residues are still present, particularly around each hole of the PhC.

91 The next processing step is the selective wet-etching of the sacrificial layer (blue
 92 boxes figure 2 (a)). As compared to previous studies, the protocol was modified to take
 93 into account the effects of native oxidization of the bottom of the holes laying in the
 94 Al-rich sacrificial layers (figure 2 (a) dark green areas at the holes side-walls). This thin
 95 film is not etched by HF [21, 28] and therefore is left beneath the PhC hole as residues
 96 after wet-etching of the sacrificial cladding layer [22].

97 We use a series of several bathes with intermediate rinsing in water for 60 s, which

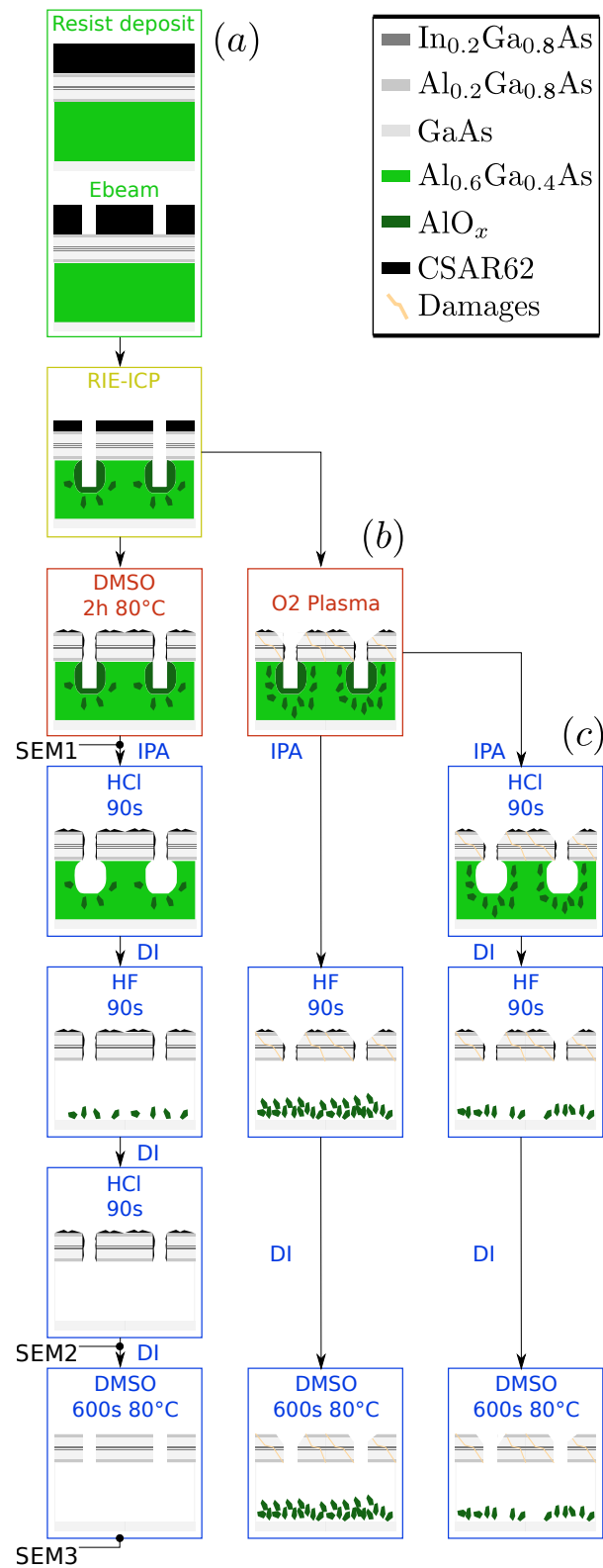

Figure 2. (a) reference process flow without O_2 plasma; (b) & (c) two alternate process flows with O_2 plasma ashing. Ethanol and nitrogen flow dries are not represented, but they take place after the final DMSO step.

98 are successively: a 300 s dip in IPA to ensure total wetting of the GaAs layers and air
 99 bubbles removal, a 90 seconds hydrochloric acid solution (HCl 37% mixed 1:3 with DI
 100 water by volume) to remove oxides formed at the surface of the sacrificial layer, specially
 101 on the side-walls of the photonic crystals (figure 2 (a) first HCl blue box) and eventually
 102 the HF sacrificial layer etching solution (HF 50% mixed 1:1 with DI water by volume)
 103 at room temperature and a magnetic stirrer for 90 s. We then proceed to a second
 104 deoxidation step by dipping the sample again in the HCl solution. This step allows
 105 to properly clean the sample from most of the residues left by wet and dry etching,
 106 specially the remaining oxides present inside the sacrificial layer (figure 2 (a) last HCl
 107 blue box: green residues are no longer present). However, as can be seen in figure 3 (b)
 108 some residues are still present around the sidewall of the holes.

109 The last cleaning step consists in removing the possible remaining resist by means of
 110 a DMSO solution and a stirring hot plate at a temperature of 80 °C for 600 s (figure 2 (a)
 111 DMSO blue box). As can be seen in figure 3 (c) the sample is now free from resist or
 112 etching residues.

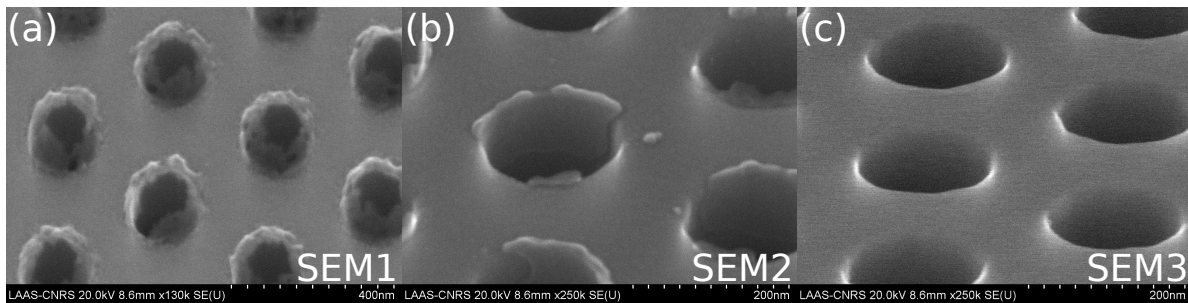

Figure 3. SEM images of PhC holes: (a) after first DMSO cleaning, (b) after wet etching but before final DMSO cleaning and (c) after final DMSO cleaning. They correspond respectively to SEM1, SEM2 and SEM3 along the process flow (a) in figure 2.

113 Eventually, in order to reduced the capillary forces during the drying step, we
 114 dip the sample in ethanol for 30s before gently drying using nitrogen flow. As thin
 115 suspended GaAs membranes have moderate stiffness, capillary forces and subsequent
 116 inter-solid adhesion might lead to a collapse onto the substrate [29]. To prevent any
 117 collapse, we pay special attention to keep the entire sample under a liquid droplet during
 118 the whole process, in particular when transferring from one bath to the next.

119 Figure 4 shows a scanning electron microscope (SEM) image of a sample fabricated
 120 using this process. As seen in figure 4(a) it consists of PhC waveguides of different
 121 lengths, with varying lattice constant a . Inset (b) and (c) show details of the PhC
 122 waveguide homogeneity and of the smoothness and verticality of the holes that is
 123 achieved using the previously exposed plasma parameters.

124 Figure 5 shows a Focussed Ion Beam Etching (FIBE) cut of a suspended PhC
 125 membrane laser. Some Gallium droplets can be seen along the edge of the cut, it is
 126 an artifact of the FIBE. The insert is a schematic representation of the suspended PhC
 127 laser.

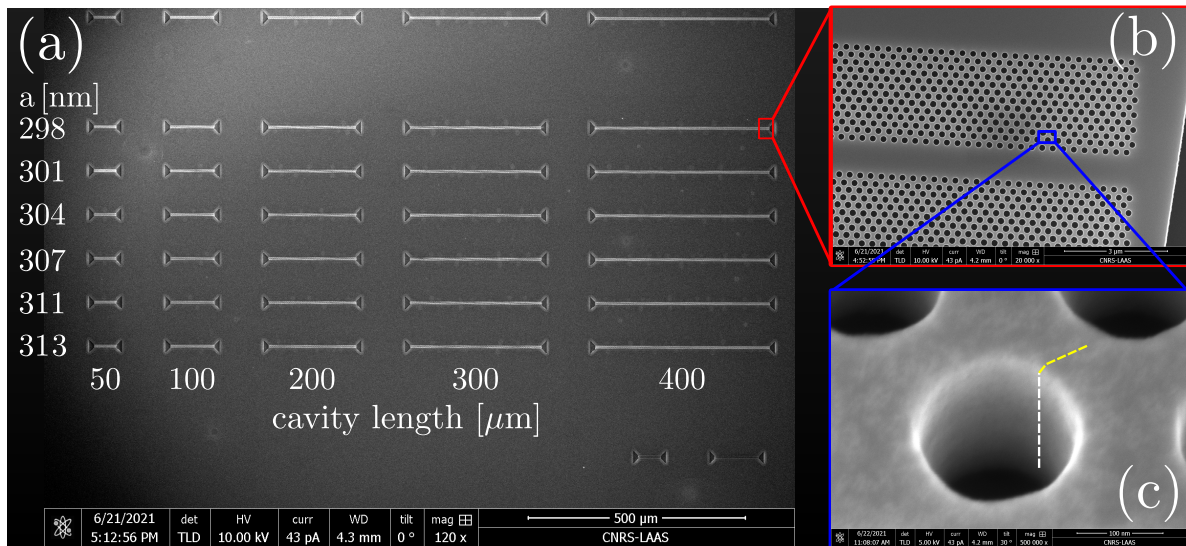

Figure 4. SEM image of the membrane DBR lasers. (a) View of the DBR lasers with increasing cavity lengths and lattice constant a . (b) Close-up on the red zone showing the homogeneity along defect waveguide in the PhC lattice. (c) Close-up on the blue zone showing the quality of the sidewall of the PhC hole. Yellow and white dashed lines are guide to the eye to appreciate hole sharpness and verticality.

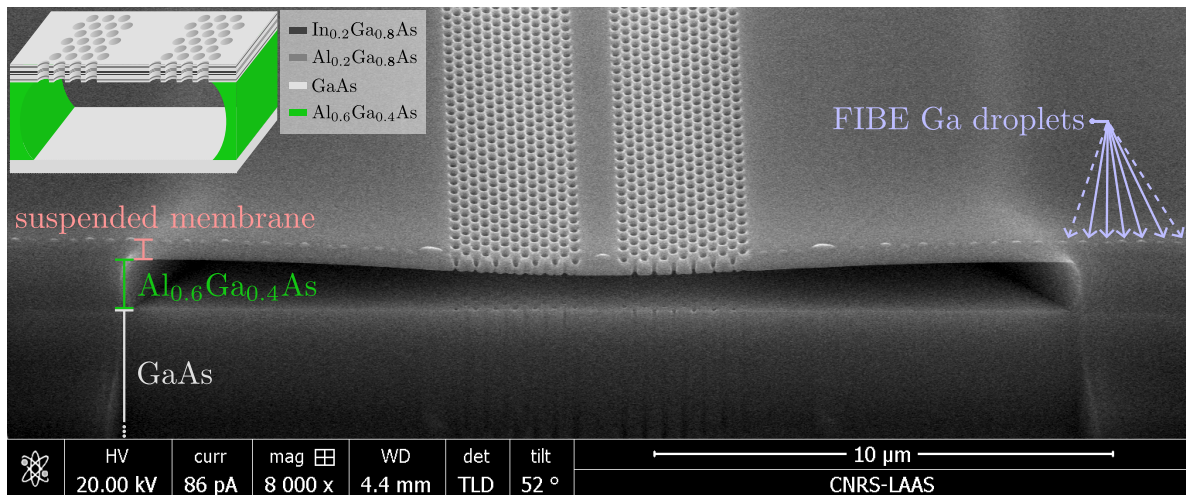

Figure 5. SEM image of the cross section of one suspended PhC membrane laser, obtained using FIBE. The insert is a schematic representation of the suspended PhC membrane laser, with the corresponding layers. The 270 nm suspended membrane is pointed out using the orange delimiter. Its composition corresponds to Figure 1 (b). The Al_{0.6}Ga_{0.4}As sacrificial layer is pointed out using the green delimiter. The GaAs substrate is pointed out using the white delimiter.

128 3. Results and discussion

129 This section aims to justify the different fabrication steps of the proposed process flow.
 130 More specifically, we focus on the advantage of using organic solvent for resist stripping,
 131 instead of oxygen plasma ashing. We first show the role that oxygen plasma may play

132 in changing the shape and size of the PhC holes. Then we show that oxygen plasma
 133 may induce damages inside the membrane and the QW despite the resist protection,
 134 therefore degrading the optoelectrical properties of the QWs [30, 31, 32], and introducing
 135 non radiative recombination sites [18, 33] enhancing losses.

136 *3.1. Impact of oxygen plasma on hole size and shape*

137 To highlight the impact of oxygen plasma, we prepared a sample using an alternative
 138 process flow (figure 2 (b)) where resist is stripped using O_2 plasma ashing instead of
 139 using DMSO. The ashing is carried out in the same chamber used for the dry etching
 140 ($O_2 = 80$ SCCM, $T=25^\circ C$, $P = 15$ mTorr, $P_{RF} = 50$ W and $P_{ICP}=800$ W).

141 We monitored in-situ the resist etching using an optical reflectivity end point
 142 detection system. The resist from the large surfaces is completely etched after about
 143 30s of plasma ashing. We introduced different overetching times to completely remove
 144 resist from PhC holes.

145 Figure 6 shows a SEM image of the surface of our PhC after 46 s of O_2 plasma,
 146 before wet etching.

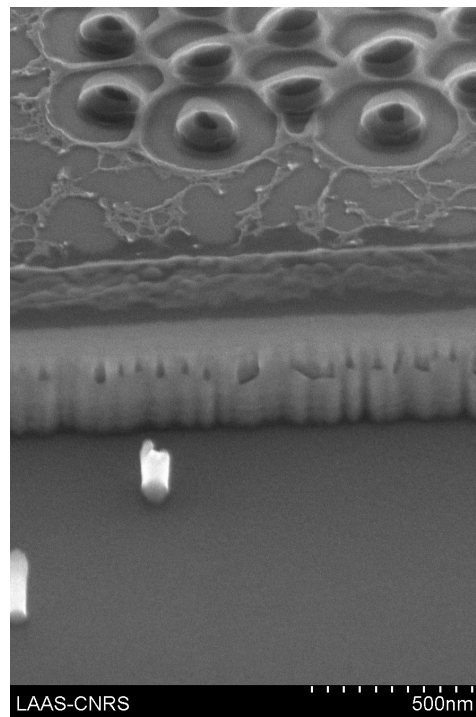

Figure 6. SEM image of PhC holes for plasma etching of 46 s, before wet etching.

147 Resist residues are still present, specially at the borders of the PhC holes. We
 148 did not managed to remove these residues even after dipping our sample for 48 h
 149 in acetone. This is due to resist hardening by ion bombardment during the dry
 150 etching. Other strategies for removing this residues include potassium hydroxide
 151 selective etching [21, 23] and digital etching [20, 34]. The use of potassium hydroxide

152 in a clean room with CMOS compatible processes requires a complex purification and
 153 neutralization process that requires dipping the sample multiple times in DI water and
 154 acetic acid. These multiple steps increase the probability of losing the surface droplet of
 155 liquid, which will result in the collapse of our suspended membrane. Moreover, KOH will
 156 slightly increase the holes diameter [20], whilst acetic acid is used in many GaAs surface
 157 preparations [35] and sometimes leads to holes geometry modifications. Concerning the
 158 second strategy, digital etching involves oxidizing the remaining resist in order to obtain
 159 volatile compounds such as CO_2 [20]. A deoxidation step is then essential in order
 160 to clean the sample from GaAs oxides. This has a direct impact on geometrical and
 161 optical properties of DFB photonic structures [1, 36] as each step reduces the membrane
 162 thickness and increases the diameter of the PhC holes.

163 We increased the overetching duration to try to remove all the resist, specially the
 164 one present at the borders of the PhC holes. Figure 7 (a) and (b) show SEM images
 165 of the surface of our PhC after the wet etching procedure, for two different O_2 plasma
 166 durations: 330 s and 70 s.

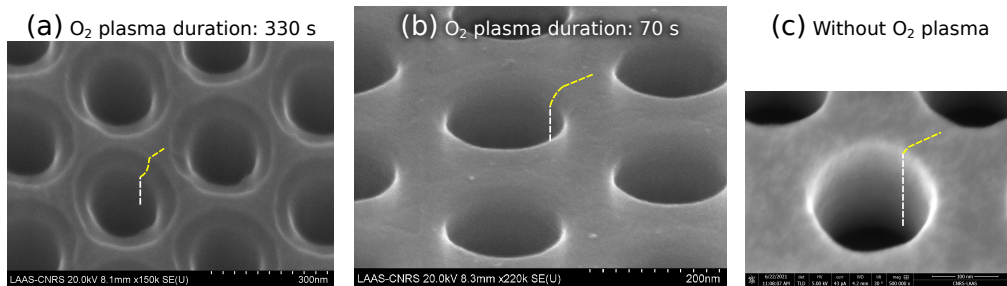

Figure 7. SEM image of PhC holes after wet etching: after (a) 330s and (b) 70s of O_2 plasma ashing; (c) using the O_2 -free process of figure 2 (a). The vertical white dashed lines represent the intern sidewalls of the holes, the yellow dashed lines their top edge.

167 From figure 7 (a) and (b) we can clearly see that the top edge of the holes has a
 168 torus like form. It is easier to see, from figure 7 (a) the torus like form thanks to the
 169 contrast difference. We use white and yellow dashed lines as guides for the eye. The
 170 white dashed lines represent the vertical side-walls of the inside of the PhC holes. The
 171 yellow dashed lines the surface of the sample. The discontinuity between this dashed
 172 lines shows that the border of the holes are not vertical and are rounded, which increases
 173 their size. This effect is stronger for longer O_2 plasma (figure 7 (a)) than for shorter ones
 174 (figure 7 (b)). From figure 7 (c) we can see that this is not the case for the improved
 175 process (figure 2 (a)), as the sidewall/surface transition is sharper. In conclusion oxygen
 176 plasma over etches the top of PhC holes, affecting their size and geometry. This deviation
 177 from cylindrical hole geometry tends to increase discrepancies between expected and
 178 observed photonic properties and it hinders accurate hole diameter estimation needed
 179 to simulate the fabricated devices.

180 *3.2. Impact of oxygen plasma on the oxidation of the membrane*

181 In this section we discuss how oxygen plasma might introduce lattice defects and
 182 damages by implantation inside the membrane and the quantum wells [30], thus creating
 183 non radiative recombination sites [33]. This effect can be tracked by studying the
 184 composition of the residues left after the sacrificial layer etching (figure 2 (b) and (c)).

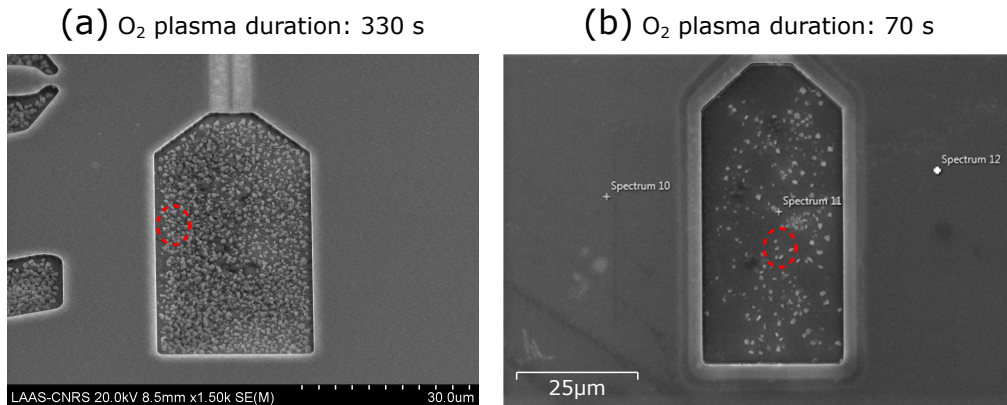

Figure 8. Scanning electron microscope (SEM) image of the bottom of the substrate after O₂ plasma ashing then wet etching of the sacrificial layer using only HF. Both samples were in contact with oxygen plasma at the same conditions as the ones showed in figure 7 (a) and (b). (a) 330 s of oxygen plasma and (b) 70 s of oxygen plasma. The red circles highlight some residues at the bottom of the substrate.

185 For this we use O₂ plasma ashing for resist removal (dry etching followed by O₂
 186 plasma instead of DMSO, processes (b) of figure 2). We then etch the sacrificial layer
 187 using only HF without any HCl treatment, as shown in figure 2 (b). The results of
 188 the wet etching of micrometric patterns are shown in figure 8 for two oxygen plasma
 189 durations: (a) 330 s and (b) 70 s. We see in figure 8 (a) a large number of rocks (dust-like
 190 gray structure covering the central part of the figure which corresponds to the bottom
 191 of the sacrificial layer). Figure 8 (b) exhibits the same rocks (dashed red circles). The
 192 density of these rocks is clearly linked to the O₂ plasma duration.

193 Such feature have already been observed. For example [20] observed fluoride based
 194 crystal (AlF₃). This is not the case here as these rocks do not show the crystalline
 195 characteristic form of AlF₃ and are not soluble in water, even after a rinse in H₂O for
 196 600s.

197 [21, 28] pointed out the observation of an oxide compound (Al_xO_y) that comes
 198 from the aluminium-rich sacrificial layer and the contact with either O₂ plasma, residual
 199 oxygen present in the dry etching chamber, or ambient oxygen. We performed an Energy
 200 Dispersive X-Ray Analysis (EDX) to assess the presence of oxygen in the rocks.

201 The results from EDX are shown in figure 9. For the substrate, no oxygen line
 202 appear in the EDX spectrum (figure 9 (b)), while for rocks (figure 9 (c) and (d)), the
 203 spectra reveal the presence of oxygen (0.5 KeV). As for the compound signature of Ga-
 204 (1.098 KeV, 9.241 KeV) and As- (1.282 KeV, 10.530 KeV), we found the same intensity

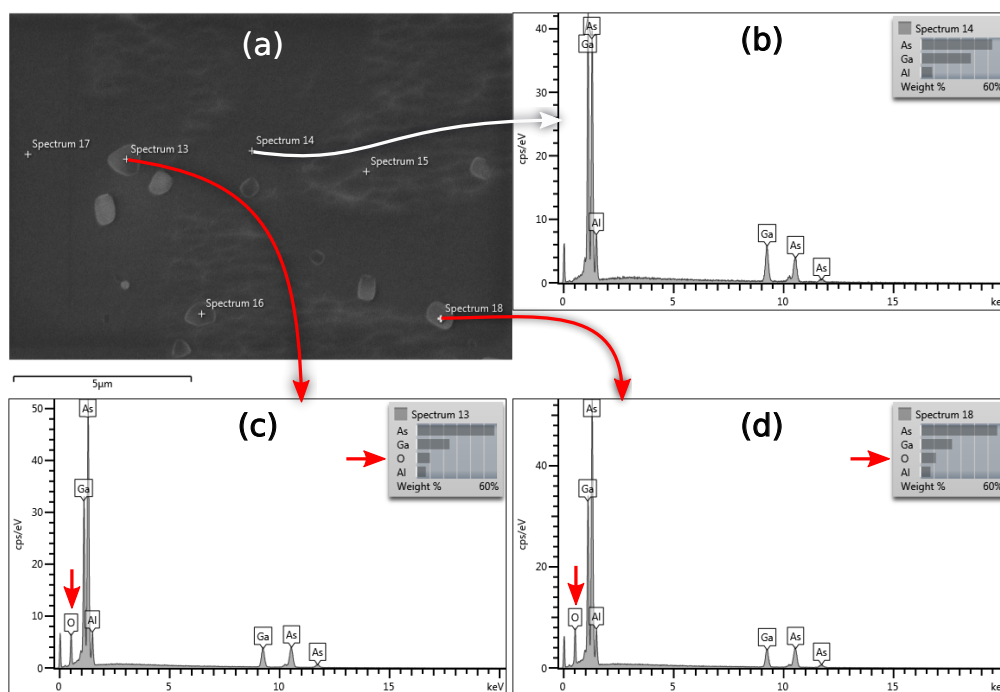

Figure 9. EDX measurements after wet etching of the sacrificial layer: SEM image of the substrate with rocks (a) ; EDX spectra of the substrate (b) and of two isolated rocks (c) and (d).

205 levels for rocks and the substrate. One possible explanation is that this signal comes
 206 from the interaction of the EDX ray with the substrate and not the rocks. From these
 207 EDX spectra, we conclude that the rocks contain oxygen. Moreover, as the rocks were
 208 not etched by HF, they might correspond to an Al_xO_y oxide compound.

209

210 To furthermore understand the formation of these compounds, we tested the process
 211 (c) of figure 2, adding a de-oxidation after the O_2 plasma, before the sacrificial layer wet
 212 etching. If these Al_xO_y were only created on the surface of the exposed $Al_{0.6}Ga_{0.4}As$
 213 layer, this step should allow their removal. However, surprisingly, we still found rocks,
 214 in a density increasing with the O_2 plasma duration. The sole explanation is that these
 215 Al_xO_y compounds are not only created on the exposed side-walls, but also inside the
 216 $Al_{0.6}Ga_{0.4}As$ layer. Such process are possible and have been used to demonstrate sub-
 217 surface oxidation of AlAs layers [31, 32]. It should be noted that these rocks can also
 218 be found below the PhC membranes.

219

In conclusion, we believe that oxygen plasma is not suited for resist removal, first
 220 because it degrades the geometry of the PhC holes, and second because it is able to
 221 implant oxygen in the semiconductor, potentially creating defects in the GaAs membrane
 222 (which is only covered by a small residual layer of resist at this stage of the process).

223

We thus ended with our reference dry etching procedure, as shown in figure 2 (a),
 224 for which we replace oxygen plasma with an organic solvent DMSO in order to remove
 225 the resist. DMSO was chosen for its low toxicity as compared to other solvents such as

226 NMP used in [20] for example.

227 4. Optical results

228 In this section we assess the impact of both the inclusion of the barrier in the vertical
 229 stack (see figure 1) and the new process without oxygen plasma (see figure 2) on the
 230 optical characteristics of the membranes.

231 Figure 10 shows the photoluminescence spectra of unprocessed wafers for both
 232 structures described in figure 1: in solid green for the membrane with additional barriers,
 233 in solid blue without the barrier, in dashed blue without the barrier using a $\times 20$ intensity
 234 magnification. Both spectra were recorded using identical conditions (continuous-wave,
 235 200 mW, 532 nm excitation) and are plotted using the same arbitrary intensity units.
 236 The addition of the barriers results in a 20-fold enhancement of the luminescence, on
 237 the un-etched structure, with only a single Air/GaAs interface. Our interpretation is
 238 that the barriers prevent the optically-generated carriers to recombine non-radiatively
 239 on the top surface of the structure, and that the effect will be even stronger on the
 240 membrane.

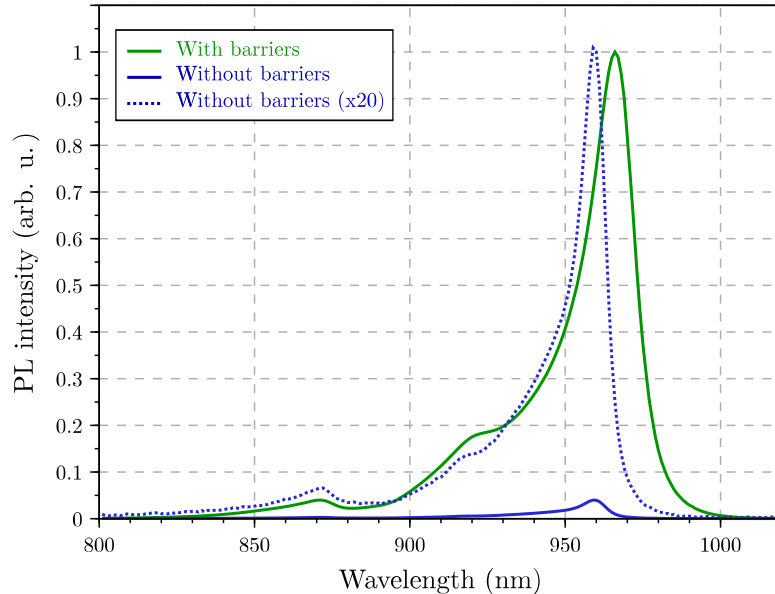

Figure 10. Photoluminescence emission from active membrane: without barriers (blue) corresponding to figure 1 (a) and with barriers (green) corresponding to figure 1 (b).

241 To assess the impact of both the barrier and our novel processing, we fabricated
 242 2nd order DFB lasers using an optimized deformation scheme as reported in [10]. The
 243 photonic defect waveguide acting as the DFB cavity relies on the same deformation
 244 parameters ($\alpha = 0.82$ and $\epsilon = 1.04$) and hole radius $r = 0.3a$ as in [10], where a is the
 245 lattice constant of the PhC.

246 Figure 11(a) shows the band diagram of the considered structure (gray) together

247 with the fundamental mode guided in the defect (black) and the second folding point at
 $k_x = 0$ and $u_0 \simeq 0.312$ (yellow). We want to excite the mode at this second folding point

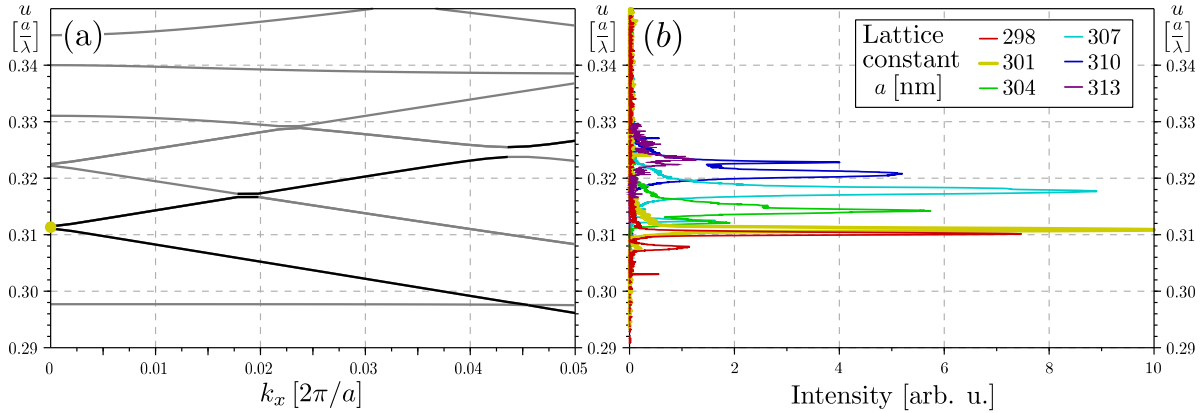

Figure 11. (a) Band diagram of the PhC waveguide (gray), fundamental guided mode (black) and DFB mode at the 2nd folding point (yellow). (b) Emission spectra above threshold for 300- μm -long cavities for different lattice parameters a .

248

249 where we can get efficient DFB lasing. As the gain peak in the membrane is around
 250 $\lambda_0 = 980$ nm this corresponds to a lattice parameter $a_0 = \lambda_0 \times u_0 \simeq 305$ nm and a radius
 251 $r \simeq 92$ nm. In order to accommodate for fabrication uncertainties and dispersion in our
 252 material we fabricate DFB lasers with six different lattice parameters from $a = 298$ nm
 253 to $a = 313$ nm with a pitch of 3 nm, while keeping $r/a = 0.3$. The fabricated DFB lasers
 254 are shown in figure 4 (a), where each column corresponds to a different cavity length
 255 and each row to a different lattice parameter.

256 Figure 11(b) shows the laser spectral emissions under optical pumping by an
 257 elliptical beam aligned with the waveguides for the 300- μm -long lasers, in units of a/λ ,
 258 as a function of the lattice constant (colour code). We can observe two different type of
 259 emissions.

260 For $a = [298, 304 - 313]$ nm, the spectrum is broad-band and contain multiple peaks. It
 261 corresponds to Fabry-Pérot laser emission for the free propagating mode guided in the
 262 defect and confined longitudinally by the etch mirrors at both ends of the waveguide.

263 For $a = 301$ nm (yellow), we observe a narrower and brighter emission corresponding the
 264 DFB mode at the second folding point. The observed experimental reduced frequency
 265 of $u = 0.311$ is in good agreement with the predicted one $u_0 \simeq 0.312$.

266 Figure 12 shows the emitted versus pump power curves recorded for lasers with a
 267 lattice parameter $a = 301$ nm and with cavity lengths of 300 μm (a) and 50 μm (b). A
 268 clear emission threshold is observed, at powers of 17 kW/cm^2 (300- μm -long cavity) and
 269 40 kW/cm^2 (50- μm -long cavity).

270 The laser emission threshold of the 300- μm -long cavity is about 17 kW/cm^2 ,
 271 which is 8 times lower than the previously reported thresholds for such cavities
 272 ($\simeq 127$ kW/cm^2) [10]. As for 50- μm -long cavity, no laser emission was possible using
 273 the membranes without barrier and the fabrication process with oxygen plasma. This is

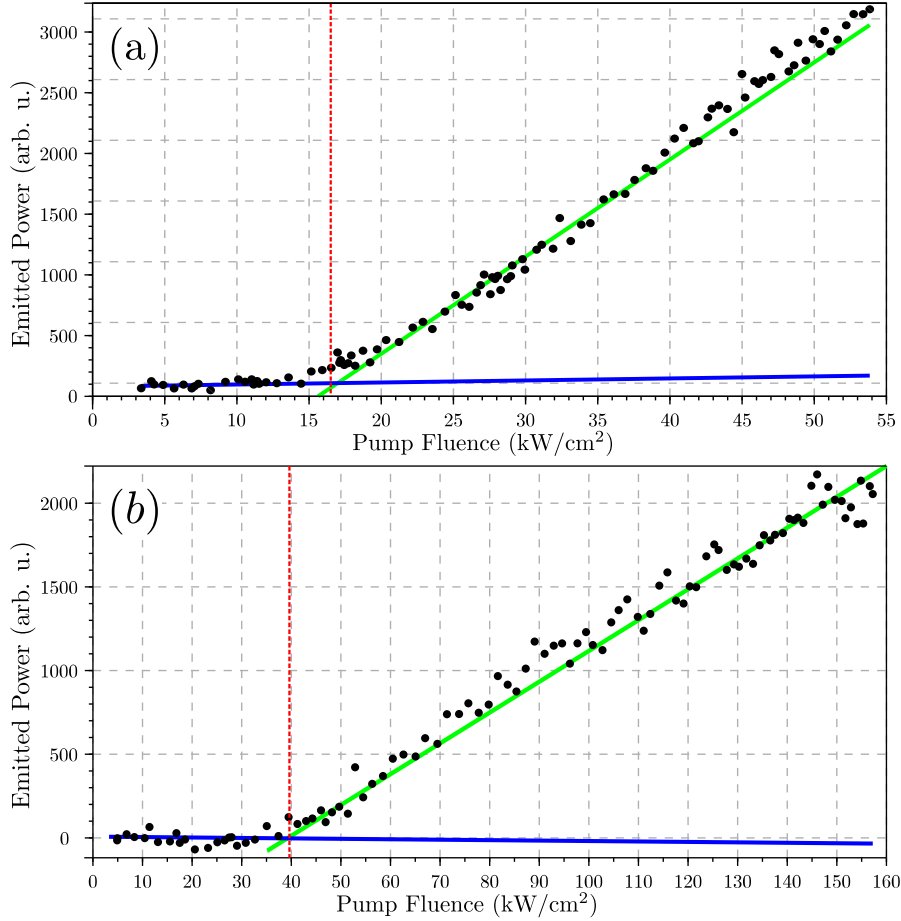

Figure 12. Emitted power versus pump fluence for (a) 300- μm and (b) 50- μm -long cavities. The red vertical dashed lines represent the laser threshold for each cavity.

274 a clear indication of the quality of the achieved PhC waveguides through our upgraded
 275 process, and of the impact of the AlGaAs barriers to prevent surface recombination
 276 of carriers at the GaAs/air interfaces. However, balancing the effect of the process
 277 improvement as compared to the barriers impact is difficult, and would involve a
 278 comparison between successive samples with different barriers and comparable process.

279 5. Conclusion

280 We have reviewed the complete classical fabrication process of GaAs active PhC
 281 membranes, from the epitaxial structure to the wet etching technique.

282 Particular attention was devoted to reducing the non-radiative recombination that
 283 occurs at the GaAs/air interfaces. For this we presented a new epitaxial structure
 284 that includes two AlGaAs barriers, near the top and bottom surface of the membrane,
 285 that significantly reduced the non-radiative recombination, rather than using chemical
 286 passivation [33, 37]. This resulted in a 20-fold enhancement of the luminescence of QWs.

287 On the processing side, we focused on using soft solvent-based stripping steps rather
 288 than plasma-based stripping and achieved complete cleaning of the sample together with

289 a good preservation of the geometrical parameters of our PhC holes.

290 The combination of both improvements allowed the demonstration of GaAs PhC
291 lasers with ultra-short cavities.

292 6. Acknowledgements

293 This work was supported by LAAS-CNRS micro and nanotechnologies platform,
294 member of the French RENATECH network. Calculations were performed using HPC
295 resources from CALMIP (Toulouse, France) under Allocation No. 2020-P20045.

296 7. Bibliography

297 References

- 298 [1] K. Hennessy, A. Badolato, A. Tamboli, P. M. Petroff, E. Hu, M. Atatüre, J. Dreiser,
299 and A. Imamoglu. Tuning photonic crystal nanocavity modes by wet chemical
300 digital etching. *Applied Physics Letters*, 87(2):021108, jul 2005.
- 301 [2] Yasutomo Ota, Masahiro Nomura, Naoto Kumagai, Katsuyuki Watanabe, Satomi
302 Ishida, Satoshi Iwamoto, and Yasuhiko Arakawa. Enhanced photon emission and
303 absorption of single quantum dot in resonance with two modes in photonic crystal
304 nanocavity. *Applied Physics Letters*, 93(18):183114, nov 2008.
- 305 [3] D. G. Gevaux, A. J. Bennett, R. M. Stevenson, A. J. Shields, P. Atkinson,
306 J. Griffiths, D. Anderson, G. A. C. Jones, and D. A. Ritchie. Enhancement and
307 suppression of spontaneous emission by temperature tuning InAs quantum dots to
308 photonic crystal cavities. *Applied Physics Letters*, 88(13):131101, mar 2006.
- 309 [4] Thang Ba Hoang, Johannes Beetz, Leonardo Midolo, Matthias Skacel, Matthias
310 Lerner, Martin Kamp, Sven Höfling, Laurent Balet, Nicolas Chauvin, and Andrea
311 Fiore. Enhanced spontaneous emission from quantum dots in short photonic crystal
312 waveguides. *Applied Physics Letters*, 100(6):061122, feb 2012.
- 313 [5] M. Arcari, I. Söllner, A. Javadi, S. Lindskov Hansen, S. Mahmoodian, J. Liu,
314 H. Thyrrestrup, E.H. Lee, J.D. Song, S. Stobbe, and P. Lodahl. Near-unity
315 coupling efficiency of a quantum emitter to a photonic crystal waveguide. *Physical
316 Review Letters*, 113(9):093603, aug 2014.
- 317 [6] K. Hennessy, A. Badolato, M. Winger, D. Gerace, M. Atatüre, S. Gulde, S. Fält,
318 E. L. Hu, and A. Imamoglu. Quantum nature of a strongly coupled single quantum
319 dot–cavity system. *Nature*, 445(7130):896–899, jan 2007.
- 320 [7] Gabriel Marty, Sylvain Combrié, Fabrice Raineri, and Alfredo De Rossi. Photonic
321 crystal optical parametric oscillator. *Nature Photonics*, 15(1):53–58, dec 2020.
- 322 [8] Ilya Fushman, Dirk Englund, Andrei Faraon, Nick Stoltz, Pierre Petroff, and
323 Jelena Vuckovic. Controlled phase shifts with a single quantum dot. *Science*,
324 320(5877):769–772, may 2008.

- 325 [9] A. Javadi, I. Söllner, M. Arcari, S. Lindskov Hansen, L. Midolo, S. Mahmoodian,
326 G Kiršanskė, T. Pregolato, E. H. Lee, J. D. Song, S. Stobbe, and P. Lodahl.
327 Single-photon non-linear optics with a quantum dot in a waveguide. *Nature*
328 *Communications*, 6(1), oct 2015.
- 329 [10] A. Larrue, J. Campos, O. Gauthier-Lafaye, A. Monmayrant, S. Bonnefont, and
330 F. Lozes-Dupuy. All photonic crystal DFB lasers robust toward optical feedback.
331 *Selected Topics in Quantum Electronics, IEEE Journal of*, 17(5):1236 – 1241, 2011.
- 332 [11] X. Checoury, P. Boucaud, J-M. Lourtioz, F. Pommereau, C. Cuisin, E. Derouin,
333 O. Drisse, L. Legouezigou, F. Lelarge, F. Poingt, G. H. Duan, D. Mulin,
334 S. Bonnefont, O. Gauthier-Lafaye, J. Valentin, F. Lozes, and A. Talneau.
335 Distributed feedback regime of photonic crystal waveguide lasers at $1.5\mu\text{m}$. *Applied*
336 *Physics Letters*, 85(23):5502–5504, dec 2004.
- 337 [12] X. Checoury, P. Boucaud, J.-M. Lourtioz, F. Pommereau, C. Cuisin, E. Derouin,
338 O. Drisse, L. Legouezigou, O.L. Legouezigou, F. Lelarge, F. Poingt, Guang-
339 Hua Duan, S. Bonnefont, D. Mulin, J. Valentin, O. Gauthier-Lafaye, F. Lozes-
340 Dupuy, and A. Talneau. Distributed feedback-like laser emission in photonic
341 crystal waveguides on InP substrate. *IEEE Journal of Selected Topics in Quantum*
342 *Electronics*, 11(5):1180–1186, sep 2005.
- 343 [13] O. Gauthier-Lafaye, D. Mulin, S. Bonnefont, X. Checoury, J.-M. Lourtioz,
344 A. Talneau, and F. Lozes-Dupuy. Highly monomode w1 waveguide square lattice
345 photonic crystal lasers. *IEEE Photonics Technology Letters*, 17(8):1587–1589, aug
346 2005.
- 347 [14] Kuon Inoue, Hidekazu Sasaki, Koji Ishida, Yoshimasa Sugimoto, Naoki Ikeda,
348 Yu Tanaka, Shunsuke Ohkouchi, Yusui Nakamura, and Kiyoshi Asakawa. InAs
349 quantum-dot laser utilizing GaAs photonic-crystal line-defect waveguide. *Optics*
350 *Express*, 12(22):5502, 2004.
- 351 [15] Fariborz Parandin, Farsad Heidari, Zahra Rahimi, and Saeed Olyaei. Two-
352 dimensional photonic crystal biosensors: A review. *Optics & Laser Technology*,
353 144:107397, dec 2021.
- 354 [16] Rami Zegadi, Abdelouahab Zegadi, Chemseddine Zebiri, Said Mosbah, Samira
355 Mekki, Mohamed Lamine Bouknia, and Hanane Bendjedi. Enhanced 2d photonic
356 crystal sensor for high sensitivity sulfuric acid (h_2so_4) and hydrogen peroxide (h_2o_2)
357 detection. *Silicon*, mar 2022.
- 358 [17] Ehsan Veisi, Mahmood Seifouri, and Saeed Olyaei. Design and numerical analysis
359 of multifunctional photonic crystal logic gates. *Optics & Laser Technology*,
360 151:108068, jul 2022.
- 361 [18] D.D. Nolte. Surface recombination, free-carrier saturation, and dangling bonds in
362 InP and GaAs. *Solid-State Electronics*, 33(2):295–298, feb 1990.
- 363 [19] Vasily N. Bessolov, Elena V. Konenkova, and Mikhail V. Lebedev. Solvent effect on
364 the properties of sulfur passivated gaas. *Journal of Vacuum Science & Technology*

- 365 *B: Microelectronics and Nanometer Structures Processing, Measurement, and*
366 *Phenomena*, 14(4):2761–2766, 1996.
- 367 [20] L Midolo, T Pregnolato, G Kiršanskė, and S Stobbe. Soft-mask fabrication of gal-
368 lium arsenide nanomembranes for integrated quantum photonics. *Nanotechnology*,
369 26(48):484002, nov 2015.
- 370 [21] J. Sweet, B.C. Richards, J.D. Olitzky, J. Hendrickson, G. Khitrova, H.M. Gibbs,
371 D. Litvinov, D. Gerthsen, D.Z. Hu, D.M. Schaadt, M. Wegener, U. Khankhoje,
372 and A. Scherer. GaAs photonic crystal slab nanocavities: Growth, fabrication, and
373 quality factor. *Photonics and Nanostructures - Fundamentals and Applications*,
374 8(1):1–6, jan 2010.
- 375 [22] Naoki Ikeda, Yoshimasa Sugimoto, Yu Tanaka, Kuon Inoue, Hisaya Oda, Yoshinori
376 Watanabe, and Kiyoshi Asakawa. Studies on key nano-fabrication processes
377 for GaAs-based air-bridge-type two-dimensional photonic-crystal slab waveguides.
378 *Semiconductor Science and Technology*, 22(2):149–157, jan 2007.
- 379 [23] Pisu Jiang and Krishna C. Balram. Suspended gallium arsenide platform for
380 building large scale photonic integrated circuits: passive devices. *Optics Express*,
381 28(8):12262, apr 2020.
- 382 [24] Hiroyuki Urabe, Makoto Kuramoto, Tomohiro Nakano, Atsushi Kawaharazuka,
383 Toshiki Makimoto, and Yoshiji Horikoshi. Effects of surface barrier layer in
384 AlGaAs/GaAs solar cells. *Journal of Crystal Growth*, 425:330–332, sep 2015.
- 385 [25] R. Braive, L. Le Gratiot, S. Guilet, G. Patriarche, A. Lemaître, A. Beveratos,
386 I. Robert-Philip, and I. Sagnes. Inductively coupled plasma etching of GaAs
387 suspended photonic crystal cavities. *Journal of Vacuum Science & Technology*
388 *B: Microelectronics and Nanometer Structures*, 27(4):1909, 2009.
- 389 [26] Kirill A. Atlasov, Pascal Gallo, Alok Rudra, Benjamin Dwir, and Eli Kapon.
390 Effect of sidewall passivation in bcl3 n2 inductively coupled plasma etching of two-
391 dimensional GaAs photonic crystals. *Journal of Vacuum Science & Technology B:*
392 *Microelectronics and Nanometer Structures*, 27(5):L21, 2009.
- 393 [27] Laurent Jalabert, Pascal Dubreuil, Franck Carcenac, Sébastien Pinaud, Ludovic
394 Salvagnac, Hugues Granier, and Chantal Fontaine. High aspect ratio GaAs
395 nanowires made by ICP-RIE etching using cl2/n2 chemistry. *Microelectronic*
396 *Engineering*, 85(5-6):1173–1178, may 2008.
- 397 [28] Thor Bakke, Jan Schmidt, Martin Friedrichs, and Benjamin Völker. Etch stop
398 materials for release by vapor hf etching. *Micromechanics Europe*, 122:68, 2005.
- 399 [29] Roya Maboudian. Critical review: Adhesion in surface micromechanical structures.
400 *Journal of Vacuum Science & Technology B: Microelectronics and Nanometer*
401 *Structures*, 15(1):1, jan 1997.
- 402 [30] P. N. Favennec. Semi-insulating layers of GaAs by oxygen implantation. *Journal*
403 *of Applied Physics*, 47(6):2532–2536, jun 1976.

- 404 [31] C. Amat, G. Almuneau, P. Gallo, L. Jalabert, S. Mouldji, P. Dubreuil, T. Camps,
405 J.B. Doucet, E. Havard, V. Bardinal, C. Fontaine, and A. Munoz-Yague. Free
406 engineering of buried oxide patterns in GaAs/AlAs epitaxial structures. *Electronics*
407 *Letters*, 43(13):730, 2007.
- 408 [32] C.S. Peng, J. Konttinen, T. Jouhti, H.F. Liu, and M. Pessa. Wet oxidation for
409 detecting surface defect pits of AlGaAs related semiconductors. *Journal of Crystal*
410 *Growth*, 274(1-2):138–143, jan 2005.
- 411 [33] F. Capasso and G. F. Williams. A proposed hydrogenation/nitridization passivation
412 mechanism for GaAs and other III–v semiconductor devices, including InGaAs long
413 wavelength photodetectors. *Journal of The Electrochemical Society*, 129(4):821–
414 824, apr 1982.
- 415 [34] Gregory C. DeSalvo, Christopher A. Bozada, John L. Ebel, David C. Look, John P.
416 Barrette, Charles L. A. Cerny, Ross W. Dettmer, James K. Gillespie, Charles K.
417 Havasy, Thomas J. Jenkins, Kenichi Nakano, Carl I. Pettiford, Tony K. Quach,
418 James S. Sewell, and G. David Via. Wet chemical digital etching of GaAs at room
419 temperature. *Journal of The Electrochemical Society*, 143(11):3652–3656, nov 1996.
- 420 [35] A. R. Clawson. Guide to references on III–v semiconductor chemical etching.
421 *Materials Science and Engineering: R: Reports*, 31(1):1–438, 2001.
- 422 [36] T. Süner, R. Herrmann, A. Löffler, M. Kamp, and A. Forchel. Fine-tuning of
423 GaAs photonic crystal cavities by digital etching. *Microelectronic Engineering*,
424 84(5-8):1405–1407, may 2007.
- 425 [37] Xianshao Zou, Chuanshuai Li, Xiaojun Su, Yuchen Liu, Daniel Finkelstein-Shapiro,
426 Wei Zhang, and Arkady Yartsev. Carrier recombination processes in gaas wafers
427 passivated by wet nitridation. *ACS Applied Materials & Interfaces*, 12(25):28360–
428 28367, 2020. PMID: 32469493.