



HAL
open science

A Decoupling Scheme for Force Control in Cooperative Multi-Robot Manipulation Tasks

Luca de Pascali, Sebastian Erhart, Luca Zaccarian, Biral Francesco, Sandra Hirche

► **To cite this version:**

Luca de Pascali, Sebastian Erhart, Luca Zaccarian, Biral Francesco, Sandra Hirche. A Decoupling Scheme for Force Control in Cooperative Multi-Robot Manipulation Tasks. 2022 IEEE 17th International Conference on Advanced Motion Control (AMC), Feb 2022, Padova, Italy. pp.243-249, 10.1109/AMC51637.2022.9729263 . hal-03865089

HAL Id: hal-03865089

<https://laas.hal.science/hal-03865089>

Submitted on 22 Nov 2022

HAL is a multi-disciplinary open access archive for the deposit and dissemination of scientific research documents, whether they are published or not. The documents may come from teaching and research institutions in France or abroad, or from public or private research centers.

L'archive ouverte pluridisciplinaire **HAL**, est destinée au dépôt et à la diffusion de documents scientifiques de niveau recherche, publiés ou non, émanant des établissements d'enseignement et de recherche français ou étrangers, des laboratoires publics ou privés.

A Decoupling Scheme for Force Control in Cooperative Multi-Robot Manipulation Tasks

1st Luca De Pascali

Dep. of Industrial Engineering
University of Trento
Trento, Italy

2nd Sebastian Erhart

Dep. of Electrical and Computer Engineering
Technische Universität München
München, Germany

3rd Luca Zaccarian

Dep. of Industrial Engineering
University of Trento
Trento, Italy

4th Biral Francesco

Dep. of Industrial Engineering
University of Trento
Trento, Italy
francesco.biral@unitn.it

5th Sandra Hirche

Dep. of Electrical and Computer Engineering
Technische Universität München
München, Germany
hirche@lrs.ei.tum.de

Abstract—The internal forces and torques arising in cooperative manipulators ensembles are the grasp forces/torques and it is obviously desirable to control them. We present a novel approach that describes the internal loading as the interaction forces/torques arising in a multi-body system formed by multiple manipulators that behave like a formation of robots. We show that these quantities belong to the null space of the grasp matrix, thus they do not affect the dynamics of the object. The main contribution of this paper is a decoupling control scheme for tracking the internal and the motion-inducing forces and torques in a physically consistent way. The scheme is based on a physically and mathematically consistent model of the dynamics of the constrained interaction.

Index Terms—Cooperative Manipulation, Internal Forces, Interaction Dynamics, Impedance Control, Input Allocation

I. INTRODUCTION AND BACKGROUND MATERIAL

DEXTERITY and payload capacity of cooperative manipulator ensembles have moved the interest of the scientific community from single-arm robots configurations towards multi-arm robot technologies. In fact multi-robot cooperation is necessary in applications that require high load capacity, or when flexible objects or objects with extra degrees of freedom have to be handled, or even in the assembling of multiple parts. They can be employed in manufacturing, construction, forestry, medical applications and other domains. The challenge of the increased dexterity lies in the higher complexity of the robot configuration, which is mainly due to the redundancy of the system and to the coordination of the manipulators.

Force control in a cooperative manipulator ensemble is a quite considered topic in the literature and was first addressed in [1]. In many application it is desirable to control the squeezing (also named internal) forces and torques acting on the object. Undesired and uncontrolled internal forces can damage the manipulated object as well as the robotic arm itself; on the other hand, in many operations we would like to impose a desired value of the internal loading, for example in those situation where the contact between the object and the

tips of the manipulators is guaranteed by the friction in the contact points. Thus the design of a decoupled control scheme for tracking the desired object trajectory and the internal wrenches plays a vital role in the cooperative manipulation scenario. The relevance of a consistent internal force *and* torque model is mentioned in [2] and is consistently addressed in [3]. An interesting approach for the computation of internal forces is the *virtual linkage model* proposed in [4].

In a cooperative task each manipulator applies individually a force and a torque (or equivalently a *wrench*) to the object to obtain, in cooperation with the other manipulators, the desired object motion. The allocation of the manipulators wrenches is called *load distribution problem* [5]. The cooperative system is over-actuated, thus there exist infinitely many solutions to the load distribution problem, varying to each other for the different internal components that do not induce the motion of the object. Assuming the existence of a *non-squeezing* [6] load distribution strategy (in [3] it is shown that there exist infinitely many non-squeezing solutions), we can define the setpoints for the wrenches exerted by the manipulators on the object, that are free of internal components. The control scheme presented in [7] aims at tracking the desired object motion and the coordination of the manipulators by means of an impedance control scheme, but the control of the internal wrenches is not addressed. In this paper we show that the onset of the *squeezing* wrenches coupled with the motion-inducing ones does not affect the motion of the object, thus the tracking of the desired trajectory can be achieved neglecting the internal components. The main contribution of this paper is the design of a decoupling control scheme able to track the desired trajectory *and* the internal wrenches. A promising approach for the study of cooperative manipulators dynamics is proposed in [8] and [9], where the cooperative ensemble is considered as a constrained multi-body system. In [7] this approach is employed to express analytically the forces and torques arising in the interaction dynamics; the same authors compute the *internal* wrenches as the formation-violating forces and

torques arising in a system formed by the manipulators that moves together as a formation of robots¹.

In Section II we present a number of fundamental results derived from the definition of internal wrenches. These results are useful for the design of the decoupling scheme, performed in Section III; finally, in Section IV we illustrate the outcomes of a numerical simulation.

A. Preliminaries

We assume that N manipulators grasp an object and the grasp is assumed to be rigid. Each manipulator can exert both forces and torques on the object. As a consequence of the interaction with the cooperative setup, a force f_i and a torque t_i act on the i -th manipulator, for $i = \{1, \dots, N\}$. We define the i -th wrench as the stacked vector $h_i = [f_i^T, t_i^T]^T$. In Fig. 1, the kinematic quantities and the wrenches exchanged in the system are depicted. The vectors are expressed in the world

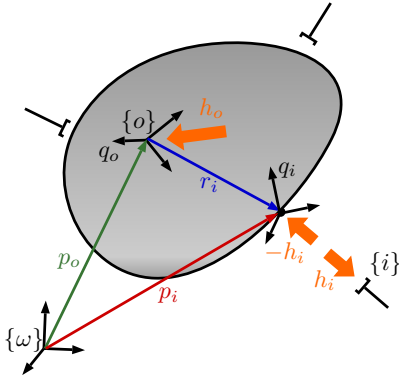

Fig. 1. Kinematic and dynamic quantities of interest in the cooperative manipulators setup.

reference frame $\{w\}$ if not indicated otherwise with a leading superscript. The object-fixed reference frame $\{o\}$ has the origin in the object center of mass. Moreover we define the i -th end effector reference frame $\{i\}$, for $i = \{1, \dots, N\}$. The pose of the i -th end effector x_i is composed by a translation $p_i \in \mathbb{R}^3$ and a rotation denoted by the unit quaternion $q_i \in \text{Spin}(3)$ ², namely $x_i = [p_i^T, q_i^T]^T$. Similarly the pose of the object center of mass is $x_o = [p_o^T, q_o^T]^T$. The distance between the object center of mass and the i -th manipulator is $r_i = p_i - p_o \in \mathbb{R}^3$, for each i . The end effectors wrenches $h = [h_1^T, \dots, h_N^T]^T$ are mapped in the wrenches acting at the object center of mass h_o through the so called *grasp matrix* $G(r) \in \mathbb{R}^{6 \times 6N}$ as

$$h_o = - \begin{bmatrix} I_3 & 0_3 & \dots & I_3 & 0_3 \\ S(r_1) & I_3 & \dots & S(r_N) & I_3 \end{bmatrix} h = -G(r)h \quad (1)$$

¹Internal wrenches can be seen equivalently as formation-violating (from the object point of view) or as formation-maintaining wrenches (from the manipulators point of view).

²The 3D rotation group $\text{Spin}(3)$ is a double cover of $\text{SO}(3)$, that is the group of all rotations about the origin of the three-dimensional Euclidean space \mathbb{R}^3 .

where $S(\cdot)$ indicates the skew symmetric matrix³ and I_m and 0_m denote respectively the $m \times m$ identity matrix and the $m \times m$ zero matrix. The vector $r = [r_1^T, \dots, r_N^T]^T$ contains the relative distances between the object center of mass and the manipulators, in fact $r_i = {}^w R_o(q_o) {}^o r_i$, for all i where ${}^o r_i \in \mathbb{R}^3$ is the (constant) position of the i -th end effector in the object reference frame $\{o\}$ and ${}^w R_o(q_o) \in \text{SO}(3)$ is the rotation matrix from $\{o\}$ to $\{w\}$.

The definition of internal wrenches is linked to the geometry of the grasp, in fact, in [6] the internal wrenches are defined as the wrenches lying in the null space of the grasp matrix. Recently, the authors of [3] provide the following more general definition.

Definition 1. Internal forces/torques are end effectors forces and torques for which the total virtual work is zero for any virtual displacement of the end effectors, compliant with the kinematic constraints.

We will show in Section II that the two definitions are equivalent.

B. Kinematic Constraints

The manipulated object is assumed to be rigid and the end effectors are assumed to be rigidly connected to it. Therefore we can study the ensemble of the end effectors and the object as a system of bodies constrained to each other by rigidity constraints. The position ${}^o r_i$ and the relative orientation ${}^o \delta q_i$ of the i -th end effector in $\{o\}$ remain constant for all i , thus we can write the velocity and the acceleration in $\{w\}$ as detailed in [7] differentiating the constrained positions, namely

$$\dot{x}_i = \begin{bmatrix} \dot{p}_i \\ \dot{\omega}_i \end{bmatrix} = \begin{bmatrix} \dot{p}_o + S(r_i)^T \omega_o \\ \omega_o \end{bmatrix} \quad (2a)$$

$$\ddot{x}_i = \begin{bmatrix} \ddot{p}_i \\ \ddot{\omega}_i \end{bmatrix} = \begin{bmatrix} \ddot{p}_o + S(r_i)^T \dot{\omega}_o + S(\omega_o)^2 r_i \\ \dot{\omega}_o \end{bmatrix}. \quad (2b)$$

Introducing the stacked velocity⁴ $\dot{x} = [\dot{x}_1^T, \dots, \dot{x}_N^T]^T \in \mathbb{R}^{6N}$ and acceleration $\ddot{x} = [\ddot{x}_1^T, \dots, \ddot{x}_N^T]^T \in \mathbb{R}^{6N}$ leads to the following compact form

$$\dot{x} = G(r)^T \dot{x}_o \quad (3a)$$

$$\ddot{x} = G(r)^T \ddot{x}_o + b, \quad (3b)$$

where the constraint acceleration condition in (3b) can be reformulated as

$$A \begin{bmatrix} \ddot{x}_o \\ \dot{x} \end{bmatrix} = b. \quad (4)$$

The constraint matrix $A \in \mathbb{R}^{6N \times 6(N+1)}$ and the vector $b \in \mathbb{R}^{6N}$ of the centripetal terms have the form

$$A = [-G(r)^T \quad | \quad I_{6N}], \quad \text{and} \quad b = \begin{bmatrix} S(\omega_o)^2 r_1 \\ 0_{3 \times 1} \\ \vdots \\ S(\omega_o)^2 r_N \\ 0_{3 \times 1} \end{bmatrix}. \quad (5)$$

³The skew symmetric matrix function $a \in \mathbb{R}^3 \rightarrow S(a) \in \mathbb{R}^{3 \times 3}$ implements the cross product, id est $S(a)b = a \times b$.

⁴We consider the twist velocities and accelerations. For this reason \dot{x} and \ddot{x} have dimensions $6N$.

II. CHARACTERIZATION OF THE INTERACTION DYNAMICS

Recalling [7], the equations describing the motion of the manipulators are

$$M(x)\ddot{x} = h^\Sigma + h, \quad (6)$$

where the inertia matrix is defined as $M(x) = \text{blkdiag}(m_1 I_3, J_1, \dots, m_N I_3, J_N) \in \mathbb{R}^{6N \times 6N}$. Notice that the wrenches acting on the manipulators are split into interaction wrenches h and non-interaction wrenches h^Σ . The wrenches h^Σ are all the wrenches acting on the manipulators except those arising as a consequence of the constrained interaction, which are named h .

The equations of motion for the object are obtained through Lagrangian mechanics yielding

$$M_o(x_o)\ddot{x}_o + C_o(x_o, \dot{x}_o)\dot{x}_o + h_g = \tilde{h}_o + h_o, \quad (7)$$

where $M_o(x_o), C_o(x_o, \dot{x}_o) \in \mathbb{R}^{6 \times 6}$ and $h_g \in \mathbb{R}^6$ denote respectively the inertial, centrifugal and gravitational terms. The disturbances \tilde{h}_o are due to external unmeasured wrenches or model uncertainties. The wrench h_o comes from the interaction with the manipulators and is related to the end effectors interaction wrenches h through (1). Similarly to (6), we split the interaction h and non-interaction h^Σ wrenches, as follows

$$M(x_o)\ddot{x}_o = h_o^\Sigma + h_o, \quad (8)$$

wherein $h_o^\Sigma = \tilde{h}_o - C(x_o, \dot{x}_o)\dot{x}_o - h_g$.

A. Interaction Dynamics

We aim at finding an explicit expression of the interaction wrenches h and h_o . In [10] the *Gauss' principle of least constraints* is solved on a system with acceleration constraints of the form (4) and leads to the result

$$\begin{bmatrix} h_o \\ h \end{bmatrix} = \check{M}^{\frac{1}{2}} (\check{A}\check{M}^{-\frac{1}{2}})^\dagger \left(b - \check{A}\check{M}^{-1} \begin{bmatrix} h_o^\Sigma \\ h^\Sigma \end{bmatrix} \right), \quad (9)$$

where the superscript \dagger denotes the Moore-Penrose pseudoinverse and matrix $\check{M} = \text{blkdiag}(M_o, M)$.

It is possible to show that matrix A exhibits some properties that guarantee the existence of the pseudo-inverse, thus the following result holds.

Theorem 1. *The interaction wrenches $h_o \in \mathbb{R}^6$ and $h \in \mathbb{R}^{6N}$ (resulting from the interaction between the object and the manipulators) are proportional to the extent to which the accelerations imposed by the non-interaction wrenches $h_o^\Sigma \in \mathbb{R}^6$ and $h^\Sigma \in \mathbb{R}^{6N}$ acting on the system tend to violate the acceleration constraints (3b). In particular, the following equation holds*

$$\begin{bmatrix} h_o \\ h \end{bmatrix} = A^T (\check{A}\check{M}^{-1}A^T)^{-1} \left(b - \check{A}\check{M}^{-1} \begin{bmatrix} h_o^\Sigma \\ h^\Sigma \end{bmatrix} \right). \quad (10)$$

Proof. Matrix A in (5) is full row-rank equal to $6N$ by construction. We know from [11, p. 88] that, since $\check{M}^{-\frac{1}{2}}$ has full rank equal to $6N$, then also $\check{A}\check{M}^{-\frac{1}{2}}$ is full row-rank. Therefore we can write its right inverse as

$$(\check{A}\check{M}^{-\frac{1}{2}})^\dagger = (\check{M}^{-\frac{1}{2}})^T A^T (\check{A}\check{M}^{-\frac{1}{2}}(\check{M}^{-\frac{1}{2}})^T A^T)^{-1}.$$

The inertia matrix \check{M} is symmetric, thus also $\check{M}^{-\frac{1}{2}}$ is symmetric and we can write

$$(\check{A}\check{M}^{-\frac{1}{2}})^\dagger = \check{M}^{-\frac{1}{2}} A^T (\check{A}\check{M}^{-1}A^T)^{-1}. \quad (11)$$

Substituting (11) in (9) yields (10). \square

With this result we can write the overall wrenches acting on the cooperative ensemble as a function of the non-interaction wrenches. Now we further inspect the dynamics of the object expressed in (7) in order to understand how the wrenches h^Σ are involved in the motion of the object. In a cooperative manipulators scenario these wrenches are the commanded wrenches provided at the end effectors. The new formulation in (10) allows to state the following Lemma, associated to Theorem 1.

Lemma 1. *The actual object acceleration is described by equation*

$$\ddot{x}_o = \mathcal{M}^{-1}(h_o^\Sigma + Gh^\Sigma - \tilde{b}), \quad (12)$$

where $\tilde{b} = GMb$ takes into account the centripetal terms, and the equivalent inertia matrix $\mathcal{M} = (M_o + GMG^T) \in \mathbb{R}^{6 \times 6}$ represents the actual inertia of the system comprising the object and the manipulators.

Proof. First we disclose the term $\check{A}\check{M}^{-1}A^T$ in (10) and, having in mind that A can be expressed as in (5), we obtain

$$\begin{aligned} (\check{A}\check{M}^{-1}A^T)^{-1} &= \left([-G^T \mid I_{6N}] \begin{bmatrix} M_o^{-1} & 0_{6 \times 6N} \\ 0_{6N \times 6} & M^{-1} \end{bmatrix} \begin{bmatrix} -G \\ I_{6N} \end{bmatrix} \right)^{-1} \\ &= (M^{-1} + G^T M_o^{-1} G)^{-1} = Q. \end{aligned} \quad (13)$$

We focus now on the term $\check{A}\check{M}^{-1}$, namely

$$\check{A}\check{M}^{-1} = [-G^T M_o^{-1} \mid M^{-1}] \quad (14)$$

Substituting (13) and (14) in (10) yields

$$\begin{bmatrix} h_o \\ h \end{bmatrix} = \begin{bmatrix} -G \\ I_{6N} \end{bmatrix} Q \left(b - [-G^T M_o^{-1} \mid M^{-1}] \begin{bmatrix} h_o^\Sigma \\ h^\Sigma \end{bmatrix} \right). \quad (15)$$

In particular the interaction wrench acting on the object becomes

$$h_o = -GQG^T M_o^{-1} h_o^\Sigma + GQM^{-1} h^\Sigma - GQb. \quad (16)$$

We replace h_o as in (16) into the object equations of motion (8) obtaining

$$M_o \ddot{x}_o = (I_6 - GQG^T M_o^{-1}) h_o^\Sigma + GQM^{-1} h^\Sigma - GQb. \quad (17)$$

Using the Woodbury matrix identity to expand Q in (13) yields

$$Q = M - MG^T \overbrace{(M_o + GMG^T)^{-1}}^{\triangleq \Theta} GM, \quad (18)$$

We thus substitute (18) in (17) and inspect each term of the expression; first consider the term multiplying h_o^Σ :

$$\begin{aligned} I_6 - GQG^T M_o^{-1} &= I_6 - \Theta M_o^{-1} - \Theta (M_o + \Theta)^{-1} \Theta M_o^{-1}, \\ &= I_6 - \Theta (M_o + \Theta)^{-1} (M_o + \Theta - \Theta) M_o^{-1} \\ &= I_6 - \Theta (M_o + \Theta)^{-1} \\ &= M_o (M_o + \Theta)^{-1}. \end{aligned} \quad (19)$$

Now we focus on the term multiplying h^Σ , namely

$$\begin{aligned} GQM^{-1} &= G - \Theta(M_o + \Theta)^{-1}G \\ &= M_o(M_o + \Theta)^{-1}G \end{aligned} \quad (20)$$

Similarly we inspect the term multiplying b and get

$$GQ = M_o(M_o + \Theta)^{-1}GM. \quad (21)$$

We define the matrix $\mathcal{M} = M_o + GMG^T$ which is the actual inertia of the overall system as stated in [7, th. 2]. Finally we substitute (19), (20) and (21) in (17) and obtain (12). \square

B. Internal Wrenches

Many authors identify the internal wrenches as those ones that do not induce any wrench h_o at the object center of mass; recalling (1), this means that internal wrenches have to be in the null space of the grasp matrix G . The Definition 1 proposed in [3] introduces a new approach. The following theorem shows that the two formulations are equivalent.

Theorem 2. *Given a constant set of end effectors wrenches acting on the object and collected in the stacked vector $h \in \mathbb{R}^{6N}$, the following are equivalent:*

- the wrenches h are internal (as specified in Definition 1);
- the wrenches h belong to the null space of the grasp matrix G .

Proof. According to Definition 1, the virtual work of a set of internal wrenches h along the virtual displacements δx compliant with the kinematic constraints is zero, namely

$$h^T \delta x = 0_{6N \times 1}.$$

Dividing all members by the time variation δt we get the constrained virtual velocities $\delta \dot{x}$, namely $h^T \frac{\delta x}{\delta t} = h^T \delta \dot{x} = 0_{6N \times 1}$. Notice that the ratio between the infinitesimal values δx and δt gives the finite velocity $\delta \dot{x}$. The constrained velocities of the end effectors are described by (3a), thus we can write

$$\begin{aligned} h^T \delta \dot{x} &= h^T G^T \delta \dot{x}_o \\ &= (Gh)^T \delta \dot{x}_o = 0_{6N \times 1}, \end{aligned} \quad (22)$$

where $\delta \dot{x}_o$ is any virtual velocity of the object, therefore (22) holds if and only if $Gh = 0_{6N \times 1}$. This means that the wrenches h are internal according to Definition 1 if and only if $h \in \text{Ker}(G)$. \square

In order to obtain a closed form equation for the internal wrenches we will adopt the approach proposed in [7] that characterizes the internal wrenches as the formation-maintaining wrenches arising in a subsystem built by the manipulators as depicted in Fig. 2. The end effectors can be thought of as a rigid formation of robots that exchange wrenches to maintain the formation, these wrenches are exchanged *through* the object and thus can be considered internal. This novel approach presented in [7] will be employed in this paper to design a decoupling control scheme for motion-inducing and internal wrenches. With the following theorem we show that the interaction wrenches arising in the subsystem in Fig. 2 are actually internal wrenches.

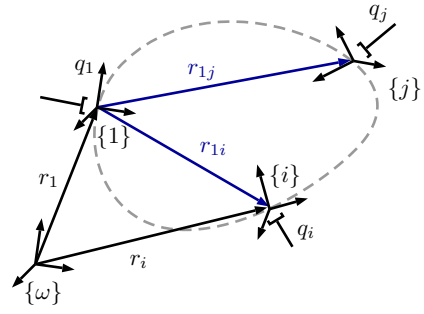

Fig. 2. Reduced end effectors system consisting in the manipulators.

Theorem 3. *Let $\Delta r = [r_{12}^T, \dots, r_{1N}^T]^T$ (with $r_{1i} = r_1 - r_i$ the distance between the 1st and the i -th end effector for $i \in \{2, \dots, N\}$) and the formation maintaining wrenches h^{int}*

$$h^{int} = \bar{A}^T (\bar{A}M^{-1}\bar{A}^T)^{-1} (\bar{b} - \bar{A}M^{-1}\bar{h}^\Sigma) \in \mathbb{R}^{6N} \quad (23a)$$

$$\bar{A} = [-G(\Delta r)^T \quad | \quad I_{6(N-1)}] \in \mathbb{R}^{6(N-1) \times 6N} \quad (23b)$$

$$\bar{b} = [(S(\omega_o)^2 r_{21})^T \quad 0_{1 \times 3} \quad \dots \quad (S(\omega_o)^2 r_{N1})^T \quad 0_{1 \times 3}]^T \in \mathbb{R}^{6(N-1)}, \quad (23c)$$

which arise in the end effectors system subject to the non-interaction wrenches \bar{h}^Σ . Then h^{int} are internal in the sense of Definition 1 and $\text{Ker}(G) \equiv \text{Im}(\bar{A}^T)$.

Proof. First we prove the equivalence $\text{Ker}(G) \equiv \text{Im}(\bar{A}^T)$. It is sufficient to show that (i) the dimensions of $\text{Ker}(G)$ and $\text{Im}(\bar{A}^T)$ coincide and (ii) the following equation holds

$$G\bar{A}^T = 0_{6 \times 6(N-1)}. \quad (24)$$

The first condition is trivial to verify, in fact from the fundamental theorem of algebra we have that $\dim(\text{Im}(\bar{A}^T)) = 6(N-1)$ and $\dim(\text{Ker}(G)) = 6N - \dim(\text{Im}(G)) = 6(N-1)$. In order to prove the second condition we expand (24) obtaining

$$\begin{aligned} \underbrace{\begin{bmatrix} I_3 & 0_3 & I_3 & 0_3 & \dots & I_3 & 0_3 \\ S(r_{12}) & I_3 & S(r_{12}) & I_3 & \dots & S(r_{1N}) & I_3 \end{bmatrix}}_G \underbrace{\begin{bmatrix} \bar{A}^T \\ \vdots \\ I_3 & 0_3 \\ \vdots \\ I_3 & 0_3 \end{bmatrix}}_{\bar{A}^T} &= \\ \begin{bmatrix} -I_3 & 0_3 & \dots & -I_3 & 0_3 \\ S(r_{12}) - I_3 & \dots & S(r_{1N}) - I_3 \\ \vdots & & \vdots \\ -S(r_1) + S(r_{12}) + S(r_2) & -I_3 + I_3 & \dots & -S(r_1) + S(r_{1N}) + S(r_N) & -I_3 + I_3 \end{bmatrix} \end{aligned}$$

and recalling that $S(r_{1i}) = S(r_1) - S(r_i)$, $\forall i = 2, \dots, N$ yields (24).

As stated in [7], equation (23a) results by applying Gauss' principle of least constraints to the end effectors system in Fig. 2 subject to the constraints $\bar{A}\dot{x} = \bar{b}$, with \bar{A} and \bar{b} as in (23). To prove that the wrenches in (23a) are internal in the sense of Definition 1, it is sufficient to show, according to Theorem 2, that $h^{int} \in \text{Ker}(G)$. This comes trivially by multiplying G and h^{int} keeping in mind the result in (24), i.e.

$$Gh^{int} = \underbrace{G\bar{A}^T}_{0_{6 \times 6(N-1)}} (\bar{A}M^{-1}\bar{A}^T)^{-1} (\bar{b} - \bar{A}M^{-1}\bar{h}^\Sigma), \quad (25)$$

therefore $h^{\text{int}} \in \text{Ker}(G)$. \square

Lemma 2. *If the non-interaction wrenches \bar{h}^Σ make the manipulators move with an acceleration compatible with the constraints (3b), then they do not induce any internal wrench.*

Proof. We write the non-interaction wrenches $\bar{h}^\Sigma = M\ddot{x} = M(G^T \ddot{x}_o + b)$, since by assumption they make the manipulators move with accelerations \ddot{x} compatible with the constraints (3b). We substitute them in (23a), yielding

$$h^{\text{int}} = \bar{A}^T (\bar{A}M^{-1}\bar{A}^T)^{-1} (\bar{b} - \bar{A}(G^T \ddot{x}_o + b)). \quad (26)$$

We know from (24) that $G\bar{A}^T = (\bar{A}G^T)^T = 0_{6 \times 6(N-1)}$, therefore $\bar{A}G^T = 0_{6(N-1) \times 6}$. Moreover, it is easy to see that $\bar{A}b = \bar{b}$. Substituting these results in (26) yields $h^{\text{int}} = 0_{6N \times 1}$. \square

Notice that the overall interaction wrenches h are the sum of the external (motion-inducing) wrenches h^{ext} and the internal ones, namely $h = h^{\text{ext}} + h^{\text{int}}$.

III. DECOUPLING CONTROL

The control scheme proposed in [7] is based on an impedance control law to obtain the compliant behavior of the end effectors. We add to this scheme an allocator that makes the internal wrenches h^{int} coincide with desired ones $h^{\text{int},d}$, so that the impedance control still achieves the tracking of $x_o^d, \dot{x}_o^d, \ddot{x}_o^d$, in a fully decoupled way. In Fig. 3 the overall proposed control scheme is depicted.

A. Motion-Inducing Wrenches Control

Following [7], each of the N manipulators is individually controlled by an impedance control law, which renders the end effectors compliant according to

$$M_i(x_i)[\ddot{x}_i - \ddot{x}_i^d] + D_i(x_i, \dot{x}_i)[\dot{x}_i - \dot{x}_i^d] + h_i^K(x_i, x_i^d) = h_i + h_i^d. \quad (27)$$

The impedance parameters matrices $M_i(x), D_i(x_i, \dot{x}_i) \in \mathbb{R}^{6 \times 6}$ represent the apparent mass and damping of the i -th manipulator. They are uniformly positive definite matrices and exhibit a block diagonal structure to decouple the translational and the rotational effects, namely $M_i = \text{blkdiag}(m_i I_3, J_i)$ and $D_i = \text{blkdiag}(d_i I_3, \delta_i I_3)$. The term $h_i^K(x_i, x_i^d)$ represents the geometrically consistent translational and rotational stiffness [12], id est

$$h_i^K(x_i, x_i^d) = \begin{bmatrix} (k_i I_3) \Delta p_i \\ (2\Delta \eta_i \kappa_i I_3) \Delta \epsilon_i \end{bmatrix},$$

where the relative position is $\Delta p_i = p_i - p_i^d$ and the relative orientation is $\Delta q_i = [\Delta \eta_i, \Delta \epsilon_i^T]^T$. The terms $k_i, \kappa_i \in \mathbb{R}^+$ denote the impedance translational and rotational stiffnesses.

Inspired by [7], we rewrite (27) as

$$M(x)\ddot{x} = \overbrace{h^x + h^d}^{\triangleq h^\Sigma} + h \quad (28)$$

where $h^x = M(x)\ddot{x}^d - D(x, \dot{x})[\dot{x} - \dot{x}^d] - h^K(x, x^d)$ represents the wrenches involved in the local end effectors dynamics. The matrices $M(x)$ and $D(x, \dot{x})$ are block diagonal matrices and have respectively on their diagonal the terms $M_i(x)$ and

$D_i(x, \dot{x})$. In the nominal case $h^x = M(x)\ddot{x}^d$ denotes the wrenches needed to obtain the desired acceleration \ddot{x}^d of the manipulators according to (3b). The desired end effectors wrenches h^d can be obtained by distributing the desired object wrench h_o^d among the manipulators with a load distribution strategy. The term h denote the interaction wrenches. Notice that we have defined the non-interaction wrenches $h^\Sigma = h^x + h^d$, consistent with the formulation in (6). The stability of this system (without the allocator) has been already proven in [7, Th. 3-4] and is based on the fact that the system of the object and the manipulators is strictly output passive [7, Lemma 1].

B. Internal Wrenches Control

The choice of the time-varying reference value $h^{\text{int},d}$ for the internal wrenches has a pivotal importance in the formulation of the control law.

Proposition 1. *The reference internal wrenches $h^{\text{int},d}$ must satisfy $h^{\text{int},d} \in \text{Ker}(G)$, or equivalently $h^{\text{int},d} \in \text{Im}(\bar{A}^T)$ (see Theorem 3). Thus we can write $h^{\text{int},d}$ as*

$$h^{\text{int},d} = \bar{A}^T z \quad (29)$$

for a suitable vector $z \in \mathbb{R}^{6(N-1)}$. Note also that the grasp matrix G is constant in the object reference frame $\{o\}$, thus we choose first ${}^o h^{\text{int},d}$ in the object reference frame where $\text{Ker}(G)$ is constant and then we transform each of its N components in the world reference frame $\{w\}$, namely $h_i^{\text{int},d} = \text{blkdiag}({}^w R_o(q_o), {}^w R_o(q_o)) {}^o h_i^{\text{int},d}$, for all i .

The control of the internal wrenches is achieved by means of the following decoupling control law.

Theorem 4. *The control signal*

$$h_w^x = \bar{A}^T (\bar{A}M^{-1}\bar{A}^T)^{-1} (-\bar{A}M^{-1}h^{\text{int},d} + v) \quad (30)$$

where $v = \bar{b} - \bar{A}M^{-1}h^x$ makes the internal wrenches h^{int} coincide with the desired reference $h^{\text{int},d}$. Moreover h_w^x does not affect the interaction dynamics (12) and the stability properties of the closed-loop system still holds.

Proof. First inspect the internal wrenches in (23a) replacing $\bar{h}^\Sigma = h^x + h_w^x$ as depicted in Fig. 3 and obtain

$$\begin{aligned} h^{\text{int}} &= \bar{A}^T (\bar{A}M^{-1}\bar{A}^T)^{-1} \left(\overbrace{\bar{b} - \bar{A}M^{-1}h^x}^v + \right. \\ &\quad \left. - \bar{A}M^{-1}\bar{A}^T (\bar{A}M^{-1}\bar{A}^T)^{-1} (-\bar{A}M^{-1}h^{\text{int},d} + v) \right) \\ &= \bar{A}^T (\bar{A}M^{-1}\bar{A}^T)^{-1} (v - v + \bar{A}M^{-1}h^{\text{int},d}) \\ &= \bar{A}^T (\bar{A}M^{-1}\bar{A}^T)^{-1} \bar{A}M^{-1}h^{\text{int},d} \end{aligned}$$

and knowing that, as stated in Proposition 1, the reference $h^{\text{int},d}$ can be written as $h^{\text{int},d} = \bar{A}^T z$ for a suitable function z , we finally get:

$$\begin{aligned} h^{\text{int}} &= \bar{A}^T (\bar{A}M^{-1}\bar{A}^T)^{-1} \bar{A}M^{-1}\bar{A}^T z \\ &= \bar{A}^T z = h^{\text{int},d}, \end{aligned}$$

therefore we have shown that the control law in (30) makes the internal wrenches h^{int} coincide with the reference $h^{\text{int},d}$. To

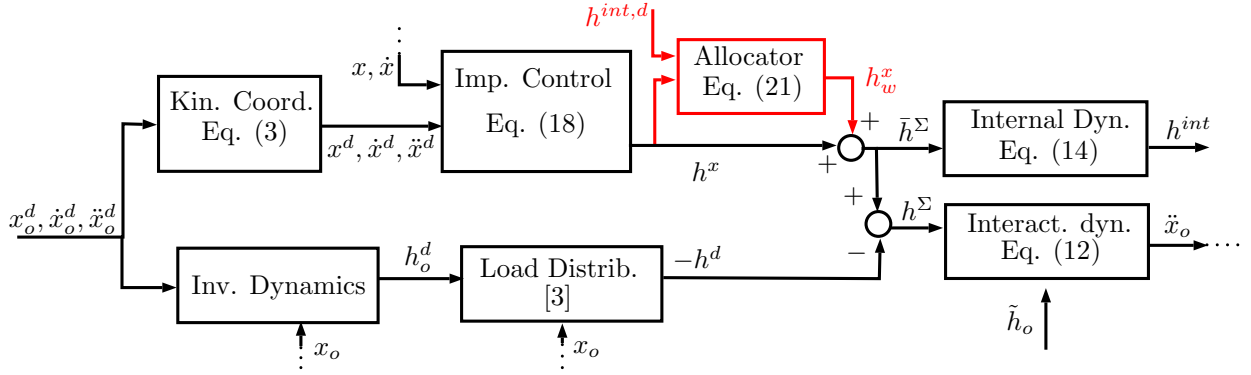

Fig. 3. Overall control scheme: impedance control for motion-inducing wrenches and static allocator (in red) for internal wrenches.

prove that the interaction dynamics is not affected by h_w^x we substitute $h^\Sigma = h^x + h_w^x + h^d$ in (12) and get

$$\ddot{x}_o = \mathcal{M}^{-1}(h_o^\Sigma + G(h^x + h_w^x + h^d) - \tilde{b}).$$

Recalling the expression of h_w^x in (30) we know, from Theorem 3, that $Gh_w^x = 0_{6 \times 1}$, therefore h_w^x does not alter the acceleration of the manipulated object \ddot{x}_o . Thanks to this property, we can infer that the control signal h_w^x does not affect the stability properties of the system addressed in [7]. \square

IV. EXAMPLE

In this section we illustrate the results obtained by means of an example. We analyze a rigid bar grasped by two cooperative manipulators independently controlled, accordingly to the control scheme in Fig 3. The coordinate systems adopted are the ones depicted in Fig. 4. The end effectors have coordinates ${}^o r_{1/2} = [0, 0, \pm 0.40]^T$ m in the object reference frame $\{o\}$. The bar has mass $m_o = 1.75$ kg and inertia $J_{o,x} = J_{o,y} = 0.055$ kgm² and $J_{o,z} = 10^{-5}$ Kgm². The

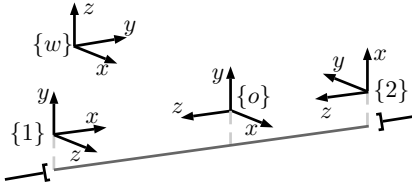

Fig. 4. Coordinate systems involved in the simulation.

impedance inertial parameters for both manipulators are $m_i = 10$ Kg, $J_i = 0.5$ Kgm², the impedance damping parameters are $d_i = 180 \frac{Ns}{m}$ and $\delta_i = 10 \frac{Nm s}{rad}$ and finally the impedance translational and rotational stiffnesses are $k_i = 300 \frac{N}{m}$ and $\kappa_i = 50 \frac{Nm}{rad}$.

We want the object to follow the trajectory depicted in Fig. 5. The bar is lifted up along the z -axis and rotated about the same axis in the world reference frame $\{w\}$. A disturbance wrench $\tilde{h}_o = 10[1, 1, 0, 0, 0, 0]^T$ N in the world reference frame $\{w\}$ acts on the object. At the same time a load cycle of traction and compression is applied by the manipulators to the bar as indicated in Fig. 6. As expected, the static allocator makes

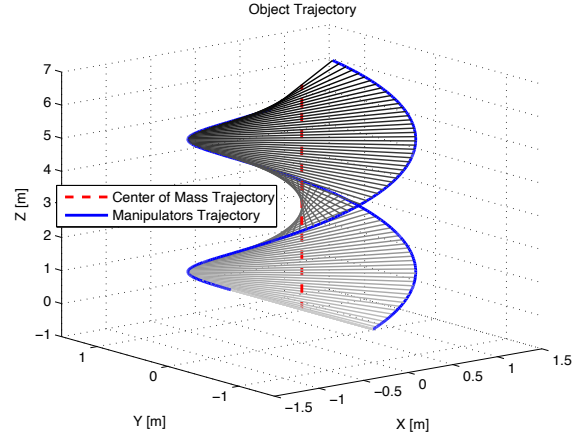

Fig. 5. Trajectory of the object center of mass and of the manipulators.

the actual internal wrenches (solid lines) perfectly coincide with the desired time-varying reference (dashed lines). It can

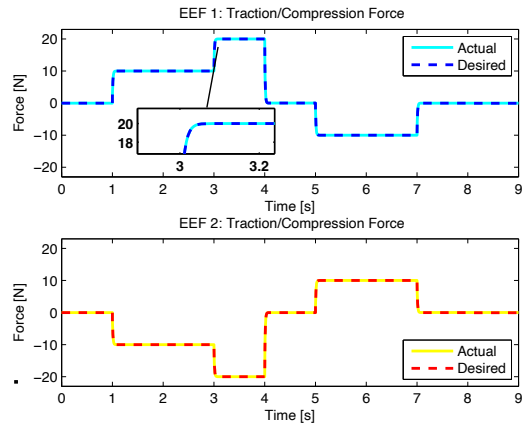

Fig. 6. Load cycle of traction and compression exerted by the manipulators along the z -axes of the object.

be seen from Fig. 7 that the object follows very well the desired trajectory and the actual velocities and accelerations correspond to the reference ones, regardless of the internal

wrenches applied to it. Thus we have shown that our control approach allows to independently control the motion-inducing wrenches (necessary to obtain the desired motion of the object) and the internal wrenches exerted by the manipulators in a fully decoupled manner. This simple academic simulation

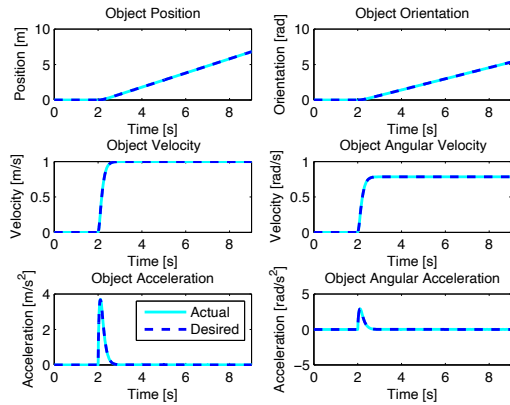

Fig. 7. Translational and rotational position, velocity and accelerations of the object center of mass along and about the world z -axes.

illustrates properly the effectiveness of our control approach. We have shown that the motion of the object is not affected by the application of internal wrenches and, vice versa, internal wrenches follow the desired setpoint independently of the motion-inducing wrenches.

V. CONCLUSIONS AND FUTURE WORK

In this paper we design a control scheme able to achieve the tracking of the motion-inducing and the internal wrenches involved in a cooperative manipulators setup, in a fully decoupled way. This result is based on a physically and mathematically consistent characterization of the interaction dynamics and of the internal wrenches. An impedance control law is used to achieve the compliant behavior of the end effectors, while a static allocator make the internal wrenches coincide with the desired reference, without affecting the motion of the object. Future developments of this paper include an experimental evaluation of the proposed technique.

ACKNOWLEDGMENT

T

This work was supported in parts by the German Research Foundation (DFG) within the Joint Sino-German research project “Control and Optimization for Event-triggered Networked Autonomous Multi-agent Systems (COVEMAS)” and ANR grant “HANDY” (number ANR-18-CE40-0010).

REFERENCES

- [1] T. E. Alberts, D. Soloway, *et al.*, “Force control of a multi-arm robot system,” in *Robotics and Automation, 1988. Proceedings., 1988 IEEE International Conference on*, pp. 1490–1496, IEEE, 1988.
- [2] D. Heck, D. Kostic, A. Denasi, and H. Nijmeijer, “Internal and external force-based impedance control for cooperative manipulation,” in *Control Conference (ECC), 2013 European*, pp. 2299–2304, IEEE, 2013.

- [3] S. Erhart and S. Hirche, “Load distribution in cooperative manipulation tasks,” *IEEE Transactions on Robotics*, Manuscript submitted for publication, Submission number 14-0540, 2015. <https://mediatum.ub.tum.de/doc/1271694/1271694.pdf>.
- [4] D. Williams and O. Khatib, “The virtual linkage: A model for internal forces in multi-grasp manipulation,” in *Robotics and Automation, 1993. Proceedings., 1993 IEEE International Conference on*, pp. 1025–1030, IEEE, 1993.
- [5] B. Siciliano and O. Khatib, *Springer handbook of robotics*. Springer Science & Business Media, 2008.
- [6] I. D. Walker, R. A. Freeman, and S. I. Marcus, “Analysis of motion and internal loading of objects grasped by multiple cooperating manipulators,” *The International journal of robotics research*, vol. 10, no. 4, pp. 396–409, 1991.
- [7] S. Erhart and S. Hirche, “Model and analysis of the interaction dynamics in cooperative manipulation tasks,” *IEEE Transactions on Robotics*, Manuscript submitted for publication, Submission number 14-0643, 2015. <https://public.lsr.ei.tum.de/team/erhart/InteractionDynamics.pdf>.
- [8] H. Bruyninckx and O. Khatib, “Gauss’ principle and the dynamics of redundant and constrained manipulators,” in *Robotics and Automation, 2000. Proceedings. ICRA’00. IEEE International Conference on*, vol. 3, pp. 2563–2568, IEEE, 2000.
- [9] V. De Sapio and O. Khatib, “Operational space control of multibody systems with explicit holonomic constraints,” in *Robotics and Automation, 2005. ICRA 2005. Proceedings of the 2005 IEEE International Conference on*, pp. 2950–2956, IEEE, 2005.
- [10] F. E. Udewadia and R. E. Kalaba, “A new perspective on constrained motion,” *Proceedings: Mathematical and Physical Sciences*, pp. 407–410, 1992.
- [11] J. E. Gentle, *Matrix algebra: theory, computations, and applications in statistics*. Springer Science & Business Media, 2007.
- [12] F. Caccavale, P. Chiacchio, A. Marino, and L. Villani, “Six-dof impedance control of dual-arm cooperative manipulators,” *Mechatronics, IEEE/ASME Transactions on*, vol. 13, no. 5, pp. 576–586, 2008.