



HAL
open science

Design and Fabrication of AlGa_N/Ga_N normally-off HEMTs

Daniel Rouly, Josiane Tasselli, Patrick Austin, Karine Isoird, Frédéric Morancho

► **To cite this version:**

Daniel Rouly, Josiane Tasselli, Patrick Austin, Karine Isoird, Frédéric Morancho. Design and Fabrication of AlGa_N/Ga_N normally-off HEMTs. 10th IRP NextPV International workshop, Jan 2023, Toulouse, France. 2023. <hal-03934236>

HAL Id: hal-03934236

<https://laas.hal.science/hal-03934236v1>

Submitted on 11 Jan 2023

HAL is a multi-disciplinary open access archive for the deposit and dissemination of scientific research documents, whether they are published or not. The documents may come from teaching and research institutions in France or abroad, or from public or private research centers.

L'archive ouverte pluridisciplinaire HAL, est destinée au dépôt et à la diffusion de documents scientifiques de niveau recherche, publiés ou non, émanant des établissements d'enseignement et de recherche français ou étrangers, des laboratoires publics ou privés.



HAL Authorization

Wide Band Gap materials for power applications

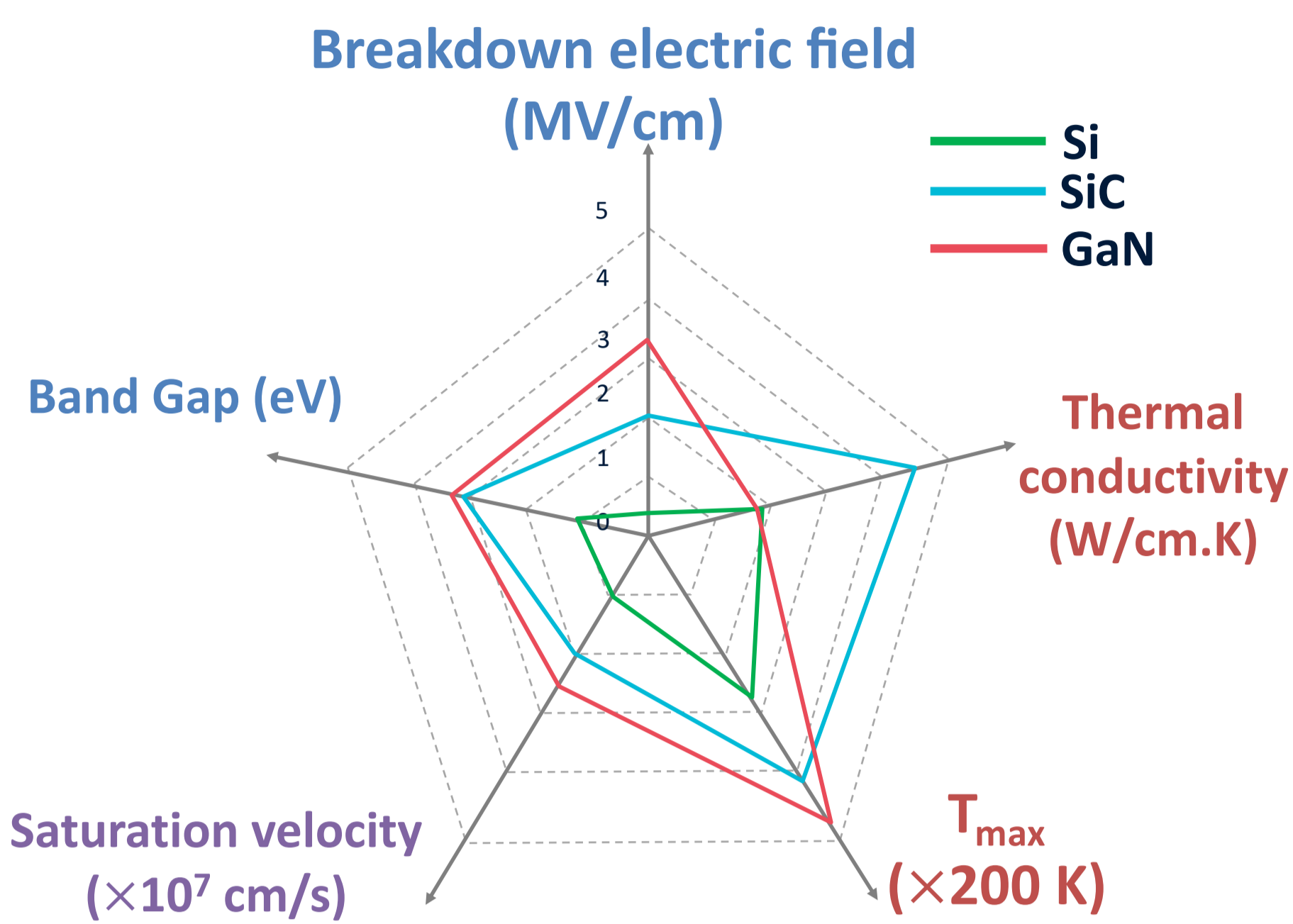

High voltage capability

High operating temperature

High operating frequency

Higher drift velocity at same electric field than silicon

High power density

Energy loss reduction
Better efficiency and space occupation
High power converters for electrical vehicles

GaN material for low (< 200 V) and medium (600 – 900 V) voltage range

Personal electronics

- chargers, adapters, USB PD, ...

Smart Industry

- Telecom, Datacenters, Solar, ...

Car Electrification

- On-board chargers, 400V-12V DC/DC converter
- Traction inverter

The AlGa_{0.2}N/GaN HEMT (High Electron Mobility Transistor): a device of high interest

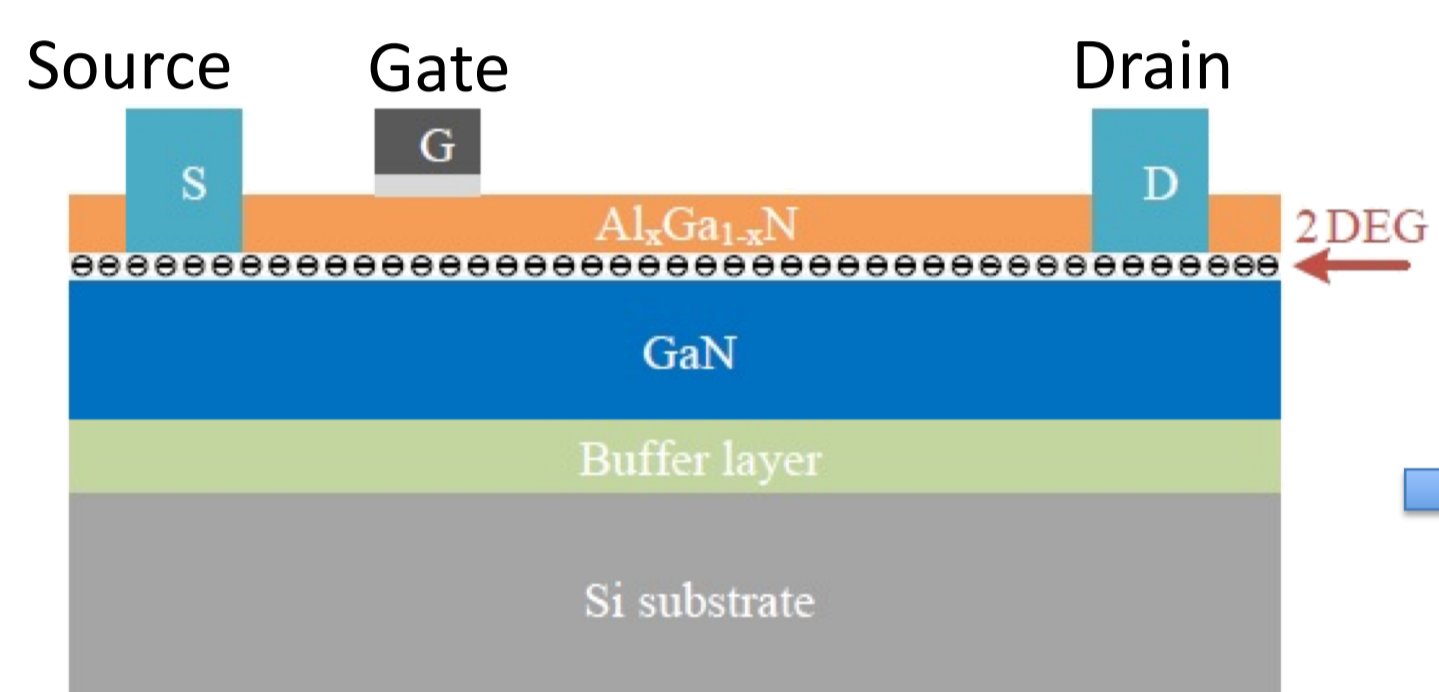

Schema of a conventional normally-on HEMT

😊 Formation of a 2D electron gas (2DEG) at the AlGa_{0.2}N / GaN interface:

- No junction
- High electron mobility (2000 cm²/V.s)
- High breakdown electric field (3 MV/cm)

😞 **Naturally normally-on**
(negative threshold voltage V_{th})

- No compatibility with power architectures
- Only lateral GaN HEMT devices on Si

Technological challenge : Fabrication of Normally-off HEMTs (positive V_{th})

One solution : The recessed P-GaN gate HEMT

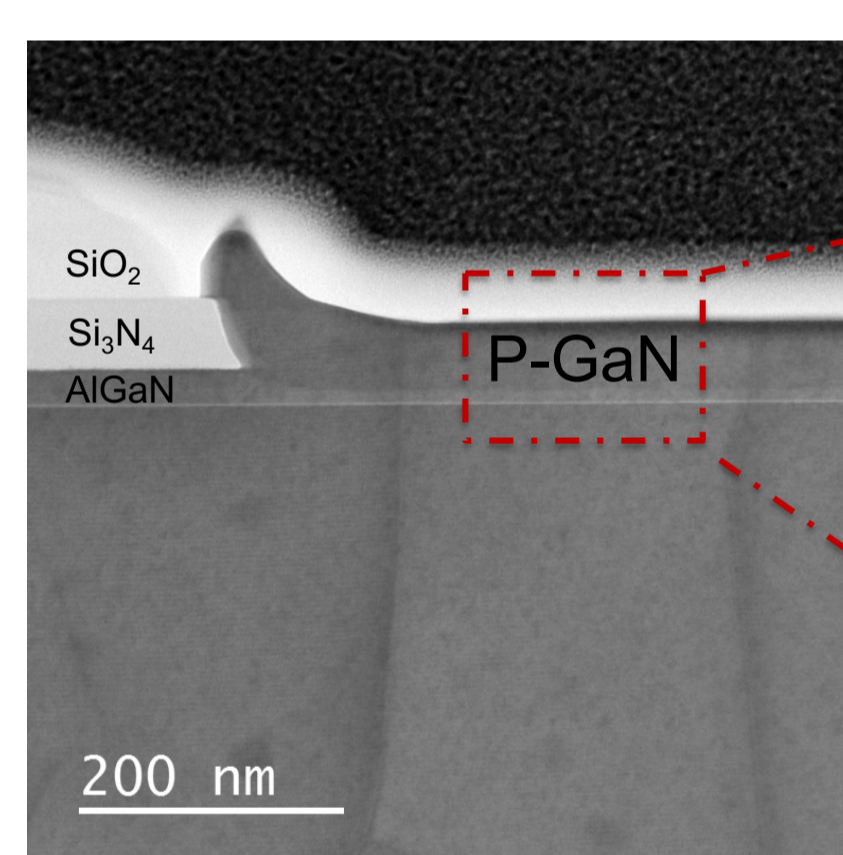
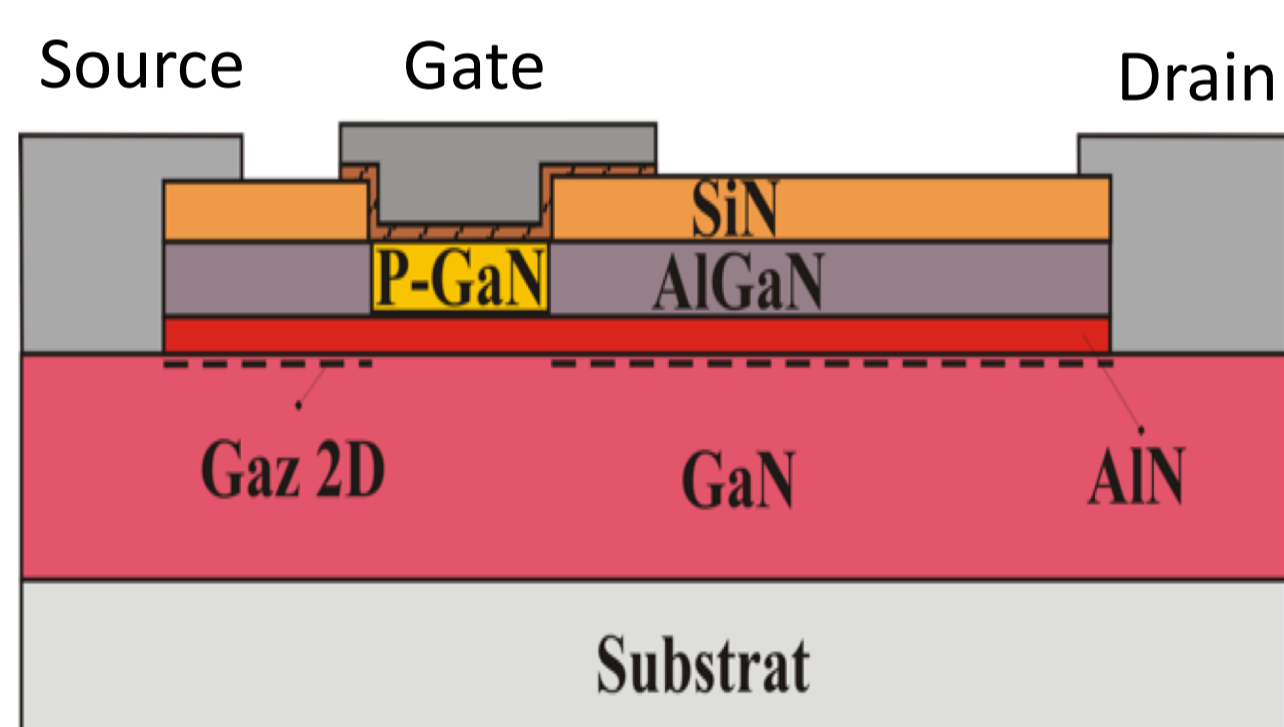

FIB cross-section on the gate after MBE P-GaN regrowth along the whole gate

TEM analysis: Perfect nucleation of GaN on AlGa_{0.2}N etched by RIE

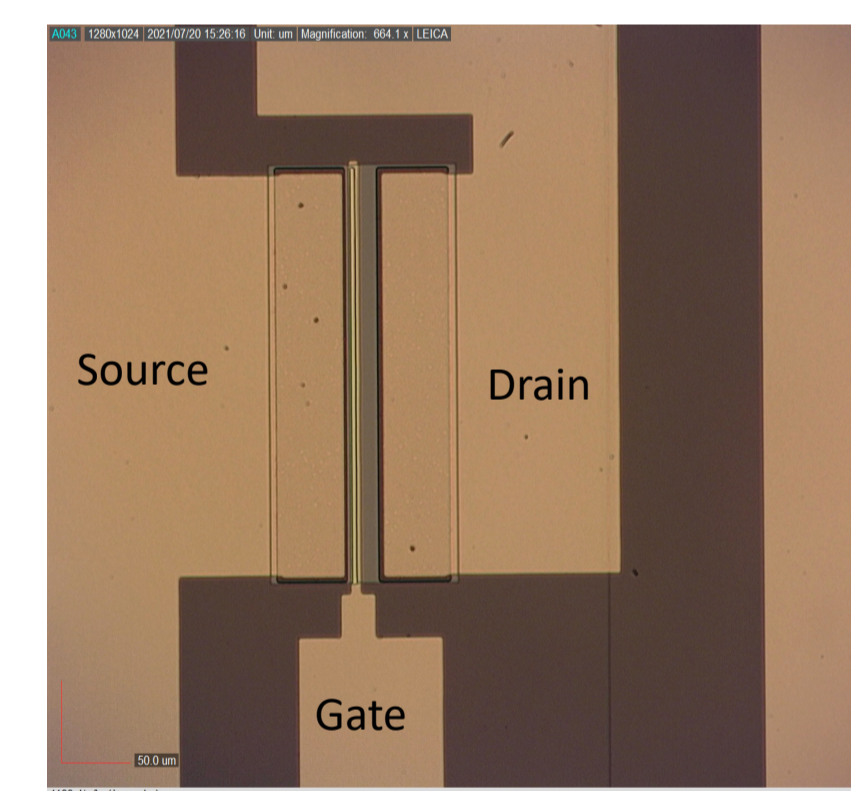

P-GaN gate AlGa_{0.2}N/GaN HEMT fabricated at LAAS

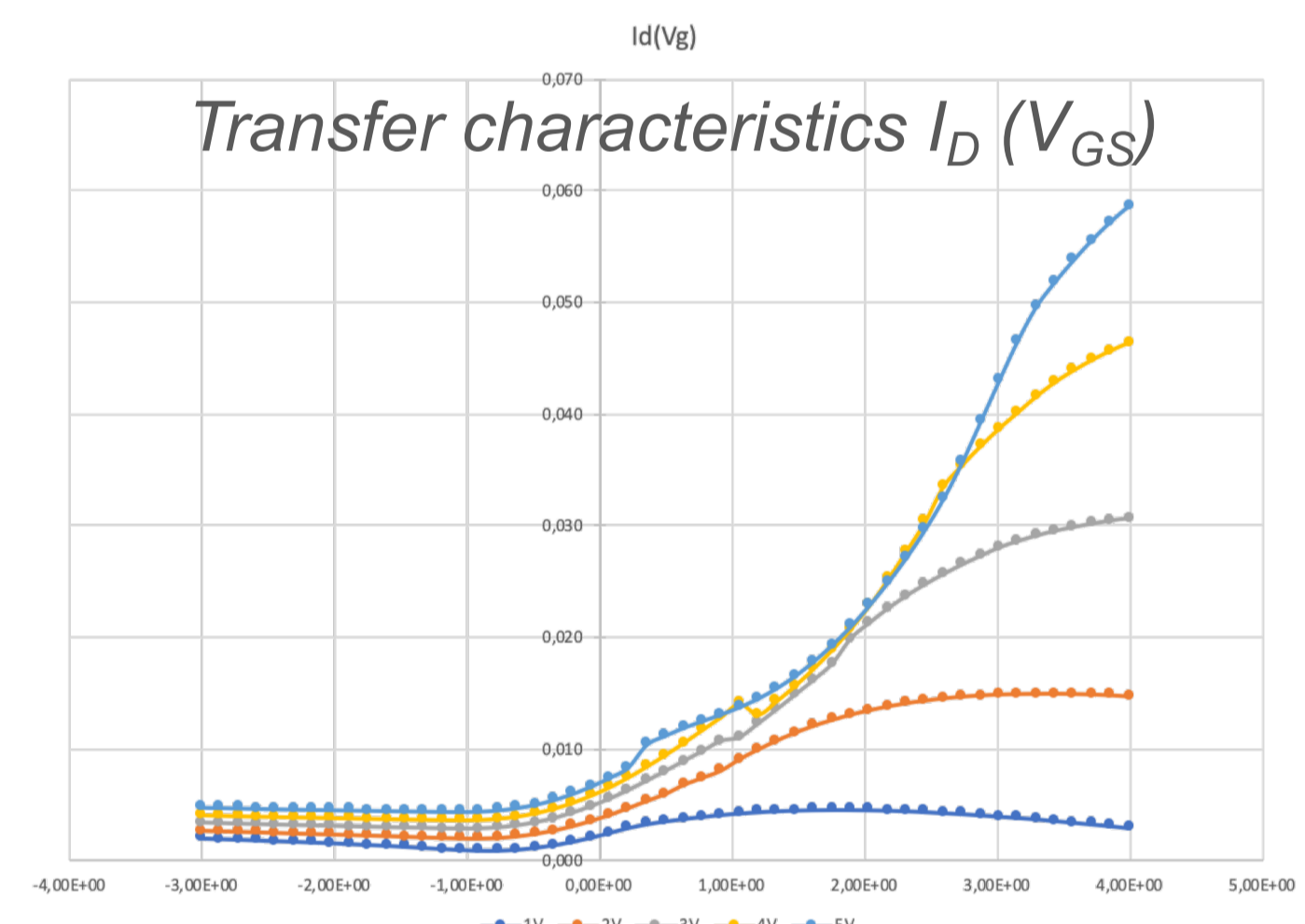

Positive $V_{th} > 1$ Volt → Validation of the P-GaN technology

(G. Toulon & C. Mattew - Patent FR 3 047 609A1)

- ✓ Selective regrowth of Mg-doped GaN through the recessed gate using a SiO₂ mask by molecular beam epitaxy (MBE)
- ✓ Mg doping: 4×10^{18} cm⁻³

A new structure: The nanostructured P-GaN gate HEMT

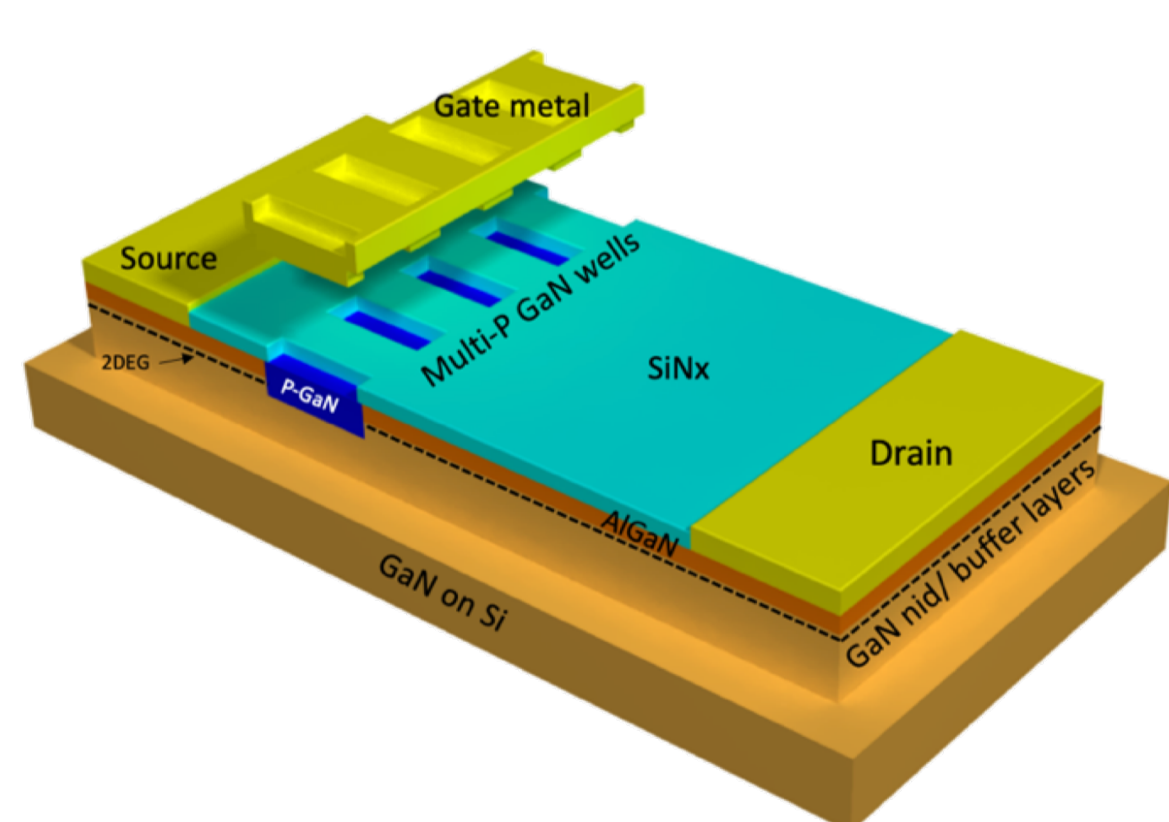

Schematic 3D view of the nanostructured P-GaN wells on the gate

- No degradation of the channel mobility
- Better ionization of Mg doping
- V_{th} control by acting on P-GaN wells parameters (depth, width, spacing, P-doping)
- Technology suitable for power functions integration

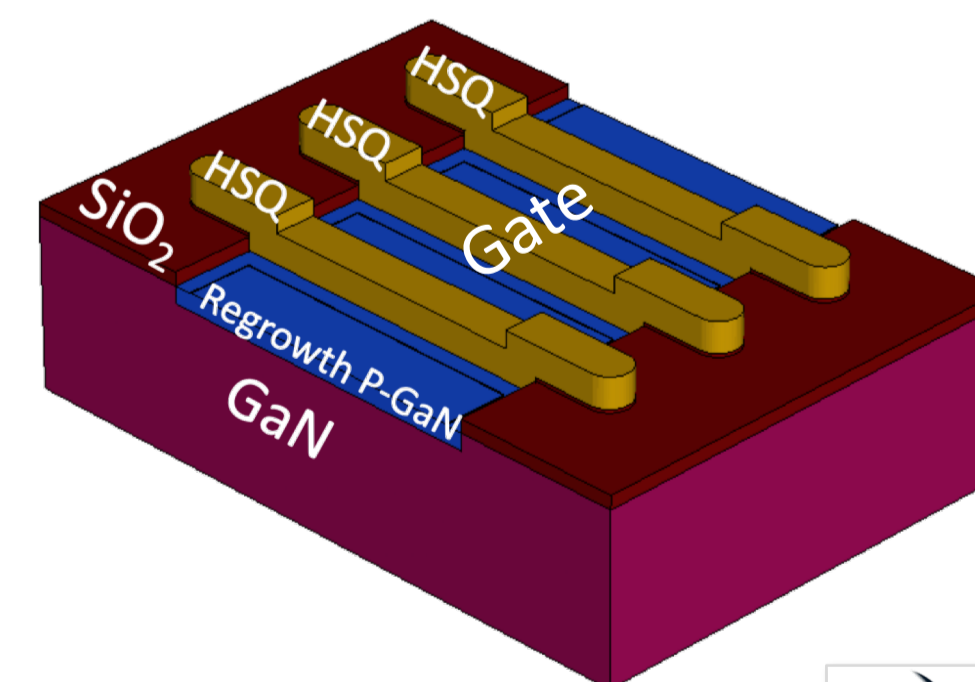

Critical technological steps:

- E-beam lithography of HSQ for the delimitation of P-wells at a nanometric scale (50 - 100 nm)
- Well etching by BCl₃ RIE (150 nm deep)
- MBE Selective area P-GaN regrowth with HSQ mask

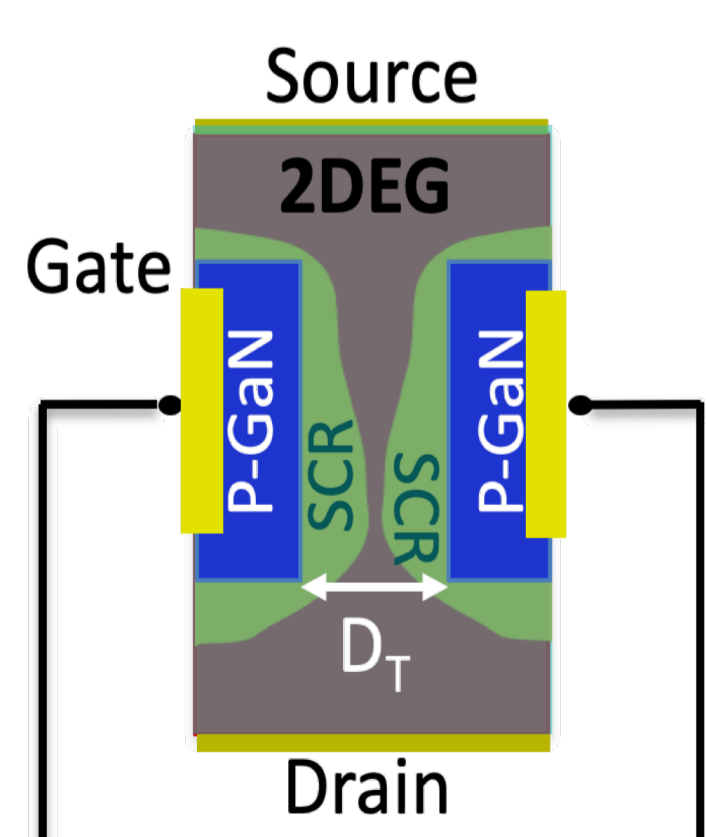

Formation of space charge regions (SCR) between two wells (schematic top view)

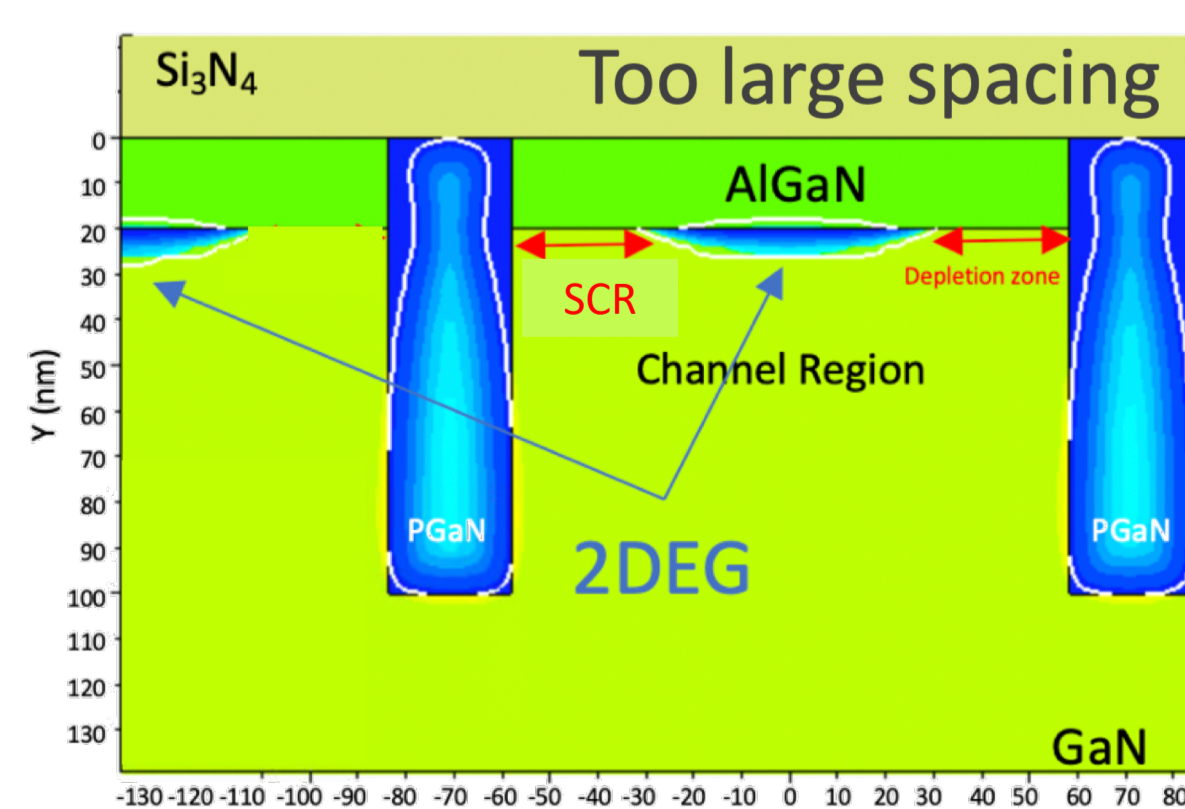

SENTAURUS TCAD simulations: Evaluation of SCR extension between two wells as a function of their spacing

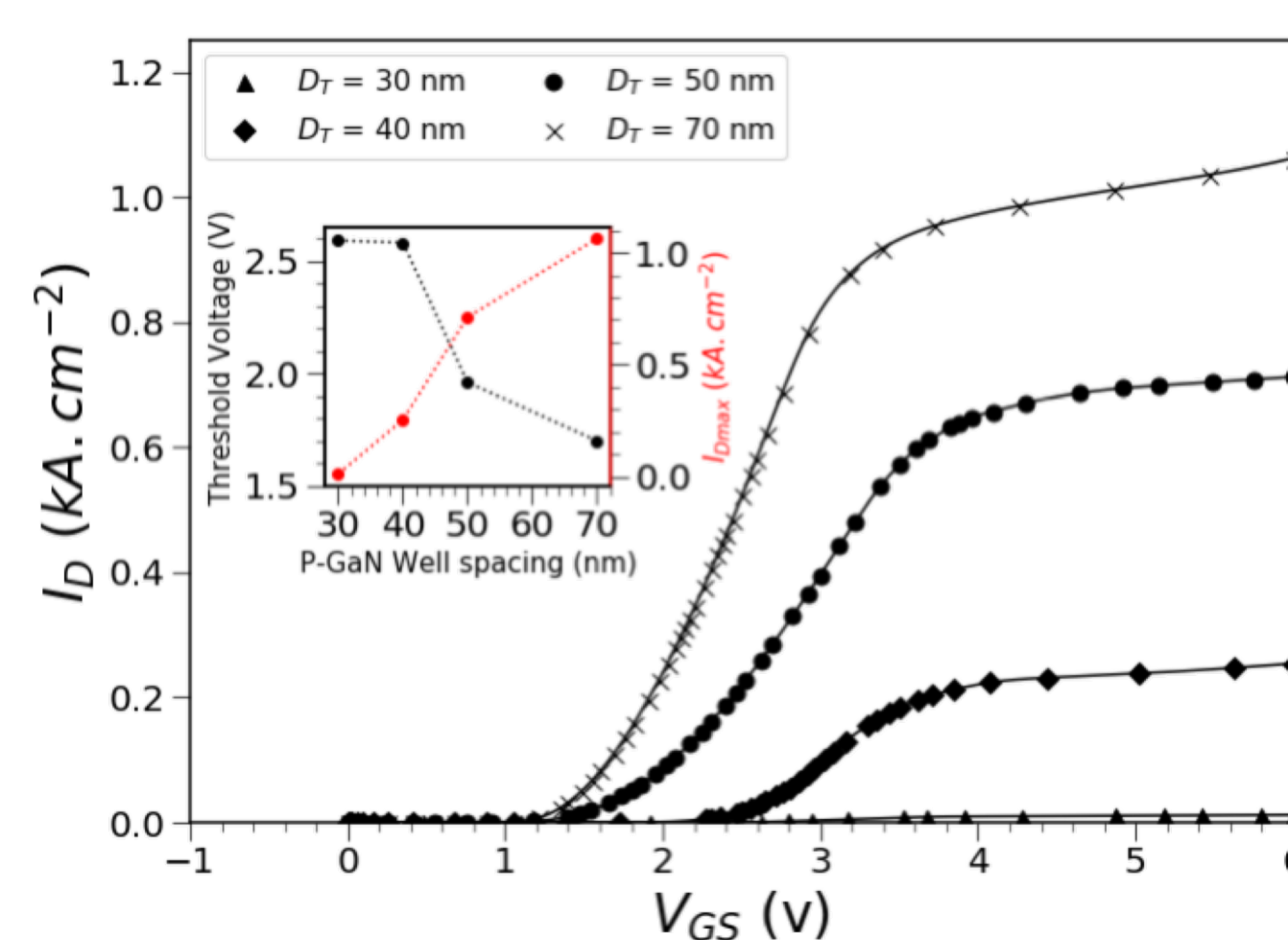

3D simulated transfer characteristics for P-GaN doping of 1.10^{19} cm⁻³:
➢ When spacing increases, threshold voltage decreases
➢ $V_{th} > 1$ V

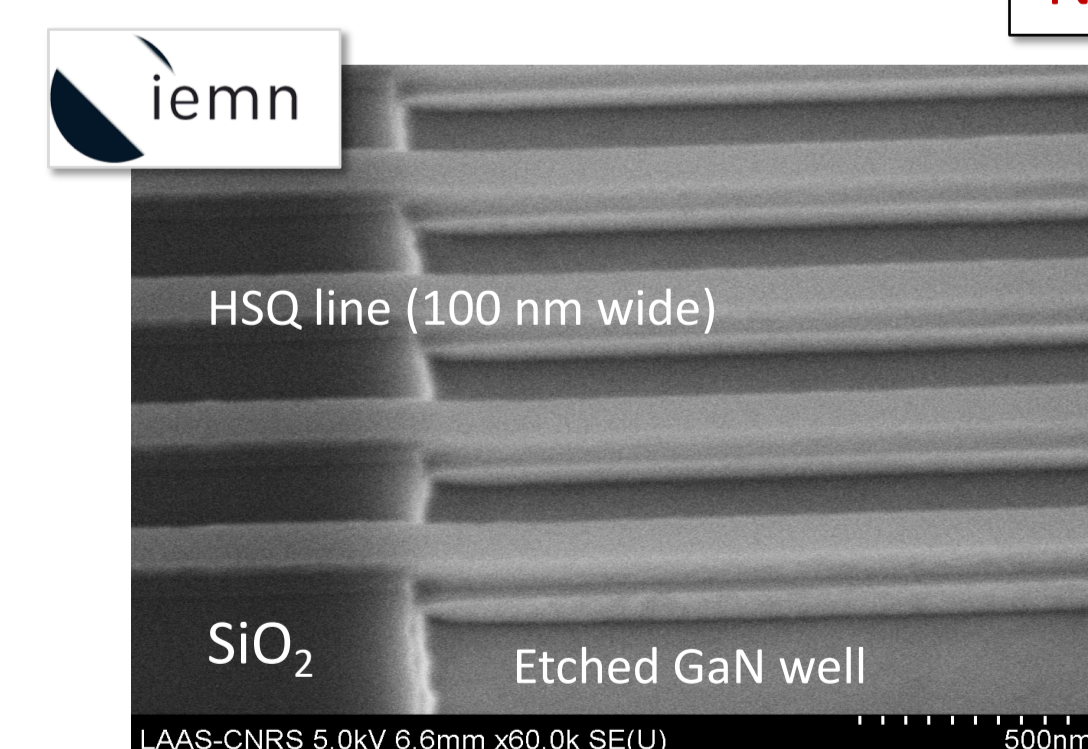

MEB view after HSQ lithography and GaN wells etching

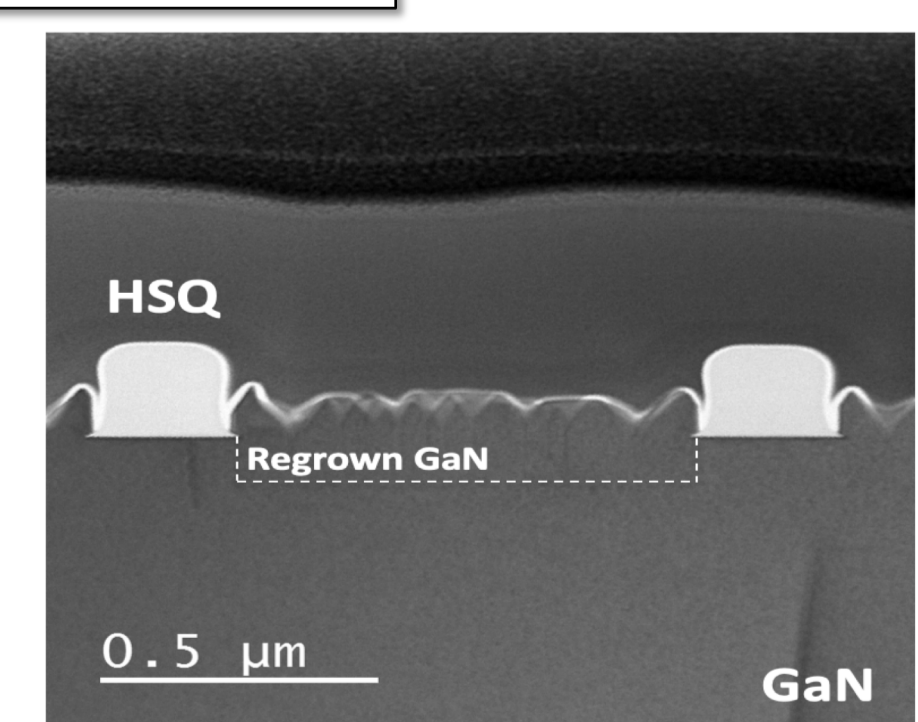

TEM analysis after Nid-GaN regrowth Good crystal quality

Mg doped-GaN regrowth

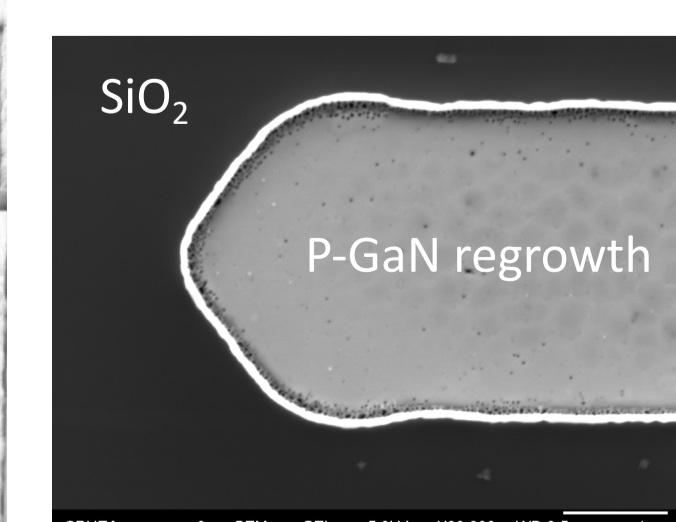
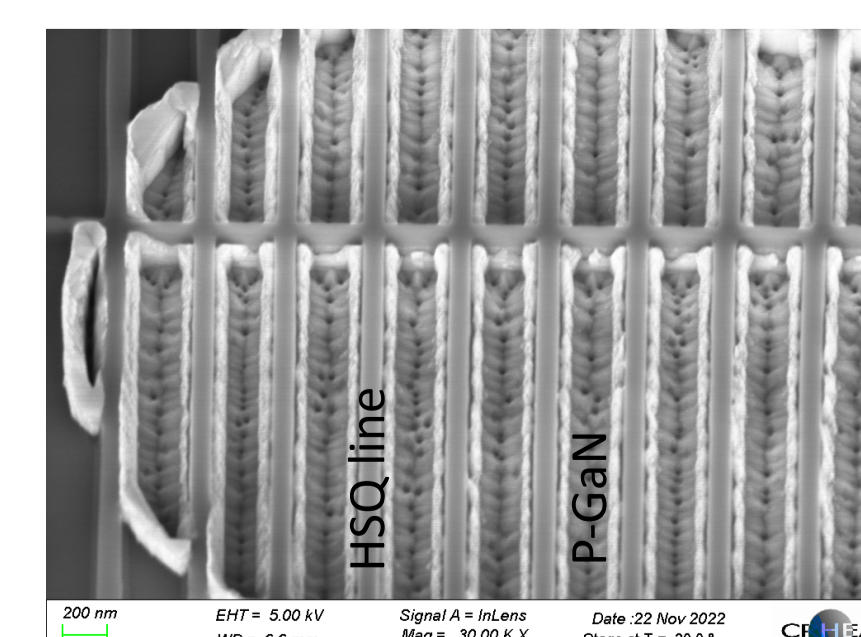

Study under progress for optimizing MBE regrowth parameters in order to fulfill the wells