



**HAL**  
open science

# The Simplified Modeling and Experimental Verification of a Heat Exchanger/Reactor\*

Menglin He, Xue Han, Nathalie Di Miceli Raimondi, Michel Cabassud, Boutaib Dahhou, Lahcen Farhi

## ► To cite this version:

Menglin He, Xue Han, Nathalie Di Miceli Raimondi, Michel Cabassud, Boutaib Dahhou, et al.. The Simplified Modeling and Experimental Verification of a Heat Exchanger/Reactor\*. IEEE 11th International Conference on Systems and Control (ICSC 2023), Dec 2023, Sousse, Tunisia. pp.677-682, <10.1109/ICSC58660.2023.10449866>. <hal-04541196>

**HAL Id: hal-04541196**

**<https://laas.hal.science/hal-04541196v1>**

Submitted on 10 Apr 2024

**HAL** is a multi-disciplinary open access archive for the deposit and dissemination of scientific research documents, whether they are published or not. The documents may come from teaching and research institutions in France or abroad, or from public or private research centers.

L'archive ouverte pluridisciplinaire **HAL**, est destinée au dépôt et à la diffusion de documents scientifiques de niveau recherche, publiés ou non, émanant des établissements d'enseignement et de recherche français ou étrangers, des laboratoires publics ou privés.



HAL Authorization

# The Simplified Modeling and Experimental Verification of a Heat Exchanger/Reactor\*

Menglin HE<sup>1,2</sup>, Xue HAN<sup>3,4</sup>, Nathalie Di Miceli RAIMONDI<sup>2</sup>, Michel CABASSUD<sup>2</sup>,  
Boutaib DAHHOU<sup>5</sup> and Lahcen FARHI<sup>2</sup>

**Abstract**—The heat exchanger/reactor (HEX Reactor) focused in this paper is a device with well-characterized performance on both heat exchanging and chemical reaction parts. A detailed nominal model for this HEX Reactor was established before for the use of further researches in the diagnostic section. However, the detailed model is too complex to bring with difficulties in the design of controllers and the amount of calculations. In this paper, a new simplified interconnected model is developed for the HEX Reactor. The new methodology tries to make full use of the sensors. The interconnected cells in the model are constructed in different sizes according to the locations of the thermocouples. In this way, the total amount of subsystems is evidentially decreased and the nominal model is therefore simplified. A series of experiments in the heat exchange part have been carried out. The experiment data is then compared with that of the simulations on the simplified model. Results show a very high precision of the new model to the physic HEX Reactor.

## I. INTRODUCTION

Process Intensification has garnered significant attention in the field of chemical and pharmaceutical engineering [1] [2]. Its primary objective is to minimize equipment scale and energy usage, simultaneously enhancing process efficiency and safety [3]. In recent years, there has been a surge in the development of compact HEX Reactors in response to the demand for safer, more environmentally friendly, efficient, and energy-efficient processes. These innovations essentially combine unit miniaturization and multifunctionalization of equipment, offering a host of benefits, including enhanced heat transfer performance, improved temperature control, and efficient containment of reactive volumes [4].

The HEX Reactor discussed in this paper is a promising chemical engineering device designed under the concept of process intensification [5]. Its high performances in thermal

and hydrodynamics have been well-characterized in [6]. Its general structure is a combination of a plate heat exchanger and a tubular reactor with piston flow. The apparatus studied in this article consists of three process plates interspersed between four utility plates and separated by plate-walls. After assembling all the units, a compact device is obtained (see Fig. 1). The process fluid flows in a single channel to provide sufficient residence time for the reactants, and in each utility plate, the utility fluid flows in parallel zigzag channels to ensure thermal control of the reaction.

In fact, a detailed model of this reactor was developed in previous work [7]. The modeling process used the parameters of the reactor and the experimental data. In this model, the reactor is divided into 17 computational units, corresponding to the 17 horizontal lines in each process plate (see Fig. 1.a). Each unit contains 15 cells: 3 cells for the process plates, 4 cells for the utility plates, and 8 cells for the walls formed by the closure plates. The model manages all its 255 computing cells strictly adhering to the physical structure and fluid directions. It allows for the representation of the thermal and hydrodynamic behaviors of the reactor and the prediction of the evolution of a chemical reaction along the process channel. Such a detailed, true-to-life model reflects a high level of accuracy as the comparison section described in [7]. The creation of a detailed nominal model has a lot of benefits for further research works on the peripheral system design for the HEX Reactor, such as the process control system, the security system, etc [9] [10] [11]. It is therefore very easy to make tests and simulations on the model than the physics system. However, rather than helping to test the developed peripheral system, the complexity of this model brings difficulties to the section of control algorithm design and implementation. The connected subsystems with more than two hundred individuals in both vertical and horizontal ways make it very hard to show the feedback effect. Therefore, a model with a clear topology and simplified structure is urgently demanded.

This paper shows the new modeling process which takes full use of the sensors of the current system while achieving relatively high accuracy. In section II, we will describe the physical structure of the HEX Reactor and the logic connection in the modeling. We will also present the assumptions that have allowed us to develop a simplified model. Section III gives out the dynamic equations of the model, which provides a satisfactory representation of the reactor's behavior. Experiments and simulations are planned and carried out in section IV. We also make a discussion

\*This research was supported in part by the Agence Nationale de la Recherche (ANR), Project No. ANR-19-CE10-0007-04, France, and Science and Technology Department of Guizhou (Grant No. QKHZC[2023]-345, China)

<sup>1</sup>Menglin HE is with Engineering Practicing Center, Guizhou University, 550025 Guiyang, China mlhel1@gzu.edu.cn

<sup>2</sup>Nathalie Di Miceli RAIMONDI, Michel CABASSUD, Menglin HE and Lahcen FARHI are with LGC, Université de Toulouse, CNRS, INPT, UPS, 31400 Toulouse, France nathalie.raimondi@iut-tlse3.fr, michel.cabassud@toulouse-inp.fr, lahcen.farhi@toulouse-inp.fr

<sup>3</sup>Xue HAN is with AKR, AKKODIS, France xue.han@akkodis.com

<sup>4</sup>Xue HAN is with LIS, UR 7478, University of Caen, ENSICAEN, Caen, France

<sup>5</sup>Boutaib DAHHOU is with LAAS-CNRS, Université de Toulouse, CNRS, INSA, UPS, 31400 Toulouse, France

based on the results. The last section presents a conclusion to the new simplified model.

## II. THE HEX REACTOR AND MODELING METHODOLOGY

The HEX Reactor and its two sub-assemblies are shown in Fig. 1. Two different tubes are curved on both sides of a stainless steel plate. All the tubes are in waves but organized in different ways: the process channel is shaped in a zigzag and connected in serial while the utility channels are more dense and placed in parallel. The stainless plate is defined as plate-wall which functions as the heat-exchange media. A compact reactor shown in Fig. 1 (c) is combined by 3 process plates, 4 utility plates and 8 plate-walls. The HEX Reactor is implemented on the experimental platform and surrounded by insulation materials. Like this, we can neglect the heat exchange between the reactor and the environment. A detailed illustration of the structure could be found in [7].

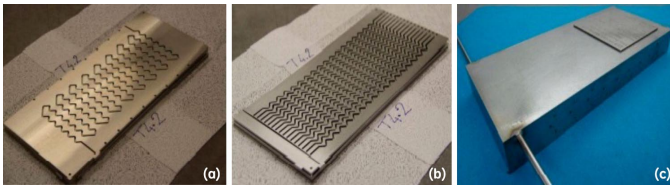

Fig. 1. Physical structure of the HEX Reactor: (a) process plate; (b) utility plate; (c) HEX Reactor after assembly [6]

From a global perspective, we consider the entire reactor as two tubes for the new model. The process tube is surrounded by a wall corresponding to the plate-walls and is located aside another tube through which the utility fluid flows. It is assumed that both the process fluid and the utility fluid flow concurrently in the reactor.

The actual reactor is equipped with 10 thermocouples in total. Two of them are placed at the enter and exit of the utility tube while the other eight are plugged in the process tube as shown in Fig. 2 below:

- One at the entrance of the reactor ( $T_{p\_in}$ ).
- Five are positioned in the first plate (T1, T2, T3, T4, T5).
- One at the beginning of plate 3 (T6).
- One at the exit of the third plate ( $T_{p\_out}$ ).

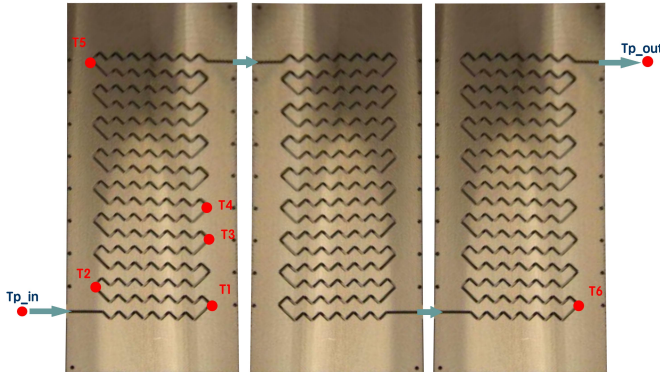

Fig. 2. The process channel and the positions of inner thermocouples

The exact positions (proportion to the total length) of the thermocouples are as follows:

TABLE I  
POSITIONS OF THE THERMOCOUPLES IN THE PROCESS CHANNEL

Sensor	$T_{p\_in}$	T1	T2	T3	T4	T5	T6	$T_{p\_out}$
Position	0	0.022	0.042	0.101	0.140	0.316	0.658	1
Note	Tube enter	Plate 1	Plate 1	Plate 1	Plate 1	End of Plate 1	Enter of Plate 3	Tube exit

In order to obtain a simplified model, the new idea is to divide the whole tube according to the locations of the sensors in the process tube. Like this, the 7 temperatures measured by the thermocouples in the process fluid correspond to the outputs of 7 cascade units with different volumes estimated based on the positions of the thermocouples.

Like before, each unit is composed of 3 perfectly stirred tanks denoted as "k": one process tank, one utility tank, and one wall tank (see Fig. 3). Heat exchanges occur from the process tank to the wall tank and from the utility tank to the wall tank. The process and utility tanks are open, meaning that the fluid enters and exits the tanks. The temperature of a wall tank only changes due to exchanges with the corresponding process and utility tanks (having the same index).

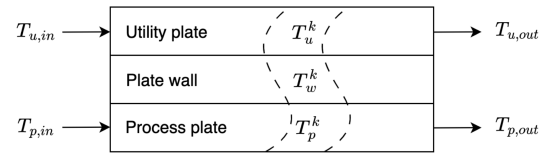

Fig. 3. Structure of the simplified HEX Reactor model with seven units  $k = 1, \dots, 7$  [8]

To account for the differences between the 3 entities (process, utility, wall), the volumes and surfaces are calculated based on the length propositions (see Table II) of each tank.

TABLE II  
RELATIVE UNIT LENGTH OF THE SIMPLIFIED HEX REACTOR MODEL [8]

	Unit 1	Unit 2	Unit 3	Unit 4	Unit 5	Unit 6	Unit 7
$L_k$	0.022	0,020	0.059	0.039	0.176	0.342	0.342

The geometric data of the HEX Reactor are as follows:

- Total length of the process channel is 6.7 meters.
- Total length of the utility channel is 28.525 meters.
- The Mass of the reactor is 10.84 kilograms (made of stainless steel with a density of 8000 kg/m<sup>3</sup>).
- The process channel and the utility channel have a square cross-section of 2 mm by 2 mm.

The volumes and surface areas can be calculated as follows, assuming that the process and utility channels exchange on all 4 sides:

- Volume of the process tank  $V_p^k = L_k * 6.7 * (2 * 10^{-3}) * (2 * 10^{-3}) m^3$
- Surface area for process/wall exchange  $A_p^k = L_k * 6.7 * 4 * (2 * 10^{-3}) m^2$

- Volume of the utility tank  $V_u^k = L_k * 28.525 * (2 * 10^{-3}) * (2 * 10^{-3})m^3$
- Surface area for utility/wall exchange  $A_u^k = L_k * 28.525 * 4 * (2 * 10^{-3})m^2$
- Volume of the wall tank  $V_w^k = L_k * (10.84/8000)m^3$

### III. ENERGY BALANCE BASED MODELING

The model consists of three main parts. The utility and process plates account for hydrodynamics and heat transfer. As for the plate-wall, only heat transfer is considered. To represent the piston-like behavior of the process channel, the tanks are considered perfectly stirred and connected in series. To account for the actual structure of the reactor, the volumes and exchange surfaces of the different tanks are calculated based on the geometry of the HEX Reactor, as previously indicated. The heat exchange modeling is always based on the energy balance of the system.

Thus, for the process unit, we have the following relation:

$$\frac{dT_p^k}{dt} = \frac{F_p^k}{V_p^k}(T_p^{(k-1)} - T_p^k) + \frac{h_p A_p^k}{\rho_p V_p^k C_p^k}(T_w^k - T_p^k) \quad (1)$$

where  $k$  denotes the indication number of the unit;  $h_p(W/m^2/K)$  indicates the heat exchange coefficient between the process cell and the wall cell;  $\rho_p(kg/m^3)$  is the density and  $C_p(J/kg/K)$  the heat capacity of the process fluid.

For the utility unit, the energy balance gives:

$$\frac{dT_u^k}{dt} = \frac{F_u^k}{V_u^k}(T_u^{(k-1)} - T_u^k) + \frac{h_u A_u^k}{\rho_u V_u^k C_p^k}(T_w^k - T_u^k) \quad (2)$$

where  $k$  denotes the indication number of the unit;  $h_u(W/m^2/K)$  indicates the heat exchange coefficient between the utility cell and the wall cell;  $\rho_u(kg/m^3)$  is the density and  $C_p(J/kg/K)$  the heat capacity of utility fluid.

For the wall unit, we have:

$$\frac{dT_w^k}{dt} = \frac{h_p A_p^k}{\rho_w V_w^k C_p^k}(T_p^k - T_w^k) + \frac{h_u A_u^k}{\rho_w V_w^k C_p^k}(T_u^k - T_w^k) \quad (3)$$

where  $k$  denotes the indication number of the unit;  $\rho_w(kg/m^3)$  is the density and  $C_p(J/kg/K)$  the heat capacity of the plate-wall.

To account for the specificity of the heat exchanger reactor with a corrugated channel, heat transfer coefficients  $h$  have been calculated through linear regression using correlations derived from the work of [12]. Two types of correlations have been employed.

The first correlation defines heat transfer coefficients  $h$  according to the linear functions of the fluid's mass flow-rate:

$$h_p = \alpha \times \dot{M}_p \quad (4)$$

$$h_u = \beta \times \dot{M}_u \quad (5)$$

where  $\dot{M}_p$  and  $\dot{M}_u(kg/h)$  denote the mass flow-rate of process and utility fluid respectively.  $\alpha$  and  $\beta$  are two coefficients.

In this relation, the two coefficients are obtained from the linear regression using experimental data. The exact values

are:  $\alpha = 841 (W \cdot m^{-2} \cdot K^{-1} \cdot kg^{-1} \cdot h)$ ,  $\beta = 64 (W \cdot m^{-2} \cdot K^{-1} \cdot kg^{-1} \cdot h)$ .

The second correlation defines heat transfer coefficients  $h$  according to a new linear function of the fluid's mass flow-rate:

$$h_p = \alpha 1 \times \dot{M}_p + \alpha 2 \quad (6)$$

$$h_u = \beta 1 \times \dot{M}_u + \beta 2 \quad (7)$$

where  $\alpha 1$ ,  $\alpha 2$ , and  $\beta 1$ ,  $\beta 2$  are four coefficients.

In this case, the four coefficients obtained from the linear regression using experimental data are:  $\alpha 1 = 577.43 (W \cdot m^{-2} \cdot K^{-1} \cdot kg^{-1} \cdot h)$ ,  $\alpha 2 = 2732.3 (W \cdot m^{-2} \cdot K^{-1} \cdot kg^{-1} \cdot h)$ ,  $\beta 1 = 41.819 (W \cdot m^{-2} \cdot K^{-1})$ ,  $\beta 2 = 2513.3 (W \cdot m^{-2} \cdot K^{-1})$ .

Generally, the second type of correlation is considered to be more reasonable because even if the fluid has no flow-rate, the heat exchange process will still happen and the transfer coefficient will be a non-zero number. Thus, this paper presents the model with the second heat transfer correlation.

By combing equations 1-3, a basic unit is obtained after entering the unique parameters according to the unit length. The entire model is a group of 7 interconnected units. The outputs of the previous unit are the inputs of the former one except that the first unit has an initial input setting, meaning  $T_p^0 = T_{p,in}$ ,  $T_u^0 = T_{u,in}$ . Also, the flow-rates are global inputs which means all the units have the same value as the setting. The model is now easy to implement on Matlab platform and the flowing simulations are made on this platform, too.

### IV. SIMULATION AND EXPERIMENTAL VALIDATION

#### A. Experiment platform

To carry out the experiment, the HEX Reactor is implemented to a platform equipped with pumps, flow-meters, heater, etc. A software platform is developed in LabVIEW environment (see Fig. 4). It also presents the main structure of the experiment system: two pumps inject two kinds of reactants to the process channel of the HEX Reactor while one pump sends utility fluid to the utility channel; flow-rates and temperatures are measured by sensors while commands could be sent to pumps.

The software exchanges the measurements and commands with the physical platform via an NI myDAQ device (see Fig. 5), making the PC a kind of digital twin to the real system. It also has access to exchange data with Matlab platform. So the control and diagnosis applications could be created easily there.

#### B. Experiment Setting

To validate the effectiveness of the simplified model, we made a plan(See Table III) for a series of experiments. The temperature of the utility input, flow-rates of the utility, and process fluids are set to be three independent variables in the plan list. The simulation results are compared to experimental data to validate the accuracy.

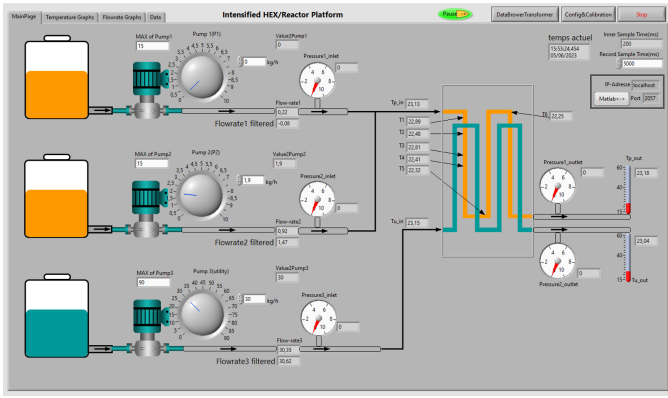

Fig. 4. Measure and Control platform of the HEX Reactor experiment system(Front Page)

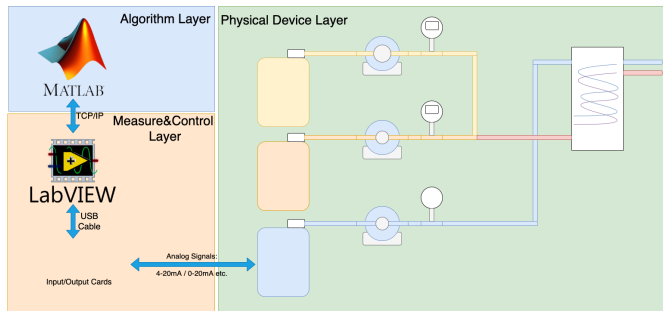

Fig. 5. Logic structure of the experiment system

More than 50 experiments have been carried out. Table III gives the typical 15 experiments in 3 groups containing all ranges of the current parameter setting for the future study.

In Table III, we have 3 different stages of temperature and flow-rate in utility fluid. 5 different flow-rates of process fluid are organized in 3 ways: pump 1 only, pump 2 only and the two work at the same time. Like this, we can also check the inner control loop of the experiment platform: the pump control.

The experiments are carried out in groups. For example, it is easy to notice that the settings of experiment 1-5 are nearly the same except for the changes in the process flow-rate. So, they will be launched in serial. The experiment is

TABLE III  
EXPERIMENT SETTINGS FOR THE VALIDATION

No.	Tp <sub>in</sub>	Tu <sub>in(plan)</sub> °C	Tu <sub>in(actual)</sub> °C	Fu kg/h	Fp1 kg/h	Fp2 kg/h
1			38		1	1
2			37		2	2
3		40	36.3	30	3	3
4			35.8		4	4
5			35.4		5	5
6			57.1		0	2
7	Environment		55.5		0	4
8		60	52.7	60	0	6
9	temperature		51.9		0	8
10			69.2		5	5
11			69.2		2	0
12			67.3		4	0
13		80	65.6	90	6	0
14			64.1		8	0
15			62.9		5	5

always starting at achieving the first balance state, which generally takes around one hour and a half. It means the utility fluid will be cycled first at the given parameter. When the temperature of the output utility fluid is getting stable, the process fluid starts to have the first speed and we note the current time as T0. When the temperature of the output process fluid is getting stable, we note the current time as T1 and change the process flow-rate to the next value. Like this, we will have T2, T3, etc. So, the period between T0 and T1 is defined as experiment 1, the period between T1 and T2 defined as experiment 2, etc. For each experiment, the time duration is set to 20 minutes and it is enough to reach a stable state.

Since the heater for the utility fluid is not connected directly to the reactor and there is some energy loss in the outside tube, the exact temperature of the utility fluid when entering the reactor has difference with the setting. It is not a problem because we use this actual  $Tu_{in}$  for the simulation. Like this, the consistency of each experiment and its simulation is guaranteed. Other inputs for each simulation are the same as the experiment plan in Table III.

### C. Simulation and Experiment Results

Simulations are set to run the same 1200 seconds as the experiment and the sampling time is 5 seconds, too. When the simulation of the simplified model is over, we take the process fluid temperatures of all 7 units and compare them with that of the 7 thermocouples. Normally, the sensor data in the experiment contain some noise. To decrease the misalignment from sensors and the AD process, we use the average of measurements.

Since the HEX Reactor is designed for chemical reactions with energy exchange, temperature is a key index of the process. Therefore, the temperature distribution in the process tube is essential to the chemical engineer and is chosen for comparison in this paper. Experiment 2, 8, 14 and their corresponding simulations are presented in Fig. 6 to 8(With detailed values in Table IV). Since we cannot put the results of all the 15 items here, the chosen ones are typical in each stage of settings. Besides that, the complex model is simulated under the condition of Experiment 9 and the results will be used to evaluate the new model, too.

TABLE IV  
EXPERIMENT SETTINGS FOR THE VALIDATION

Source	Tp <sub>in</sub>	T1	T2	T3	T4	T5	T6	Tp <sub>out</sub>
Exp.2	23.54	29.97	32.42	35.00	35.15	35.93	34.62	35.30
Sim.2	23.54	29.83	32.67	34.76	35.22	35.43	35.45	35.45
Exp.8	22.27	36.17	42.82	49.68	50.72	52.03	50.20	50.97
Sim.8	22.27	35.94	42.78	48.71	50.23	51.06	51.17	51.18
Exp.9	22.18	33.32	39.41	46.72	48.37	50.34	48.19	49.12
Sim.9	22.18	34.09	40.39	46.37	48.03	49.05	49.20	49.21
Sim.9(Comp.)	22.18	32.78	37.63	45.54	47.87	50.62	49.22	49.20
Exp.14	23.96	39.58	48.01	57.82	59.86	61.75	59.84	60.51
Sim.14	23.96	40.28	48.89	57.00	59.22	60.59	60.79	60.80

Fig. 6 is the comparison result of Experiment 2 and its simulation. It shows the reactor's properties in low input temperature and small flow-rates. In the picture, we can notice that the first 4 points are very close. These sensors

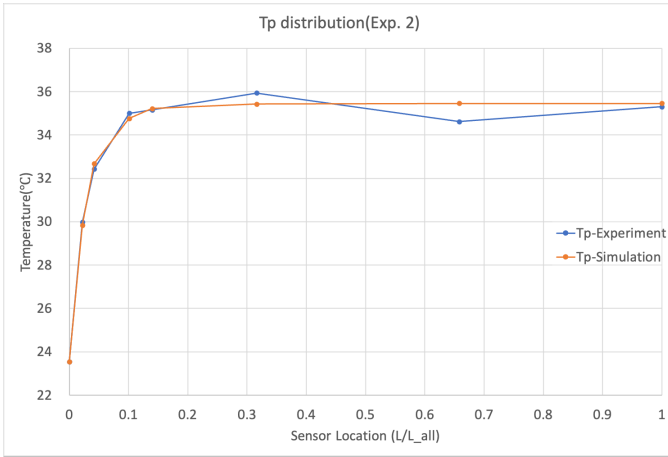

Fig. 6. Results comparison of the model simulation and experiment (No.2)

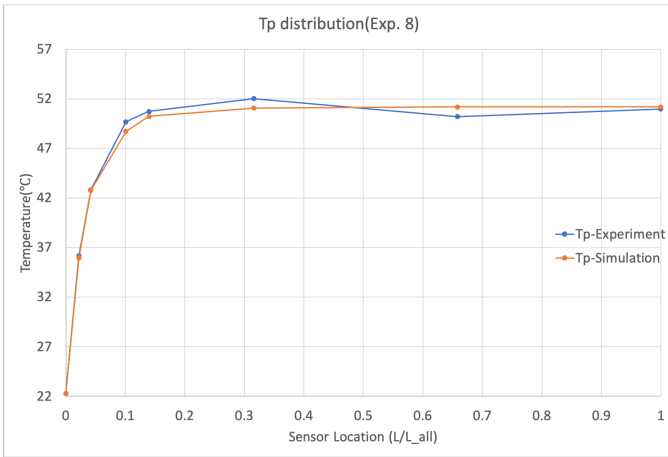

Fig. 7. Results comparison of the model simulation and experiment (No.8)

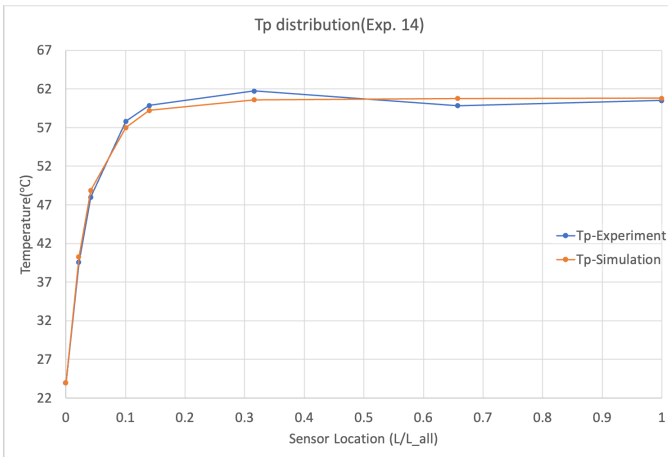

Fig. 8. Results comparison of the model simulation and experiment (No.14)

are in the beginning of the first process plate, which is the area where the fiercest chemical reaction may take place. The model precision in this zone is crucial. After that, we have two points in the middle that have the biggest difference with the experiment. It is because of our new assumptions for the simplification. For the two tubes, the real reactor has concurrent and counter-current situations. The new model neglects the former one and brings this problem. T5 is at the top of the first process plate, which is located just on the next side of the utility input. As we have a higher temperature in the utility fluid, the area around T5 is different from the model. T6 has a similar assumption contradiction which leads to current results. Since the difference is around just one degree and gets smaller as the temperature increases (see Fig. 7 and Fig. 8), it is acceptable for a simplified model. At the last point, we have very close  $T_{p\_out}$  temperatures in both simulation and experiment. The results in Fig. 7 and Fig. 8 show similar trends as in Experiment 2.

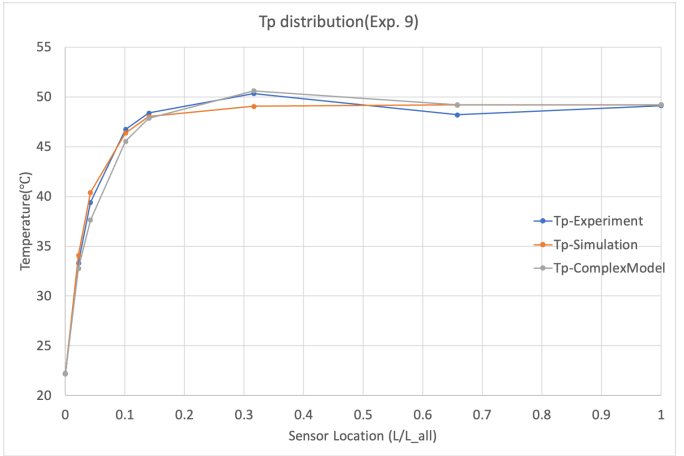

Fig. 9. Simulation results of complex model and simplified model compare with the experiment (No.9)

Fig. 9 shows the simulation results of the complex model and the simplified model, and the experiment measurements at the same parameters. Apparently, the simplified model performs even better at the prediction of the first four points. That is due to the proper use of the heat transfer correlation. As the detailed model developed in [7] reflects accurately the structure and current direction of the physical reactor, it performs better at predicting the two middle points. We can also notice that all three output temperatures are nearly the same. This comparison shows that the newly developed model in this paper is accurate enough and could replace the complex model for future use.

## V. CONCLUSION

This paper presents the simplified modeling works and considers the heat exchange part for a HEX Reactor. Even though the detailed nominal model of this reactor has been developed before, it is too complicated to help the following controller design and diagnosis problems. To solve the contradiction, a simplified nominal model with an ac-

ceptable accuracy should be considered. The new modeling methodology assumes that the reactor is considered to be two concurrent tubes glued by stainless steel for heat exchange. Since the reactor has 6 inner thermocouples in the process channel, it is natural to cut logically the entire reactor according to the location of the sensors. A simplified model is then achieved by interconnecting the 7 sub-units. The benefit is clear that the output of each sub-unit has a reference sensor in the reactor, making it easy to verify the model precision. In the end, experiments and simulations are planned and carried out to check the accuracy. Comparison results show that the prediction accuracy is very high for the sensors at the first plate. The two units corresponding to T5 and T6 are not as accurate to show the real trend due to the simplified assumption. However, the differences are small and around just one degree. The old detailed model is simulated to compare with the new model, too. Indeed, the complex model does better at predicting the overall temperature distribution. However, the simplified model uses 10% complexity to reach a 95% performance in precision, making it a high-quality-price ratio option. Lastly, the output temperature of the model(Tp.out) is always close to the experiment. These discussions suggest the conclusion that the simplified model is good enough for further research.

#### ACKNOWLEDGMENT

The authors acknowledge the Agence Nationale de la Recherche, France(ANR-19-CE10-0007-04) and the Science and Technology Department of Guizhou, China(Grant No. QKHZC[2023]-345).

#### REFERENCES

- [1] J.C. Etchells, Process Intensification: Safety Pros and Cons, *Process Safety and Environmental Protection*, Volume 83, Issue 2, 2005, Pages 85-89, ISSN 0957-5820.
- [2] Juan Gabriel Segovia-Hernández, Salvador Hernández, Enrique Cossio-Vargas, Eduardo Sánchez-Ramírez, Challenges and opportunities in process intensification to achieve the UN's 2030 agenda: Goals 6, 7, 9, 12 and 13, *Chemical Engineering and Processing - Process Intensification*, Volume 192, 2023, 109507, ISSN 0255-2701.
- [3] Xue Han, Rim Rammal, Menglin He, Zetao Li, Michel Cabassud, Boutaib Dahhou, Dynamic and sensor fault tolerant control for an intensified heat-exchanger/reactor, *European Journal of Control*, Volume 69, 2023, 100736, ISSN 0947-3580.
- [4] Hanbin Shi, Nathalie Di Miceli Raimondi, Michel Cabassud, Christophe Gourdon, Experimental study of heat transfer coefficient in heat exchanger reactors with square millimetric zigzag channels, *Chemical Engineering and Processing - Process Intensification*, Volume 182, 2022, 109194, ISSN 0255-2701.
- [5] Z. Anxionnaz, M. Cabassud, C. Gourdon, P. Tochon, Heat exchanger/reactors (HEX reactors): Concepts, technologies: State-of-the-art, *Chemical Engineering and Processing: Process Intensification*, Volume 47, Issue 12, 2008, Pages 2029-2050, ISSN 0255-2701.
- [6] F. Théron, Z. Anxionnaz-Minvielle, M. Cabassud, C. Gourdon, P. Tochon, Characterization of the performances of an innovative heat-exchanger/reactor, *Chemical Engineering and Processing: Process Intensification*, Volume 82, 2014, Pages 30-41, ISSN 0255-2701.
- [7] He M, Li Z, Han X, Cabassud M, Dahhou B. Development of a Numerical Model for a Compact Intensified Heat-Exchanger/Reactor. *Processes*. 2019; 7(7):454. <https://doi.org/10.3390/pr7070454>
- [8] X. Han, M. He, N. D. M. Raimondi, M. Cabassud and B. Dahhou, "Distributed adaptive observer-based Fault Diagnosis for an Intensified Heat Exchanger/Reactor," 2023 31st Mediterranean Conference on Control and Automation (MED), Limassol, Cyprus, 2023, pp. 37-42, doi: 10.1109/MED59994.2023.10185746.

- [9] Zhang, Mei and Dahhou, Boutaieb and Cabassud, Michel and Li, Ze-Tao Actuator fault detection and isolation via input reconstruction: Application to intensified heat exchanger reactor. (2015) In: 2015 23rd Mediterranean Conference on Control and Automation (MED), 16 June 2015 - 19 June 2015 (Torremolinos, Spain)
- [10] He, M.; Li, Z.; Dahhou, B.; Cabassud, M. The Fault Tolerant Control Design of an Intensified Heat-Exchanger/Reactor Using a Two-Layer, Multiple-Model Structure. *Sensors* 2020, 20, 4888.
- [11] Amine Dakkoune, Lamiae Vernières-Hassimi, Dimitri Lefebvre, Lionel Estel, Early detection and diagnosis of thermal runaway reactions using model-based approaches in batch reactors, *Computers and Chemical Engineering*, Volume 140, 2020, 106908, ISSN 0098-1354.
- [12] SHI, H. Etude du transfert de chaleur en canaux millimétriques de type zigzag pour le développement et l'extrapolation de réacteurs-échangeurs compacts. Thèse de doctorat, Toulouse: Université Paul Sabatier, 2019.