



HAL
open science

Contributions to the Stability Analysis and Control of Networked Systems

Alexandre Seuret

► **To cite this version:**

Alexandre Seuret. Contributions to the Stability Analysis and Control of Networked Systems. Automatic Control Engineering. Université Toulouse 3 Paul Sabatier (UT3 Paul Sabatier), 2017. tel-01881095

HAL Id: tel-01881095

<https://laas.hal.science/tel-01881095>

Submitted on 25 Sep 2018

HAL is a multi-disciplinary open access archive for the deposit and dissemination of scientific research documents, whether they are published or not. The documents may come from teaching and research institutions in France or abroad, or from public or private research centers.

L'archive ouverte pluridisciplinaire **HAL**, est destinée au dépôt et à la diffusion de documents scientifiques de niveau recherche, publiés ou non, émanant des établissements d'enseignement et de recherche français ou étrangers, des laboratoires publics ou privés.

MANUSCRIT *présenté pour l'obtention de*

l'Habilitation à Diriger des Recherches

de l'Université Toulouse 3 Paul Sabatier *par*

Alexandre SEURET

LABORATOIRE D'ANALYSE ET D'ARCHITECTURE DES SYSTÈMES

Document de synthèse intitulé :

***“Contributions to the Stability Analysis and Control of
Networked Systems”***

Soutenance le 19 Décembre 2017, devant le jury composé de

Rapporteurs :	Prof. Sandra HIRCHE	Technische Universität München
	Prof. Jean-Michel CORON	Université Pierre et Marie Curie
	Prof. Carsten SCHERER	Universität Stuttgart
Examineurs :	Prof. Jean-Pierre RAYMOND	Université de Toulouse 3, UPS, Toulouse
	Prof. Jamal DAAFOUZ	Université de Lorraine, Nancy
	Prof. Jean-Pierre RICHARD	École Centrale de Lille, Lille
	Dr. Christophe PRIEUR	GIPSA-LAB-CNRS, Grenoble
	Dr. Silviu-Iulian NICULESCU	L2S-CNRS-Centrale-Supélec, Paris
	Dr. Sophie TARBOURIECH	LAAS-CNRS, Toulouse

Contents

Preface	i
Notations	iii
1 General Introduction	1
1.1 Networked Control Systems with limited information	2
1.1.1 Communication delays	3
1.1.2 Time-quantization	4
1.1.3 Space-quantization	4
1.1.4 Distribution and neighboring	5
1.2 Summary of the contributions	5
1.2.1 Time delay systems	5
1.2.2 Robust sampled-data control	6
1.2.3 Event-based control & hybrid dynamical systems	7
1.2.4 Multi-agent and distributed systems	8
1.2.5 Infinite-dimensional systems	10
1.3 Organization of the manuscript	11
2 Time-delay systems	13
2.1 Introduction	14
2.1.1 Particularities of time-delay systems	14
2.1.2 System and delay models	16
2.1.3 Usual assumptions on the delay functions	18
2.2 Stability of time-delay systems using the 2^{nd} Lyapunov Method	20
2.2.1 Second Lyapunov method	20
2.2.2 Lyapunov-Razumikhin approach	20
2.2.3 Lyapunov-Krasovskii approach	22
2.3 Integral inequalities and time-delay systems	25
2.3.1 Jensen's inequality	26
2.3.2 Wirtinger-based integral inequality	26
2.3.3 Extension of the Wirtinger-based inequalities	30
2.3.4 Bessel-Legendre inequality on Hilbert spaces	30
2.4 Application to linear systems with a constant delay	38
2.4.1 Stability theorem	38

2.4.2	Remark on the choice of the Lyapunov-Krasovskii functional	40
2.4.3	Hierarchy of LMI stability conditions	41
2.5	Numerical applications and extensions	43
2.5.1	Linear systems with a single discrete delay	43
2.5.2	Linear systems with multiple discrete delays	46
2.5.3	Linear systems with a distributed delay	47
2.6	Conclusions	48
3	Sampled-data systems	49
3.1	Introduction	49
3.2	Problem formulation and theoretical motivations	50
3.2.1	System data	50
3.2.2	A first stability result	51
3.2.3	An illustrative example	51
3.3	Input delay approach	53
3.3.1	Sampled-data systems modeled as fast-varying delay systems	53
3.3.2	Methodology to derive efficient stability conditions	54
3.3.3	Extensions & Limitations	60
3.4	Stability analysis using Looped-functionals	61
3.4.1	Basics of the Looped-functionals approach	62
3.4.2	Main result on asymptotic stability of sampled-data systems	62
3.4.3	What is a good structure for a looped functional?	64
3.5	Extensions and an emphasis to networked control systems	67
3.5.1	A brief overview of the latter achievements	67
3.5.2	Application to sampled-data dynamic output-feedback control under input saturations	69
3.6	Conclusions	74
4	Conclusions and Perspectives	75
4.1	General conclusion	76
4.2	Further results on sampled-data systems	77
4.2.1	Robust sampled-data control	77
4.2.2	Event-triggered sampled-data control	78
4.3	Stability analysis and control of time-delay systems	82
4.3.1	Stability analysis of time-delay systems	82
4.3.2	Emphasis on time-varying delay systems	82
4.3.3	Stabilization and control of time-delay systems	84
4.3.4	Finite dimensional controllers and observers for time-delay systems	84
4.4	Stability and control of infinite dimensional systems	86
4.4.1	Stability of coupled linear ODE-PDE systems	87
4.4.2	Stabilisation of PDE systems and backstepping methods	89
4.4.3	Sampled-data and event-based control of PDE	90

Preface

This manuscript aims at presenting a synthetic view of the research and accomplishments I have been pursuing since I started my PhD. Of course, this document is full of equations, theorems, proofs and, unfortunately, full of LMIs and functionals (I did my best to not provide too many of them). This document however does not illustrate and reflect the personal view on this fantastic profession. The contributions presented in this manuscript are the fruit of numerous interactions with students and colleagues in France and abroad. Hence, I would like to take few lines of this manuscript to express my feelings towards them before entering into the core of the science.

The first words of this preface are naturally addressed to the three reviewers of my manuscript. I was deeply honored to have Prof. Dr. Sandra Hirche, Prof, Dr. Carsten Scherer and Prof. Jean-Michel Coron as reviewers of my work. I would like to express my gratitude for having carefully read my manuscript and expressing warm recommendations on it. Their comments and encouragements mean a lot to me. I also take the opportunity of this preface to like to thank the other members of the jury, Sophie Tarbouriech, Jean-Pierre Raymond, Jean-Pierre Richard, Jamal Daafouz, Silviu-Iulian Niculescu, and Christophe Prieur, for accepting my invitation. I know how their time is precious and I was delighted to see their enthusiasm to participate to the jury.

I discovered the academic and research world in 2003 when I started my PhD in Ecole Centrale de Lille. This experience has really been a revelation for me. I am deeply grateful to Jean-Pierre Richard and Michel Dambrine for providing me with all the opportunities to start this career. This “Lilloise” or “Ch’tite” experience with them and all the members of the SyNER team was full of professional and personal accomplishments. This experience was then pursued with two post-docs in Leicester, in UK, and at KTH, Stockholm in Sweden. At the origin, these two years abroad were only meant to improve my ashamed and inglorious English level. More than that, I finally discovered the life and work with new colleagues, new friends or both, in other labs, in other countries. I have deeply modified my view and opinion on many things thanks to this experience. I thus would like to express my deepest gratitude to Sarah K. Spurgeon, Christopher Edwards, Karl-Henrik Johansson for giving me this chance. A bottom line is also to mention Dimos V. Dimarogonas for the mutual support during this Swedish winter.

My French career at CNRS started in 2008 when I was hired at GIPSA-Lab in Grenoble. I only spend three or four years in the NeCS Team, joint CNRS and Inria - Rhône-Alpes project team led by Carlos Canudas de Wit. This too short but intense experience in Grenoble was much richer from the professional and personal point of view than I could imagine. I would like to express my gratitude to Carlos Canudas de Wit, Daniel Simon, Alain Kibangou and Federica Garin for the interactions we had in the NeCS team and Olivier Sename, Emmanuel Witrant, Christophe Prieur, Nicolas Marchand and all the Department of Automatic Control of GIPSA-Lab for the nice time we spent inside but also outside the lab.

When I arrived at LAAS - CNRS in Toulouse, I have experienced another intense professional and personal life. I met new colleagues/friends from who I have shared and learned a lot. When I arrived, my first intention was to collaborate with my older PhD “brother”, Frédéric Gouaisbaut. The numerous and efficient discussions on time-delay systems have led to the main contributions presented in this manuscript. I would like to have a special attention to Sophie Tarbouriech, my “Parrain” and Isabelle Queinnec, who joked, pushed, and encouraged me so many times for writing this habilitation. The last words go to Luca Zaccarian, my Italian office mate, Lucie Baudouin and Dimitri Peaucelle, and all the members of the MAC team. Their enthusiasm has often a great impact on the working atmosphere at LAAS.

I would like to thank several colleagues and friends, with who I have been collaborating for a long time: Corentin Briat, Charles Poussot-Vassal, Laurentiu Hetel, Emilia Fridman, Kun Liu, Prathyush Menon, João Gomes Da Silva Jr, Sabine Mondié, Giorgio Valmorbida. The main purpose of the “Habilitation à Diriger des Recherches” being the opportunity to supervise PhD students, I would like to have warm thought to my former and current PhD students and Post-doc, Lara Briñon Arranz, Gabriel Rodrigues de Campos, Patrick Andrianiaina, Alica Arce Rubio, Fabien Niel, Mohammed Safi and Matthieu Barreau. I hope that they have appreciated the time we spent together. I wish them all the best for their future.

I will end this preface to dedicate few words to my family. My arrival to Toulouse coincides with the wedding with my wife Carolina Albea Sanchez, and more lately to the birth of two wonderful boys Adrian and Marco. This manuscript is obviously dedicated to them and to their everyday love. Muchas gracias, Carolina, por toda esta aventura que hemos vivido con dos, tres y ahora cuatro. No ha sido fácil todos los días motivarme para escribir este HDR. Gracias por eso y especialmente por todo lo demás.

Notations

Definition of sets:

- \mathbb{N} : Set of positive integers
- \mathbb{Z} : Set of natural integers
- \mathbb{R} : Set of real numbers
- \mathbb{C} : Set of complex numbers
- \mathbb{R}_+ : Set of non negative real numbers
- \mathbb{R}^n : Set of n dimensional real valued vectors
- $\mathbb{R}^{n \times m}$: Set of matrices of n rows and m columns
- \mathbb{S}^n : Set of symmetric matrices of dimension n
- \mathbb{S}_+^n : Set of symmetric positive definite matrices of dimension n

For any vector x in \mathbb{R}^n and matrix A in $\mathbb{R}^{n \times m}$:

- x^T : Transpose of vector x
- A^T : Transpose of matrix A
- $\|x\|$: Euclidenne norm of a vector x
- $\|A\|$: Euclidenne norm of. matrix A
- a_{ij} : Coefficient of matrix A in the i^{th} row and j^{th} column
- I_n : Identity matrix of $\mathbb{R}^{n \times n}$ (The subscript “ n ” will be ommitted which permitted)

- $A \prec 0$ (resp. $A \succ 0$) : A is symmetric negative (positive) definite of $\mathbb{S}_+^n \subset \mathbb{R}^{n \times n}$
- $\lambda_{\min}(A)$ (resp. $\lambda_{\max}(A)$): is the minimum (resp. maximum) eigenvalue of a symmetric matrix of \mathbb{S}^n

For any h in \mathbb{R}_+ :

- $\mathcal{C}([-h, 0]; \mathbb{R}^n)$: Set of continuous functions from $[-h, 0]$ to \mathbb{R}^n
- $\mathcal{C}^1([-h, 0]; \mathbb{R}^n)$: Set of continuously differential functions from $[-h, 0]$ to \mathbb{R}^n
- $\|\cdot\|_h$: Supremum norm on \mathcal{C} defined by $\forall \phi \in \mathcal{C}([-h, 0]; \mathbb{R}^n) : \|\phi\|_h = \sup_{\theta \in [-h, 0]} \{\|\phi(\theta)\|\}$

Chapter 1

General Introduction

Contents

1.1	Networked Control Systems with limited information	2
1.1.1	Communication delays	3
1.1.2	Time-quantization	4
1.1.3	Space-quantization	4
1.1.4	Distribution and neighboring	5
1.2	Summary of the contributions	5
1.2.1	Time delay systems	5
1.2.2	Robust sampled-data control	6
1.2.3	Event-based control & hybrid dynamical systems	7
1.2.4	Multi-agent and distributed systems	8
1.2.5	Infinite-dimensional systems	10
1.3	Organization of the manuscript	11

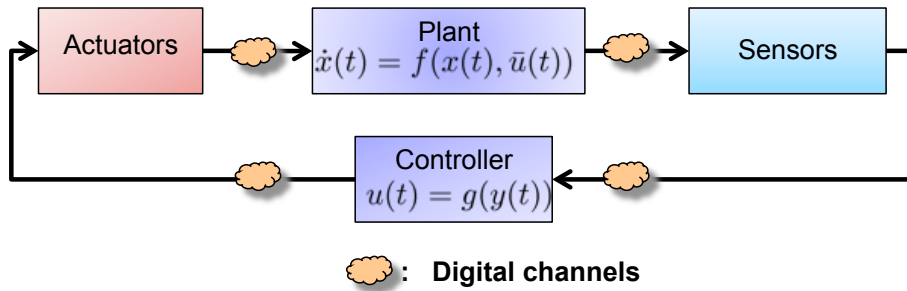

Figure 1.1: Modified control loop in view of networked control systems.



Figure 1.2: Effect of a network communication link

1.1 Networked Control Systems with limited information

Networked Control Systems (NCS) represent today a general paradigm for describing phenomena in various domains such as Biology (for genes transcription networks or models of schools of fishes), Robotics (in tele-operated manipulators for medical applications or in coordinated unmanned vehicles), Computer Sciences (congestion control and load balancing in the Internet management), Energy Management (in electric grids), Traffic Control (fluid models of traffic flow) etc. The analysis and design of networked systems represent nowadays an important challenge in the Automatic Control community.

An enormous scientific and industrial interest has been given to NCS, which are ubiquitous in most of modern control devices. An NCS is a control system wherein its components (plants, sensors, embedded control algorithms and actuators) are spatially distributed. The defining feature of an NCS is that control and feedback signals are exchanged among the system's components in the form of digital information packages as depicted in the simple control loop presented in Figure 1.1. The primary advantages of an NCS are reduced wiring, ease of diagnosis and maintenance and increased flexibility. Despite of these advantages, the use of communication networks also introduces several imperfections that will be described latter. Such imperfections may lead to poor system performances and even instability if not appropriately taken into account. The practical and theoretical challenges brought in the context of NCS rely on the consideration of the imperfections induced by the use of communication networks in control loops.

Initial and classical problems in Automatic Control refers to the design of stability conditions, stabilizing controller and observers for dynamical systems (see [19, 171] to cite only few). As it was mentioned earlier, the main challenges in the vision brought by NCS are related to the fact that systems may be composed of different distributed elements, which are connected through a communication network. Because of bandwidth and debit limitations, the communication brings unavailable distortion to the information to be transmitted. Therefore, an initial information $x(t)$ becomes after passing through a communication network, a notably modified signal $\hat{x}(t)$ as depicted schematically in Figure 1.2. To get an overview of the related problem the reader may refer to the

survey papers [137, 153, 352, 347].

Network links with limited capacity and bandwidth can be modeled in various manners. A first model consists in including into the control loop a *quantization* process, which basically constrains a signal evolving in a continuous set of values to a relatively small and possibly *saturated* discrete set. Another model has been proposed to describe the discretization in time of the exchanged information. Embedded control algorithms use *sampled versions* of the system state or output. The difficulty lies in fact that, in real time applications, sampling is often generated in an asynchronous manner. This issue makes the analysis and design of NCS a complex task. On one side, this asynchronism may represent an undesired phenomena (jitter or packet drop-out) and it may be a source of instability. From the control theory point of view, it must be taken into account in a robust manner. On the other side, one may deliberately introduces asynchronism in the control loop via scheduling algorithms, in order to reduce the number of data transmissions and, therefore, optimize the computational costs. This corresponds to the recent research trend of *event-based control*, where a data is transmitted only if a particular event has occurred. The new challenges for control design of NCS are particularly evident in large-scale interconnection of multi-agent systems. For example, in formation and cooperation control, it is not reasonable, from the practical point of view, to allow all-to-all communication. Each agent has only a *local view* of the overall network and he may not be able to store and manipulate the complete state of the system. Hence, an agent is able to exchange information only with its neighbors, in the space or in the communication graph.

The reminder of this section exposes the main difficulties and challenges regarding the control with limited information.

1.1.1 Communication delays : $\hat{x}(t) = x(t - h)$, $h > 0$

This first aspect of limited information is not properly linked with the limitation of the information data itself but rather on the limitation of the debit of the communication link. Indeed, the transmission of information through a communication network is not performed in an instantaneous manner. There always exists a communication delay to get the information at the receiver side. Depending on the network properties (for instance wire or wireless), this delay can be small and negligible or large, almost constant or with notable variations. The size of the delay has to be regarded with respect to the dynamics of the system affected by this delay. Indeed, if a controlled system is stabilizable without delay, it will still be stable even if the controller is affected by a sufficiently small delay. The main issue is to quantify the “sufficiently small” delay so that the closed-loop system remains stable. Generally speaking, delays are often the source of a decrease of performance and lead to unstable behavior.

From the control point of view, the effects of delays have been well studied in the literature. The reader may refer to [101, 135, 222, 261], where a history of this field is provided. This class of systems may be studied using a frequency domain approach [136, 318], a time-domain approach [101], Integral Quadratic Constraints (IQC) [337, 169, 170], Quadratic separation [14, 127, 128]. Note that the three last method usually leads to stability conditions expressed in terms of Linear Matrix Inequalities (LMI) [11, 83, 269] that can be easily implemented on Matlab using semi-definite programming algorithms [180, 193].

1.1.2 Time-quantization : $\hat{x}(t) = x(t_k), t \in [t_k, t_{k+1}]$

Another limitation due to the presence of a communication network is the time-quantization of the information. Indeed due to bandwidth limitations, the current information $x(t)$ cannot be transmitted continuously and only samples of the information $x(t_k)$, where $\{t_k\}_{k \in \mathbb{N}}$ represents a strictly increasing sequence of sampling instants such that $\lim_{k \rightarrow \infty} t_k = \infty$. This limitation does not only appears in NCS but more generally when the control loop is composed of digital components and consequently working in discrete time. Even if new technologies make reasonable the idea of components working in high frequency, i.e. with small sampling interval (or $t_{k+1} - t_k \ll 1$), it might be also reasonable to think that one may reduce the energy consumption in the network or in the digital controller by reducing the frequency and, consequently, enlarging the latency between two successive sampling instants. As for the delay situation, if one is able to design a continuous-time controller that stabilizes the closed-loop system, there exists a sufficiently small bound on the sampling interval ($t_{k+1} - t_k$) such that the sampled-data closed-loop system remains stable. Again, the notion of “sufficiently small” sampling interval has to be quantified in order to improve the co-design of the controller, i.e. the control law as well as the frequency. Several articles drive the problem of time-varying periods based on a discrete-time approach [154, 226, 350]. An input delay approach using the Lyapunov-Krasovskii (LK) theorem is provided in [105]. Improvements are provided in [113, 209], using the small gain theorem and in [218] based on the analysis of impulsive systems.

On a second hand, an increasing attention has been paid to the so-called event- or self-triggered control paradigm [7, 8, 17, 18, 147]. In this framework, the samplings instants are seen as an additional degree of freedom to the controller. In other words, the controller delivers both the value of the control input and the time instant at which this value must be implemented. From the theoretical point of view, one may consider input-to-state stability-type of conditions [327, 197], Lyapunov-based approaches [338, 310] or hybrid dynamical systems approach [2, 146].

1.1.3 Space-quantization : $\hat{x}(t) = q(x(t)), q(x(t)) \in \{q_1, q_2, \dots, q_N\}$

Following the same principles of the time-quantization described in the previous paragraph, the discretization of the information to be transmitted through the network imposes another deterioration with respect to the initial message. The bandwidth constraints limit the size of the message. Therefore, the information is reduced to a limited number of bits, leading to a quantified version of the initial data. For instance, it can be illustrated as the reduction of the real number π to 3.14. The remaining question can be resumed as the impact of this reduction to the closed-loop systems. Space-quantization is often related to another relevant constraints which is the saturations of the information. This is indeed due to the limitations on the number of digits in a data packets. The problem of controlling a system subject to quantization and saturations has been the subject of many researches over the past years. The reader may refer to [53, 71, 92, 112, 157, 183, 217] for the sole quantization aspects and to [56, 122, 329, 332, 333] for saturations ones. One of the main difficulties related to these two classes of nonlinear problems is due to the fact that global or local, asymptotic or practical stability issues needs to be discussed with precautions.

1.1.4 Distribution and neighboring : $\hat{x}(t) = \begin{bmatrix} \delta_1 & & \\ & \ddots & \\ & & \delta_n \end{bmatrix} x(t)$, $\delta_i = 0, 1$

Another source of disturbances due to the limitations of the communication link is related to the quantity of information to be transmitted over the network. One may think that some components contained in the global information vector $x(t)$ are not available and only a partial and limitations version of $x(t)$ has been selected to be forwarded to the network.

This situation does not only refer to the situation of constructing output feedback control laws for a usual control problem. Indeed, this limitations is also connected to the study of multi-agents systems from the point of view of Automatic Control. This area have received much attention in recent years. The field includes consensus algorithms for multi-agent systems [231, 229, 258], flocking [228], distributed sensor networks [225, 358], and autonomous systems as underwater and unmanned air vehicles (AUVs and UAVs) [182, 256]. Cooperative formation control and motion coordination have been extensively studied, see [89, 268, 200, 224], among many others. Another aspect deals with the distributed control and estimation problem for distributed systems [156, 206, 207].

1.2 Summary of the contributions

My contributions related to Networked Control Systems since I started my PhD can be organized as follows. I have been interested in the stability analysis, stabilization and observation problems with a particular attention to the five following topics

- Time-delay systems
- Robust sampled-data control;
- Event-based & hybrid dynamical systems
- Multi-agents systems & distributed control
- Infinite dimensional systems.

Indeed, these five items cover a broad range of systems encountered in the fields of NCS. The next sections aim at presenting a brief but detailed summary of the main contributions with a particular attention on their improvements with respect to the literature. In addition, a table is presented to summarize the main publications, the projects, the PhD students and post-doc, and main collaborators related to each topic.

1.2.1 Time delay systems

As mentioned earlier in this introduction, the presence of delays in a control loop may have a visible effect on the stability of a closed-loop system. In order to evaluate the robustness of a system with respect to the delay, a popular direction refers to the application of the Lyapunov-Krasovskii theorem. This method leads to conditions usually expressed in the frameworks of Linear Matrix Inequalities (LMI), which can be easily solved with semi-definite programming algorithms. The main objective

is there to reduce the conservatism of the resulting conditions. In other words, the conditions are evaluated with respect to the accuracy of the numerical results and the complexity of the LMI, which depends on the number of decision variables and the size of the LMI. I have contributed since the beginning of my PhD in 2003 to the problem of exponential stability and stabilization of time-delay systems [284], with input saturations [123, 124], the design of sliding mode controllers and observers [290, 289, 288], where the main motivation was to understand how saturations, sliding mode controllers can be included in the presence of delays.

In the literature, most of the contributions are based on the a priori selection of Lyapunov functionals and the application of Jensen's inequality, which basically represents an efficient integral inequality related to the Cauchy-Schwartz inequality. This lemma has been seen for a long time as the unique technical tool allows one to get LMI conditions and I have followed this line at the beginning of my career. Nevertheless, it is also well-known that this inequality brings some inherent conservatism which can be reduced using a discretization process [40]. Looking at the recent literature, we have proposed a new approach, which consists in providing an alternative vision of this inequality first as a consequence of the Wirtinger inequality [296] and second as a Bessel-like inequality [298] on Hilbert spaces, the second one being a generalization of Jensen's and the Wirtinger-based integral inequalities. It appears that these two new contributions have received some attention in the time-delay community for several reasons. The associated approach provides efficient numerical results compared with the literature, from the point of view of the reduction of the conservatism and the computational complexity. It has opened new and productive directions of research on efficient integral inequalities for time-delay systems. This aspect will be fully described in Chapter 2.

1.2.2 Robust sampled-data control

An important aspect of NCS arises from the discretization and asynchronism of control data when transmitted through a communication network. The problem of robust sampled-data control has attracted a large number of researchers over the last decade. Together with several colleagues, we have prepared the survey paper [155], which describes most of the methods that allow the analysis of this class of systems such as the discrete model approach [66, 79, 148, 149, 154, 227], variable delay [105, 205], robust approaches [113, 168, 233] and hybrid systems [220, 219].

Among the methods presented in this survey paper, I particularly want to highlight two contributions. The first one, [105, 195], which was initiated at the beginning of my PhD, introduced the input-delay approach with a complete analysis issued from the application of the Lyapunov-Krasovskii theorem. At that time, the contributions on the stability analysis of linear systems subject to time-varying delays was stuck because of a constraint on the time-derivative of the delay function h , i.e. $\dot{h}(t) < 1$, which actually corresponds to the critical constraints in the input delay approach for sampled-data systems. Together with E. Fridman and J.-P. Richard, we have used the recent contribution of [107], which was able to remove this constraint from the stability conditions, giving thus rise to the extension to sampled-data systems as it will be explained in Chapter 3.

The second approach was presented in [280], and then named looped-functionals in [48]. Together with C Briat, when he was post-doc at KTH, Sweden, we developed a new theoretical class of functionals, that is particularly relevant to the case of sampled-data systems but also impulsive and switched systems in the particular situation when the sampling, impulse or switching instants only depend on time. The particularity of this class of Lyapunov functionals compared to Lyapunov-Krasovskii ones relies on the possibility to relax some positive definite constraint in the design of the functionals. These two approaches will be developed in Chapter 3.

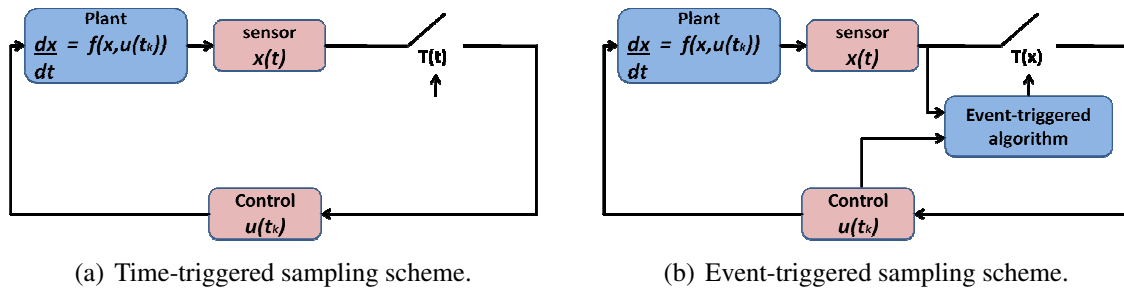

Figure 1.3: Sampled-data implementation in [310, 311].

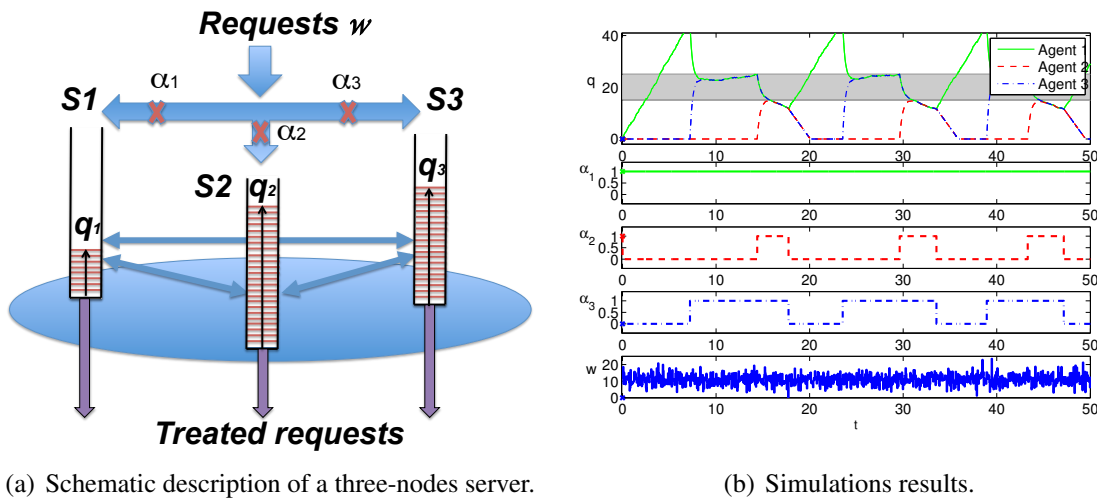

Figure 1.4: Hybrid control of a three nodes server in [4, 5].

1.2.3 Event-based control & hybrid dynamical systems

Event-based control represents a very active field of Automatic Control since approximately a decade. The problem is quite different from the one of the robustness analysis of the sampled-data systems presented in Section 1.2.2, where the sampling instants are defined by an external operator as depicted in Figure 1.3(a). The sampling is no longer seen as a perturbation but as an additional control input. In other words, the next sampled-data control update is triggered when some function of the systems state crosses a predesigned threshold and generates an event as showed in Figure 1.3(b). To better understand this paradigm, the principle can be interpreted as follows: “As long as the state of the system behaves correctly, it is not necessary to change the control value”. As a result, this controller type brings new performance in terms of energy gain and computing time. The reader may refer to one of the first contributions in this direction to [17] and to the more recent works [8, 147, 197, 252, 327, 328] to cite only few papers. More details about this field are provided in Chapter 4.

I have started to investigate on this direction in 2010 in [310, 311] in collaboration with C. Prieur and N. Marchand (CNRS, GIPSA-Lab). I have continued this activity with S. Tarbouriech and L. Zaccarian (LAAS) with particular attention to hybrid dynamic modeling, which proves to be a particularly effective angle of attack to represent this class of controller systems. Compared to the existing literature, we decided to focus mainly on event-based control problems with saturation constraints [313, 315, 314] or with output-feedback control [314, 330].

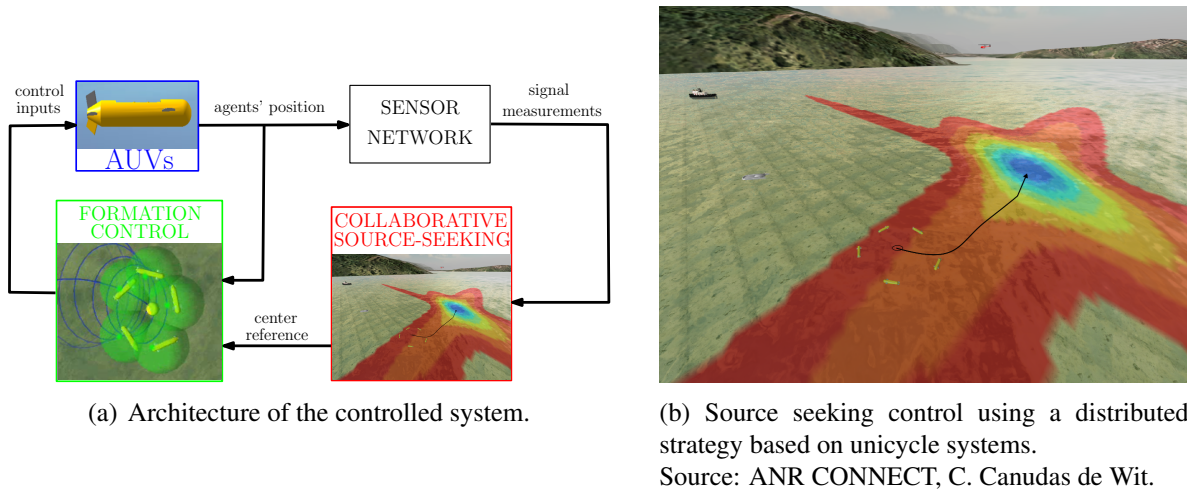

Figure 1.5: Formation control and source-seeking strategies for nonlinear multi-agent systems developed during the PhD of Lara Briñon Arranz in [52] and supported by the FP7 EU STREP Feed-NetBack and ANR CONNECT Projects.

A notable side effect of this work is that it made me discover the Hybrid Dynamical Systems framework (see [118, 119]) and its potential to model systems composed by continuous and discrete dynamics. I was confronted to other problems that can be effectively represented in this framework and which are not only related to the sampled-data systems. For example, we have developed hybrid control laws for controlling a network of servers (see [4, 5]), summarized in Figure 1.4. The main contribution there was to develop a hybrid control strategy that allows to trigger the activity of a node ($\alpha_i = 1$ if the node is on and 0 if not) such that a consensus on the queue length q_i of the servers, which are modeled by a single integrator, is achieved among the active nodes.

1.2.4 Multi-agent and distributed systems

A multi-agent system is a system composed of autonomous agents, evolving in a certain environment. They interact in a collaborative and distributed manner to accomplish a common task. In general, an agent represents a process, a robot, human being, etc... From the Automatic Control point of view, several interests appear for some applications such as the cooperation of (mobile) robots, such as drones, robots or autonomous submarines, or in a network of sensors in intelligent buildings, synchronization of clock, etc... There exists a large number of theoretical tools that allow the synthesis of decentralized or distributed orders, such as, for example, algorithms of consensus [89, 229, 258]. The main goal of consensus algorithms is to allow agents to find an agreement on a given quantity of interest. Once again, communication among agents adds new dynamics that can degrade the performance of the overall system. Furthermore, it appears that the connectivity of the communication network, which refers to the graph theory [264], has a significant impact on the performance of the algorithm. In this context, the main lines of research on which I have concentrated are the following.

Distributed formation and source seeking control

A first study I have conducted during the PhD of L. Briñon Arranz concerns the design of control strategies that allow a fleet of agents following unicycle dynamics to move in a circular formation.

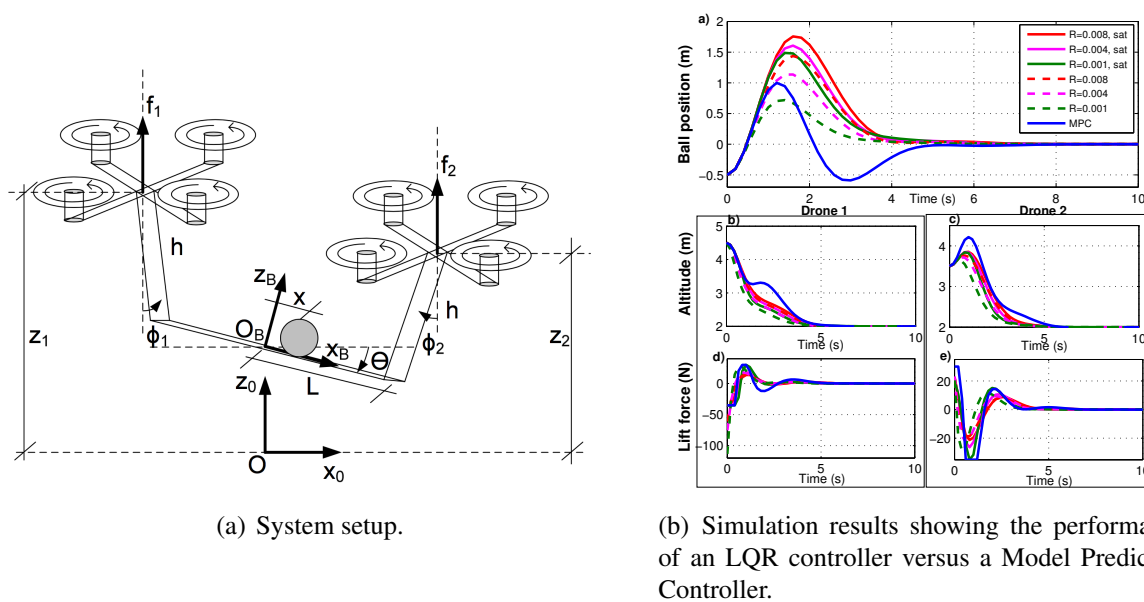

Figure 1.6: Distributed strategy for load carrying Drones developed in the context of A. Arce Rubio's post-doc and Fabien Niel's PhD, supported by the MDrones project.

This problem is pertinent to some applications where the agents should perform collaborative tasks requiring the formation to displace towards an a priori unknown direction [67]. For instance, in source seeking applications, the formation is displaced in the source gradient direction (which is computed on-line, and instrumented as an additional outer loop) [182].

Formation control has been extensively studied in [182, 275, 199, 224, 274, 273, 187] among many others. These studies concern circular and parallel formations [275, 274, 273], but also motions of formation induced by flocking [230, 259]. One strategy to produce formation motions (i.e. flight formations) is the virtual-leader approach [256], where an agent is designed as being the leader, and then a suitable inter-distance (and orientation) is set between agents. The motion of the formation results from the motions of the leader. Although it is possible to create circular formations via a particular pursuit graph as suggested in the work of [199], it turns out impossible to apply these methods to the problem of circular formation if the formation is desired to be keep "rigid" while moving. In the context of the source seeking problem of underwater vehicles advocated here, it is necessary to keep AUVs (uniformly distributed) formation during the source search to avoid unnecessary energy waist, and to produce efficient search motions.

In order to design control laws that allow source seeking, we have provided several layer of controllers whose structure is presented in Figure 1.5(a) and whose objectives includes translation and contraction control while achieving a uniformly distributed circular formation in the conference papers [34, 36, 35, 39] or the summarized journal version [52]. One of the interests of this uniformly distributed control law is the development of distributed gradient estimation that was developed in [37, 38]. Then, we have considered the whole problem of source-seeking control in [33], leading to trajectories presented in Figure 1.5(b).

Another aspect developed during the PhD of G. Rodrigues de Campos and summarized in [262] is the inspection and deployment of mobile robots. The principle is to determine a control law ensuring a compact deployment of a fleet of mobile robots to cover the largest surveillance area.

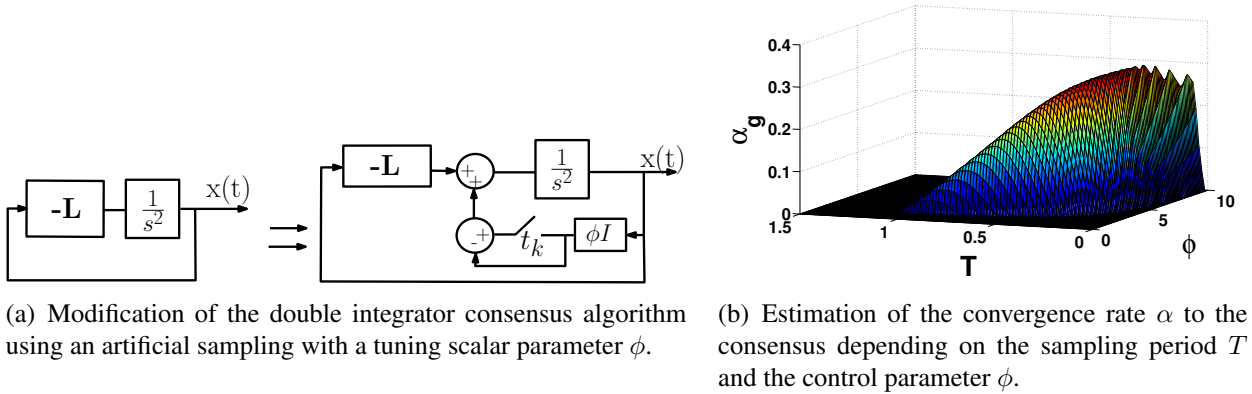

Figure 1.7: Improved double integrator consensus algorithm using artificial samplings.

Distributed control for load-carrying drones

This project related to F. Niel’s PhD and A. Arce Rubio’s Post-doc consisted in the design of distributed control laws assuring a safe transportation of a load performed by several drones. This situation is relevant in practice since it provides an unmanned alternative to the transport of materials or water in dangerous areas. The main motivations of this work were to consider the interaction of agents that are not simply connected through a network link but also through a mechanical relationship. To illustrate this problem, we have revisited the “Ball and Beam” problem in the situation when the actuation of the beam is performed by two different drones as depicted in Figure 1.6. We have studied a linearized version of this problem [12]. More especially, the expertise of A. Arce Rubio on Model Predictive Control have conducted to the comparison of several centralized/distributed control laws, with a particular attention to the computational issues of this class of controllers.

Robustness and design of consensus algorithms

A first study concerns the robustness study of consensus algorithms with respect to delay and sampling phenomena following the idea of [214, 215, 230]. I have started this study during my post-doc at KTH with D.V. Dimarogonas and K.H. Johansson [287, 286]. Then, in the context of G. Rodriguez de Campos, we have studied and evaluated the robustness of consensus algorithms with respect to periodic and asynchronous samplings [263, 263]. The interesting by product of this study is briefly presented in Figure 1.7, where the idea is to include an artificial sampling in consensus algorithms. While one may think of a decrease of the performance, we have shown that, for the single or double integrator, the performance can be notably increased as showed in Figure 1.7(b). Indeed, the best convergence rate α of the algorithm is not obtained when the sampling period T or the parameter ϕ are zero (i.e. continuous time case). More recently, in [241, 242], the main idea is to find the best weights to allocate to the different communication links between agents to improve the performance of the algorithm.

1.2.5 Infinite-dimensional systems

This last aspect corresponds to a topic that I have recently studied since 2015. Infinite dimensional systems are systems whose dynamics are governed by partial differential equations (see, for example, [25, 72, 179, 178]). They are found in a large number of applications related to traffic control [158],

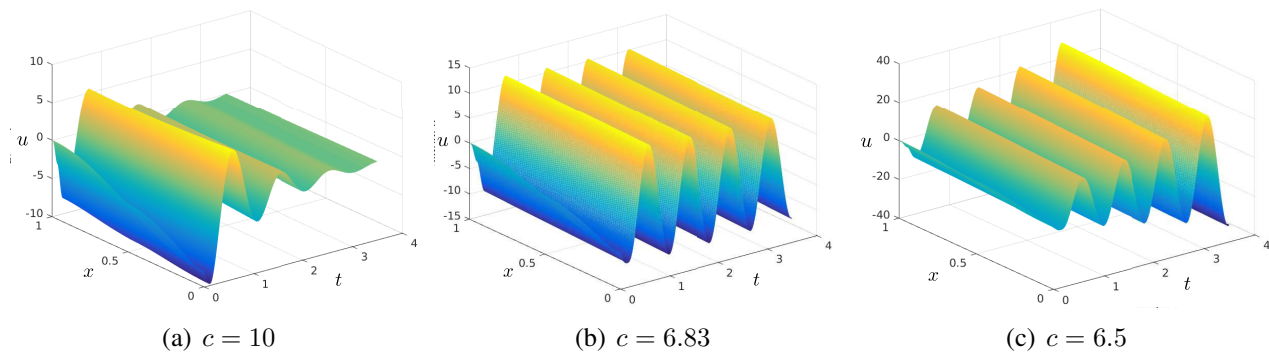

Figure 1.8: Chart of u for system composed of the coupling of an ODE and the wave PDE, characterized by the wave speed c with the parameters: $u^0(x) = (\cos(\pi x) + 1) \frac{KX_0}{2}$, $X(0) = [1 \ 1]^T$, $v^0(x) = 0$ and $c_0 = 0.15$ for 3 values of c , presented in [24].

tokamak [340], etc... This new direction can be seen as a natural extension since delay systems can be already seen as special cases of such a class of infinite dimensional systems. The goal of my activities is to know whether the methods of analysis, control and observation developed in the framework of delay systems (that will be detailed in Chapter 2) can be extended to a larger class of systems of infinite dimension and more particularly sys (PDE) with a finite-dimensional system (ODE). As a complementary approach to the predictor and backstepping controllers from [178], we want to find a new method for the stability analysis of a larger class of infinite dimensional systems than the sole time-delay ones. The novelty of this approach comes from the use of the Bessel inequality that we have put forward in the framework of the delay system analysis [298], but which proves to be equally relevant in the framework of other classes of infinite dimensional systems. This research topic corresponds to the objectives of the project ANR JC/JC SCIDIS. We have already obtained our first promising results for the analysis of coupled linear systems between a transport PDE and an ODE [28, 266, 267], but also with the heat equation [27] and the wave equation [24]. To get a better understanding of the objective, Figure 1.8 has been included to illustrate the results obtained in the context of M. Barreau's PhD, and more particularly on the design of speed-dependent stability conditions for a systems composed of an ODE, $X(t)$, and the wave PDE, $u_{tt}(x, t) = c^2 u_{xx}(x, t)$, characterized by the wave speed c and with boundary conditions $u(0, t) = KX(t)$ and $u_x(1, t) = -c_0 u_t(1, t)$. The stability conditions, resulting from the use of the Bessel-Legendre inequality, are able to characterize stability regions of the speed of the wave equation, c . Figure 1.8 presents three simulations of this system with three different speeds. More particularly, Figure 1.8(b) shows the situation where the lowest speed parameter $c = 0.683$, for which the closed-loop system remains stable, where the solutions converges slowly to the equilibrium. These activities will be discussed in Chapter 4.

1.3 Organization of the manuscript

In order to propose a synthetic view of my research, I made the choice of presenting a focus on only two of the five aspects presented earlier in this chapter. The remainder of the manuscript is organized as follows:

- **Chapter 2: Time-delay Systems.** The next chapter aims at exposing the main challenges related to the stability analysis of time-delay systems. After a brief presentation of the main difficulties when dealing with this particular class of infinite dimensional systems with respect to the non-delay case, a description of the main methods and procedures to derive stability conditions based on the application of the Lyapunov-Krasovskii theorem, which has attracted many researchers for more than two decades. A particular emphasis is proposed on the key technical tool to derive stability conditions for delay systems, the so-called Jensen's inequality, which was presented in the context of time-delay systems in [133]. After a discussion on some recent contributions, which refine this first integral inequality including the Wirtinger-based integral and the Bessel-Legendre inequalities is given, an application of the Bessel-Legendre inequality is presented to cope with the stability analysis of linear systems subject to a single and constant delay. Finally, the chapter ends with the illustration of the previous methodology on several numerical examples and problems.
- **Chapter 3: Sampled-data Systems.** This second contributed chapter deals with the stability analysis of systems subject to asynchronous samplings. After a brief motivation of the problem and a brief review of the literature on this topic, the chapter presents two possible methods to assess stability of this class of systems. The first one is the so-called "input-delay approach" [105] and consists in noting that the sampling effect can be modeled as a particular class of time-delay systems subject to a saw-tooth delay functions. This modeling allows one to use the methods and techniques from the time-delay systems theory as presented in the previous chapter. Compared to Chapter 2, an emphasis is done on the time-varying delay case. The second approach to be presented in this chapter refers to the class of Lyapunov functionals introduced in [280], called looped-functionals. The main features and differences with respect to the input-delay approach are described as well as their potential extensions. The chapter ends with an application of this second method to the local stability analysis of linear continuous-time systems controlled by a saturated discrete-time dynamic output controller. This example demonstrates that the looped-functionals method can be combined with other tools issue from the saturation theory.
- **Chapter 4: Conclusions and Perspectives.** After a brief conclusion, this chapter aims at drawing several perspectives for my future researches. These perspectives can be summarized under the title of "stability and control of heterogenous Cyber-Physical Systems". First, a discussion presenting the perspectives linked to what is presented in Chapters 2 and 3 on time-delay, sampled-data systems and event-based control. These axes represent the short term researches I envisioned for the next following years. In a second time, I will discuss about a new direction of research (for me) related to the stability and control of infinite-dimensional systems and more particularly on systems composed by the interconnection of ordinary differential equations and of partial differential equations.

Chapter 2

Time-delay systems

Contents

2.1	Introduction	14
2.1.1	Particularities of time-delay systems	14
2.1.2	System and delay models	16
2.1.3	Usual assumptions on the delay functions	18
2.2	Stability of time-delay systems using the 2nd Lyapunov Method	20
2.2.1	Second Lyapunov method	20
2.2.2	Lyapunov-Razumikhin approach	20
2.2.3	Lyapunov-Krasovskii approach	22
2.3	Integral inequalities and time-delay systems	25
2.3.1	Jensen's inequality	26
2.3.2	Wirtinger-based integral inequality	26
2.3.3	Extension of the Wirtinger-based inequalities	30
2.3.4	Bessel-Legendre inequality on Hilbert spaces	30
2.4	Application to linear systems with a constant delay	38
2.4.1	Stability theorem	38
2.4.2	Remark on the choice of the Lyapunov-Krasovskii functional	40
2.4.3	Hierarchy of LMI stability conditions	41
2.5	Numerical applications and extensions	43
2.5.1	Linear systems with a single discrete delay	43
2.5.2	Linear systems with multiple discrete delays	46
2.5.3	Linear systems with a distributed delay	47
2.6	Conclusions	48

2.1 Introduction

2.1.1 Particularities of time-delay systems

Unlike more classical systems governed by ordinary differential equations, time-delay systems represent a particular class of infinite dimensional systems that can be modeled for instance by the coupling of an ordinary differential equation and a partial differential equation. This particularity has several implications on the properties of the time-delay system under consideration.

This section introduces some of the basic particularities of time-delay systems in terms of mathematical considerations through a simple example. More particularly, this section exposes some reasons for which researches are still investigating in the topic. To have a better understanding and reading of this section, we will focus on a simple example. The goal is to help the reader to understand the most relevant aspects of time-delay systems. Let $x \in \mathbb{R}$ be a variable whose evolution is governed by:

$$\forall t > t_0, \quad \dot{x}(t) = -x(t - h) \quad (2.1)$$

where $h > 0$ is a positive scalar which represents a constant delay. If one considers the delay-free case, i.e. $h = 0$, it is well known that the solutions of the system are stable and are of the form $x(t) = x(t_0)e^{t_0-t}$. In the following, particular aspects of this equation with delay will allow us pointing out the major difficulties of time-delay systems and the difference with the delay-free case.

Initial conditions and functional state: Consider the case where $h = -\pi/2$. The two functions $x_1(t) = \sin(t)$ and $x_2(t) = \cos(t)$ are trivial solutions of (2.1), which are depicted in Figure 2.1. In this figure, one can find a contradiction with the Cauchy theorem. In the delay free case, if two solutions of this linear differential equation cross, then the two solutions are the same. In this simple example, it is clear that the two solutions x_1 and x_2 cross each other infinitely many times but are, by definition, not equal. This problem comes from the fact that the state of a time-delay system is not only a vector considered at an instant t , as it is in the delay free case, but is function taken over an interval (or a window) of the form $[t - h, t]$. Consequently, it is not sufficient to initialize the state of the system by only including the initial position of the state at time $t = 0$. It is required to define a vector function $\phi : [-h, 0] \rightarrow R$ such that $x(\theta) = \phi(\theta)$ for all θ lying in the first delay interval $[-h, 0]$.

Note, however, that the Cauchy theorem still holds. It is rewritten as follows: If two solutions are equals over an interval of length h , then the solutions are equals over the whole simulation time.

Infinite dimensional systems: Consider $h = 1$ and the initial conditions $\phi(\theta) = 1$, for all θ in $[t_0 - h, t_0]$. The solutions are shown in Figure 2.2.

As expected, in the non delay case, the solution is a exponential decreasing function. In the delay case, the solution are not always of this form anymore. First the solution have an oscillatory behavior around 0. Those oscillations are the usual and expected effects when introducing a delay in a dynamical system. For small values of the delay, those oscillations can of very low amplitude and thus negligible. However, for greater values of h (for instance $h = 2$), the oscillations become of large amplitude and the solution are unstable.

Considering $h = 1$ and the same initial conditions, it is possible to construct the solution of the

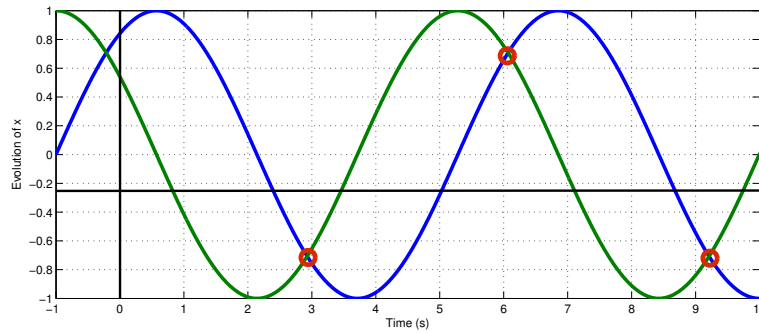

Figure 2.1: Possible solution for $h = \pi/2$

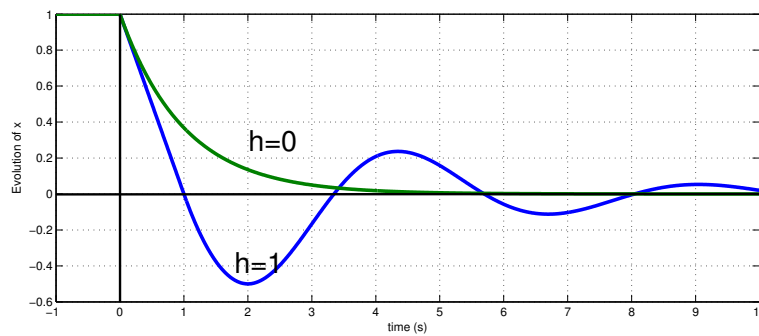

Figure 2.2: Solution for $h = 0, 1$ and constant initial conditions

system by integrating interval by interval:

$$\begin{aligned} t \in [-1, 0], & \quad x(t) = 1, \\ t \in [0, 1], & \quad x(t) = 1 - t, \\ t \in [1, 2], & \quad x(t) = 1/2 - t + t^2, \\ & \quad \dots \end{aligned}$$

Thus, the solution of the system is a polynomial functions whose degree increases with time. One can then see the time-delay system as an infinite dimensional system since the solutions of this time-delay system with a constant initial condition are a polynomial of infinite dimension.

Another property of time-delay systems to understand that this class of systems is of infinite dimension, is to consider the Laplace transform of equation (2.1). The characteristic equation is

$$s + e^{-hs} = 0$$

This characteristic equation, even though it is quite simple, has an infinite number of complex roots as shown in Figure 2.3. This remark also illustrates that time-delay systems are infinite dimensional systems.

Remark 2.1

The stability conditions based on the location of roots of the characteristic equation still holds, i.e. the stability is ensured if its roots have a negative real part (see [135] or [222] for more detailed explanations). These methods will not be discussed in this manuscript.

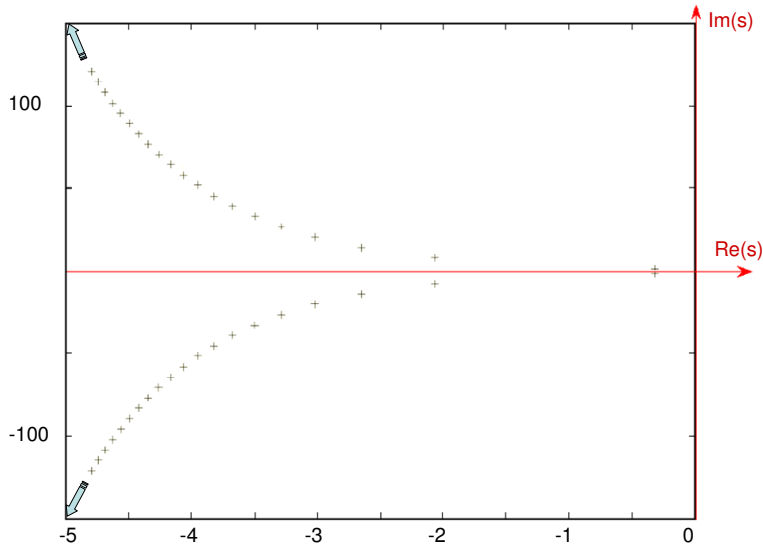

Figure 2.3: Solution for $h = 0, 1$ and constant and zero initial conditions

2.1.2 System and delay models

In this part, we will present the different types of delay systems encountered in the literature. We do not expose the Cauchy problem, initially studied by Mishkis [216]. The reader is referred to the works [29], [175] or [260] on the existence and uniqueness of solutions.

General representation of delayed systems

As we have said, delayed systems are dynamical systems governed by functional differential equations bearing both on current and past values in time. If we assume that the derivative of the state vector can be expressed at each time t , such systems are governed by differential equations of the form:

$$\begin{cases} \dot{x}(t) = f(t, x_t, u_t), \\ x_{t_0} = \phi(\theta), \quad \forall \theta \in [t_0 - h, t_0], \\ u_{t_0} = \zeta(\theta), \quad \forall \theta \in [t_0 - h, t_0], \end{cases} \quad (2.2)$$

where $h > 0$ and the functions x_t and u_t employ the Shimanov notation [317], which consists of the following definition

$$x_t : \begin{cases} [-h, 0] \rightarrow \mathbb{R}^n, \\ \theta \mapsto x_t(\theta) = x(t + \theta), \end{cases} \quad (2.3)$$

$$u_t : \begin{cases} [-h, 0] \rightarrow \mathbb{R}^n, \\ \theta \mapsto u_t(\theta) = u(t + \theta). \end{cases} \quad (2.4)$$

We will denote in the sequel $\mathcal{C} = \mathcal{C}^0([-h, 0], \mathbb{R}^n)$, the set of continuous functions from $[-h, 0]$ to \mathbb{R}^n . The function $x_t \in \mathcal{C}$ represents the state of the delay system at a time t , u_t is the (control or disturbance) input of the system. The initial conditions, denoted as ϕ and ζ at time t_0 , are functions from $[t_0 - h, t_0]$ to \mathbb{R}^n and are generally assumed to be continuous or piecewise continuous. Due to these features, delay systems belong to the class of infinite dimensional systems, since the state function x_t belongs to an infinite dimensional state.

Linear delay systems

In this chapter, we will focus on the case of linear delay systems. These systems can be seen as the linearized version of the general nonlinear class of systems presented in (2.2) around a local equilibrium. The most usual class of linear systems with delays is described by the following functional differential equation

$$\begin{cases} \dot{x}(t) = Ax(t) + A_d x(t-h), & \forall t \geq 0, \\ x(t) = \phi(t), & \forall t \in [-h, 0], \end{cases} \quad (2.5)$$

where $x(t) \in \mathbb{R}^n$ denotes the instantaneous state vector, ϕ is a function defined on the interval $[-h, 0]$ and represents the initial conditions of the system. The matrices A and A_d are, in the simplest case, assumed to be constant matrices.

Equation (2.5) refers to the case of linear continuous-time systems subject to a *discrete delay*, in the sense that only a discrete value of the state function x_t , i.e. $x(t-h)$ affects the dynamics of the system. As mentioned in the previous chapter, this class of systems appears in *Networked Control Systems* [153, 352], among many other application fields such as *Biology*, *Traffic Control* (see [101, 222, 261, 318] for more information) or tele-operated systems [64]. In this formulation, the delay h may be a constant scalar or a time-varying function. The usual assumption on the delay will be discussed in the next section. One may also face systems where several discrete values of the state function affect the current dynamics. In this situation, we are used to say that the system has multiple delays. The reader may refer to [57, 61, 81, 232, 319] to cite only few, in order to have an overview of the various methods for the stability analysis and control of this class of systems.

Another class of time-delay systems is the so-called distributed delay systems. It consists of dynamics where the whole state function x_t affects the current dynamics of the system. These systems can be modeled as follows

$$\begin{cases} \dot{x}(t) = Ax(t) + \int_{-h}^0 A_D(\theta)x(t+\theta)d\theta, & \forall t \geq 0, \\ x(t) = \phi(t), & \forall t \in [-h, 0], \end{cases} \quad (2.6)$$

where $x(t) \in \mathbb{R}^n$ is the state vector, $\phi \in \mathcal{C}([-h, 0] \rightarrow \mathbb{R}^n)$ is a continuous function, representing the initial conditions, A is constant matrix and A_D denotes a known continuous function of $L_2([-h, 0] \rightarrow \mathbb{R}^{n \times n})$ and represents the kernel of the distributed delay. Several applications follows this class of dynamics such as *combustion in rocket motor chambers* in [81], *population dynamics* with gamma-distribution [68], etc... This class of systems has been studied in a large number of papers (see [62, 90, 111, 212, 213, 302, 321, 343] to cite only few).

In order to cope with a larger class of systems, some uncertainties or disturbances may affect the previous dynamics. In this situation, the matrices A and A_d are not assumed to be known nor to be constant. The most common classes of uncertainties that have been considered in the literature are described below

Norm Bounded Uncertainties: In this situation, the matrices A and A_d are unknown and/or time-varying parameters but are assumed to satisfy the following condition

$$A = A_0 + E\Theta(t)F, A_d = A_{d0} + E_d\Theta(t)F_d,$$

where the matrices E, F, E_d, F_d , of appropriate dimension, are known and the uncertainties are captured in the uncertain matrix Θ , which verifies

$$\Theta^\top(t)\Theta(t) \leq \epsilon I,$$

where ϵ is a given parameter. This last equation justifies the name of norm-bounded uncertainties.

Polytopic Uncertainties: In this situation, the matrices A and A_d are assumed to belong to a polytope given by

$$[A \quad A_d] \in \text{Co}_{i=1, \dots, m} \{ [A^i \quad A_d^i] \}$$

where m is a positive integer, and the matrices A^i and A_d^i , where $i = 1, \dots, m$ are constant and known. This formulation implicitly refers to the existence of weighting scalar functions λ_i , for $i = 1, \dots, m$ that maps \mathbb{R} to $[0, 1]$, and such that $\sum_{i=1}^m \lambda_i(t) = 1$ and

$$[A \quad A_d] = \sum_{i=1}^m \lambda_i(t) [A^i \quad A_d^i].$$

In general, assessing stability of such classes of uncertain time-delay systems can be performed by simple tricks transforming stability conditions for a nominal linear delay system (2.5) to cope with these uncertainties. This manipulation relies generally on the convexity of the stability conditions with respect to the matrices A and A_d .

2.1.3 Usual assumptions on the delay functions

In this section, we will successively expose the various model of delays that can be found in the literature.

a) Constant delay functions: The first studies of time-delay systems concerned indeed the case of constant delay functions and was mainly carried out using frequency domain approaches. Indeed, one may look at several stability criteria applied to the Laplace transfer function (the reader may refer to the following books [135, 222]. Concerning the time-domain approach and the second Lyapunov method, numerous studies have been provided, see for instance [101, 172] to assess stability of linear systems with constant and known/unknown delays. Some of them are said delay-independent (see for instance [30, 31, 77, 185, 223, 344] among many others), meaning that the conditions does not depend on the value of the delay, or are delay-dependent (see for instance [90, 96, 97, 110, 109, 129, 143, 211, 345] among many others), meaning here that the condition may be guaranteed only for some values of the delay. Since the 90's, an explosion of the number of stability criteria within the time domain approach have been made possible thanks to the developments of semi-definite programming, allows to find solutions to Linear Matrix Inequalities in a simple and efficient manner, for instance on Matlab [84, 114, 180, 193, 257, 150, 236, 335]. For instance, one may have a look at [176, 184] and [222, 135] to find the first contributions in this direction.

b) Bounded time-varying delays: In practical application, the assumption of having constant delays becomes to restrictive. In particular in Networked Control Systems applications (see for

instance [153, 194, 352]), delay may arise from the communication through unreliable (wireless) networks. For instance, congestion in the network and the packet loss phenomenon may lead to non negligible variations on the delay functions.

In such situations, researchers consider delay functions that verify the following assumption [159]. There exists a positive scalar $h_2 > 0$ such that:

$$0 \leq h(t) \leq h_2. \quad (2.7)$$

Some authors also include some additional conditions on the derivative of the delay functions in order to ensure causality and regularity. This will be described in the next paragraph. If no additional constraints on the derivative of the delay function is required, several authors denotes this class of delay function as *fast-varying delays* [105]. This class of delay functions are of particular interests, notably for sampled-data and/or networked control systems.

c) Interval or Non small delays: Again, in the context of networked control systems or in some application such as in [10], the previous assumption may be too restrictive, since the delay functions are allowed to reach zero (i.e. system without delay), while, from the application point of view, this would be that the transport of the information or more generally of the quantity of interest may be achieved with a arbitrarily fast velocity. However in some applications, this velocity is limited and therefore, there is a minimal time before the current quantity of interest is available to the controller or to the system.

Hence, the assumption saying that the delay functions belong to an interval of the form $[0, h_2]$ becomes too restrictive and the associated stability analysis may lead to inherent conservatism. One can then define interval or non small delay functions that prevent the delay functions to be equal or too close to zero. The assumption on the delay functions is related to the existence of two positive scalars $0 < h_1 \leq h_2$ such that

$$0 < h_1 \leq h(t) \leq h_2. \quad (2.8)$$

The first results in this direction were developed in [98, 99, 106], or in [162, 163]. The method proposed in these papers consists in rewriting the delay function as the sum of a constant and known delay equal, for instance h_1 or $(h_1 + h_2)/2$ and of the residual time-varying function. The first constant delay term can be seen as the nominal delay while the second term represents the variation or the disturbance with respect to this nominal constant delay.

d) Delay functions with constrained derivatives A large number of papers addressing the stability systems subject to time-varying delays require additional assumptions on the delay functions. It generally comes from the differentiation of integral terms considered over interval of the form $[t, t - h(t)]$ or $[t - h(t), t - h_2]$. Historically, the first contributions in this direction require the following condition (see for instance [109, 108])

$$\dot{h}(t) \leq d < 1. \quad (2.9)$$

Looking more into the details of this assumption, the previous condition imposes that the function $f(t) = t - h(t)$, representing the evolution of the delayed information with respect to time, is strictly increasing and consequently bijective. From the engineering point of view, this

assumption means that the delayed information or the quantity of interest affect the systems following a chronological order.

Another usual assumption arising from the recent developments on the stability analysis of systems subject to time-varying delays is provided below.

$$d_1 \leq \dot{h}(t) \leq d_2. \quad (2.10)$$

Here, the upper bound d_2 is not necessarily strictly smaller than 1 [296]. This assumption is required when the resulting stability conditions depends linearly on the derivative of the delay functions. Thus this assumption is considered to include more constraints to the allowable delay function.

e) Piecewise continuous delay functions: This situation is relevant when one has to face with networked control systems where the information may travel among several communication channels. In this situation, the delay function may be affected by a brutal modification of channel, leading to a discontinuity in the delay function. Another relevant motivation of this class of delay functions is concerned with the stability analysis of sampled-data systems (see [105]) where the effects of a periodic or aperiodic sampling can be modeled as a discontinuous delay function, which, in addition, verifies the following constraint on its derivative

$$\dot{h}(t) \leq 1. \quad (2.11)$$

Coming back to the comments provided on assumption d), this assumption makes that the function $f(t) = t - h(t)$ can be constant. This means that the information is held while the delay verifies $\dot{h}(t) = 1$, which corresponds indeed to the effect of a sampling.

2.2 Stability of time-delay systems using the Second Lyapunov Method

In this section, we recall some results assessing the asymptotic stability of delay systems by focusing on a time-domain approach related to the second method of Lyapunov.

2.2.1 Second Lyapunov method

Let us consider the generic time-delay system given by

$$\begin{aligned} \dot{x}(t) &= f(t, x(t), x_t), \quad \forall t \geq 0 \\ x_0(\theta) &= \phi(\theta), \quad \forall \theta \in [-h, 0], \end{aligned} \quad (2.12)$$

for which we assume the existence and uniqueness of solutions and, without loss of generality, the solution $x_t = 0$ is an equilibrium.

2.2.2 Lyapunov-Razumikhin approach

In this approach, the goal is to consider a classical Lyapunov function $V(t, x(t))$, as the one employed for the delay-free case (i.e. for ordinary differential equations). The main idea of the Lyapunov-Krasovskii theorem is that it is not necessary to ensure the negative definiteness of $\dot{V}(t, x(t))$ along

all the trajectories of the system. Indeed, it is sufficient to ensure its negative definiteness only for the solutions that tend to escape the neighborhood of $V(t, x(t)) \leq c$ of the equilibrium. This idea is formalized in the following theorem [175].

Theorem 2.1

Let u, v and $w : \mathbb{R}_+ \rightarrow \mathbb{R}_+$ be nondecreasing functions such that $u(\theta)$ and $v(\theta)$ are strictly positive for all $\theta > 0$. Assume that the vector field f of (2.12) is bounded for bounded values of its arguments.

If there exists a continuous and differentiable function $V : \mathbb{R} \times \mathbb{R}^n \rightarrow \mathbb{R}_+$ such that:

- a) $u(\|\phi(0)\|) \leq V(t, \phi) \leq v(\|\phi\|)$,
- b) $\dot{V}(t, \phi) \leq -w(\|\phi(0)\|)$ for all trajectories of (2.12) satisfying:

$$V(t + \theta, \phi(t + \theta)) \leq V(t, \phi(t)), \quad \forall \theta \in [-h, 0], \quad (2.13)$$

then the solution $x_t = 0$ is uniformly stable for (2.12).

Moreover, if $w(\theta) > 0$ for all θ and there exists a strictly increasing function $p : \mathbb{R}_+ \rightarrow \mathbb{R}_+$ such that $p(\theta) > \theta$ for all $\theta > 0$ and

- i) $u(\|\phi(0)\|) \leq V(t, \phi) \leq v(\|\phi\|)$,
- ii) $\dot{V}(t, \phi) \leq -w(\|\phi(0)\|)$, for all trajectories of (2.12) verifying:

$$V(t + \theta, x(t + \theta)) \leq p(V(t, x(t))), \quad \forall \theta \in [-h, 0], \quad (2.14)$$

then such a function V Lyapunov-Razumikhin function and solution $x_t = 0$ is uniformly asymptotically stable for system (2.12).

In practice, the functions p are usually considered as $p = q\theta$ where q is a constant strictly greater than 1. Moreover, Lyapunov functions more commonly employed in the Razumikhin approach are of the form

$$V(t) = x^\top P x(t), \quad (2.15)$$

where P is a symmetric positive definite matrix of dimension n , the dimension of $x(t)$. Equation (2.14) thus becomes

$$x^\top(t + \theta) P x(t + \theta) \leq q x^\top(t) P x(t), \quad \forall \theta \in [-h, 0], \quad \text{and} \quad q > 1. \quad (2.16)$$

Although the Lyapunov-Razumikhin approach generally leads to more conservative results than those based on the Lyapunov-Krasovskii theorem, presented in the next paragraph, it allows taking into account variable delays without restriction on derivative of the delay function (2.9) and generally leads to delay-independent stability conditions. It has also been shown that for constant delays, the existence of a Lyapunov-Razumikhin function is equivalent to the existence of a Lyapunov-Krasovskii functional [80].

2.2.3 Lyapunov-Krasovskii approach

The Lyapunov-Krasovskii method is an extension of the second Lyapunov method dedicated to the stability analysis of functional differential equations. It consists in selecting “energy” functionals, i.e. (functions of the functional state x_t) of the form $\mathcal{V}(t, x_t)$, that are positive definite and decreasing along the trajectories of system (2.12). The Lyapunov-Krasovskii theorem is stated below [175].

Theorem 2.2

Let u, v and $w : \mathbb{R}_+ \rightarrow \mathbb{R}_+$ be continuous and increasing functions such that $u(\theta)$ et $v(\theta)$ are strictly positive for all $\theta > 0$ and $u(0) = v(0) = 0$. Assume that the vector field f of (2.12) is bounded for all bounded values of its arguments.

If there exists a continuous and differentiable functional $\mathcal{V} : \mathbb{R} \times C \rightarrow \mathbb{R}_+$ such that:

- a) $u(\|\phi(0)\|) \leq \mathcal{V}(t, \phi) \leq v(\|\phi\|)$,
- b) $\dot{\mathcal{V}}(t, \phi) \leq -w(\|\phi(0)\|)$ for all $t \geq t_0$ along the trajectories of (2.12), where $\dot{\mathcal{V}}(t, \phi)$ denote here the derivative of V in the Dini sense, i.e. $\dot{\mathcal{V}}(t, \phi) = \lim_{\epsilon \rightarrow 0^+} \sup \frac{\mathcal{V}(t+\epsilon, x_{t+\epsilon}) - \mathcal{V}(t, x_t)}{\epsilon}$.

Then the solution $x_t = 0$ of (2.12) is uniformly stable. Moreover, if $w(\theta) > 0$ for all $\theta > 0$, then the solution $x_t = 0$ is uniformly asymptotically stable for system (2.12).

Such a functional is called a Lyapunov-Krasovskii functional.

The main idea behind the statement of this theorem is to determine a positive definite functional \mathcal{V} , such that its derivative with respect to time along the trajectories of the system (2.12) is negative definite. The main problem within the application of this theorem is the design functional and then to provide some conditions that guarantee its positive definiteness and the negative definiteness of its derivative

The derivation of stability conditions using Lyapunov-Krasovskii functionals usually involves quite elaborate developments. To give an idea of the procedure involved in this approach and to provide a glimpse of its technical flavor, we present here some basics on the procedure to follow in order to derive asymptotic stability criteria for time-delay systems expressed in terms of Linear Matrix Inequality (LMI). Based on elementary considerations, we expose the main difficulties and the most relevant tools. The basic steps for deriving constructive stability conditions are illustrated as follows.

Step 1. *Propose a candidate Lyapunov-Krasovskii functional V .* The Lyapunov-Krasovskii functional that is necessary and sufficient for the stability of LTI systems with delay has a rather complex form, even for the case of constant delays [175]. Let us provide a non-exhaustive list of usual terms that are employed in the literature

- *Complete Lyapunov-Krasovskii functionals:*

$$\begin{aligned} \mathcal{V}(t, x_t) = & x_t^\top(0) P x_t(0) + 2x_t^\top(0) \left(\int_{-h}^0 \mathcal{Q}(s) x_t(s) ds \right) \\ & + \int_{-h}^0 \int_{-h}^0 x_t^\top(s) \mathcal{T}(s, \theta) x_t(\theta) ds d\theta + \int_{-h}^0 x_t^\top(s) (S + (h+s)R) x_t(s) ds, \end{aligned} \quad (2.17)$$

where the matrices $P = P^\top$, $R = R^\top$ and $S = S^\top$ and the matrix functions Q and \mathcal{T} are matrices of appropriate dimension. The matrices function T also verifies $T(s, \theta) = T^\top(\theta, s)$.

Behind the complexity of the formulation, there are several interests of employing such a functionals. First of all, it is easy to see that when the delay h tends to zero, one recovers the classical quadratic function usually employed for linear time invariant systems. A second and notable interest of this functional has been demonstrated in [173]. In this paper, it is shown that a linear system subject to a constant delay is asymptotically stable if and only if it admits a Lyapunov-Krasovskii functional that have exactly the same form as in (2.17), where the parameters P, Q, R, S, \mathcal{T} are derived from the solution of matrix partial differential equations. Unfortunately, this notable result only provides the existence of the Lyapunov-Krasovskii functional but does not provide a method to construct those parameters from a numerical point of view. Therefore this method can not be directly applied to assess stability of time-delay systems. An attempt in this direction was proposed by K. Gu in [132, 134, 135] using a discretization process on the delay interval in which the parameters are, to stay short, affine functions of the integration variables. The resulting stability conditions are expressed in terms of LMI. In [238, 247, 248], another method was proposed based on polynomial parameters, that successfully address the asymptotic stability of time-delay systems through the SoS of Squares framework [245, 246, 253].

A notable aspect of these two methods is that the objective is finally to derive a numerical test to approximate the parameters of the Complete Lyapunov-Krasovskii functionals. Since in both methods, letting the number of discretization or the degree of the polynomials tend to infinity lead to a good approximation of those parameters. Notably, a discussion on the conservatism of the polynomial method was discussed in [247], leading potentially to a non conservative test. Nevertheless, these two resulting stability conditions have drawbacks. Their complexity in terms of implementation and of number of decision variables made these method not “user-friendly” and many researchers of the fields were looking for simpler Lyapunov-Krasovskii functionals (see for instance [177]), leading to simplified stability conditions.

- *Delay-independent Lyapunov-Krasovskii functionals:*

$$V_0(x_t) = x_t^\top(0)Px_t(0) + \int_{-h}^0 x_t^\top(s)Sx_t(s)ds.$$

This functional can be compared with (2.17), by setting the parameters Q, \mathcal{T} and R to zero. The specifications delay-independent comes from the fact that, when deriving stability conditions from this functional, the resulting conditions does not depend on the value of the delay h . Hence, if the condition holds, it implies that the system remains stable for any values of the delay.

Of course this functional leads to conservative results since a large class of the delay systems may be stable only for some values of the delay. This is the reason why several study have considered functionals leading to delay-dependent conditions

- *Delay-dependent Lyapunov-Krasovskii functionals:*

$$V(x_t, \dot{x}_t) = x_t^\top(0)Px_t(0) + \int_{-h}^0 x_t^\top(s)Sx_t(s)ds + h \int_{-h}^0 \int_{\theta}^0 \dot{x}_t^\top(s)R\dot{x}_t(s)dsd\theta \quad (2.18)$$

or equivalently

$$V(x_t, \dot{x}_t) = x_t^\top(0)Px_t(0) + \int_{-h}^0 x_t^\top(s)Sx_t(s)ds + h \int_{-h}^0 (h+s)\dot{x}_t^\top(s)R\dot{x}_t(s)ds$$

where the matrices P, S and R are symmetric positive definite. This class of functionals, introduced in in [107], is richer than the delay-independent functional and includes many types of functionals. The novelty in the definition of this functional relies on the last terms, which depends on $\dot{x}_t(s) = \frac{d}{dt}x(t+s)$. This functional does not exactly meets the requirement of the Lyapunov-Krasovskii theorem since this theorem does not mention the possibility for a functional to have \dot{x}_t as an argument. Nevertheless, extensions of the Lyapunov-Krasovskii theorem including this particularity has been investigated and is now admitted (see, for instance [101, Section 3.1.2]).

- *Multiple integral functionals:*

$$V_m(\dot{x}_t) = \frac{h^2}{2} \int_{-h}^0 \int_{\theta_1}^0 \int_{\theta_2}^0 \dot{x}_t^\top(s)R_m\dot{x}_t(s)dsd\theta_2d\theta_1 \quad (2.19)$$

or equivalently

$$V_m(\dot{x}_t) = \frac{h^2}{2} \int_{-h}^0 (h+s)^2 \dot{x}_t^\top(s)R_m\dot{x}_t(s)ds$$

where the matrix R_m is positive definite. This functional was considered. This class of functionals, introduced in [326] provided new possibilities to enrich the functional by many terms. In order to be efficient, from the numerical point of view, these functionals require generally the introduction of an additional quadratic term which depends on $\int_{-h}^0 x_t(s)ds$ or on $\int_{-h}^0 \int_{\theta}^0 x_t(s)dsd\theta$. Many extensions to more general multiple integral functional have been considered in the literature and have led to some numerical improvements (see, for instance, [88, 239], among many others).

- *Delay partitioning/decomposition functionals:*

$$V_m(x_t) = h \int_{-h/2}^0 \begin{bmatrix} x_t(s) \\ x_t(s-h/2) \end{bmatrix}^\top R_m \begin{bmatrix} x_t(s) \\ x_t(s-h/2) \end{bmatrix} ds \quad (2.20)$$

Following the idea of the discretization method provided by K. Gu in [132, 134, 135], several researches turns to enrich the functional with intermediate values of the state function. Indeed in the previous functional, one can see the introduction of the term $x_t(-h/2)$. As for the discretization method, this method allows to refines the resulting stability conditions by taking into account more and more information on the state function x_t . Several contributions towards this direction were proposed [131, 140, 362, 354, 91] among many other. It is worth mentioning that the analysis of reduction of the conservatism was studied in [40, 131].

To conclude on the selection of the candidate for being a good Lyapunov-Krasovskii functionals, the previous discussion show that much efforts have been dedicated to the construction of more and more evolved functionals. Except for the discretization and the delay partitioning methods, in most of the case, the main procedure is to follow the paradigm “try and check”, meaning that researchers were

developing and introducing more and more terms to be included in the functional and have followed the procedure to derived “good” stability conditions. There was no clear vision and explanation on what is a good functional for a time-delay system. This question consisting in finding a good candidate still represents an open question, on which we are trying to provide an answer.

Step 2. Compute the derivative of V .

For the functional (2.18) this leads to

$$\begin{aligned} \dot{V}(x_t, \dot{x}_t) = & 2\dot{x}_t^\top(0)Px_t(0) + x_t^\top(0)Sx_t(0) - x_t^\top(-h)Sx_t(-h) \\ & + h^2\dot{x}_t^\top(0)R\dot{x}_t(0) - h \int_{t-h}^t \dot{x}_t^\top(s)R\dot{x}_t(s)ds. \end{aligned} \quad (2.21)$$

The idea is then to rewrite this expression as a quadratic form expressed using all the relevant information on the state function, corresponding to the “LMization” of the expression of $\dot{V}(x_t, \dot{x}_t)$. The relevant information are in this situation composed by $x_t(0)$, $\dot{x}_t(0)$ and $x_t(-h)$. First, we note that there exists a redundancy in these three vectors by noting that $\dot{x}_t(0) = Ax_t(0) + A_d x_t(-h)$, in the case of a linear delay systems. One can either replace $\dot{x}_t(0)$ by its expression or one may also keep this information and use the descriptor formulation [107] or introduce slack variables [144]. Note that in the case of constant and know matrices A and A_d , all these approaches lead to equivalent results (see [129] for more details).

Step 3. Over-approximate the integral terms.

Note that in (2.21), the last integral term cannot be straightforwardly converted in the quadratic formulation described above. Indeed the problem comes from the last negative integral term $-\int_{-h}^0 \dot{x}_t^\top(s)R\dot{x}_t(s)ds$, which is an impediment to the analysis of the sign of (2.21). Such terms are common in the derivative of Lyapunov-Krasovskii functionals and they need to be included using over-approximation methods. This procedure is applied in order to replace the integral terms by more simple expressions, that can be expressed in a quadratic form to be included in the previous formulation.

In the sequel, we will call this procedure as the use of *integral inequalities*. Unavoidably, using such integral inequalities introduces some conservatism in the analysis and consequently in the resulting stability conditions. In the next section, we will review the existing methods, which have been employed in the literature.

2.3 Integral inequalities and time-delay systems

Following the discussion on the methodology to derive stability conditions for time-delay systems and the steps of the procedure described in the previous section, the objective of this section is to provide generic tools that enable the “LMization” process, which consists, again, in transforming the previous expression in a more appropriate form to obtain an LMI formulation of the stability conditions. Indeed this step is crucial and, consequently, has to be studied carefully. In the following, we will consider the problem of providing integral inequalities which deliver a lower bound of an integral quadratic term of the form

$$\int_{-h}^0 x_t^\top(u)Rx_t(u)du \quad \text{or} \quad \int_{-h}^0 \dot{x}_t^\top(u)R\dot{x}_t(u)du$$

where h is a positive scalar. In the sequel, a review of existing integral inequalities that have been recently employed in the context of time-delay systems will be provided.

Remark 2.2

For simplicity, the next developments will mainly focus on the derivation of lower bounds for the left-hand side integral of the previous equation. We will also show methods to extend these first results to the right-hand side integral.

2.3.1 Jensen's inequality

The first method to treat this problem is based on the Jensen's inequality formulated below

Lemma 2.1

For a given $n \times n$ -matrices $R \succ 0$ and for any piecewise continuous function x in $[-h, 0] \rightarrow \mathbb{R}^n$, the following inequality holds:

$$\int_{-h}^0 x^\top(u) R x(u) du \geq \frac{1}{h} \Omega_0^\top(x) R \Omega_0(x) \quad (2.22)$$

where $\Omega_0(x) = \int_{-h}^0 x(u) du$.

The proof is omitted and can be found in several reference books [135]. Naturally, Jensen's inequality is likely to entail some inherent conservatism. Several works have been devoted to the reduction of associated conservatism using the discretization of the delay interval [40, 131].

In the next section we propose to use an alternative solution to reduce the inherent conservative of this inequality using two class of well-established inequalities. The first one refers to the so-called Wirtinger's inequalities issues from the Fourier analysis. The second one is a particular interpretation of the Bessel's inequality on Hilbert space.

2.3.2 Wirtinger-based integral inequality**Wirtinger inequalities**

In the literature [164], Wirtinger's inequalities refer to inequalities which estimate the integral of the derivative function with the help of the integral of the function. Wirtinger's inequality have already been widely used in Automatic Control. To cite only few works, one may look at [178, Chapter 15], and at [104] in the context of *Distributed Parameter Systems* or in [190] for *Sampled-Data Systems*. Often proved using Fourier analysis, there exist several versions which depend on the characteristics or constraints we impose on the function. Let us focus on the following Wirtinger's inequality adapted to our purpose.

Lemma 2.2

Consider a given $n \times n$ -matrix $R \succ 0$. Then, for all function z in $\mathcal{C}^1([-h, 0] \rightarrow \mathbb{R}^n)$ which satisfies $z(0) = z(-h) = 0$, the following inequality holds

$$\int_{-h}^0 \dot{z}^\top(u) R \dot{z}(u) du \geq \frac{\pi^2}{h^2} \int_{-h}^0 z^\top(u) R z(u) du, \quad (2.23)$$

Proof: The proof is omitted but can be found in [164]. \diamond

It is worth noting that this inequality is not related to the Jensen's inequality in its essence. Indeed, the function z has to meet several constraints whereas the function x is assumed to be a continuous function in the Jensen's inequality. The next section shows how to create a relation between them.

Application of the Wirtinger's inequalities: First version [294]

The objective of this section is twofold. On the first hand, we aim at providing new tractable inequalities based on Lemma 2.2, which can be easily implemented into a convex optimization scheme. On the other hand, we propose an inequality which is proved to be less conservative than Jensen's one. Thus a first step consists in defining an appropriate function z such that this integral appears naturally in the developments. Thus a necessary condition is that the function z has the following form

$$z_W(u) = \int_{-h}^u x(s) ds - y(u), \quad (2.24)$$

where x is a continuous function in $[-h, 0] \rightarrow \mathbb{R}^n$ as defined in the Jensen's inequality and y is a function of u to be defined and are chosen so that the function z meets the different constraints imposed by Lemma 2.2. Following this idea, the next lemma is provided ([294]).

Lemma 2.3

Let R be a positive definite matrix of \mathcal{S}^n . Then, for any continuous function x in $[-h, 0] \rightarrow \mathbb{R}^n$ the following inequality holds:

$$\int_{-h}^0 x^\top(u) R x(u) du \geq \frac{1}{h} \begin{bmatrix} \Omega_0(x) \\ \Omega_1(x) \end{bmatrix}^\top \begin{bmatrix} R & \\ & \frac{\pi^2}{4} R \end{bmatrix} \begin{bmatrix} \Omega_0(x) \\ \Omega_1(x) \end{bmatrix} \quad (2.25)$$

where

$$\begin{aligned} \Omega_0(x) &= \int_{-h}^0 x(u) du \\ \Omega_1(x) &= \int_{-h}^0 x(u) du - \frac{2}{h} \int_{-h}^0 \int_{-h}^u x(s) ds du \end{aligned}$$

Proof: For any continuous function x from $[-h, 0]$ to \mathbb{R}^n , define the function z_{W1} given by

$$z_{W1}(u) = \int_{-h}^u x(s) ds - \frac{u+h}{h} \int_{-h}^0 x(s) ds = \int_{-h}^u x(s) ds - \frac{u+h}{h} \Omega_0(x), \quad \forall u \in [-h, 0].$$

The second term is a polynomial of degree 1 which compensates the first term when $u = 0$. By construction, the function $z_{W1}(u)$ meets the conditions of the Wirtinger's inequality given in

Lemma 2.2, that is $z_{W_1}(-h) = z_{W_1}(0) = 0$. We also note that the function z_{W_1} admits a continuous derivative with respect to the variable u , which is given by

$$\dot{z}_{W_1}(u) = x(u) - \frac{1}{h}\Omega_0(x), \quad \forall u \in [-h, 0].$$

This function z_{W_1} has also been defined such that the computation of \dot{z}_{W_1} makes appear the original function x as suggested in equation (2.24). The computation of the left-hand-side of the inequality stated in Lemma 2.2 leads to:

$$\int_{-h}^0 \dot{z}_{W_1}^\top(u) R \dot{z}_{W_1}(u) du = \int_{-h}^0 x^\top(u) R x(u) du - \frac{1}{h} \Omega_0^\top(x) R \Omega_0(x) \quad (2.26)$$

Remark 2.3

At this step, one can already find an alternative proof of the Jensen's inequality. Indeed, since the matrix R is assumed to be symmetric positive definite, the left-hand-side of (2.26) is positive definite, which ensures the following inequality

$$0 \leq \int_{-h}^0 \dot{z}_{W_1}^\top(u) R \dot{z}_{W_1}(u) du = \int_{-h}^0 x^\top(u) R x(u) du - \frac{1}{h} \Omega_0^\top(x) R \Omega_0(x).$$

We already note that this inequality is exactly the Jensen's inequality in Lemma 2.1.

Consider the right-hand side of the inequality (2.23). Applying the Jensen's inequality, we have

$$\frac{\pi^2}{h^2} \int_{-h}^0 z_{W_1}^\top(u) R z_{W_1}(u) du \geq \frac{\pi^2}{h^3} \left(\int_{-h}^0 z_{W_1}(u) du \right)^\top R \left(\int_{-h}^0 z_{W_1}(u) du \right), \quad (2.27)$$

where simple calculations show that

$$\int_{-h}^0 z_{W_1}(u) du = \left(\int_{-h}^0 \int_{-h}^u x(s) ds du - \frac{h}{2} \int_{-h}^0 x(u) du \right) = -\frac{h}{2} \Omega_1(x).$$

The proof is concluded by application of the Wirtinger's inequality in Lemma 2.2 which ensures

$$\int_{-h}^0 x^\top(u) R x(u) du - \frac{1}{h} \Omega_0^\top(x) R \Omega_0(x) \geq \frac{\pi^2}{4h} \Omega_1^\top(x) R \Omega_1(x).$$

◇

Several comments on this new inequality can already be done. In light of Remark 2.3, the Wirtinger inequality provides a method to obtain a more accurate lower bound of the integral

$$\int_{-h}^0 x^\top(u) R x(u) du.$$

Indeed, since R is positive definite, the term $\frac{\pi^2}{4h} \Omega_1^\top(x) R \Omega_1(x)$ is also positive, showing that Lemma 2.3 is less conservative than the Jensen's inequality. A second comment concerns the introduction of a new information $\Omega_1(x)$ which depends on the function x . As shown in [294] (and latter on in this chapter), a particular attention has to be paid on this term when one wants to use in inequality to derive stability condition for time-delay systems.

Application of the Wirtinger's inequalities: Second version

In this section, we propose to refine and precise this first Wirtinger-based integral inequality. To do so, we will consider again a function z as defined in (2.24). This will lead to the following Lemma which was presented in [296].

Lemma 2.4

Consider a given matrix $R \succ 0$. Then, for all continuous function x in $[-h, 0] \rightarrow \mathbb{R}^n$ the following inequality holds:

$$\int_{-h}^0 x^\top(u) R x(u) du \geq \frac{1}{h} \begin{bmatrix} \Omega_0(x) \\ \Omega_1(x) \end{bmatrix}^\top \begin{bmatrix} R & \\ & 3R \end{bmatrix} \begin{bmatrix} \Omega_0(x) \\ \Omega_1(x) \end{bmatrix} \quad (2.28)$$

where

$$\begin{aligned} \Omega_0(x) &= \int_{-h}^0 x(u) du \\ \Omega_1(x) &= \int_{-h}^0 x(u) du - \frac{2}{h} \int_{-h}^0 \int_{-h}^u x(s) ds du \end{aligned}$$

Remark 2.4

This new lemma takes the same formulation as in Lemma 2.3 but only a coefficient in the right-hand side has been modified. Indeed compared to Lemma 2.3, the coefficient $\pi^2/4$ is replaced by a greater value, 3. Therefore, the lower bound of the integral provided in this new version is less conservative.

Proof: Following the proof of Lemma 2.3, we introduce a new function z_{W2} defined for any continuous function x , given by define the function z given by

$$z_{W2}(u) = \int_{-h}^u x(s) ds - \frac{u+h}{h} \Omega_0(x) - \frac{u(u+h)}{h^2} \Theta, \quad \forall u \in [-h, 0]. \quad (2.29)$$

where Θ is a constant vector of \mathbb{R}^n to be defined. The difference between z and the one proposed in [294] appears in the third term. This last term is a polynomial term of degree 2, which becomes zero when $u = -h$ and $u = 0$. Again, by construction, the function $z_{W2}(u)$ meets the requirements conditions of the Wirtinger's inequality given in Lemma 2.2, that is $z(a) = z(b) = 0$.

Then following the same procedure as in Lemma 2.4, we first note that the derivative of z with respect to u is given by

$$\dot{z}_{W2}(u) = x(u) - \frac{1}{h} \Omega_0(x) - \frac{h+2u}{h^2} \Theta, \quad \forall u \in [-h, 0].$$

Then we expand the expression of $\int_{-h}^0 \dot{z}_{W2}^\top(u) R \dot{z}_{W2}(u) du$ and on the other side we apply the Jensen inequality to $\int_{-h}^0 z_{W2}^\top(u) R z_{W2}(u) du$. After performing several calculations of integral and integrations by parts (the details can be found in [296]), the following inequality is derived

$$\int_{-h}^0 x^\top(u) R x(u) du - \frac{1}{h} \Omega_0^\top(x) R \Omega_0(x) - \frac{3}{h} \Omega_1^\top(x) R \Omega_1(x) \geq \left(\frac{\pi^2 - 12}{36h} \right) (\Theta - 3\Omega_1(x))^\top R (\Theta - 3\Omega_1(x)).$$

Since $12 \geq \pi^2$ and $R \succ 0$, the right-hand side of the previous inequality is non positive independently of the choice of Θ . Hence, its maximum is reached and is zero when selecting $\Theta = 3\Omega_1(x)$, which concludes the proof. \diamond

2.3.3 Extension of the Wirtinger-based inequalities

Compared to the existing contributions within the stability analysis of time-delay systems, the Wirtinger-based integral inequality can be seen as an alternative solution of the discretization or the partition of the delay interval. The main interests of this inequality are described below.

- **Wirtinger-based inequality instead of Jensen's inequality:** Since the Wirtinger-based integral inequality has a similar structure as the Jensen's inequality, it is somehow easy to extend the analysis of various classes of time-delay systems, for instance, *uncertain systems, fuzzy systems, Lur'e systems, neural networks, systems with input saturations*, or various classes of control problems such as *exponential stability, stabilization, optimal control*, etc...
- **Further improvements on integral inequalities:** The conservatism of stability conditions for time-delay systems employing the Jensen's inequality was already pointed out in the 2000's. For a long time, the only method to reduce the conservatism of these analysis was to employ a discretization method, a delay-partitioning approach, to augment the model a state augmentation or to introduce additional terms in the Lyapunov-Krasovskii functional in a heuristic manner (i.e. "try and check"). The Wirtinger-based integral inequality provides a new direction for the reduction of the conservatism. Several researches turn out to provide less conservative integral inequalities that refines this new results. On a first hand, one may look at the *Auxiliary-function based integral inequality* in [244], the *free-matrix-based integral inequality* in [353], the *Wirtinger-based double integral inequality* [240] or in [174, 59] and the *Bessel-Legendre inequality* [297, 298, 302, 139]. Details and explanation on the last method will be provided in the following section, that gives an alternative and more accurate vision of this inequality and also generalizes its concept.
- **Summation inequalities for discrete systems with delays:** On the other hand, a summation version of the Jensen's inequality has been widely employed in the literature to assess stability of discrete-time systems with time-delay. Therefore, the Wirtinger-based integral inequality gave also a motivation to translate this integral inequality into the discrete-time domain. Indeed new *summation inequalities* have been derived in [304, 364, 138, 221] or in [58] and have led to less conservative stability conditions on various class of discrete-time-delay systems.

2.3.4 Bessel-Legendre inequality on Hilbert spaces

In the previous section, we have shown that increasing the degree of the polynomial function in z_{W1} allows a reduction of the conservatism of the resulting integral inequality. In this section, we aim at providing a method that pursues this idea of increasing the degree of the polynomial terms. However, at this stage, there is no obvious method that allows generalizing this method and to select in an accurate manner a "good" sequence of polynomials and the right "additional signals", which will be denoted as $\Omega_i(x)$, for $i = 2, 3, \dots$. In this section, we aim at presenting a method to extend, in a generic manner, the Wirtinger-based integral inequality and to provide less and less conservative

integral inequalities. This method is based on the Bessel's inequality on Hilbert Space and on the sequence of Legendre polynomials. A motivation of this solution is provided hereafter.

Preliminaries

In this section, we will present an general integral inequality that can be interpreted as the Bessel inequality on Hilbert spaces. In order to fully understand this vision, let us recall a technical detail in the proof of the first Wirtinger-based integral inequality presented in Lemma 2.3. In this proof, a remark on equation (2.26) mentioned that an alternative proof of the Jensen's inequality than the usual one. Let us first recall this equation with the particular selection of $R = I$ to simplify the next developments. After some calculations we obtained the following equation

$$\int_{-h}^0 |z_0(u)|^2 du = \int_{-h}^0 |x(u)|^2 du - \frac{1}{h} \left| \int_{-h}^0 x(u) du \right|^2 \quad (2.30)$$

where $z_0(u) = x(u) - \frac{1}{h} \int_{-h}^0 x(u) du$, $\forall u \in [-h, 0]$. The function z_0 can be interpreted as the difference between the function x under consideration and its average over the interval $[-h, 0]$. It can be also rewritten in the following form

$$z_0(u) = x(u) - \mathcal{L}_0^*(u) \int_{-h}^0 \mathcal{L}_0^*(u) x(u) du, \quad \forall u \in [-h, 0],$$

where $\mathcal{L}_0^*(u) = \left(\int_{-h}^0 1 ds \right)^{-1/2} = h^{-1/2}$ is the constant function of $\mathcal{C}([-h, 0])$, which is normalized

with respect to the inner product defined on the set of $\mathcal{C}([-h, 0], \mathbb{R}^n)$ by $\langle f, g \rangle := \int_{-h}^0 f(u)g(u)du$ for any continuous functions f and g in $\mathcal{C}([-h, 0], \mathbb{R}^n)$. In light of this expression, one can see that the vector z_0 represent the difference between the function x and its projection, in the sense of the integral inner product to the set of constant function. The norm associated to this inner product is defined by

$$\|x\|_{\mathcal{C}}^2 = \int_{-h}^0 x^\top(s)x(s)ds, \quad \forall x \in \mathcal{C}([-h, 0], \mathbb{R}^n). \quad (2.31)$$

and we can rewrite (2.30) as follows

$$\|x - \mathcal{L}_0^*(u) \langle \mathcal{L}_0^*, x \rangle\|_{\mathcal{C}}^2 = \|z_0\|_{\mathcal{C}}^2 = \|x\|_{\mathcal{C}}^2 - \langle \mathcal{L}_0^*, x \rangle^2 \geq 0 \quad (2.32)$$

with the light abuse of notation consisting in denoting

$$\langle \mathcal{L}_0^*, x \rangle = \int_{-h}^0 \mathcal{L}_0^*(u) x(u) du = \sqrt{\frac{1}{h}} \int_{-h}^0 x(u) du \quad \left(= \sqrt{\frac{1}{h}} \Omega_0(x) \right)$$

Following this framework, the Jensen's inequality, which can be summarized as $\|x\|_{\mathcal{C}}^2 - \langle \mathcal{L}_0^*, x \rangle^2 \geq 0$, can be interpreted in two manners. The first one is related to the Cauchy-Schwartz inequality. Another and more interesting interpretation relies on graphical considerations. It consists in noting that the inequality $\|x\|_{\mathcal{C}}^2 \geq \langle \mathcal{L}_0^*, x \rangle^2$, means that the norm of the infinite dimensional vector x is greater

than its projection over the set of constant functions. Let us see how this framework includes the Wirtinger-based integral inequality. In equation (2.29), we have considered the following function

$$z_1(u) = x(u) - \frac{1}{h}\Omega_0(x) - \frac{3}{h}\left(\frac{h+2u}{h}\right)\Omega_1(x), \quad \forall u \in [-h, 0].$$

where we already include the fact that the best selection for Θ is $\Theta = 3\Omega_1(x)$. Let us denote \mathcal{L}_1 the polynomial of degree 1 given by $\mathcal{L}_1(u) = \frac{h+2u}{h}$ and its normalized version denoted as $\mathcal{L}_1^*(u) = \mathcal{L}_1(u)/\sqrt{\langle \mathcal{L}_1, \mathcal{L}_1 \rangle}$ for all u in $[-h, 0]$. Simple calculations show that $\langle \mathcal{L}_1, \mathcal{L}_1 \rangle = \frac{h}{3}$, $\langle \mathcal{L}_1, x \rangle = \Omega_1(x)$, and that these two polynomials \mathcal{L}_0^* and \mathcal{L}_1^* interestingly satisfies the following equalities $\langle \mathcal{L}_0^*, \mathcal{L}_1^* \rangle = 0$, $\langle \mathcal{L}_0^*, \mathcal{L}_0^* \rangle = \langle \mathcal{L}_1^*, \mathcal{L}_1^* \rangle = 1$, which means that the functions \mathcal{L}_0^* and \mathcal{L}_1^* represent an orthonormal sequence of $\mathcal{C}([-h, 0], \mathbb{R}^n)$ associated to the inner product $\langle \cdot, \cdot \rangle$. Following the previous discussion, we can rewrite the Wirtinger-based integral inequality as follows

$$\|z_1\|_{\mathcal{C}}^2 = \left\| x - \sum_{k=0}^1 \mathcal{L}_k^* \langle \mathcal{L}_k^*, x \rangle \right\|_{\mathcal{C}}^2 = \|x\|_{\mathcal{C}}^2 - \sum_{k=0}^1 |\langle \mathcal{L}_k^*, x \rangle|^2 \geq 0,$$

which can be interpreted graphically as an inequality relating again the norm of the infinite dimensional function x to its projection over the set of polynomials of degree less than 1. This inequality can also be interpreted as the *Bessel's inequality* on Hilbert space with the *sequence of orthonormal polynomials* $\{\mathcal{L}_0^*, \mathcal{L}_1^*\}$.

This discussion drive us to find a direct solution to the problem stated at the beginning of this section. Indeed it suffices to design a sequence of orthonormal (or orthogonal) polynomials with respect to the inner product under consideration and to derive less conservative integral inequalities. More generally, the problem has become the selection an appropriate orthonormal sequence (or basis) of the Hilbert space composed by $\mathcal{C}([-h, 0], \mathbb{R}^n)$ associated to the inner product $\langle \cdot, \cdot \rangle$. Hopefully, this problem has been widely investigated in Mathematics and there exists many works on orthogonal basis on this particular Hilbert space. One may look at trigonometric functions or at polynomials functions such as Legendre's polynomials among many other functions. As induced by the notation \mathcal{L}_0 and \mathcal{L}_1 to denote the polynomials of degree of 0 and 1, we will exploit, in the next paragraph, the properties of the Legendre polynomials in order to derive efficient and less conservative integral inequalities. Latter, we will show how these inequalities can be included in the stability analysis of time-delay systems.

Basics on Legendre polynomials

In the following, a brief recall of the Legendre polynomials and their relevant properties is proposed.

Definition 2.1

The Legendre polynomials considered over the interval $[-h, 0]$ are defined by

$$\forall k \in \mathbb{N}, \quad \mathcal{L}_k(u) = (-1)^k \sum_{l=0}^k p_l^k \left(\frac{u+h}{h} \right)^l$$

with $p_l^k = (-1)^l \binom{k}{l} \binom{k+l}{l}$.

The sequence of Legendre polynomials $\{\mathcal{L}_k, k \in \mathbb{N}\}$ forms an orthogonal sequence with respect to the inner product:

$$\langle f, g \rangle = \int_{-h}^0 f(u)g(u)du, \quad \forall f, g \in \mathcal{C}. \quad (2.33)$$

These polynomials satisfy the following properties:

Property 2.1

The Legendre polynomials verify the following properties

P1 Orthogonality:

$$\forall (k, l) \in \mathbb{N}^2, \quad \int_{-h}^0 \mathcal{L}_k(u)\mathcal{L}_l(u)du = \begin{cases} 0, & k \neq l, \\ \frac{h}{2k+1}, & k = l. \end{cases} \quad (2.34)$$

P2 Boundary conditions:

$$\forall k \in \mathbb{N}, \quad \mathcal{L}_k(0) = 1, \quad \mathcal{L}_k(-h) = (-1)^k.$$

P3 Differentiation:

$$\frac{d}{du}\mathcal{L}_k(u) = \begin{cases} 0, & k = 0, \\ \sum_{i=0}^{k-1} \frac{(2i+1)}{h}(1 - (-1)^{k+i})\mathcal{L}_i(u), & k \geq 1. \end{cases}$$

Bessel-Legendre inequality

Based on the Legendre polynomials, the following lemma, presented in [297, 298] is derived.

Lemma 2.5

Let $x \in \mathcal{C}([-h, 0], \mathbb{R}^n)$ and $R \in \mathbb{S}_n^+$ and $h > 0$. Then, the inequality

$$\int_{-h}^0 x^\top(u)Rx(u)du \geq \frac{1}{h} \begin{bmatrix} \Omega_0(x) \\ \Omega_1(x) \\ \vdots \\ \Omega_N(x) \end{bmatrix}^\top \begin{bmatrix} R & & & \\ & 3R & & \\ & & \ddots & \\ & & & (2N+1)R \end{bmatrix} \begin{bmatrix} \Omega_0(x) \\ \Omega_1(x) \\ \vdots \\ \Omega_N(x) \end{bmatrix} \quad (2.35)$$

holds for all $N \in \mathbb{N}$, where $\Omega_k(x) = \int_{-h}^0 \mathcal{L}_k(u)x(u)du, k = 0, \dots, N$.

Proof: Consider a function x in $\mathcal{C}([-h, 0], \mathbb{R}^n)$, a matrix R in \mathbb{S}_n^+ and $h > 0$. Define the function z_N by

$$z_N(u) = x(u) - \sum_{k=0}^N \frac{\int_{-h}^0 \mathcal{L}_k(u)x(u)du}{\int_{-h}^0 \mathcal{L}_k^2(u)du} \mathcal{L}_k(u) = x(u) - \sum_{k=0}^N \frac{2k+1}{h} \Omega_k(x) \mathcal{L}_k(u)$$

Clearly, z_N is in $\mathcal{C}([-h, 0], \mathbb{R}^n)$ and represents the approximation error between x and its projection to the polynomial set $\{\mathcal{L}_k, k = 0, \dots, N\}$ with respect to the inner product (2.31). The integral $\int_{-h}^0 z_N^\top(u) R z_N(u) du$ exists and the orthogonal property **P1** yields

$$\begin{aligned} \int_{-h}^0 z_N^\top(u) R z_N(u) du &= \int_{-h}^0 x^\top(u) R x(u) du - 2 \sum_{k=0}^N \frac{2k+1}{h} \left(\int_{-h}^0 \mathcal{L}_k(u)x(u) du \right)^\top R \Omega_k(x) \\ &\quad + \sum_{k=0}^N \left(\frac{2k+1}{h} \right)^2 \left(\int_{-h}^0 \mathcal{L}_k^2(u) du \right) \Omega_k^\top(x) R \Omega_k(x). \end{aligned}$$

From their definition, we have $\Omega_k(x) = \int_{-h}^0 \mathcal{L}_k(u)x(u) du$ and $\left(\frac{2k+1}{h}\right)^2 \int_{-h}^0 \mathcal{L}_k^2(u) du = \frac{2k+1}{h}$, which yields

$$\int_{-h}^0 z_N^\top(u) R z_N(u) du = \int_{-h}^0 x^\top(u) R x(u) du - \sum_{k=0}^N \frac{2k+1}{h} \Omega_k^\top(x) R \Omega_k(x). \quad (2.36)$$

Finally, inequality (2.35) is obtained by noting that $\int_{-h}^0 z_N^\top(u) R z_N(u) du > 0$ since $R \succ 0$. \diamond

Remark 2.5

Considering the BL inequality with $N = 0, 1, 2$ leads to the celebrated Jensen's inequality and the Wirtinger-based inequality [296] and the auxiliary function-based inequality [244].

Remark 2.6

It is well known that the set of polynomials is dense in $\mathcal{C}([-h, 0], \mathbb{R}^n)$, Therefore the sequence of polynomial $\{\mathcal{L}_k\}_{k \geq 0}$ represents a basis of $\mathcal{C}([-h, 0], \mathbb{R}^n)$. Then, when N tends to infinity, the Bessel-Legendre inequality tends to an equality and

$$\int_{-h}^0 x^\top(u) R x(u) du = \frac{1}{h} \sum_{k=0}^{\infty} (2k+1) \Omega_k^\top(x) R \Omega_k(x).$$

Optimality of the Bessel-Legendre inequality

In the previous lemma, we have used the Legendre polynomials because of their orthogonal properties with respect to the integral inner product. This choice of polynomials has shown some interests since the results inequality has a diagonal structure.

The selection of the Legendre polynomials is interesting not only for this diagonal structure. From the approximation theory, the polynomial $\sum_{k=0}^N \frac{2k+1}{h} \Omega_k(x) \mathcal{L}_k(u)$ is the best polynomial approximation of degree N of the function x in the sense of the inner product, since it minimizes the distance between x with the set of polynomials of degree less than or equal N . In other words, the minimization

$$\min_{P \in \mathbb{R}_N^n[u]} \int_{-h}^0 (x(u) - P(u))^T R (x(u) - P(u)) du$$

where $\mathbb{R}_N^n[u]$ is the set of polynomials of \mathbb{R}^n of degree less than N , is obtained with

$$P(u) = \sum_{k=0}^N \frac{\langle x, \mathcal{L}_k \rangle}{\langle \mathcal{L}_k, \mathcal{L}_k \rangle} \mathcal{L}_k(u) = \sum_{k=0}^N \frac{2k+1}{h} \Omega_k(x) \mathcal{L}_k(u).$$

where we used a light abuse of notation. Therefore, the Bessel-Legendre inequality provided in Lemma 2.5 is optimal. To see this optimality, let us consider the canonical basis of the polynomials. Following the same procedure as in the previous lemma, the following lemma is derived

Lemma 2.6

Let $x \in \mathcal{C}([-h, 0], \mathbb{R}^n)$ and $R \in \mathbb{S}_n^+$ and $h > 0$. Consider a sequence of polynomials $\{p_k\}_{k=0, \dots, N}$ representing a basis of the set of polynomials of degree less than N and a sequence of real numbers $\{\beta_k\}_{k=0, \dots, N}$.

Then, the inequality

$$\int_{-h}^0 x^\top(u) R x(u) du \geq \begin{bmatrix} \Theta_0(x) \\ \Theta_1(x) \\ \vdots \\ \Theta_N(x) \end{bmatrix}^\top \begin{bmatrix} \alpha_{00} R & \alpha_{01} R & \dots & \alpha_{0N} R \\ \alpha_{01} R & \alpha_{11} R & \dots & \vdots \\ \vdots & \vdots & \ddots & \vdots \\ \alpha_{0N} R & \dots & \dots & \alpha_{NN} R \end{bmatrix} \begin{bmatrix} \Theta_0(x) \\ \Theta_1(x) \\ \vdots \\ \Theta_N(x) \end{bmatrix} \quad (2.37)$$

holds for all $N \in \mathbb{N}$, where, for $i, k = 0, \dots, N$

$$\alpha_{ik} = \begin{cases} -\beta_k \beta_i \int_{-h}^0 p_k(u) p_i(u) du, & \text{if } i \neq k, \\ 2\beta_k - \beta_k^2 \int_{-h}^0 p_k^2(u) du, & \text{if } i = k, \end{cases} \quad \text{and } \Theta_k(x) = \int_{-h}^0 p_k(u) x(u) du.$$

Proof: The proof is similar to the one of Lemma 2.5. Consider a function x in $\mathcal{C}([-h, 0], \mathbb{R}^n)$, a matrix R in \mathbb{S}_n^+ and $h > 0$. Define the function z_N by

$$y_N(u) = x(u) - \sum_{k=0}^N \beta_k p_k(u) \int_{-h}^0 p_k(s) x(s) ds = x(u) - \sum_{k=0}^N \beta_k p_k(u) \Theta_k(x).$$

The integral $\int_{-h}^0 y_N^\top(u) R y_N(u) du$ exists and we have

$$\begin{aligned} \int_{-h}^0 y_N^\top(u) R y_N(u) du &= \int_{-h}^0 x^\top(u) R x(u) du - 2 \sum_{k=0}^N \beta_k \left(\int_{-h}^0 p_k(u) x(u) du \right)^\top R \Theta_k(x) \\ &\quad + \sum_{k=0}^N \sum_{i=0}^N \beta_k \beta_i \int_{-h}^0 p_k(s) p_i(s) ds \Theta_k^\top(x) R \Theta_i(x). \end{aligned}$$

Noting that $\Theta_k = \int_{-h}^0 p_k(u)x(u)du$, it yields

$$\begin{aligned} \int_{-h}^0 y_N^\top(u)Ry_N(u)du &= \int_{-h}^0 x^\top(u)Rx(u)du - \sum_{k=0}^N (2\beta_k - \beta_k^2)\Theta_k^\top(x)R\Theta_k(x) \\ &\quad + 2 \sum_{k=1}^N \sum_{i=k+1}^N \beta_k\beta_i \int_{-h}^0 p_k(s)p_i(s)ds \Theta_k^\top(x)R\Theta_i(x). \end{aligned} \quad (2.38)$$

Finally, inequality (2.37) is obtained by noting that $\int_{-h}^0 y_N^\top(u)Ry_N(u)du > 0$ since $R \succ 0$. \diamond

This lemma presents another integral inequality, which can be used to obtain a new stability condition. However, on the one hand, the matrix $[\alpha_{ik}]_{i,k=0,\dots,N}$ is not necessarily positive definite. This means that this new inequality may be really conservative. On a second hand, following the discussion above, the polynomial $\sum_{k=0}^N \frac{2k+1}{h}\Omega_k\mathcal{L}_k(u)$ minimizes the distance between the infinite dimensional function x and the set of polynomials of degree less than N . This means that, the inequality

$$\int_{-h}^0 y_N^\top(u)Ry_N(u)du \geq \int_{-h}^0 z_N^\top(u)Rz_N(u)du$$

holds and the equality occurs only if $y_N = z_N$. Finally, the two expressions provided in (2.36) and (2.38) implies the following inequality

$$\begin{bmatrix} \Theta_0 \\ \Theta_1 \\ \vdots \\ \Theta_N \end{bmatrix}^\top \begin{bmatrix} \alpha_{00}R & \alpha_{01}R & \dots & \alpha_{0N}R \\ \alpha_{01}R & \alpha_{11}R & \dots & \vdots \\ \vdots & \vdots & \ddots & \vdots \\ \alpha_{0N}R & \dots & \dots & \alpha_{NN}R \end{bmatrix} \begin{bmatrix} \Theta_0 \\ \Theta_1 \\ \vdots \\ \Theta_N \end{bmatrix} \leq \begin{bmatrix} \Omega_0 \\ \Omega_1 \\ \vdots \\ \Omega_N \end{bmatrix}^\top \begin{bmatrix} R & & & \\ & 3R & & \\ & & \ddots & \\ & & & (2N+1)R \end{bmatrix} \begin{bmatrix} \Omega_0 \\ \Omega_1 \\ \vdots \\ \Omega_N \end{bmatrix},$$

where the argument “(x)” has been omitted for the sake of simplicity.

This demonstrates that the Bessel-Legendre inequality is the less conservative inequality that can be derived, of course, when one considers the projection of polynomials sets.

Remark 2.7

This results can also be related to the “sum of squares” framework that has been developed and employed in similar contexts of automatic control in [151, 245, 253, 238, 237, 334]. In this framework, the objectives often relies on the optimization of the coefficients β_k , $k = 0, \dots, N$, that delivers the best inequality. Lemma 2.5 only says that the optimal integral inequality for this inner product is related to the Legendre polynomials.

Further comments on the approximation of infinite dimensional state function.

Another interesting comments on this framework is related to the interpretation of the function z_N which is recalled for the sake of simplicity

$$z_N(u) = x(u) - \sum_{k=0}^N \frac{2k+1}{h}\Omega_k(x)\mathcal{L}_k(u).$$

As we mentioned earlier in this chapter, this function can be interpreted that error of approximation of the infinite dimensional function x by a finite dimensional polynomial function given by $\sum_{k=0}^N \frac{2k+1}{h} \Omega_k(x) \mathcal{L}_k(u)$. In other words, we have

$$x(u) \approx \sum_{k=0}^N \frac{2k+1}{h} \Omega_k(x) \mathcal{L}_k(u) = \frac{1}{h} [\mathcal{L}_0(u)I \quad \mathcal{L}_1(u)I \quad \dots \quad \mathcal{L}_N(u)] \begin{bmatrix} \Omega_0(x) \\ \Omega_1(x) \\ \vdots \\ \Omega_N(x) \end{bmatrix}.$$

In general, the series $\sum_{k=0}^N \frac{2k+1}{h} \Omega_k(x) \mathcal{L}_k(u)$ does not converges point to point to $x(u)$. It only converge to x in the sense of the norm associated to the inner product. However, if the function x is infinitely differentiable over the interval $(-h, 0)$, then we have

$$x(u) = \sum_{k=0}^{\infty} \frac{2k+1}{h} \Omega_k(x) \mathcal{L}_k(u), \quad \forall u \in (-h, 0).$$

Coming back to the Lyapunov analysis and the stability analysis of time-delay systems, the convergence of the projections $\Omega_k(x_t)$, for all $k \geq 0$ and where x_t is the state of a time-delay system, to zero implies the convergence of x to zero as well. This will be taken into account in the Lyapunov analysis developed in the next section. Moreover, we will show that if we can prove the converge to zero of $\Omega_k(x_t)$, for all $k = 0, \dots, N$, then the remainder of the projections, $\Omega_k(x_t)$, for all $k \geq N+1$, also converge to zero.

To conclude, the Bessel-Legendre inequality introduces additional information on the delay system brought by the projection vectors $\Omega_k(x_t)$, for $k = 0, \dots, N$, where x_t is the state of a time-delay system. The objective, when including these terms in a Lyapunov analysis finally consists in taking into account more and more information on the system state x_t .

A suitable corollary for the stability analysis of time-delay systems

As discussed earlier, the problem is often to derive a lower bound of $\int_{-h}^0 \dot{x}^\top(u) R \dot{x}(u) du$. The next corollary addresses this particular problem.

Corollary 2.1

Let x be such that $\dot{x} \in \mathcal{C}$, $R \in \mathbb{S}_n^+$ and $h > 0$. Then, the integral inequality

$$\int_{-h}^0 \dot{x}^\top(u) R \dot{x}(u) du \geq \frac{1}{h} \xi_N^\top \left[\sum_{k=0}^N (2k+1) \Gamma_N(k)^\top R \Gamma_N(k) \right] \xi_N, \quad (2.39)$$

holds for all integer $N \in \mathbb{N}$ where

$$\xi_N = \begin{cases} [x^\top(0) \ x^\top(-h)]^\top, & \text{if } N = 0, \\ \left[x^\top(0) \ x^\top(-h) \ \frac{1}{h} \Omega_0^\top(x) \ \dots \ \frac{1}{h} \Omega_{N-1}^\top(x) \right]^\top, & \text{if } N > 0, \end{cases}$$

$$\Gamma_N(k) = \begin{cases} \begin{bmatrix} I & -I \\ I & (-1)^{k+1} I \end{bmatrix}, & \text{if } N = 0, \\ \begin{bmatrix} I & -I & & \\ & I & (-1)^{k+1} I & \\ & & \gamma_{Nk}^0 I & \dots \\ & & & \gamma_{Nk}^{N-1} I \end{bmatrix}, & \text{if } N > 0. \end{cases}$$

$$\gamma_{Nk}^i = \begin{cases} -(2i+1)(1 - (-1)^{k+i}), & \text{if } i \leq k, \\ 0, & \text{if } i > k. \end{cases}$$

and where Ω_k is defined in Lemma 2.5.

Proof: Applying Lemma 2.5 to the order N leads to

$$\int_{-h}^0 \dot{x}^\top(u) R \dot{x}(u) du \geq \frac{1}{h} \sum_{k=0}^N (2k+1) \Omega_k^\top(\dot{x}) R \Omega_k(\dot{x}), \quad (2.40)$$

where we recall that $\Omega_k(\dot{x}) = \int_{-h}^0 \mathcal{L}_k(u) \dot{x}(u) du$, for all $k = 0, 1, \dots, N$. An integration by parts ensures that, for all $k \geq 0$

$$\Omega_k(\dot{x}) = \mathcal{L}_k(0)x(0) - \mathcal{L}_k(-h)x(-h) - \int_{-h}^0 \left(\frac{d}{du} \mathcal{L}_k(u) \right) x(u) du.$$

Thanks to properties **P2** and **P3** of the Legendre polynomials, the following expression is derived

$$\Omega_k(\dot{x}) = x(0) - (-1)^k x(-h) + \sum_{i=0}^{k-1} \frac{\gamma_{Nk}^i}{h} \Omega_i(x) = \Gamma_N(k) \xi_N. \quad (2.41)$$

Replacing $\Omega_k(\dot{x})$ by its expression using $\Omega_i(x)$, $i = 0, \dots, k$ and the matrices $\Gamma_N(k)$, $k = 1, \dots, N$ leads to (2.39) and concludes the proof. \diamond

2.4 Application to linear systems with a constant delay

2.4.1 Stability theorem

In this paragraph, a first stability result for time-delay systems is provided by the use of the Bessel-Legendre inequality developed in the previous section. We will study the stability of the following

linear system subject to a constant delay

$$\begin{cases} \dot{x}(t) = Ax(t) + A_d x(t-h), & \forall t \geq 0, \\ x(t) = \phi(t), & \forall t \in [-h_2, 0], \end{cases} \quad (2.42)$$

where $x(t) \in \mathbb{R}^n$ is the state vector, ϕ is the initial conditions and A and A_d , are constant matrices. The following stability theorem, presented in [298], is provided by the use of Corollary 2.1 with an arbitrary N .

Theorem 2.3

For a given integer N and a constant delay h , assume that there exist a matrix $P_N \in \mathbb{S}_{(N+1)n}$ and two matrices $S, R \in \mathbb{S}_n^+$ such that the LMI

$$\begin{aligned} \Theta_N(h) &= \begin{cases} P_N \succ 0, & \text{if } N = 0, \\ P_N + \frac{1}{h} \begin{bmatrix} 0 & & & \\ & S & & \\ & & \ddots & \\ & & & (2N-1)S \end{bmatrix} \succ 0, & \text{if } N > 0, \end{cases} \\ \Phi_N(h) &= \Phi_{N0}(h) - \begin{bmatrix} \Gamma_N(0) \\ \vdots \\ \Gamma_N(N) \end{bmatrix}^\top \begin{bmatrix} R & & & \\ & 3R & & \\ & & \ddots & \\ & & & (2N+1)R \end{bmatrix} \begin{bmatrix} \Gamma_N(0) \\ \vdots \\ \Gamma_N(N) \end{bmatrix} \prec 0, \end{aligned} \quad (2.43)$$

hold, where $\Gamma_N(k)$, for all $k = 0, \dots, N$, are defined in Corollary 2.1 and

$$\begin{aligned} \Phi_{N0}(h) &= \text{He}(G_N^\top(h)PH_N) + \tilde{S}_N + h^2 F_N^\top R F_N, \\ \tilde{S}_N &= \text{diag}\{S, -S, 0_{nN}\}, \\ F_N &= \begin{bmatrix} A & A_d & 0_{n,nN} \end{bmatrix}, \\ G_N(h) &= \begin{bmatrix} I & 0_n & 0_{n,nN} \\ 0_{nN,n} & 0_{nN,n} & hI_{nN} \end{bmatrix}, \\ H_N &= \begin{bmatrix} F_N^\top & \Gamma_N^\top(0) & \Gamma_N^\top(1) & \dots & \Gamma_N^\top(N-1) \end{bmatrix}^\top. \end{aligned}$$

Then the time-delay system (2.42) is asymptotically stable for the constant delay h .

Proof: For the sake of simplicity, the proof of this theorem is not presented. It can however be found in [298]. We only mention that the proof of Theorem 2.3 relies on the Lyapunov-Krasovskii functional

$$V_N(x_t, \dot{x}_t) = \tilde{x}_N^\top(t)P_N\tilde{x}_N(t) + \int_{t-h}^t x^\top(s)Sx(s)ds + h \int_{t-h}^t \int_\theta^\top \dot{x}^\top(s)R\dot{x}(s)dsd\theta, \quad (2.44)$$

where, guided by the B-L inequality (2.39) and the signals involved, we have considered the augmented state vector $\tilde{x}_N(t)$ given by:

$$\tilde{x}_N(t) = \begin{bmatrix} x_t(0) \\ \int_{-h}^0 \mathcal{L}_0(s)x_t(s)ds \\ \vdots \\ \int_{-h}^0 \mathcal{L}_{N-1}(s)x_t(s)ds \end{bmatrix} = \begin{bmatrix} x_t(0) \\ \Omega_0(x_t) \\ \vdots \\ \Omega_{N-1}(x_t) \end{bmatrix},$$

if $N \geq 1$ and $\tilde{x}_0(t) = x_t(0)$, if $N = 0$. The augmented vector \tilde{x}_N is composed by the instantaneous state $x_t(0)$ and the projections of the state function x_t to the N first Legendre polynomials. \diamond

Remark 2.8

Taking $N = 0$ in Theorem 2.3 allows retrieving one of the most classical delay-dependent stability conditions based on Jensen's inequality and LMI [130]. Additionally, choosing $N = 1$ leads to the stability conditions from [296].

Remark 2.9

An interpretation of the BL inequality and the associated stability analysis is provided in the context of robust analysis in [127, 128]. In this second paper, we have notably showed that the same LMI conditions presented in Theorem 2.3 imply

$$\det(sI - A - A_d e^{-hs}) \neq 0, \quad \forall s \in \mathbb{C}, \text{ s.t. } \operatorname{Re}(s) \geq 0,$$

which brings the link between this Lyapunov analysis and the frequency analysis of the time-delay system.

2.4.2 Remark on the choice of the Lyapunov-Krasovskii functional

A comment on the Lyapunov-Krasovskii functional, V_N , and its relation with the class of functionals studied in [134, 248] is highlighted here. Indeed by considering the functional (2.44) and by defining the polynomial matrix $D(s) = \operatorname{diag}(0_n, \mathcal{L}_0(s)I, \mathcal{L}_1(s)I, \dots, \mathcal{L}_N(s)I)$ and the matrices

$$\begin{aligned} \tilde{P} &= \begin{bmatrix} I \\ 0_{nN,n} \end{bmatrix}^\top P_N \begin{bmatrix} I \\ 0_{nN,n} \end{bmatrix}, \quad S(s) = S, \\ \mathcal{Q}(s) &= \begin{bmatrix} I \\ 0_{nN,n} \end{bmatrix}^\top P_N D(s), \quad \mathcal{T}(s, \xi) = D^\top(s) P_N D(\xi). \end{aligned}$$

Therefore, the functional V_N can be rewritten as

$$\begin{aligned} V_N(x_t, \dot{x}_t) &= x^\top(t) \tilde{P} x(t) + 2x^\top(t) \int_{-h}^0 \mathcal{Q}(s) x_t(s) ds + \int_{-h}^0 \int_{-h}^0 x_t^\top(s) \mathcal{T}(s, \xi) x_t(\xi) ds d\xi \\ &\quad + \int_{-h}^0 x_t^\top(s) S(s) x_t(s) ds + h \int_{-h}^0 \int_{\theta}^0 \dot{x}_t^\top(s) R \dot{x}_t(s) ds d\theta. \end{aligned} \tag{2.45}$$

The three first terms of V_N are similar to the ones presented in equation (2.17) and employed in [248] and in [134]. In [248], the degree of freedom comes from the degree of the polynomial matrices $Q(s)$, $S(s)$ and $R(s, \xi)$, denoted as D_p . In [134], the degree of the polynomial is always 1 but the degree of freedom comes from the degree of discretization, denoted latter on as D_d .

A first difference with respect to these two approaches is that in our setup, the polynomial matrix $S(s)$ is constant. The consequence is that our method requires less parameters to define the functional when increasing D_p or D_d . Another difference relies on the last integral quadratic term of V_N which depends on \dot{x}_t . Finally, the previous theorem does not need to enter into the sum of squares

framework which generally requires the use of additional decision relaxation variables when testing the stability conditions.

Remark 2.10

Note that in [297] or in [302], similar theorems were deployed based on the complete representation of Lyapunov-Krasovskii functionals, as employed in, for instance, [248] and [134]. It simply consists in a light modification in 2.45 where the last integral term depends on x_t instead of \dot{x}_t .

2.4.3 Hierarchy of LMI stability conditions

This section is devoted to proving that the previous stability conditions form a hierarchy of LMI conditions. This is formulated in the next theorem based on the stability conditions of Theorem 2.3.

Theorem 2.4

For any time-delay system (2.42), define the set \mathcal{H}_N by

$$\mathcal{H}_N := \left\{ h \in \mathbb{R}^+ \text{ s.t. } \Theta_N(h) \succ 0, \Phi_N(h) \prec 0, P_N, S(N) \succ 0, R(N) \succ 0 \right\}$$

Then, it holds

$$\mathcal{H}_N \subset \mathcal{H}_{N+1}, \quad \forall N \geq 0.$$

Proof : The proof is omitted for the sake of simplicity. To get the flavor of it, it suffices to assume that if there exist symmetric matrices $P_N, S(N) \succ 0$ and $R(N) \succ 0$ such that $\Theta_N(h) \succ 0$ and $\Phi_N(h) \prec 0$, then considering

$$P_{N+1} = \begin{bmatrix} P_N & 0 \\ 0 & 0 \end{bmatrix}, \quad \begin{cases} S(N+1) = S(N) = S, \\ R(N+1) = R(N) = R, \end{cases}$$

the structural properties of the LMI allows us to conclude the proof. \diamond

Theorem 2.4 proves that, the stability conditions provided in Theorem 2.3 at the order $N + 1$ delivers, at least, the same result the same condition taken at the order N . Since Theorem 2.3 only provides sufficient stability condition, the set \mathcal{H}_N , for a given $N \in \mathbb{N}$ represents an inner approximation of the stability pockets. Moreover, the proof also show that

$$\mathcal{H}_{N+1} \Big|_{P_{N+1} = \begin{bmatrix} P_N & 0 \\ 0 & 0 \end{bmatrix}} = \mathcal{H}_N,$$

where the set on the left-hand-side stands for the restriction of \mathcal{H}_{N+1} to matrices P_{N+1} of the corresponding form. A brief recursive reasoning allows us to obtain that

$$\mathcal{H}_{N+1} \Big|_{P_{N+1} = \begin{bmatrix} P_0 & 0 \\ 0 & 0 \end{bmatrix}} = \mathcal{H}_0, \quad P_0 \in \mathbb{S}^n$$

This equality of sets can be interpreted as follows. If one uses the Bessel-Legendre (or the Wirtinger-based) inequality, without augmenting the size of the matrix P_N , or, again, without enriching the functional by the projection Ω_k , with $k \leq N - 1$, then the result is strictly equivalent to the

Theorems	h_{max}	number of var.	Methods
Theoretical bound	6.1725	-	Frequency approach
[130, 144]	4.472	$1.5n^2 + 1.5n$	L-K functional + Jensen
[326]	5.02	$18n^2 + 18n$	L-K functional + Jensen
[325]	5.30	$8.5n^2 + 3.5n$	L-K functional + Jensen
[294]	5.901	$3n^2 + 2n$	L-K functional + Wirtinger-based
[170]	6.1107	$1.5n^2 + 9n + 9$	IQC + filter
[15]	5.120	$7n^2 + 4n$	QS + filter
[141], $D_d = 2$	5.71	$4n^2 + 2n$	L-K functional + Jensen + Partition
[141], $D_d = 3$	5.96	$6.5n^2 + 2.5n$	L-K functional + Jensen + Partition
[141], $D_d = 4$	6.05	$10n^2 + 3n$	L-K functional + Jensen + Partition
[134], $D_d = 1$	6.053	$7.5n^2 + 3.5n$	L-K functional + Discretization
[134], $D_d = 2$	6.165	$10.5n^2 + 4.5n$	L-K functional + Discretization
[134], $D_d = 3$	6.171	$14.5n^2 + 4.5n$	L-K functional + Discretization
[248], $D_p = 1$	5.19	$7n^2 + 3n$	L-K functional + SOS
[248], $D_p = 2$	5.90	$12.5n^2 + 4.5n$	L-K functional + SOS
[248], $D_p = 3$	6.10	$21n^2 + 6n$	L-K functional + SOS
Th.2.3, $N = 0$	4.472	$1.5n^2 + 1.5n$	L-K functional + Bessel
Th.2.3, $N = 1$	6.059	$3n^2 + 2n$	L-K functional + Bessel
Th.2.3, $N = 2$	6.168	$5.5n^2 + 2.5n$	L-K functional + Bessel
Th.2.3, $N = 3$	6.1725	$9n^2 + 3n$	L-K functional + Bessel

Table 2.1: Results for Example (2.46) for constant delay h . The degree of discretization D_d and the degree of the polynomial D_p are defined in Subsection 2.4.2.

one obtained using the Jensen's inequality (i.e. $N = 0$). Therefore the augmentation of the size of the matrix P_N is crucial to derive less conservative numerical results.

Finally, Theorem 2.3 provides a hierarchy of LMI conditions for the analysis of time-delay systems. This means that increasing N potentially helps to reduce the conservatism of the conditions, and potentially to detect greater and greater stability regions. Nevertheless, Theorem 2.3 does not prove that the conditions of Theorem 2.3 will converge to the analytical bounds of the delay. In other words, Theorem 2.3 does not answer to the question

“If the system is asymptotically stable for a given delay h , does there exist an integer N such that the LMI conditions provided in Theorem 2.3 holds?”

As it will be exposed in the next section, where numerical examples are treated, the conditions of Theorem 2.3 are very efficient from the numerical point of view and also its complexity is very competitive with respect to other stability conditions from the literature. Through these examples, we have always been able to obtain an encouraging result, even for non trivial systems.

We have not been able to answer to this question yet. However, we strongly believe that the properties of the Legendre polynomials together with the existence of a complete Lyapunov-Krasovskii functionals will lead the way to a positive answer.

2.5 Numerical applications and extensions

2.5.1 Linear systems with a single discrete delay

The purpose of the following section is to illustrate on academic and non trivial examples how the inequalities given in Section 3 lead to a relevant reduction of conservatism in the stability condition.

Example 1:

Consider the same linear time-delay system (2.42) with the matrices

$$A = \begin{bmatrix} -2 & 0 \\ 0 & -0.9 \end{bmatrix}, \quad A_d = \begin{bmatrix} -1 & 0 \\ -1 & -1 \end{bmatrix}. \quad (2.46)$$

This system is a well-known delay dependent stable system, that is the delay free system is stable and the maximum allowable delay $h_{\max} = 6.1725$ can be easily computed by delay sweeping techniques. The results are reported in Table 2.1. Many recent papers give the same result since they are intrinsically based on the same Lyapunov-Krasovskii functional and use the same bounding cross terms technique i.e. Jensen inequality. Some papers [326],[325] which use an augmented Lyapunov, based on the addition on a triple Integral term on the Lyapunov-Krasovskii functional can go further but with a numerically increasing burden, compared to our proposal. The partitioning approach proposed by [141] based on the discrete delay decomposition gives an upper bound which tends to the analytical value even if the numerical complexity remains important. The robust approach [170] gives a very good upper-bound with a similar computational complexity than our present result. The discretized Lyapunov-Krasovskii functional proposed by [134] as well as the sum of square optimization scheme developed by Peet et al [248] gives a delay upper bound very closed to the maximum allowable delay with an increasing numerical complexity.

Example 2:

This example is provided to illustrate Theorem 2.4. Note that this system has not been studied in the literature of time-delay system using the Lyapunov-Krasovskii Theorem and LMI conditions. It is extracted from the dynamics of machining chatter [359, 318] and is given by

$$\begin{cases} \dot{x}(t) = A_0x(t) + Bu(t), \\ y(t) = Cx(t), \end{cases}$$

with

$$A_0 = \begin{bmatrix} 0 & 0 & 1 & 0 \\ 0 & 0 & 0 & 1 \\ -10 & 10 & 0 & 0 \\ 5 & -15 & 0 & -0.25 \end{bmatrix}, \quad B = \begin{bmatrix} 0 \\ 0 \\ 1 \\ 0 \end{bmatrix}, \quad C = \begin{bmatrix} 1 \\ 0 \\ 0 \\ 0 \end{bmatrix}^T. \quad (2.47)$$

A delayed static output feedback controller is proposed:

$$u(t) = -K(y(t) - y(t - h)),$$

where K is the gain of the controller and h is an unknown constant delay. The resulting dynamics is thus modeled by a time-delay system:

$$\dot{x}(t) = A_0x(t) + A_dx(t - h),$$

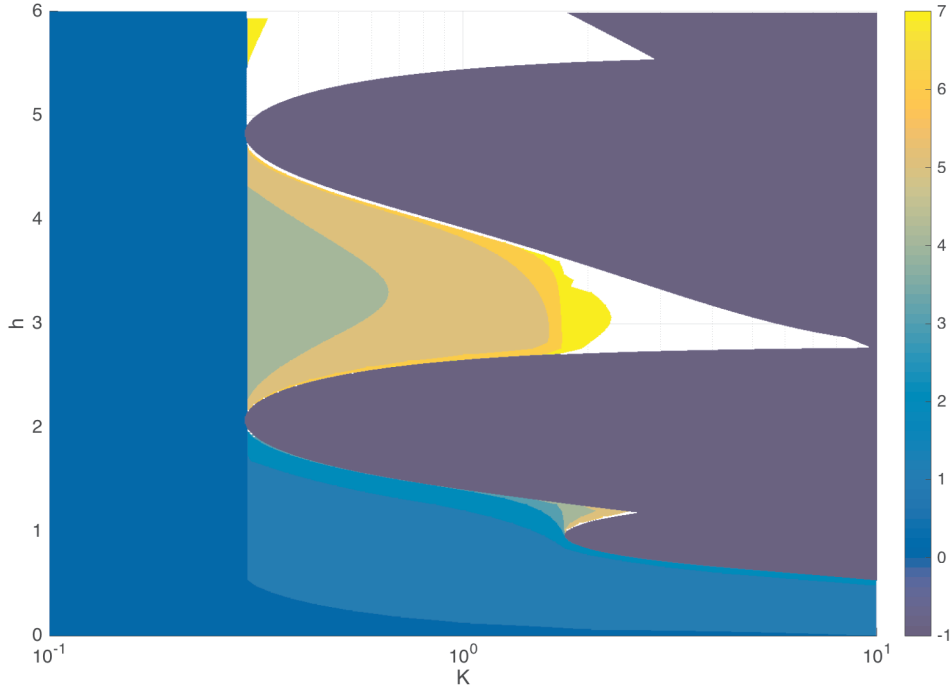

Figure 2.4: Stability region in the plan (K, h) , obtained using Theorem 2.3 for $N = 0, \dots, 7$. The instable area, computed through a frequency analysis corresponds to the dark area, which is depicted with the color associated to $N = -1$

with $A = A_0 - BKC$ and $A_d = BKC$.

The results are summarized in Figure 2.4 which shows the stability regions in the (K, h) plane. The blue region represents the instability region which have been calculated using a griding over K along with the `allmargin` function of the Control Toolbox of Matlab©. Then, Theorem 2.3 provides inner approximations of the stability colored regions. The region corresponding to $N = 0$ perfectly detects the independent of the delay stability region (for $K \leq 0.3$) as well as a first delay dependent stability pocket. It corresponds to the maximal allowable delay when Jensen's Lemma is used when establishing the stability criterion. Taking $N = 1$ allows retrieving the same results as in [296] which uses Wirtinger's Lemma. Clearly, increasing N ($N = 0, 1, \dots, 7$) allows reducing the pessimism and discovering new stability pockets. This figure illustrates the implication of Theorem 2.4 on the inclusions $\mathcal{H}_0 \subset \mathcal{H}_1 \subset \dots \subset \mathcal{H}_7$. Another important remark is that increasing N can improve significantly the inner approximations of the stability region. For instance, $\mathcal{H}_4 \setminus \mathcal{H}_3$, $\mathcal{H}_5 \setminus \mathcal{H}_4$ or even $\mathcal{H}_7 \setminus \mathcal{H}_6$ are surprisingly large sets.

Example 3:

Consider the system with pointwise delay taken from [94] given by

$$\ddot{x}(t) + \begin{bmatrix} 0 & 1 \\ -1 & 0 \end{bmatrix} \dot{x}(t-h) + \begin{bmatrix} 4 & 0 \\ 0 & 16 \end{bmatrix} x(t) = 0$$

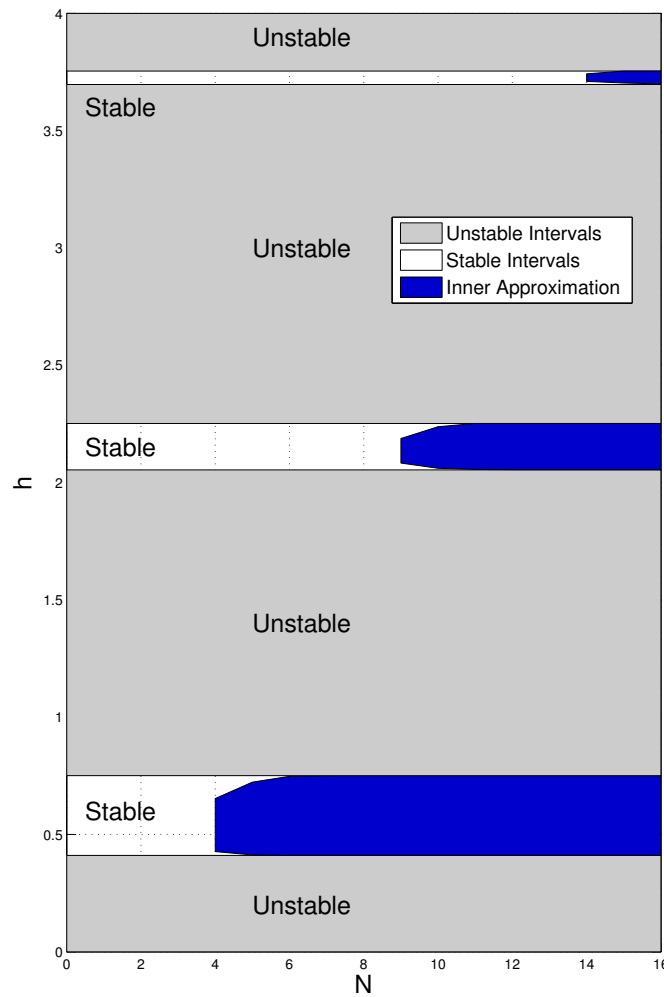

Figure 2.5: Stability region in the plan (N, h) , obtained using Theorem 2.3 (and Remark 2.10) for Example 4.

The analysis provided in [94] based on a frequency method ensures that this systems has exactly three stable delay intervals $[0.4108, 0.7509]$, $[2.054, 2.252]$ and $[3.697, 3.754]$. Figure 2.5 shows the inner approximations obtained with similar conditions as the ones presented in Theorem 2.3 (according to the modifications explained in Remark 2.10) for several values of N . The first interval is detected at $N = 4$ and a good¹ estimation of the first stable interval is first obtained at $N = 7$. First values of the delay h in the second stable interval are detected with $N = 9$ and a good estimation of the whole interval is obtained at $N = 11$. Delay values in the third and last stable interval, which is more difficult to detect are found with $N = 14$ and a good estimation of the interval is provided with $N = 16$.

This example shows the efficiency of our method to detect stability intervals even for systems with discrete delay and with dimension that are not small unlike usual examples. In addition, The example and Figure 2.5 also illustrate Theorem 2.4. Indeed, Figure 2.5 shows that the stability regions become larger when N increases. The stability conditions are able to assess stability of the system for all the

¹with a precision of 10^{-4}

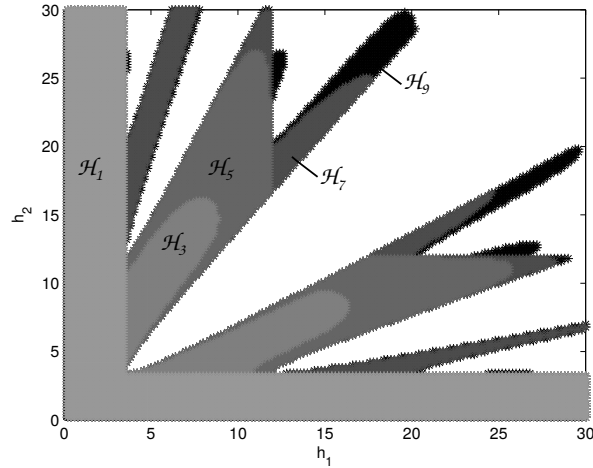

Figure 2.6: Stability regions in the plan (h_1, h_2) obtained in [28] for Example 4.

values of the delay which belongs to the stable intervals.

2.5.2 Linear systems with multiple discrete delays

Through this example we aim at showing that the proposed approach can address the case of linear systems with multiple delays. The associated analysis is related to the PhD of M. Safi and the associated publications [28, 266, 267] is omitted here for simplicity. However, and to be short, the method consists in extending the Lyapunov-Krasoskii functionals to cope with the several delays using a coupled PDE-ODE systems and a homogeneous delay representation.

Example 4:

Let us consider one of the most classical example of systems with multiple delays, which was studied in [318], using a frequency domain analysis. This system is governed by

$$\dot{x}(t) = -1.3x(t) - x(t - h_1) - 0.5x(t - h_2)$$

The conditions proposed in Theorem 2.3 can be extended to the case of multiple delays as proposed in [28] addresses also the stability of systems that may be unstable for a very high speed of transport as it is illustrated with this example. For this example, Fig. 2.6 gives the stability regions for different values of h_1 and h_2 . We can remark that increasing N allows us to broaden the stability region of the coupled system. This example prove also Theorem 2.4 where $\mathcal{H}_1 \subset \mathcal{H}_3 \subset \dots \subset \mathcal{H}_9$ and if we have stability for $N = 1$ with a given h_1 and h_2 , we ensure stability for the same pair of transport speed with $N > 1$.

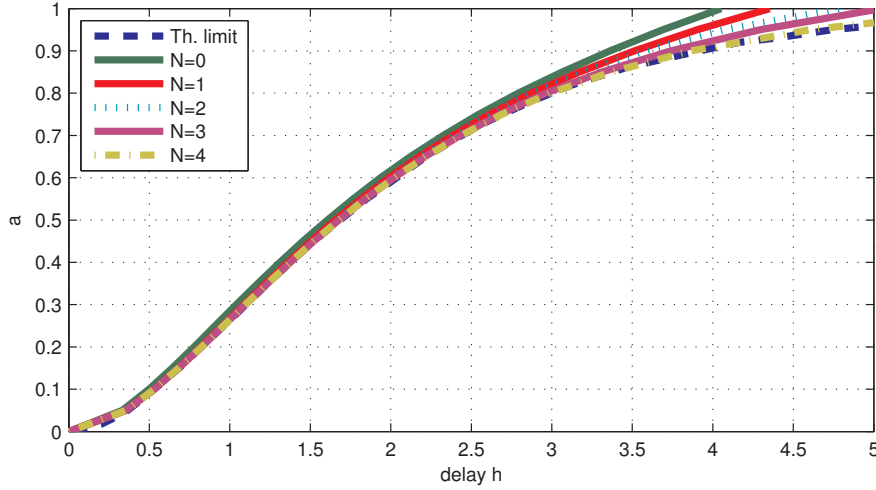

Figure 2.7: Stability regions in the plan (a, h) for system (2.49), obtained using Theorem 2.3 for several values of N .

2.5.3 Linear systems with a distributed delay

In [302], we have extended the analysis, which have led to Theorem 2.3 to the class of distributed delay systems of the form

$$\begin{cases} \dot{x}(t) = Ax(t) + A_d \int_{-h}^0 f(\theta)x(t+\theta)d\theta, \quad \forall t \geq 0, \\ x(t) = \phi(t), \quad \forall t \in [-h, 0], \end{cases} \quad (2.48)$$

where $x(t) \in \mathbb{R}^n$ is the state vector, ϕ is a continuous function, representing the initial conditions, A and A_d are constant matrices and f denotes a known continuous function of $L_2([-h, 0] \rightarrow \mathbb{R})$ and represents the kernel of the distributed delay. The delay h is assumed to be constant. This class of systems can be seen as a particular case of (2.6), where the most general case of kernel matrix $A_D(\theta)$ is replaced by $f(\theta)A_d$. The goal was here to provide a generic analysis which is able to assess stability of system (2.48) for any continuous scalar kernel f and to derive sufficient stability conditions based, again on the properties of the Legendre polynomials.

For the sake of simplicity, the detailed analysis will not be presented in this manuscript but the reader may refer to [302] to have a better understanding of how the Bessel-Legendre inequality is applied to this problem.

Example 5:

Consider the distributed delay system

$$\dot{x}(t) = -ax(t) - \int_{-h}^0 \gamma(k, \alpha, -\theta)x(t+\theta)d\theta, \quad (2.49)$$

where a is a positive scalar and γ the scalar kernel function of the truncated Gamma Distribution defined by

$$\gamma(k, \alpha, \theta) = \frac{\theta^{k-1}e^{-\theta/\alpha}}{(k-1)!\alpha^k}, \quad \forall (k, \alpha, \theta) \in \mathbb{N} \times (0, \infty) \times [-h, 0],$$

and such that $\int_{-\infty}^0 \gamma(k, \alpha, \theta) d\theta = 1$. From the theoretical point of view, Gamma distributions are often considered over the interval $(-\infty, 0]$. Since the kernel γ contains an exponential term, it is reasonable to consider the truncated interval $[-h, 0]$ because the main contribution to the distributed term relies on this first interval. Figure 2.7 represents the stability regions obtained by solving Theorem 2.3 for several values of N when $\alpha = 1$ and $k = 1$. The dashed black line represents the theoretical limits resulting from the eigenvalue analysis issued from [32]. Figure 2.7 shows that from small values of a in $(0, 0.6]$, Theorem 2.3 with $N = 0, 1$ delivers good estimations of the stability regions. However for larger values of a , Figure 2.7 shows that Theorem 2.3 with $N = 0, 1$ is conservatism since the stability regions do not match with the theoretical limits drawn by the dashed blue line. However, increasing N in Theorem 2.3 allows reducing this conservatism and one can see that for $N = 4$, the estimation of the stability region is very close to the theoretical region. This example illustrates the potential of our hierarchical approach to reduce the conservatism by increasing the LMI parameter N , of course at the price of increasing the complexity of the conditions, showing the tradeoff between conservatism and complexity.

2.6 Conclusions

In this chapter, an overview of stability analysis of time-delay systems related to the Lyapunov-Krasovskii theorem have been provided. After a brief presentation of time-delay systems model under consideration, a review of their basic properties and a survey of the main existing methods for deriving stability conditions in terms of LMI, a focus on the recent interests on integral inequalities is revealed. Several major results such as the Wirtinger-based integral inequality or its extended version, the Bessel-Legendre inequality, can be seen as the major contributions of this chapter. It was shown in this chapter how they can be easily used to derive highly competitive stability conditions with respect to the literature, both in terms of reduction of conservatism and complexity.

This chapter concentrates on the case of a single constant delays but several extensions have been provided for a larger class of problems (single or multiple delays, discrete or distributed, constant and time-varying). Several contributions regarding the case of time varying delays are not presented for the sake of consistency. The reader may refer to the following contributions where systems subject to time-varying delays are considered in [296, 295, 303], for Wirtinger-based integral inequality and related results or in [301, 191, 192, 365] for contributions related to Bessel-Legendre inequality and also similar inequalities, among many others. Nevertheless, several aspects of systems with time-varying delays will be presented in the next chapter dealing with the stability analysis of sampled-data systems. Indeed, there exists a strong connexion between sampled-data systems and systems subject to time-varying delays. This will be specified in the next chapter.

There are still some open problems related to the stability analysis of time-delay systems. Some of them will be presented in Chapter 4, where several perspectives will be presented. Finally I would like to emphasize that the framework of Bessel inequalities is not only applicable to time-delay systems but on a wider class of infinite dimensional systems, on which 2 PhD students M. Safi and M. Barreau are currently working. More details on their PhD subject will be provided in Chapter 4.

Chapter 3

Sampled-data systems

Contents

3.1	Introduction	49
3.2	Problem formulation and theoretical motivations	50
3.2.1	System data	50
3.2.2	A first stability result	51
3.2.3	An illustrative example	51
3.3	Input delay approach	53
3.3.1	Sampled-data systems modeled as fast-varying delay systems	53
3.3.2	Methodology to derive efficient stability conditions	54
3.3.3	Extensions & Limitations	60
3.4	Stability analysis using Looped-functionals	61
3.4.1	Basics of the Looped-functionals approach	62
3.4.2	Main result on asymptotic stability of sampled-data systems	62
3.4.3	What is a good structure for a looped functional?	64
3.5	Extensions and an emphasis to networked control systems	67
3.5.1	A brief overview of the latter achievements	67
3.5.2	Application to sampled-data dynamic output-feedback control under input saturations	69
3.6	Conclusions	74

3.1 Introduction

In the last decades, a large amount of attention has been devoted to Networked Control Systems (NCS) (see [153, 352]). Such systems are controlled systems containing several distributed plants which are connected through a communication network. In such applications, a heavy temporary load of computation in a processor can corrupt the sampling period of a given controller. Another phenomenon, which has been widely investigated, concerns stability under packet losses in wireless

networks, where the communication is not always guaranteed. In such situations, the variations of the sampling period will affect the stability properties. Thus an important issue is the development of robust stability conditions with respect to the variations of the sampling period.

Sampled-data systems have been extensively studied in the literature [60, 360, 361] and the references therein. The sampling interval can be constant, leading to a periodic sampling, of time-varying, usually called aperiodic or asynchronous samplings. It is now reasonable to design controllers which guarantee the robustness of the solutions of the closed-loop system under periodic samplings. However the case of asynchronous samplings still leads to several open problems. This corresponds to the realistic situation where the difference between two successive sampling instants is time-varying. The problem of robust sampled-data control consists in ensuring the stability of a closed-loop systems subject to external samplings. The sampling effects is seen as a disturbance to the nominal continuous-time system which has to be evaluated.

The study of aperiodic sampled-data systems has been addressed in several areas of research in Control Theory. Systems with aperiodic sampling can be seen as particular time-delay systems [105, 205]. Sampled-and-hold in control and sensor signals can be modelled using hybrid systems with impulsive dynamics [118, 119]. Aperiodic sampled-data systems have also been studied in the discrete-time domain [79, 66, 198, 149]. In particular, Linear Time Invariant (LTI) sampled-data systems with aperiodic sampling have been analyzed using discrete-time Linear Parameter Varying (LPV) models. The effect of sampling can be modelled using operators and the stability problem can be addressed in the framework of Input/Output interconnections as typically done in modern Robust Control [113, 168, 167, 166, 233]. While significant advances on this subject have been presented in the literature, problems related to both the fundamentals of such systems and the derivation of constructive methods for stability analysis remain open, even for the case of linear system.

This chapter aims at presenting the motivations for studying aperiodic sampled-data systems and two methods to assess stability. Both methods are based on a Lyapunov theorem and they give rise to stability conditions expressed in terms of Linear Matrix Inequalities (LMI).

3.2 Problem formulation and theoretical motivations

3.2.1 System data

Let $\{t_k\}_{k \in \mathbb{N}}$ be an increasing sequence of positive scalars such that $\bigcup_{k \in \mathbb{N}} [t_k, t_{k+1}) = [0, +\infty)$, for which there exist two positive scalars $\mathcal{T}_1 \leq \mathcal{T}_2$ such that

$$\forall k \in \mathbb{N}, \quad T_k = t_{k+1} - t_k \in [\mathcal{T}_1, \mathcal{T}_2]. \quad (3.1)$$

This sequence represents the sampling instants of the following sampled-data system

$$\forall t \in [t_k, t_{k+1}), \quad \dot{x}(t) = Ax(t) + Bu(t_k), \quad (3.2)$$

where $x \in \mathbb{R}^n$ and $u \in \mathbb{R}^m$ represent the state and the input vectors. The sequence $\{t_k\}_{k \in \mathbb{N}}$ represents the sampling instants of the controller. The matrices A and B are constant, known and of appropriate dimension. The control law is a linear state feedback, $u = Kx$ with a given gain $K \in \mathbb{R}^{m \times n}$. The system is governed by

$$\forall t \in [t_k, t_{k+1}), \quad \dot{x}(t) = Ax(t) + BKx(t_k). \quad (3.3)$$

3.2.2 A first stability result

In the situation where matrices A , B , and K are constant and known, and if in addition the sampling is periodic, meaning that $t_{k+1} - t_k$ is constant for all $k \geq 0$ and equal to a positive scalar T , system (3.3) can be formally integrated over a sampling period leading to the following discrete-time systems

$$\forall k \geq 0, \quad x(t_{k+1}) = \Lambda(A, B, K, T)x(t_k), \quad (3.4)$$

where the transition matrix Λ is given by

$$\Lambda(A, B, K, T) = e^{AT} + \int_0^T e^{A(T-s)} ds BK, \quad (3.5)$$

In this situation, the transition matrix Λ can be easily computed so that simple asymptotic stability conditions can be derived as follows.

Lemma 3.1

For given and known matrices A , B , K and a constant sampling period T , the following statements are equivalent:

- (i) System (3.3) is asymptotically stable;
- (ii) System (3.4) is asymptotically stable;
- (iii) The eigenvalues of $\Lambda(A, B, K, T)$ given in (3.5) are inside the unit circle;
- (iv) There exists a symmetric matrix P such that

$$P \succ 0, \quad \Lambda^T(A, B, K, T)P\Lambda(A, B, K, T) - P \prec 0.$$

The proof is not presented here but can be found in any text book on automatic control.

It is worth to notice that these conditions only apply to the quite restrictive situation description by the assumptions on the sampling period T , and on the system matrices. Indeed if the matrices A , B and K are unknown, uncertain or time-varying, several problem arise. First the notion of transition matrix is much more complicated in the time-varying case. Even in the situation of constant but uncertain matrices A , B , K , the stability analysis is not an easy task because the uncertainties propagate through the exponential matrix appearing in the definition of Λ . Only a few work have considered this problem [116, 115, 234]. It is however still possible to partially extend this lemma to the case of aperiodic sampling when the matrices A , B and K are constant and known. The reader may refer to [154, 79, 198, 148, 227, 226] where the authors have developed embedding methods to encapsulate the uncertain matrix Λ into a polytopic representation so that the fourth item of the previous lemma using Lyapunov function can still be applied. Partially indeed, since the third item does not hold anymore.

3.2.3 An illustrative example

In the sequel, a counter example is provided. The objectives of the end this section is to motivate the theoretical key issues related to this class of systems through a couple of examples. Let us first

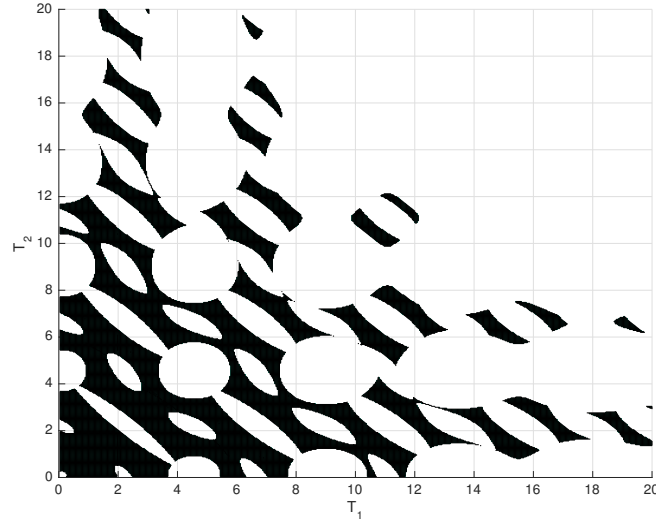

Figure 3.1: Stability region in the plan (T_1, T_2) of sampled-data system (3.6) with the sampling rule (3.7). The black areas corresponds to stable behaviors of the sampled-data system (3.6).

consider the following example taken from the literature on time-delay systems. This particular systems, which can be interpreted as an open-loop unstable oscillatory system given by

$$\begin{aligned} \dot{x}(t) &= \begin{bmatrix} 0 & 1 \\ -2 & 0.1 \end{bmatrix} x(t) + \begin{bmatrix} 0 \\ 1 \end{bmatrix} u(t_k) \\ u(t) &= \begin{bmatrix} k & 0 \end{bmatrix} x(t) \end{aligned} \quad (3.6)$$

This system cannot be controlled through a static output-feedback controller since, whatever the possible controller gain k , the matrix representing the closed-loop system given by $\begin{bmatrix} 0 & 1 \\ -2+k & 0.1 \end{bmatrix}$ will always have at least a positive eigenvalue since its trace is equal to $0.1 > 0$ for all values of k . It is then expected that a continuous static output feedback is not able to stabilize such a system. Nevertheless, it is possible to stabilize the closed-loop system with a sampled version of the control law $u(t)$, of course if the sampling intervals are selected in an appropriate manner.

To illustrate this issue as well the asynchronous sampling case, let us consider the situation where this control $u(t)$ with $k = 1$ is sampled as follows

$$T_k = t_{k+1} - t_k = \begin{cases} T_1, & \text{if } k \text{ is odd} \\ T_2, & \text{otherwise} \end{cases} \quad (3.7)$$

Using an eigenvalue analysis of the transition matrix representing the evolution of the system state after two successive sampling instants (i.e. $|\Lambda(A, B, T_1)\Lambda(A, B, T_2)| < 1$) leads to the stability region depicted in Figure 3.1. This example illustrates the inherent complexity of sampled-data in the aperiodic case. Indeed, we first can see that there exist stabilizable values of T_1 and T_2 while the continuous-time systems (i.e. $T_1 = T_2 = 0$) is unstable. Second, the case of periodic sampling ($T = T_1 = T_2$) has several non connexe regions located around $T = 1, 3, 6, 7, 11$ and 12 . Finally the aperiodic case, represented for instance by the scheduler (3.7) is much more complex and recall results on on the stability of time-driven switched [186]. For instance, the periodic sampled-data

systems (3.6)-(3.7) with $T_1 = T_2 = 1.5$ and $T_1 = T_2 = 3$ are stable, while the aperiodic case $T_1 = 1.5$ and $T_2 = 3$ leads to instability.

This example also illustrates the necessity to provide efficient and robust stability analysis of sampled-data systems based on the application of the Lyapunov theorem. In the remainder of this chapter, two possible solutions for such robust analysis will be provided. The first one is based on a delay modeling for sampled-data systems while the second one is more related to an equivalence formulation of the discrete-time stability criteria (iv) but expressed with the continuous-time system matrices.

3.3 Input delay approach

Modelling of continuous-time systems with digital control in the form of continuous-time systems with delayed control input was introduced by [205], [20] and further developed by [95]. The digital control law may be represented as delayed control as follows:

$$u(t) = u_d(t_k) = u_d(t - (t - t_k)) = u_d(t - \tau(t)), \quad t_k \leq t < t_{k+1}, \quad \tau(t) = t - t_k, \quad (3.8)$$

where u_d is a discrete-time control signal and the time-varying delay $\tau(t) = t - t_k$ is piecewise-linear with derivative $\dot{\tau}(t) = 1$ for $t \neq t_k$. Moreover, $\tau \leq t_{k+1} - t_k$. Based on such a model, for small enough sampling intervals $t_{k+1} - t_k$ asymptotic approximations of the trajectory [205] and of the optimal solution to the sampled-data LQ finite horizon problem [95] were constructed.

3.3.1 Sampled-data systems modeled as fast-varying delay systems

Consider the linear sampled-data system (3.2). We represent a piecewise-constant control law as a continuous-time control with a time-varying piecewise-continuous (continuous from the right) delay $\tau(t) = t - t_k$ as given in (3.8). Substituting the sampled version of the control input $u(t_k)$ (or the state vector $x(t_k)$) into (3.2), we obtain the following closed-loop system, represented as a linear system subject to the time varying delay

$$\dot{x}(t) = Ax(t) + BKx(t - \tau(t)), \quad \tau(t) = t - t_k, \quad t_k \leq t < t_{k+1}. \quad (3.9)$$

The constraints on the sampling interval provided in (3.1) are still considered. From these constraints, it follows that the sampling delay $\tau(t)$ has a sawtooth form and belongs to the interval $[0, \mathcal{T}_2]$ since $\tau(t) \leq t_{k+1} - t_k \leq \mathcal{T}_2$. An example of such time-varying delay is depicted in Figure 3.2. This figure shows how the impact of this particular delay function when it is applied to a simple sine function. Indeed, the resulting signal $\sin(t - \tau(t)) = \sin(t_k)$, for some arbitrarily selected sampling instants, can be seen as a sampled-and-hold version of the sine function.

Unlike classical assumptions on delay functions usually considered in the literature of systems subject to a time-varying delay, this particular sampling delay has two particular features and characteristics, due to its sawtooth shape. The first one is due to the fact that the delay function is reset to zero at every sampling time. This reset corresponds to the jump of the sampled function at the sampling instant. The second characteristic is related to the derivative of the delay function between two successive sampling instants. Indeed we note that $\dot{\tau}(t) = 1$ almost at all time except at the sampling instants. This corresponds to the "hold" nature of the resulting sampling-and-hold function. Since

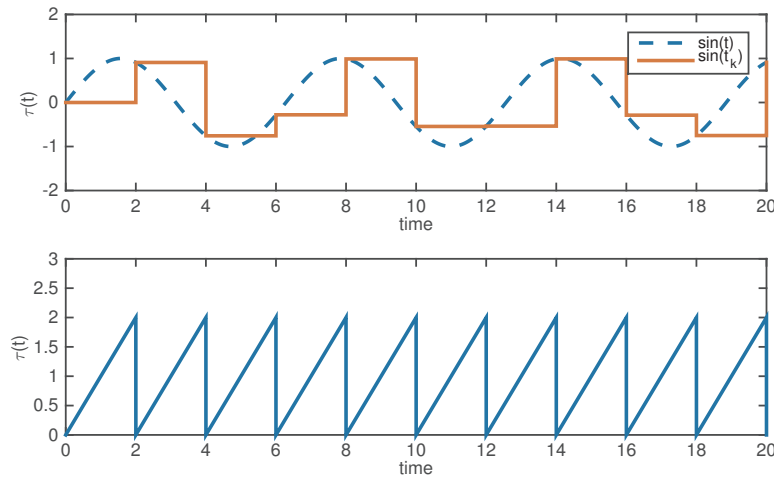

Figure 3.2: Illustration of a periodic sampling delay $\tau(t)$.

the delay increase at the same speed as the time variable, the resulting delayed version of the sine function keep constant in the inter-sampling time.

This two characteristics of the sampling delay function $\tau(t)$ requires a particular attention when one aims at assessing stability of the delay. This sampling delay function is often seen as a particular class of time-varying delay function, often called *fast-varying delays*, which include the sawtooth delay function as a particular case. Therefore, modeling of a sampled-data system by a system subject to this particular time-varying delay has the merit to allow the derivation of stability conditions issued by application of the Lyapunov-Krasovskii theorem, which was already presented in the previous chapter.

In the next developments, an example of stability conditions for sampled-data systems based on the Lyapunov-Krasovskii theorem is provided. Through this simple formulation, we will present as in the previous chapter on the stability analysis of time-delay systems a methodology to derive stability conditions expressed in terms of LMIs. Several comments and remarks allow one to extend this theorem and to reduce its associated conservatism. Finally a discussion on the limitations and possible extensions will be discussed hereafter.

3.3.2 Methodology to derive efficient stability conditions

Following the methodology presented in Chapter 2 on the stability analysis of time-delay systems using Lyapunov-Krasovskii functionals, there are several steps to follow in order to derive efficient stability conditions for sampled-data systems. The derivation of stability conditions of sampled-data systems based on the input delay approach follows typically four steps. These steps are obviously very similar to the procedure presented in Chapter 2 on the stability of linear systems subject to constant delays. Nevertheless, an additional technical step is included to this procedure to account for the variations of the delay function. The procedure follows the four following items.

- **Step 1:** *Selection of the functional;*
- **Step 2:** *Differentiation of the functional along the trajectories of the system;*
- **Step 3:** *Application of integral inequalities;*

- **Step 4:** *Application of matrix inequalities.*

In order to illustrate this methodology, we present one of the simplest theorem, involving only few matrix variables. This theorem is stated below.

Theorem 3.1

Assume that there exist matrices P, S, R in \mathbb{S}_+^n , and a matrix X in $\mathbb{R}^{n \times n}$. such that the following LMIs are satisfied

$$\Phi = \Phi_0 - (G_2 - G_3)^\top R (G_2 - G_3) \prec 0, \quad (3.10)$$

where

$$\Phi_0(h) = G_1^\top P G_0 + G_0^\top P G_1 + \begin{bmatrix} S & 0 & 0 \\ * & 0 & 0 \\ * & * & -S \end{bmatrix} + \mathcal{T}_2^2 G_0^\top R G_0,$$

$$\begin{aligned} G_0 &= \begin{bmatrix} A & A_d & 0 \end{bmatrix}, & G_1 &= \begin{bmatrix} I & 0 & 0 \end{bmatrix}, \\ G_2 &= \begin{bmatrix} I & -I & 0 \end{bmatrix}, & G_3 &= \begin{bmatrix} 0 & I & -I \end{bmatrix}. \end{aligned}$$

Then, time-delay system (3.9) is asymptotically stable for all delay $\tau(t) \in [0, \mathcal{T}_2]$. As a direct consequence, sampled-data system (3.3) is also asymptotically stable for all samplings $\{t_k\}_{k \geq 0}$ satisfying (3.1).

In the proof of this theorem, we will point out the main steps of this methodology and provide a list of references where improvements with respect to this simple version can be found.

Proof: The proof aims at illustrating the procedure for deriving stability conditions for sampled-data systems using the input delay approach. Throughout this proof, a list of possible extensions is provided to understand the various ways to refine the resulting conditions.

Step 1: *Selection of the functional*

One of the simplest case considers the following Lyapunov-Krasovskii functional to be considered for sampled-data systems is given by

$$V(x_t, \dot{x}_t) = x^\top(t) P x(t) + \int_{t-\mathcal{T}_2}^t x^\top(s) S x(s) ds + \mathcal{T}_2 \int_{-\mathcal{T}_2}^0 \int_{t+\theta}^t \dot{x}^\top(s) R \dot{x}(s) ds. \quad (3.11)$$

This type of functionals (or similar ones) was first presented in [96, 108] and latter work of E. Fridman. The potential of this method among the existing ones at that time, it the possibility to derive delay dependent stability conditions, which are as independent on the derivative of the delay function, allowing then an extension to sampled-data systems in [105]. This functional is composed of the sum of three terms, one quadratic term express with the instantaneous state vector $x(t)$ and two integral quadratic terms depending on the state x_t and \dot{x}_t considered over the interval $[t - \mathcal{T}_2, t]$. The positive definiteness of this functional is guaranteed by the positive definiteness of the matrices P, S and R . Unlike in the time-varying delay case, the particular properties of the delay function $\tau(t)$ make useless the consideration of integral quadratic terms considered over the interval $[t - \tau(t), t]$. For instance, if one considers the integral quadratic term

$$V_Q(x_t) = \int_{t-\tau(t)}^t x^\top(s) Q x(s) ds,$$

where Q is a positive definite matrix, it is easy to see that

$$\dot{V}_Q(x_t) = x^\top(t)Qx(t) - \frac{d}{dt}(t - \tau(t))x^\top(t - \tau(t))Qx(t - \tau(t)) = x^\top(t)Qx(t) \geq 0,$$

is positive definite. Then this term is penalizing and does not help to obtain the negative definiteness of the functional. It is however possible to enrich the functional with additional and complementary terms. For instance, [326] introduces triple integral terms, or [13] considered the augmented state vector $[x^\top(s) \dot{x}^\top(s)]^\top$. Another possibility to enrich the first quadratic term by considering an augmented state

$$\left[x^\top(t) \int_{t-\mathcal{T}_2}^t x^\top(s)ds \right]^\top \text{ or } \left[x^\top(t) \int_{t-\tau(t)}^t x^\top(s)ds \int_{t-\mathcal{T}_2}^{t-\tau(t)} x^\top(s)ds \right]^\top,$$

as in [303]. Note that this state augmentation is closely related to **Step 3** on the use of *efficient integral inequalities*.

Step 2: *Differentiation of the functional along the trajectories of the system*

The computation of the derivative of the functional relies in quite standard mathematical and technical manipulations. However, one particular and crucial goal in this step consists in expressing the derivative of V as a quadratic term defined with a well suited augmented vector. In our particular case, the simplest augmented vector ζ is given by

$$\zeta(t) = \begin{bmatrix} x(t) \\ x(t - \tau(t)) \\ x(t - \mathcal{T}_2) \end{bmatrix}.$$

Indeed it is easy to see that the vectors $x(t)$ and $\dot{x}(t)$ can be simply expressed using $\zeta(t)$ and the following relations hold $\dot{x}(t) = G_1\zeta(t)$ and $x(t) = G_0\zeta(t)$. Hence, the computation of the derivative of the functional along the trajectories of the system leads to

$$\begin{aligned} \dot{V}(x_t) = & \zeta^\top(t) \left(G_1^\top P G_0 + G_0^\top P G_1 + \begin{bmatrix} S & 0 & 0 \\ * & 0 & 0 \\ * & * & -S \end{bmatrix} + \mathcal{T}_2^2 G_0^\top R G_0 \right) \zeta(t) \\ & - \mathcal{T}_2 \int_{t-\mathcal{T}_2}^t \dot{x}^\top(s) R \dot{x}(s) ds, \end{aligned} \quad (3.12)$$

where the matrix G_0 and G_1 are given in the statement of Theorem 3.1. Depending on the purpose (i.e. robust stability analysis or stabilization), the selection of this augmented vector $\zeta(t)$ is not necessarily the most appropriate. Indeed, in the literature, several contributions have employed the following modified vector

$$\bar{\zeta}(t) = \begin{bmatrix} x(t) \\ \dot{x}(t) \\ x(t - \tau(t)) \\ x(t - \mathcal{T}_2) \end{bmatrix},$$

which, in comparison to ζ also includes the derivative of the instantaneous state vector $\dot{x}(t)$. Then, one has to account for the linking condition $Ax(t) - \dot{x}(t) + BKx(t - \tau(t))$ in the system data. This method was first considered in the descriptor formulation developed in [96, 108, 97, 108] to

cite only few. The descriptor approach can somehow be seen as the free-weighting matrix method [144, 353]. It is worth noting that these two formulations can be interpreted as the application of the Finsler Lemma [320]. For more details, the reader can refer to [129, 144] for more explanations.

Step 3: Application of integral inequalities

As in the time-delay systems case, the expression of \dot{V} in (3.12) involves a negative integral quadratic term which can not be directly included in an LMI formulation. It thus remains to include this negative contribution into the quadratic term depending on the augmented vector $\zeta(t)$. To do so, we employ the Jensen's inequality, presented in Chapter 2, but recalled here for consistency.

Lemma 3.2

For a given scalar $a < b$, a $n \times n$ -matrix $R \succ 0$ and for any piecewise continuous function x in $[a, b] \rightarrow \mathbb{R}^n$, the following inequality holds:

$$\int_a^b x^\top(u) R x(u) du \geq \frac{1}{b-a} \Omega_0^\top(x) R \Omega_0(x), \quad (3.13)$$

where $\Omega_0(x) = \int_a^b x(u) du$.

Unlike the constant delay case, one has to split the integral term into two parts in order to explicitly introduce the time $t - \tau(t)$ before applying the integral inequality. This yields

$$\begin{aligned} -\mathcal{T}_2 \int_{t-\mathcal{T}_2}^t \dot{x}^\top(s) R \dot{x}(s) ds &= -\mathcal{T}_2 \int_{t-\tau(t)}^t \dot{x}^\top(s) R \dot{x}(s) ds - \mathcal{T}_2 \int_{t-\mathcal{T}_2}^{t-\tau(t)} \dot{x}^\top(s) R \dot{x}(s) ds \\ &\leq -\frac{\mathcal{T}_2}{\tau(t)} (x(t) - x(t - \tau(t)))^\top R (x(t) - x(t - \tau(t))) \\ &\quad - \frac{\mathcal{T}_2}{\mathcal{T}_2 - \tau(t)} (x(t - \tau(t)) - x(t - \mathcal{T}_2))^\top R (x(t - \tau(t)) - x(t - \mathcal{T}_2)). \end{aligned}$$

Using matrices G_2 and G_3 are given in the statement of Theorem 3.1, the previous inequality can be rewritten in a more compact form as follows

$$-\mathcal{T}_2 \int_{t-\mathcal{T}_2}^t \dot{x}^\top(s) R \dot{x}(s) ds \leq -\zeta^\top(t) \begin{bmatrix} G_2 \\ G_3 \end{bmatrix}^\top \begin{bmatrix} \frac{\mathcal{T}_2}{\tau(t)} R & 0 \\ * & \frac{\mathcal{T}_2}{\mathcal{T}_2 - \tau(t)} R \end{bmatrix} \begin{bmatrix} G_2 \\ G_3 \end{bmatrix} \zeta(t).$$

We first note that the previous expression is still valid when $\tau(t)$ tends to 0 or \mathcal{T}_2 since we have

$$\lim_{\tau(t) \rightarrow 0} \frac{G_2 \zeta(t)}{\tau(t)} = \frac{x(t) - x(t - \tau(t))}{\tau(t)} = \dot{x}(t),$$

$$\lim_{\tau(t) \rightarrow \mathcal{T}_2} \frac{G_3 \zeta(t)}{\mathcal{T}_2 - \tau(t)} = \frac{x(t - \tau(t)) - x(t - \mathcal{T}_2)}{\mathcal{T}_2 - \tau(t)} = \dot{x}(t - \mathcal{T}_2).$$

This remark avoids any future discussion on the validity of the upper bound of the integral term when $\tau(t)$ tends to 0 or \mathcal{T}_2 . As for time-delay systems, the use of the Jensen inequality unavoidably introduces conservatism in the resulting stability conditions. Again, it is possible to replace Lemma 3.2 by other recent and less conservative integral inequalities. Since this discussion was already considered in Chapter 2, this possibility will not be further developed in this chapter.

To stay short, possible extension can be done by considering the Wirtinger-based integral inequality [296], the auxiliary function-based integral inequality [244], the Bessel-Legendre inequality [298] or free matrix-based integral inequality [353]. Note, however, that there are additional difficulties when employing these inequalities for sampled-data systems or systems with fast-varying delays. Some of the difficulties arises in the derivation of convex LMI stability conditions. There are however some technical details when employing more involved integral inequalities that require a lot of attention. This will not be detailed in this manuscript but the reader may refer to [303] and [192] for more details about these extensions with the Wirtinger-based integral and a limited version of the Bessel-Legendre inequality, respectively.

Step 4: *Application of matrix inequalities*

At the end of **Step 3**, we were able to derive a lower bound of the integral quadratic term and we have obtain the following upper of the derivative of the functional

$$\begin{aligned} \dot{V}(x_t, \dot{x}_t) \leq & \zeta^\top(t) \left(G_1^\top P G_0 + G_0^\top P G_1 + \begin{bmatrix} S & 0 & 0 \\ * & 0 & 0 \\ * & * & -S \end{bmatrix} \right. \\ & \left. + \mathcal{T}_2^2 G_0^\top R G_0 - \begin{bmatrix} G_2 \\ G_3 \end{bmatrix}^\top \begin{bmatrix} \frac{1}{\alpha} R & 0 \\ * & \frac{1}{1-\alpha} R \end{bmatrix} \begin{bmatrix} G_2 \\ G_3 \end{bmatrix} \right) \zeta(t), \end{aligned} \quad (3.14)$$

where we use the notation $\alpha = \frac{\tau(t)}{\mathcal{T}_2}$ for simplicity. In order to guarantee that the derivative of the functional \dot{V} is negative definite, one must ensure that the LMI

$$G_1^\top P G_0 + G_0^\top P G_1 + \begin{bmatrix} S & 0 & 0 \\ * & 0 & 0 \\ * & * & -S \end{bmatrix} + \mathcal{T}_2^2 G_0^\top R G_0 - \begin{bmatrix} G_2 \\ G_3 \end{bmatrix}^\top \begin{bmatrix} \frac{1}{\alpha} R & 0 \\ * & \frac{1}{1-\alpha} R \end{bmatrix} \begin{bmatrix} G_2 \\ G_3 \end{bmatrix} \prec 0,$$

holds for all α in the interval $(0, 1)$. This is however not an easy task since the last term of the previous matrix inequality is not convex with respect to α . Therefore, in order to derive tractable LMI stability conditions, one has to provide a tractable and convex upper bound of this term, which is not an easy task, a priori. Among the most popular methods, one may refer to the Moon *et al* inequality [211], presented in the following lemma.

Lemma 3.3

For given positive definite matrix R in \mathbb{S}^n and matrices G_2, G_3 in $\mathbb{R}^{n \times 3n}$, the inequality

$$\begin{bmatrix} G_2 \\ G_3 \end{bmatrix}^\top \begin{bmatrix} \frac{1}{\alpha} R & 0 \\ 0 & \frac{1}{1-\alpha} R \end{bmatrix} \begin{bmatrix} G_2 \\ G_3 \end{bmatrix} \geq He \left\{ \begin{bmatrix} N_1 \\ N_2 \end{bmatrix}^\top \begin{bmatrix} G_2 \\ G_3 \end{bmatrix} \right\} - \alpha N_1^\top R^{-1} N_1 - (1-\alpha) N_2^\top R^{-1} N_2,$$

holds for any matrices $N_1, N_2 \in \mathbb{R}^{3n \times n}$ and for all α in $(0, 1)$.

Proof: The proof of this lemma results from the expansion of the two following squares

$$\frac{1}{\alpha} (R G_2 - \alpha N_1)^\top R^{-1} (R G_2 - \alpha N_1) + \frac{1}{1-\alpha} (R G_3 - (1-\alpha) N_2)^\top R^{-1} (R G_3 - (1-\alpha) N_2) \geq 0.$$

◇

This lemma has been widely used in the literature in different (and some hidden) forms. It is numerically efficient but at the price of a notable increase of the number of decision variables, in this case $6n^2$.

Recently, an efficient method, called the reciprocally convex combination lemma has been proposed in [243], and has shown its efficiency on stability theorem based on the Jensen's inequality. Indeed it allows retrieving the same numerical results as the ones issued from the application of Lemma 3.3 but with a lower number of decision variables (n^2 instead of $6n^2$). This lemma is stated below.

Lemma 3.4

Given a matrix $R \in \mathbb{S}_+^n$, and two matrices G_2 and G_3 in $\mathbb{R}^{n \times 3n}$, then the improved reciprocally convex combination guarantees that, if there exists a matrix X in $\mathbb{R}^{n \times n}$ such that

$$\begin{bmatrix} R & X \\ X^\top & R \end{bmatrix} \succeq 0,$$

then, the following matrix inequality holds for all $\alpha \in (0, 1)$

$$\begin{bmatrix} \frac{1}{\alpha}R & 0 \\ 0 & \frac{1}{1-\alpha}R \end{bmatrix} \succeq \begin{bmatrix} R & X \\ X^\top & R \end{bmatrix}.$$

Proof: A proof can be found in [243] to consider a larger class of reciprocally convex combination. A simpler and more dedicated proof is provided here. Define the scalar $\beta = \sqrt{\frac{1-\alpha}{\alpha}}$. Then, we have, by congruence

$$0 \preceq \begin{bmatrix} \beta I & 0 \\ 0 & -\beta^{-1}I \end{bmatrix} \begin{bmatrix} R & X \\ X^\top & R \end{bmatrix} \begin{bmatrix} \beta I & 0 \\ 0 & -\beta^{-1}I \end{bmatrix} = \begin{bmatrix} \frac{1-\alpha}{\alpha}R & -X \\ -X^\top & \frac{\alpha}{1-\alpha}R \end{bmatrix} = \begin{bmatrix} \frac{1}{\alpha}R & 0 \\ 0 & \frac{1}{1-\alpha}R \end{bmatrix} - \begin{bmatrix} R & X \\ X^\top & R \end{bmatrix},$$

which concludes the proof. \diamond

A slightly modified version of this lemma has the benefit over the two previous lemmas, to not introduce any additional slack variables. Indeed, no additional slack variables are introduced and, more generally, the complexity is reduced since no additional LMI needs to be included, which represents a notable advantage over the previous method.

Lemma 3.5

Given a matrix $R \in \mathbb{S}_+^n$, then the reduced reciprocally convex combination guarantees that the following matrix inequality holds for all $\alpha \in (0, 1)$

$$\begin{bmatrix} \frac{1}{\alpha}R & 0 \\ 0 & \frac{1}{1-\alpha}R \end{bmatrix} \succeq \begin{bmatrix} R & -R \\ -R & R \end{bmatrix}.$$

Proof: The proof can be derived by selected $X = -R$ in Lemma 3.4. \diamond

Note that, an interpretation of this lemma has been provided in [305], where the combination of the Jensen inequality with the reciprocally convex combination lemma has been interpreted as a

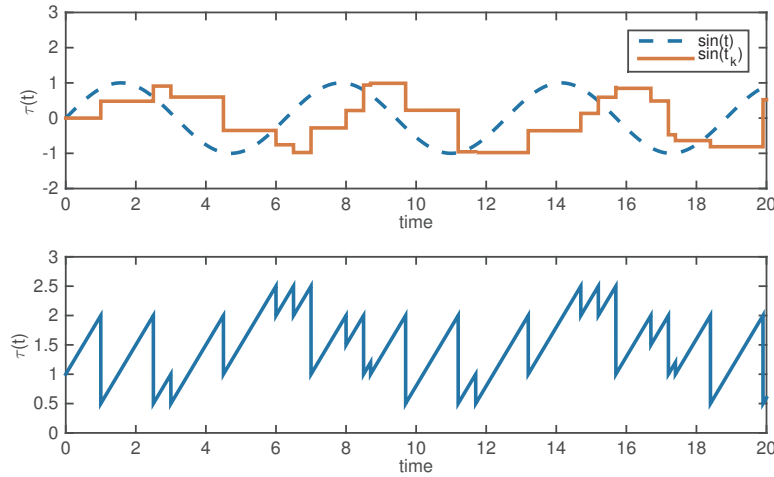

Figure 3.3: Illustration of a sampling delay $\tau(t)$ including a communication delay.

discretized version of Jensen's inequality. While Lemmas 3.3, 3.4 and 3.5 lead to the same level of conservatism when employing the Jensen inequality and the same functional (3.11), it has been revealed in [191] that the second and the third one are more conservative than the first one when employing the Wirtinger-based inequality. Based on this remark, further improvements of Lemma 3.4 have been provided in the literature. The reader may refer to the so-called relaxed reciprocally convex lemma [356, 357] or to a delay-dependent version of this lemma, which has been provided in [299, 365]. Nonetheless, all these improvements can be interpreted as particular cases of Moon's inequality presented in Lemma 3.3, with a particular structure for the slack matrices N_1 and N_2 as discussed in [191, 307].

Let us conclude the proof of asymptotic stability of the sampled-data system (3.3). In order to obtain the stability conditions from Theorem 3.1, we apply Lemma 3.5 with $\alpha = \tau(t)/\tau_2$, which implies that the following inequality holds $\dot{V}(x_t, \dot{x}_t) \leq \zeta^\top(t)\Phi\zeta(t)$. Hence, system (3.9) subject to the uncertain delay $\tau(t)$ is asymptotically stable for all delay $\tau(t) \in [0, \tau_2]$ and for all sequence if the LMI $\Phi \prec 0$ is satisfied. As a consequence, sampled-data system (3.3) is also asymptotically stable for any sampling sequence $\{t_k\}_{k \geq 0}$ verifying (3.1). \diamond

3.3.3 Extensions & Limitations

The input delay approach has been widely used in the literature since [105]. This method has permitted many researchers working on time-delay systems to develop further stability, stabilization and observation conditions for sampled-data systems and, more generally, for networked control systems. In addition to this non exhaustive list of possible applications, the input delay approach have the particular advantage to be straightforwardly applicable to the situation of mixed sampled-data and delayed systems where the control input or the output are not only sampled, possibly in an asynchronous manner, but also to be affected by an additional delay, which is usually interpreted as a communication delay. The resulting system can still be seen as a delay system but the overall sawtooth delay function is shifted as presented in Figure 3.3. Eventhough, this method has a major

drawback, which is already pointed out in the statement of Theorem 3.1. Indeed the stability conditions proposed in this theorem is not only dedicated to the sole class of sampled-data systems but the more general class of delay systems subject to a fast-varying delay. The particular characteristics of the sawtooth delay function described above (i.e. $\dot{\tau}(t) = 1$ for almost all t , and the jump at the sampling instants) are not specifically included in the design of the functional. Therefore, the resulting stability conditions are by nature conservative. A notable extension of this method was provided in [218, 219, 220]. The main contribution of these papers was to include in the design of the Lyapunov-Krasovskii functional the hybrid or impulsive nature of sampled-data systems. The main idea is to consider an additional Lyapunov term of the form

$$V_{Imp}(x_t, t) = (T_k - \tau(t))(x(t) - x(t - \tau(t)))^\top Q(x(t) - x(t - \tau(t))).$$

where $Q > 0$ and we recall that $T_k = t_{k+1} - t_k$. This term allows including more information on the sampled-data system through the following aspects. First, this term depends explicitly on the delay function $\tau(t)$ (or on the time variable t). Then when computing the derivative of V_{Imp} with respect to time, the constraint $\dot{\tau}(t) = 1$ appears naturally for all $t \neq t_k$. It also allows to include the additional characteristic of the sampled and hold term $x(t_k) = x(t - \tau(t))$. Indeed, when computing the derivative of V_{Imp} with respect to time, the constraint $\dot{x}(t_k) = \frac{d}{dt}x(t - \tau(t)) = 0$ also appears naturally. However, one has to note that this term is discontinuous at the sampling instant. It thus remains to prove that this term behave well at the sampling instants. To do so, we need to ensure

$$V_{Imp}(x_{t_k}, t_k) \geq V_{Imp}(x_{t_k^+}, t_k^+) = \lim_{s \rightarrow t_k, s \geq t_k} V_{Imp}(x_s, s), \quad \forall k \geq 0.$$

This constraint is guaranteed by noting that, at time $t = t_k$, functional $V_{Imp}(x_{t_k^+}, t_k^+)$ is zero, by construction, since $x(t_k^+) = x(t_k^+ - \tau(t_k^+))$ and $V_{Imp}(x_{t_k}, t_k) \geq 0$, since matrix Q is positive definite. The reader may refer to the following notable extension of this impulsive approach in [100, 188, 189, 277, 278], among many other contributions from the literature.

As a remark, another notable contribution to this impulsive system approach was presented in [190]. The main idea is based on the construction of a simple discontinuous Lyapunov term whose positive definiteness relies on the application of Wirtinger inequality. This Lyapunov term is of the following form

$$V_W(x_t) = \mathcal{T}_2^2 \int_{t_k}^t \dot{x}^\top(s) Z \dot{x}(s) ds - \frac{\pi^2}{4} \int_{t_k}^t (x(s) - x(t_k))^\top Z (x(s) - x(t_k)) ds$$

for a given positive definite matrix Z . More details on this Lyapunov term can be found in [190]. The merits of this approach are twofolds. First, a direct extension allow including an additional constant communication delay to the sampled-data term $x(t_k)$ which would becomes $x(t_k - \eta)$ for some constant delay $\eta > 0$. Second it provides an equivalent Lyapunov analysis of the robust analysis provided in [209], which also uses an argument issued from the application of the Wirtinger inequality to derive upper bound of the sampling and hold operator. Note that an analogous version of this Lyapunov term was provided in [291] to assess stability of discrete-time sampled-data systems.

3.4 Stability analysis using Looped-functionals

In the previous section, a brief review of the input delay approach and of the impulsive systems approach have been provided. In this section another method is presented and aims at relaxing some

constraints on the functionals, providing then a real alternative to the application of the Lyapunov-Krasovskii theorem and, to some extent, to the *Hybrid Dynamical Systems* employed in the impulsive system approach. This method is based on the so-called *Looped-functional* approach, relying on the definition of a shifted state function. This approach was motivated by the lack of links in the literature between the stability analysis issued from the discretized model of a sampled-data systems, provided in the fourth item of Lemma 3.1 and the input delay approach described in the previous section.

3.4.1 Basics of the Looped-functionals approach

Consider the sampled-data system still described by dynamics (3.3). Let us define the shifted state function χ_k , defined for all $k \geq 0$. This shifted state function corresponds to the trajectory of the sampled-data system considered during the sampling interval. This new infinite dimensional function is defined by

$$\chi_k(\tau) = x(t_k + \tau), \quad \forall \tau \in [0, T_k] \subset [0, \mathcal{T}_2]. \quad (3.15)$$

with the particular transition equation $x(t_{k+1}) = \chi_k(T_k) = \chi_{k+1}(0)$. In the sequel, we say that such a shifted function belongs to the set $\mathbb{K}^n := \{x : [0, \mathcal{T}_2] \rightarrow \mathbb{R}^n\}$. By integration of sampled-data systems (3.3), we note that

$$\chi_k(\tau) = \Lambda(A, B, K, \tau)\chi_k(0), \quad \forall \tau \in [0, T_k] \subset [0, \mathcal{T}_2], \quad (3.16)$$

where Λ given in (3.5) can be seen as a transition matrix for (3.3) from time $t = t_k$ (or $\tau = 0$) to any time instant $t \in [t_k, t_{k+1})$ (or to any $\tau \in [0, T_k)$). The dynamics of the shifted state χ_k is straightforwardly given by

$$\dot{\chi}_k(\tau) = \frac{d}{d\tau}\Lambda(A, B, K, \tau)\chi_k(0) = A\chi_k(\tau) + BK\chi_k(0). \quad (3.17)$$

Based on the previous definition of the shifted state $\chi_k \in \mathbb{K}^n$, we will provide in the next section a novel stability theorem which allows filling the gap between the discrete stability conditions from the input delay approach and the discrete-time approaches.

3.4.2 Main result on asymptotic stability of sampled-data systems

Let us present the first theorem considering Looped-functionals. This method presented in [280], proposes an equivalence between the discrete-time and the continuous-time approaches. It notably allows a relaxation of the Lyapunov-Krasovskii theorem when assessing stability of the particular case of sampled-data systems. This result is stated in the following theorem.

Theorem 3.2

Let $0 < \mathcal{T}_1 \leq \mathcal{T}_2$ be two positive scalars and $V : \mathbb{R}^n \rightarrow \mathbb{R}^+$ be a differentiable function for which there exist positive scalars $\mu_1 < \mu_2$ and p such that

$$\forall x \in \mathbb{R}^n, \quad \mu_1|x|^p \leq V(x) \leq \mu_2|x|^p. \quad (3.18)$$

Then the two following statements are equivalent.

- (i) The increment of the Lyapunov function is strictly negative for all $k \in \mathbb{N}$ and $T_k \in [\mathcal{T}_1, \mathcal{T}_2]$, i.e.,

$$\Delta_0 V(k) = V(\chi_k(T_k)) - V(\chi_k(0)) < 0;$$

- (ii) There exists a continuous and differentiable functional $\mathcal{V}_0 : [0, \mathcal{T}_2] \times \mathbb{K}^n \rightarrow \mathbb{R}$ which satisfies the looping condition for all $z \in \mathbb{K}$

$$\forall T \in [\mathcal{T}_1, \mathcal{T}_2] \quad \mathcal{V}_0(T, z(\cdot)) = \mathcal{V}_0(0, z(\cdot)) \quad (= 0), \quad (3.19)$$

and such that, for all $(k, T_k, \tau) \in \mathbb{N} \times [\mathcal{T}_1, \mathcal{T}_2] \times [0, T_k]$,

$$\dot{\mathcal{W}}_0(\tau, \chi_k) = \frac{d}{d\tau} [V(\chi_k(\tau)) + \mathcal{V}_0(\tau, \chi_k)] < 0. \quad (3.20)$$

Moreover, if one of these two statements is satisfied, then sampled-data system (3.3) is asymptotically stable for any sampling sequence $\{t_k\}_{k \geq 0}$ satisfying (3.1).

Proof: Let $k \in \mathbb{N}$, $T_k \in [\mathcal{T}_1, \mathcal{T}_2]$ and $\tau \in [0, T_k]$ as described in (3.1). Assume that (ii) is satisfied. Integrating $\dot{\mathcal{W}}_0$ with respect to τ over $[0, T_k]$ and assuming that (3.19) holds, this leads to $\int_0^{T_k} \dot{\mathcal{W}}_0(\tau, \chi_k) d\tau = \Delta_0 V(k)$. Then $\Delta_0 V(k)$ is strictly negative since $\dot{\mathcal{W}}_0$ is negative over $[0, T_k]$.

Assume now that (i) holds. Let us introduce the functional

$$\mathcal{V}_0(\tau, \chi_k) = \frac{\tau}{T_k} [V(\chi_k(T_k)) - V(\chi_k(0))] - [V(\chi_k(\tau)) - V(\chi_k(0))],$$

as in Lemma 2 in [248]. By simple computations, it is easy to see that it satisfies the boundary conditions (3.19), i.e.

$$\mathcal{V}_0(0, \chi_k) = \mathcal{V}_0(T_k, \chi_k) = 0,$$

and $\dot{\mathcal{W}}_0(\tau, \chi_k) = \Delta_0 V(k)/T_k$. This proves the equivalence between (i) and (ii).

The function $\Lambda(\cdot)$ is continuous and consequently bounded over $[0, \mathcal{T}_2]$. Then equations (3.15) and (3.16) proves that $x(t)$ and the continuous Lyapunov function, V , uniformly and asymptotically tends to zero. \diamond

Remark 3.1

In order to guarantee asymptotic stability of (3.3), the transition matrix Λ has to be bounded over the interval $[0, \mathcal{T}_2]$. This represents a crucial step to this proof, which prevents from extension to general classes of nonlinear systems. Nevertheless, it is still possible to consider the loop-functional approach to some particular types of nonlinearities. For instance, [293, 306] propose an extension of Theorem 3.2 to linear systems subject to input saturations.

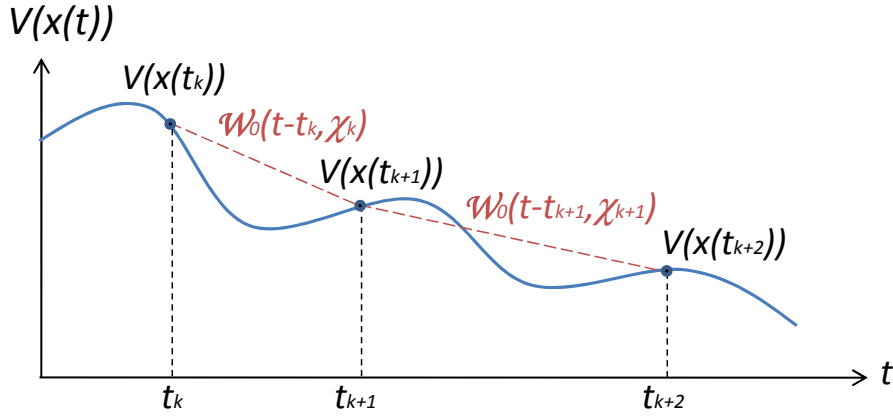

Figure 3.4: Illustration of Theorem 3.2 with $\mathcal{V}_0(T_k, \chi_k) = \mathcal{V}_0(0, \chi_k) = 0$.

Remark 3.2

It is important to note that the functional \mathcal{V}_0 has for argument function χ_k considered over the whole interval $[0, T_k]$. In particular, functional \mathcal{V}_0 , which was considered in the previous proof depends on $\chi_k(T_k) = x(t_{k+1})$. In a classical Lyapunov approach, such a term is prohibited because of causality since it represents the future of the current state $x(t)$. Therefore, this framework of loop functional allows one to consider a wider class of functionals than usually permitted using the input delay approach together with the Lyapunov-Krasovskii theorem.

A graphical illustration of the proof of Theorem 3.2 is shown in Figure 3.4. This illustration helps to understand this equivalence by noting that if $V(x(t_k))$ is greater than $V(x(t_{k+1}))$, then there exists a continuous strictly decreasing function of time starting from $V(x(t_k))$ at time $t = t_k$, and reaching $V(x(t_{k+1}))$ at time $t = t_{k+1}$. Theorem 3.2 provides the theoretical framework to use such simple considerations when assessing stability of a linear sampled-data system.

3.4.3 What is a good structure for a looped functional?

Looped-functionals inspired by the input delay and impulsive system approaches

After presenting the main result of this section, the next natural question is to find good candidates for looped-functionals. It is a priori not clear how to construct such functionals, which satisfy the looping condition (3.19). The one presented in the proof of Theorem 3.2 is not helpful since it leads to the equivalent Lyapunov condition resulting from the discretized model of the sampled-data system, since the conditions $\Delta_0 V(k) < 0$ leads exactly to Lemma 3.1-(iv). Therefore, selecting this particular functional does not bring much for assessing asymptotic stability of sampled-data systems compared to Lemma 3.1-(iv).

On the other side, one may be inspired by the Lyapunov-Krasovskii functionals considered with the input-delay approach. For instance in [100, 188, 189, 277, 278], functionals issued from the impulsive systems modeling presented in [220, 219]. These Lyapunov-Krasovskii functionals can be

presented in the following form

$$V_d(x_t, \dot{x}_t) = x^\top(t)Px(t) + (t_{k+1} - t)(x(t) - x(t_k))^\top (S_1(x(t) - x(t_k)) + 2S_2x(t_k)) \\ + (t_{k+1} - t) \int_{t_k}^t \dot{x}^\top(s)Z\dot{x}(s)ds, \quad \forall t \in [t_k, t_{k+1}),$$

for some matrices $P = P^\top$, $S_1 = S_1^\top$, S_2 and $R = R^\top$ of appropriate dimension. In [100, 188, 189, 277, 278], the positive definiteness of the functional V_d is required in order to apply the Lyapunov-Krasovskii theorem. However, it is worth noting that such a functional has jumps at the sampling instants and even if it is continuous, the functional is not differentiable at the sampling instants. Nevertheless, the methodology developed in [100], allows guaranteeing asymptotic or exponential stability of sampled-data systems.

Inspired from this functional, one may rephrase this analysis in light of the looped functional approach. Indeed, functional V_d is composed of four terms, whose first, $x^\top(t)Px(t)$, can be considered as the Lyapunov function V in (3.18). It remains to show that the last terms can also be reformulated in the framework of Theorem 3.2. To do so, let us consider the following functional expressed using the shifted state function χ_k and defined a functional \mathcal{V}_{0d} given by

$$\mathcal{V}_{0d}(\tau, \chi_k) = (T_k - \tau)(\chi_k(\tau) - \chi_k(0))^\top (S_1(\chi_k(\tau) - \chi_k(0)) + 2S_2\chi_k(0)) \\ + (T_k - \tau) \int_0^\tau \dot{\chi}_k^\top(s)Z\dot{\chi}_k(s)ds + (T_k - \tau)\tau\chi_k^\top(0)X\chi_k(0), \quad \forall \tau \in [0, T_k).$$

First, an additional term, which depends on matrix $X = X^\top \in \mathbb{R}^{n \times n}$ has been included. It is easy to see that such a functional verify the looping condition (3.19), since we trivially have $\mathcal{V}_{0d}(0, \chi_k) = \mathcal{V}_{0d}(T_k, \chi_k) = 0$. Hence, the function \mathcal{V}_{0d} can be employed together with the quadratic Lyapunov function $V(x) = x^\top Px$. This leads to the following theorem presented in [280].

Theorem 3.3

Let $0 < \mathcal{T}_1 \leq \mathcal{T}_2$ be two positive scalars. Assume that there exist $n \times n$ symmetric matrices $P > 0$, $R > 0$, S_1 and X in \mathbb{S}^n and matrices $S_2 \in \mathbb{R}^{n \times n}$ and $N \in \mathbb{R}^{2n \times n}$ that satisfy

$$\forall i = 1, 2, \quad \Psi_0^1(\mathcal{T}_i) = \Pi_1 + \mathcal{T}_i(\Pi_2 + \Pi_3) < 0, \\ \Psi_0^2(\mathcal{T}_i) = \begin{bmatrix} \Pi_1 - \mathcal{T}_i\Pi_3 & \mathcal{T}_i N \\ * & -\mathcal{T}_i R \end{bmatrix} < 0, \quad (3.21)$$

where

$$\Pi_1 = \text{He}\{M_1^\top P M_0 - M_{12}^\top (\frac{1}{2}S_1 M_{12} + S_2 M_2 + N^\top)\} \\ \Pi_2 = M_0^\top R M_0 + \text{He}\{M_0^\top (S_1 M_{12} + S_2 M_2)\}, \\ \Pi_3 = M_2^\top X M_2, \quad (3.22)$$

with $M_0 = [A \ BK]$, $M_1 = [I \ 0]$, $M_2 = [0 \ I]$ and $M_{12} = M_1 - M_2$.

Then the system (3.3) is asymptotically stable for any sampling sequence $\{t_k\}_{k \geq 0}$ satisfying (3.1). and, the inequality

$$\Lambda^\top(A, B, K, T)P\Lambda(A, B, K, T) - P < 0 \quad (3.23)$$

holds for all T in $[\mathcal{T}_1, \mathcal{T}_2]$.

Proof: The proof is not detailed in this manuscript but can be found in [280]. \diamond

This previous theorem have several advantages over existing results from the literature, which are described in the following list.

- A conclusion of this theorem is directly related to the Lyapunov stability condition based on the discretized model (3.4) presented in the fourth item of Lemma 3.1. Indeed, inequality (3.23) is guaranteed for any $T \in [\mathcal{T}_1, \mathcal{T}_2]$ without having computed the exponential matrix $\Lambda(A, B, K, T)$. This issue was never pointed out so clearly in the literature of sampled-data systems using the input delay approach.
- Using the Schur Complement on the first term of Π_2 , one can see that both conditions in (3.21) are convex in the system matrices A and B . Therefore, a trivial extension of Theorem 3.3 leads to robust stability conditions with parameter uncertainties. A notable consequence is that inequality (3.23) is still guaranteed for any $T \in [\mathcal{T}_1, \mathcal{T}_2]$ and for any matrices $[A \ B] \in \mathcal{C}o_{i=1, \dots, m} \{[A_i \ B_i]\}$, where matrices A_i and B_i , $i = 1, \dots, m$, $m > 0$ defines the polytopic uncertainties, without having computed the exponential matrix $\Lambda(A, B, K, T)$. This can be seen as the major advantages of the stability analysis based on the discretized model as for instance in [79, 154, 198]
- As mentioned previously, the looped-functional framework allows us to relax some positivity constraints on the selection of functionals compared to usual the Lyapunov-Krasovskii functionals. This relaxation leads to remarkable numerical results. For the sake of simplicity, no numerical results will be presented in this chapter. Note however that Theorem 3.3 assess stability of the particular sampled-data system (3.6), while the input delay approach does not.

Despite the potential relaxation with respect to the application of the Lyapunov-Krasovskii theorem, the previous theorem has a major drawback. One can notice that Theorem 3.2 presents an equivalence between a discrete and a continuous-time stability conditions for sampled-data systems. It is important to state that Theorem 3.3 only exposes sufficient stability conditions. The reason why the necessity part is broken comes from the selection of the looped-functional \mathcal{V}_{0d} inspired from the input delay and the impulsive systems approaches. In order to refine the stability conditions, one may look at enriched version of \mathcal{V}_{0d} , which could for instance take benefits of

- using less conservative integral inequality as in [296], with Wirtinger-based integral inequality;
- including a fragmentation of the sampling interval as in [46];
- or including more information on the shifted state function χ_k as in [355], where the functional include $\chi_k(T_K)$ as well.

Polynomial looped functionals

In the statement of Theorem 3.2, no particular structure for the looped-functional has been specified. It is then possible to construct them without following the structures inspired by the input-delay approach from [105, 100], or the impulsive systems approach [219]. To do so, I have contacted M.M Peet, a researcher known for his researcher on time-delay systems using the Sum of Squares (SOS) framework. Together we have proposed a new structure for looped-functional based on a polynomial formulation. The basic idea consists in defining a symmetric polynomial matrix M in \mathbb{S}^{2n} such that a new looped functional is given by

$$\mathcal{V}_{0p}(\tau, T_k, \chi_k) = \begin{bmatrix} \chi_k(\tau) \\ \chi_k(0) \end{bmatrix}^\top M(\tau, T_k) \begin{bmatrix} \chi_k(\tau) \\ \chi_k(0) \end{bmatrix}. \quad (3.24)$$

In this setup, M is a bi-polynomial matrix in $\tau \in [0, T_k]$ and in $T_k \in [\mathcal{T}_1, \mathcal{T}_2]$, of arbitrary degree. This polynomial formulation leads to the following result presented in [308, 309].

Theorem 3.4

For given $0 \leq \mathcal{T}_1 < \mathcal{T}_2 < \infty$, if there exist $P \in \mathbb{S}^n$, positive definite and a bi-polynomial matrix $M : [0, \mathcal{T}_2] \times [\mathcal{T}_1, \mathcal{T}_2] \rightarrow \mathbb{S}^{2n}$ such that for all $T \in [\mathcal{T}_1, \mathcal{T}_2]$,

$$P \succ 0, \quad \begin{bmatrix} I \\ I \end{bmatrix}^T M(0, T) \begin{bmatrix} I \\ I \end{bmatrix} = 0, \quad M(T, T) = 0, \quad (3.25)$$

and such that the following inequality holds for all $\tau \in [0, T]$ and all $T \in [\mathcal{T}_1, \mathcal{T}_2]$

$$\bar{\Psi}(\tau, T) = He \left\{ \left(\begin{bmatrix} P & 0 \\ 0 & 0 \end{bmatrix} + M(\tau, T) \right) \begin{bmatrix} A & BK \\ 0 & 0 \end{bmatrix} \right\} + \frac{d}{d\tau} M(\tau, T) \prec 0. \quad (3.26)$$

Then, sampled-data system (3.3) is asymptotically stable for any sampling sequence $\{t_k\}_{k \geq 0}$ satisfying (3.1) and moreover, the condition

$$\Lambda^\top(A, B, K, T) P \Gamma(A, B, K, T) - P \prec 0$$

holds for all $T \in [\mathcal{T}_1, \mathcal{T}_2]$.

Proof: The proof can be found in [303] and is therefore omitted in this manuscript. \diamond

At a first sight, conditions (3.25) and (3.26) are more elegant and simpler than the one presented in Theorem 3.3. Indeed the complexity of the structure of the looped-functional is hidden in the bi-polynomial matrix M . That being said, the complexity of Theorem 3.4 still exists and arises when one wants to evaluate the inequality on numerical software. This method requires the use of the Sum of Squares framework in an SDP formulation [245, 255, 324], which requires a careful attention.

3.5 Extensions and an emphasis to networked control systems

In this section, a brief overview of the contributions extensions of the looped-functional approach is presented. A more detail focus on an application of sampled-data dynamic output feedback controller taken from [121] is presented to illustrate the potential of the method.

3.5.1 A brief overview of the latter achievements

The looped-functional approach presents a relevant alternative to assess asymptotic or exponential stability of sampled-data systems compared to the discretization, the input-delay or the impulsive systems approaches. It notably puts forward the existing links between those three existing approaches. Several extensions have been provided in the literature. One can first mention that Theorem 3.4 has been revisited in order to provided exponential stability with guaranteed decay rate in [280, 309]. Some possible extensions to the case of sampled-data systems subject to additional continuous-time delay were proposed in [160, 161, 279]. These contributions give an alternative solution for assessing stability of linear systems subject to the sawtooth delay functions presented in Figure 3.3.

This method also has the advantage to be applicable to a wider class of systems than the sole sampled-data systems. As it was pointed out earlier in this chapter, sampled-data systems represents a particular class of impulsive systems [219]. Indeed, sampled-data system (3.3) can be rewritten as the extended impulsive system, which follows the hybrid dynamics

$$\begin{cases} \frac{d}{dt} \begin{bmatrix} x \\ z \end{bmatrix} = \begin{bmatrix} A & B \\ 0 & 0 \end{bmatrix} \begin{bmatrix} x \\ z \end{bmatrix}, & t \notin \{t_k\}_{k \geq 0} \\ \begin{bmatrix} x \\ z \end{bmatrix}^+ = \begin{bmatrix} I & 0 \\ K & 0 \end{bmatrix} \begin{bmatrix} x \\ z \end{bmatrix}, & t \in \{t_k\}_{k \geq 0} \end{cases} \quad (3.27)$$

Impulsive system (3.27) involves a new state variable z , which is introduced to model the held value of the control input Kx at the last jump instant. Indeed since $\dot{z} = 0$ during the inter-sampling interval, variable z stay still until the next sampling instant. System (3.27) finally corresponds to a particular class of impulsive systems where the impulse instants only depends on time. This class of system may be represented by the following dynamics

$$\begin{cases} \dot{X} = \mathcal{A}X, & t \notin \{t_k\}_{k \geq 0}, \\ X^+ = \mathcal{J}X, & t \in \{t_k\}_{k \geq 0}. \end{cases} \quad (3.28)$$

Impulsive systems has been widely considered in the literature, which occur in several fields like epidemiology [51, 323] and sampled-data control as considered previously in this chapter.. The reader may refer for instance to [22, 54, 55, 118, 119, 152, 346]. We have shown, with Corentin Briat, that the looped-functional approach also applies to this class of systems. More particularly, looped-functional inspired from the input delay approach has been proposed in [48]. Alternatively, polynomial-type of looped-functionals were considered in [47]. The remarkable aspect of these two contributions relies on the possibility to provide robust stability conditions with respect to aperiodic impulse instants as well as with respect to uncertainties in both matrices \mathcal{A} and \mathcal{J} . They are also able to provide numerically good estimations of minimal and/or maximal dwell times. This method was also extended to the case of switched systems in [49], and to pseudo-periodic systems in [281, 50].

Another interesting potential of the impulsive system approach is to possibility to model sampled-data systems subject to input delays using a different philosophy compared to previous work related to the input delay approach, where the resulting delayed and sampled input is usually presented as $x(t_k - h)$. In [282, 283, 281], we have used this impulsive system representation in order to assess stability of linear (and possibly uncertain) aperiodic sampled-data systems subject to a so-called *incremental delay* h , whose dynamics follows:

$$\dot{x}(t) = Ax(t) + BKx(t_{k-h}), \quad \forall t \in [t_k, t_{k+1}), k \in \mathbb{N}.$$

where h is a positive integer. An interesting contribution was presented in [282, 283], where usual Lyapunov-Krasovskii functional for discrete-time systems, to account for the incremental delay h has been mixed to a looped-functional to the sampled-data nature of this system.

The question of conservatism of looped-functionals was already discussed earlier in this chapter. The equivalence between the discrete and continuous-time stability conditions is broken as soon as a looped-functional is selected a priori. In [50], it was proven that polynomial-type of looped functional, as presented in Theorem 3.4 for sampled-data systems, or more generally to impulsive systems (3.28) are asymptotically non conservative. In other words, increasing the degree of the bi-polynomial matrix M (or Z in [50]), reduces the conservatism and makes the resulting stability condition converge eventually to a non conservative condition.

Following the formalism of hybrid dynamical systems [118, 119], sampled-data system (3.3) can be rewritten as the extended hybrid dynamical system, which follows the hybrid dynamics

$$\begin{cases} \dot{x} &= Ax + Bz, \\ \dot{z} &= 0, \\ \dot{\tau} &= 1, \\ \dot{T} &= 0, \end{cases} \quad (x, z, \tau, T) \in \mathcal{C} = \{(x, z, \tau, T) \in \mathbb{R}^{2n+2}, \tau \leq T\}$$

$$\begin{cases} x^+ &= x, \\ z^+ &= Kx, \\ \tau^+ &= 0, \\ T^+ &\in [\mathcal{T}_1, \mathcal{T}_2], \end{cases} \quad (x, z, \tau, T) \in \mathcal{D} = \{(x, z, \tau, T) \in \mathbb{R}^{2n+2}, \tau \geq T\}$$
(3.29)

The first four equations represent the evolution of the systems when flowing, i.e. a continuous-time evolution of the system, while the last four equations corresponds to discrete dynamics appearing during jump. The sets \mathcal{C} and \mathcal{D} are called flow and jump sets, respectively. Again, variable z has been introduced to model the held value of the control input Kx at the last jump instant.

In this formulation, τ and T appear as variables of hybrid dynamical system and τ increases as time during flows and is reset to zero during jumps. It represents a timer that measures the time elapsed since the last jump. From the general Lyapunov theorem provided in [119], a Lyapunov function for hybrid system (3.29) should depend on all the state variables, including, the timer τ and the inter-sampling time T . In [41, 44], such a Lyapunov function was considered and has the following form

$$V_H(x, z, \tau, T) = \begin{bmatrix} x \\ z \end{bmatrix}^\top P(\tau, T) \begin{bmatrix} x \\ z \end{bmatrix},$$

where P is a symmetric positive definite matrix function, from $[0, \mathcal{T}_2] \times [\mathcal{T}_1, \mathcal{T}_2]$ to \mathbb{S}^{n+m} . Such Lyapunov function is called clock-dependent function. The equivalence between this Lyapunov function and the looped-functional approaches was demonstrated in [42] from a theoretical point of view. It was also mentioned therein that the clock-dependent Lyapunov approach is more efficient from the numerical point of view, since it involves less decision variables. Several contributions in this direction have been provided by several researchers in [41, 43, 44, 117, 322] and the references therein.

3.5.2 Application to sampled-data dynamic output-feedback control under input saturations

Problem formulation:

The motivations of this section is to illustrate the potential of the use of looped-functional in a more complicated situation than the stability problem of a linear systems controller by a sampled-data static state feedback. This section presents the main features of our contribution in [121] where we consider the continuous-time linear plant with saturating inputs described by:

$$\begin{cases} \dot{x}_p(t) &= A_p x_p(t) + B_p \text{sat}(\bar{u}(t)), \\ y(t) &= C_p x_p(t). \end{cases} \quad (3.30)$$

where $x_p \in \mathbb{R}^{n_p}$, $\bar{u} \in \mathbb{R}^m$ and $y \in \mathbb{R}^p$ represent the state, the input and the output vectors of the plant, respectively. Matrices A_p , B_p , C_p have appropriate dimensions and are supposed to be constant. We

assume that the control inputs are sampled possibly in an aperiodic manner and the value of \bar{u} is kept constant (through a zero-order hold) between two successive sampling instants i.e.:

$$\bar{u}(t) = u(t_k), \quad \forall t \in [t_k, t_{k+1}). \quad (3.31)$$

The sequence of sampling instants $\{t_k\}_{k \geq 0}$ verifies (3.1). For output feedback purposes, we consider that the output $y(t)$ is sampled at the same instants of the control input, i.e. at each sampling instant t_k , sampled $y(t_k)$ is generated. Considering a digital implementation, we assume that system (3.30) is controlled by a linear discrete-time dynamic output feedback controller, described in state space as follows:

$$\begin{aligned} x_c(t_{k+1}) &= A_c x_c(t_k) + B_c y(t_k) + E_c \psi(u(t_k)), \\ u(t_k) &= C_c x_c(t_k) + D_c y(t_k), \end{aligned} \quad (3.32)$$

where $x_c \in \mathbb{R}^{n_c}$, $y \in \mathbb{R}^p$ and $u \in \mathbb{R}^m$ are the state, the input and the output of the controller, respectively. The matrices A_c , B_c , C_c , D_c , E_c are assumed to be constant and of appropriate dimensions. $\psi(u)$ is a vector-valued decentralized deadzone nonlinearity defined as follows:

$$\psi(u) = \text{sat}(u) - u. \quad (3.33)$$

The term $E_c \psi(u)$ regards a static anti-windup compensation, which can be appended to the controller to mitigate the saturation effects on performance and stability [125], [126]. In this case, at each sampling instant, the plant output is sampled and its value is used to instantaneously update both the controller state and the control input to be applied to the plant between in the interval $[t_k, t_{k+1})$. It should be noticed that the method used to design the controller (3.32) is out of the scope of the present work. Our main goal is to provide a method to assess the stability of the sampled-data closed-loop system defined by the connection between this controller and the continuous plant (3.30). On the other hand, it is reasonable (and relevant from a practical point of view) to assume that (3.32) has been designed considering classical techniques based on the discretization of a continuous dynamic output feedback or on a periodic sampling paradigm, i.e. with $T_k = \delta$, $\forall k$, and then to analyze the effects on stability of a possibly aperiodic sampling policy with $T_k \in [\mathcal{T}_1, \mathcal{T}_2]$. In this case, we can assume for instance that matrices A_c , B_c , C_c , D_c , E_c , have been designed considering one of the two approaches below

1. *Discrete-time design.* First, an exact discretization of the plant should be performed. Considering $t_{k+1} - t_k = \delta$, $\forall k$, this leads to the following discrete-time model:

$$\begin{aligned} x_p(t_{k+1}) &= A_{p,d} x_p(t_k) + B_{p,d} \text{sat}(u(t_k)), \\ y(t_k) &= C_{p,d} x_p(t_k) \end{aligned} \quad (3.34)$$

with $A_{p,d} = e^{A_p \delta}$, $C_{p,d} = C_p$, $B_{p,d} = \int_0^\delta e^{A_p(\delta-s)} ds B_p$. Thus, based on model (3.34), known discrete-time results can be applied to design matrices A_c , B_c , C_c and E_c in order to stabilize (considering periodic sampling) the closed-loop system.

2. *Controller discretization.* First, a continuous-time stabilizing controller, described by

$$\begin{aligned} \dot{x}_c(t) &= \bar{A}_c x_c(t) + \bar{B}_c y(t) + \bar{E}_c \psi(u(t)), \\ u(t) &= \bar{C}_c x_c(t) + \bar{D}_c y(t), \end{aligned} \quad (3.35)$$

is designed considering the continuous-time plant model (3.30). Then, assuming a periodic sampling, a discretization of this controller can be performed using classical Euler or Tustin

approximations. Alternatively, a discrete-time approximation ensuring that the value of the output of the continuous and the discrete-time controllers coincide at the sampling instants $t_k = k\delta$ can be considered. This leads to a discrete-time controller as in (3.32) with:

$$A_c = e^{\bar{A}_c\delta}, \quad C_c = \bar{C}_c, \quad D_c = \bar{D}_c, \quad B_c = \int_0^\delta e^{\bar{A}_c(\delta-s)} ds \bar{B}_c, \quad E_c = \int_0^\delta e^{\bar{A}_c(\delta-s)} ds \bar{E}_c \quad (3.36)$$

Stability analysis based on looped-functionals

Due to the hybrid nature of the whole interconnected system composed of a linear plant with saturated input (3.30) and of a discrete-time dynamic output feedback (3.32), a dedicated analysis is required. Following the methodology of looped functionals together with the lifted state $\chi_k(\tau) = x(t_k + \tau)$ where $x^\top(t) = [x_p^\top(t) \ x_c^\top(t)]$, the following regional stability theorem is provided.

Theorem 3.5

For given positive scalars $\mathcal{T}_1 \leq \mathcal{T}_2$, assume that there exist symmetric positive definite matrices P, R , symmetric matrices X, S_1 , a diagonal positive definite matrix U , matrices G, V, S_2 and N of appropriate dimensions and a positive scalar α , that satisfy, for $i = 1, 2, j = 1, \dots, m$

$$\Psi_1(\mathcal{T}_i) = \begin{bmatrix} \Pi_1 + \mathcal{T}_i(\Pi_3 + \Pi_4) & \mathcal{T}_i N \\ \mathcal{T}_i N' & -\mathcal{T}_i R \end{bmatrix} < 0, \quad (3.37)$$

$$\Psi_2(\mathcal{T}_i) = \Pi_1 + \mathcal{T}_i(\Pi_2 - \Pi_3 + \Pi_4) < 0, \quad (3.38)$$

$$\begin{bmatrix} P + VM_f + M_f'V' & [0 \ K_j - G_j]' \\ [0 \ K_j - G_j] & \alpha u_{0j}^2 \end{bmatrix} > 0, \quad (3.39)$$

with

$$\begin{aligned} \Pi_1 &= M_+'PM_+ - M_-'PM_- + M_{12}'S_1M_{12} - 2M_5'UM_5 \\ &\quad + \text{He}\{M_{12}'S_2M_2 + NM_{12} - M_5'UG \begin{bmatrix} M_3 \\ M_4 \end{bmatrix}\} \\ \Pi_2 &= M_c'RM_c + \text{He}\{M_c'(S_1M_{12} + S_2M_2)\}, \\ \Pi_3 &= \begin{bmatrix} M_2 \\ M_5 \end{bmatrix}' X \begin{bmatrix} M_2 \\ M_5 \end{bmatrix}, \\ \Pi_4 &= \text{He} \left\{ \begin{bmatrix} M_c \\ 0 \\ 0 \end{bmatrix}' P \begin{bmatrix} M_1 \\ M_3 \\ M_4 \end{bmatrix} \right\}, \end{aligned} \quad (3.40)$$

where

$$\begin{aligned} M_1 &= \begin{bmatrix} I & 0 & 0 & 0 & 0 \end{bmatrix}, \quad M_2 = \begin{bmatrix} 0 & I & 0 & 0 & 0 \end{bmatrix}, \\ M_3 &= \begin{bmatrix} 0 & 0 & I & 0 & 0 \end{bmatrix}, \quad M_4 = \begin{bmatrix} 0 & 0 & 0 & I & 0 \end{bmatrix}, \\ M_5 &= \begin{bmatrix} 0 & 0 & 0 & 0 & I \end{bmatrix}, \quad M_{12} = M_1 - M_2, \\ M_+ &= \begin{bmatrix} 0 & I & 0 & 0 & 0 \\ 0 & I & 0 & 0 & 0 \\ 0 & 0 & B_c C_p & A_c & E_c \end{bmatrix}, \quad M_- = \begin{bmatrix} 0 & I & 0 & 0 & 0 \\ 0 & 0 & I & 0 & 0 \\ 0 & 0 & 0 & I & 0 \end{bmatrix}, \end{aligned} \quad (3.41)$$

$$M_f = \begin{bmatrix} I & -I & 0 \end{bmatrix}, \quad M_c = \begin{bmatrix} A_p & 0 & B_p D_c C_p & B_p C_c & B_p \end{bmatrix},$$

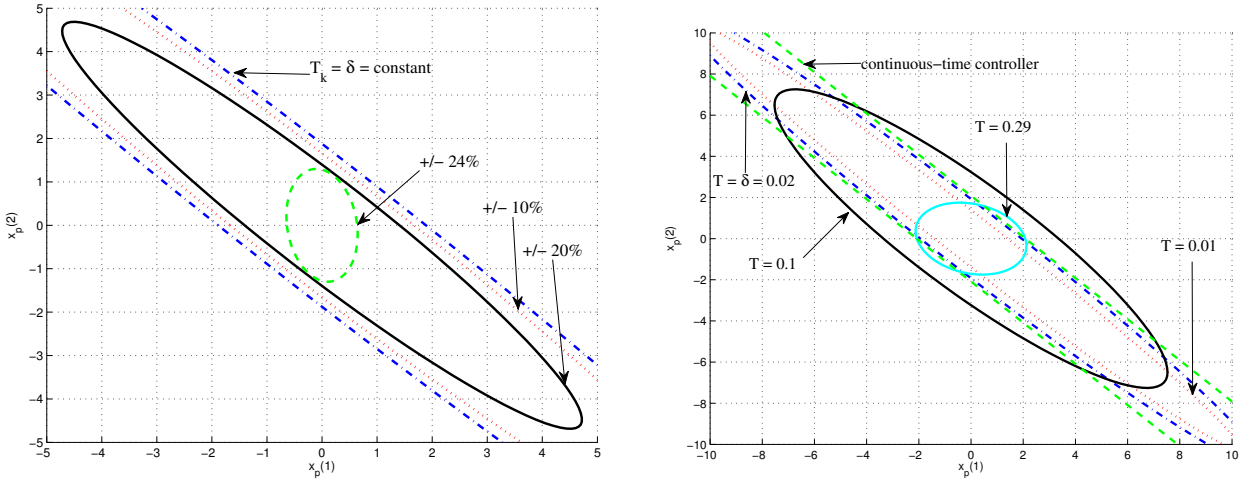

(a) Influence of \mathcal{T}_1 , and \mathcal{T}_2 with $\mathcal{T}_1 = \delta - \mu$ and $\mathcal{T}_2 = \delta + \mu$ on the ellipsoidal regions of stability in the system plane ($x_c = 0$) considering $\delta = 0.02$ and the following cases: $\mu = 0$ (dashed-dotted line), $\mu = 10\% \delta$ (dotted line), $\mu = 20\% \delta$ (solid line) and $\mu = 24\% \delta$ (dashed green line).

(b) Ellipsoidal regions of stability in the system plane ($x_c = 0$). Influence of a periodic sampling T ($\mathcal{T}_1 = \mathcal{T}_2 = T$) when the controller is discretized with $\delta = 0.02$. Cases with $T = \delta = 0.02$ (dashed-dotted line), $T = 0.01$ (dotted line), $T = 0.1$ (solid line) and $T = 0.29$ (solid line). The continuous-time case is plotted in dashed green line.

Figure 3.5: Simulations results

Then, if $\chi_0(0) \in \mathcal{E}(P, \alpha) = \{\chi \in \mathbb{R}^n ; \chi' P \chi \leq \alpha^{-1}\}$, then for any aperiodic sampling satisfying (3.1), $\chi_k(0) \rightarrow 0$ as $k \rightarrow \infty$, i.e. $\mathcal{E}(P, \alpha)$ is a RAS for the closed-loop system (3.30)-(3.32).

Proof: The proof of this theorem can be found in [121] and is therefore ommitted. \diamond

Numerical Example

Let us consider the model of an unstable continuous-time balancing pointer system, expressed as in (3.30) with the following matrices

$$A_p = \begin{bmatrix} -0 & 1 \\ 1 & 0 \end{bmatrix}, B_p = \begin{bmatrix} 0 \\ -1 \end{bmatrix}, C_p = [1 \quad 1]$$

with the saturation level $u_0 = 5$. Note that since A_p is not Hurwitz, in view of the saturation constraint, only local asymptotic stability for the closed-loop system with discrete-time (or continuous-time) control can be guaranteed. We consider a stabilizing continuous-time dynamic controller (3.35), whose matrices are given by ([329], p.312)

$$\bar{A}_c = 0, \bar{B}_c = 10, \bar{C}_c = 1, \bar{D}_c = 2, \bar{E}_c = 0. \quad (3.42)$$

Next, we illustrate the application of our results under different perspectives of analysis.

Influence of δ : Consider a discretized version of the controller obtained from (3.36). Let us first consider the influence of the discretization period δ . With this aim, we apply the conditions of

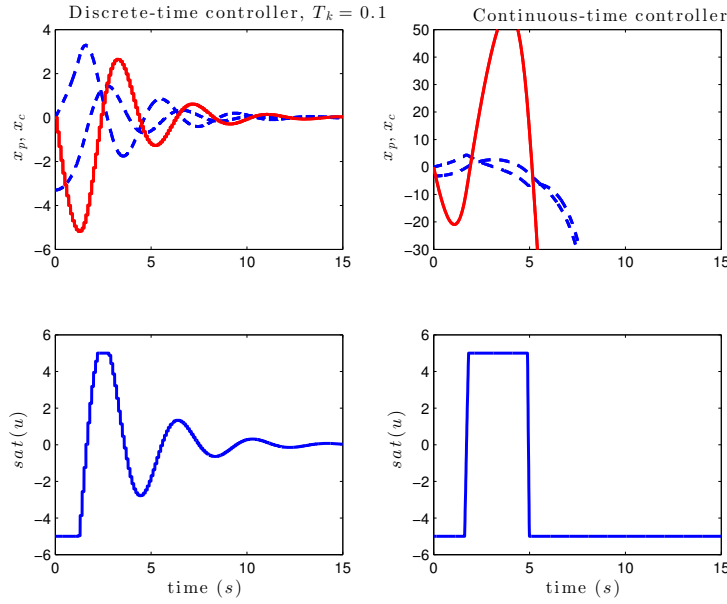

Figure 3.6: Time response of the closed-loop system. Left-hand side: with discretized controller given by matrices in (3.43) and implemented with a periodic sampling $T = 0.1$. Right-hand side: with the continuous-time controller given by matrices in (3.42).

Theorem 1 considering a periodic sampling, i.e. $T_k = \delta = \mathcal{T}_1 = \mathcal{T}_2, \forall k$. It follows that no solution for these conditions can be found for δ larger than $0.08s$.

Robustness with respect to aperiodic sampling: Consider now the discretized version of the controller, obtained from (3.36) with $\delta = 0.02s$, given by:

$$A_c = 1; \quad B_c = 0.2; \quad C_c = 1; \quad D_c = 2. \quad (3.43)$$

We evaluate now what happens under aperiodic sampling. For this we consider an allowable intersampling interval $T_k \in [\mathcal{T}_1, \mathcal{T}_2]$ centered at δ , i.e. $\mathcal{T}_1 = \delta - \mu$ and $\mathcal{T}_2 = \delta + \mu$. Considering Problem P1, the influence of μ on the size of the obtained RAS is shown in Figure 3.5(a). Note that, as expected, the larger is μ (i.e. the larger is the admissible interval $[\mathcal{T}_1, \mathcal{T}_2]$), the smaller tends to be the region of stability $\mathcal{E}(P, \alpha)$. Moreover, the larger region is obtained with $\mu = 0$, which corresponds to the periodic sampling case. Note that conditions (3.37), (3.38), (3.39) become unfeasible when μ becomes larger than $\pm 24\% \delta = \pm 40ms$.

Robust periodic implementation: Consider now the dynamic discrete-time controller with the matrices given in (3.43), but that the actual periodic sampling period is different from $\delta = 0.02s$. In other words, we consider $\mathcal{T}_1 = \mathcal{T}_2 = T \neq 0.02$. It can be observed that conditions (3.37), (3.38) and (3.39) remain feasible when reducing the sampling T much below 0.02, although the size of the stability domain is significantly degraded. Actually this domain shrinks as T decreases from 0.02. On the other hand, when T is increased above the value of 0.02, the problem remains feasible until $T = 0.29$. This is illustrated in Figure 3.5(b) where it can be observed the influence of the sampling period T on the size of the stability domain. For comparison purposes, the RAS obtained (from the application of Proposition 3.1 in [329]) considering the continuous-time implementation of the controller is also depicted in the figure.

An interesting aspect of this evaluation is that, with $T = \mathcal{T}_1 = \mathcal{T}_2$ larger than δ , initial conditions

not belonging to the region of attraction corresponding to the continuous-time closed-loop system (i.e. obtained from the connection between (3.30) and (3.35) with $\bar{u}(t) = u(t)$) belong to the region of attraction obtained with the discrete-time implementation of the controller. This is illustrated in Figure 3.6, which compares the time evolution of the closed-loop system with the discrete-time controller (3.43) implemented with $T = 0.1$ and that one with the PI continuous-time controller (3.42), for the initial condition $x_p(0) = \begin{bmatrix} -3.3 \\ 0 \end{bmatrix}$, $x_c(0) = 0$. In fact, this initial condition belongs to the RAS obtained for the discrete-time controller, but does not belong to the one associated to the continuous-time implementation.

3.6 Conclusions

In this chapter, after a brief presentation of the main motivations and difficulties, two different approaches to assess stability of sampled-data systems was presented. The first approach concerns the modeling of sampled-and-hold signal as a continuous functions affected by a sawtooth delay. Following the same principle and procedure of the design of Lyapunov-Krasovskii functionals as the ones presented in Chapter 2, an example of stability theorems based on the application of the Lyapunov-Krasovskii theorem has been presented. Compared to the previous chapter, an emphasis on the time-varying delay case has been provided. The advantages and drawbacks of this method has also been discussed. The second method, which relies on the looped-functional theorem presents an efficient alternative with respect to the first approach. It notably allows to relax some constraints on the selection of the functionals. Several extensions to impulsive, switched systems have been pointed out. Finally, an example of problems that can be treated using the looped-functionals framework has been provided and demonstrates the potential of the approach. Several perspectives of these contributions will be exposed in Chapter 4.

Chapter 4

Conclusions and Perspectives

Contents

4.1	General conclusion	76
4.2	Further results on sampled-data systems	77
4.2.1	Robust sampled-data control	77
4.2.2	Event-triggered sampled-data control	78
4.3	Stability analysis and control of time-delay systems	82
4.3.1	Stability analysis of time-delay systems	82
4.3.2	Emphasis on time-varying delay systems	82
4.3.3	Stabilization and control of time-delay systems	84
4.3.4	Finite dimensional controllers and observers for time-delay systems	84
4.4	Stability and control of infinite dimensional systems	86
4.4.1	Stability of coupled linear ODE-PDE systems	87
4.4.2	Stabilisation of PDE systems and backstepping methods	89
4.4.3	Sampled-data and event-based control of PDE	90

4.1 General conclusion

In the previous chapters, a resume of the contributions I have developed during my PhD, post-doc at Leicester in England and at KTH in Sweden and later as a CNRS Researcher in France both at GIPSA-Lab, Grenoble and at LAAS, Toulouse, has been presented. These contributions cover a large range of applications from the fields of Networked Control Systems with an emphasis on time-delay and sampled-data systems, but also on multi-agents systems and distributed control. The main achievements are related to time-delay systems and sampled-data systems. As detailed in Chapters 2 and 3, my main contributions are related to the considerations of integral inequality as the main theoretical tool for the stability analysis of time-delay systems. Indeed Wirtinger-based integral inequality and the Bessel-Legendre inequality have brought a new sight and a second breeze to the field, according the number of papers that have been produced since 2013. On the other hand, the input delay and the looped-functionals approaches represent efficient theoretical tools to address stability problems for sampled-data systems and have conducted to researches performed by several researchers of the field. There are several aspects I would like to consider for my future researches. The basics of my perspectives are obviously strongly related to my previous achievements with the view of applying these methodologies to a wider class of systems. These perspectives presented in this chapter are concerned with Cyber-Physical Systems.

Cyber-physical systems represents a wild class of systems which are composed, on one side, of the interconnection between one or several physical plants and, on the other side, one or several digital components evolving in different time scales or frequency [341, 21] Since the dawn of the microprocessor era in the 1970s, embedded computers have been designed into many system types, but developers have done this work mostly with spit and baling wire. Surprisingly, only small amount of theory tells us how to design computer-based control systems. Cyber-physical systems theory attempts to correct this deficiency.

The perspectives aim at addressing various classes of problems related to cyber-physical systems. More particularly, a focus is proposed on the the class of interconnected systems of heterogenous nature. The “cyber” part, which refers control part, invokes the dynamics of algorithms implemented on computer, chips etc... and, hence, must be tractable. Among possible dynamics, their are represented by ordinary differential equations. On the other hand, the “physical” parts might be more complicated. Their dynamics results from physical laws that are or can not be necessarily represented as ordinary differential equations but can also include some dynamics that are described by partial differential equations. One of the most simple example of such behavior is related to networked control systems, where, even if the physical part can be modeled by an ordinary differential equations, the presence of delays, resulting from a transport partial differential equations, prevent from the use of a sole ordinary differential equation to model the overall cyber-physical systems. This is not the only example where the heterogeneity in the cyber-physical systems arises. There are many applications where the physics of the systems leads to more complicated systems where the dynamics are described by more general hyperbolic or parabolic equations (see [69, 70, 75, 104, 179, 178, 203, 254, 336] among many others).

This last chapter develops several perspectives to the contributions presented in this manuscript, which have been organized as follows.

- 1) *Further results on sampled-data systems*
- 2) *Stability analysis, control and observation of time-delay systems*
- 3) *Stability analysis and control of linear infinite dimensional systems*

The perspectives related to each of these items will be developed in the next sections.

4.2 Further results on sampled-data systems

4.2.1 Robust sampled-data control

In Chapter 3, several contributions have been provided in the case of asynchronous or aperiodic samplings. These contributions can be seen as a robust analysis of linear systems with respect to the effect of samplings and samplings variations. In this context, the samplings instants only depend on time, meaning that an external operator fixed the sampling and the question is to guarantee robust stability with respect to the effect of the sampled-and-hold signals. In this direction, there are still several open problems that I would like to consider in future works.

While the stability analysis has been widely considered in the literature using many techniques, such as the study of the discretized systems [198, 79, 148], or based on lifting methods, input-delay systems [105, 100, 101, 277], the impulsive systems [218, 219], the looped-functionals [280, 48, 355, 309], clock-dependent systems [42, 45, 117], or robust analysis [209, 208, 227, 113]. The reader may look at the recent survey paper [155], which draws a picture of the current activities in the domain of sampled-data systems. Some theoretical links among the previous methods have been already noticed in the literature (see for instance between [209] and [190], [100] and [280] and [309] and [42]). From my point of view, the main methods to assess stability of a sampled-data has been established. However, there are still some open problem and relevant challenges to be faced in the near future.

Sampled-data and delayed control input:

Can we find an efficient method to address the problem of sampled-data systems subject to an additional input delay?

We have shown in Chapter 3 two methods to address robust stability of systems with a sampled-data input. The input delay approach allows straightforwardly to provide stability in the case of both input delay and sampled-data effect in the control input. However, as mentioned in Chapter 3, the input delay approach is conservative since it also assesses stability for any kind of bounded delay functions. To be more accurate, one has to include constraints such as $\hat{\tau} = 1$ in order to refine the stability conditions as done for instance in the looped-functionals approach in [160, 283]. Nevertheless this extension is limited and is not able to capture an unexpected phenomena related to this field. Indeed, for some systems, the maximal allowable sampling is obtained, in simulation, when the input delay is not zero. In other

words, increasing or introducing an input delay to a sampled-data system may help to increase the maximal allowable sampling period. Several directions to tackle this problem are envisioned. First, we may extend the stability conditions of [160] in light of the Wirtinger-based integral or Bessel-Legendre inequalities. Second, one may look at a formulation of this class of systems in the framework of hybrid dynamical systems [118, 119] as briefly introduced in Chapter 3 or in the next section. One may also look at an ODE-PDE formulation, which will be detailed later on in this chapter.

From Stability to Control design:

Can this methodology be applicable to obtain constructive stabilization conditions allowing then to provide optimal control gains with respect to a predefined objective?

There already exist stability conditions issued from the input delay or the looped-functional approaches that can be modified and turned out to constructive stability conditions. The reader may refer to [292, 285, 276, 278] for the input delay approach and [293, 306] for the looped functional methods. For these two methods, the modification of stability conditions to constructive stability conditions requires to perform some manipulations imposing some additional constraints among the decision variable. Consequently additional conservatism is necessarily introduced to solve the problem. There exists however a less conservative method provided in some recent works based on clock-dependent Lyapunov function. Indeed, the method developed in [43, 45] provides a non conservative stabilization condition with respect to the stability version.

Most of the design methods for aperiodic sampled-data systems addresses the state feedback control case. The design of dynamic output feedback control is, to the best of my knowledge, still an open problem. There are two main situations. The first one consists in a dynamic output feedback controller that evolves in continuous time. The second, instead, would consider a dynamic output feedback that is constant during the sampling interval and is only updated at the sampling instants as in [120, 121] and as presented at the end of the previous chapter. This second case represents a relevant problem, both from the technical and practical point of view. From the practical point of view, dynamic output feedback and more generally control algorithms are embedded on digital processors with potentially limited computational power, and limited frequencies. This implies the discretization of control algorithms, which may lead to a deterioration of performance of the closed-loop system. While fully continuous or fully discrete cases have been studied in the literature, the mixed situation has not been regarded to much in the literature, as far as I know. From the applicative point of view, this framework might be also useful in the context of the control of power converters (see for instance [3]).

4.2.2 Event-triggered sampled-data control

In the Chapter 3 on sampled-data systems, an hybrid dynamical system modeling of sampled-data systems was briefly presented. Let us recall that a time-driven sampled-data systems as presented, in

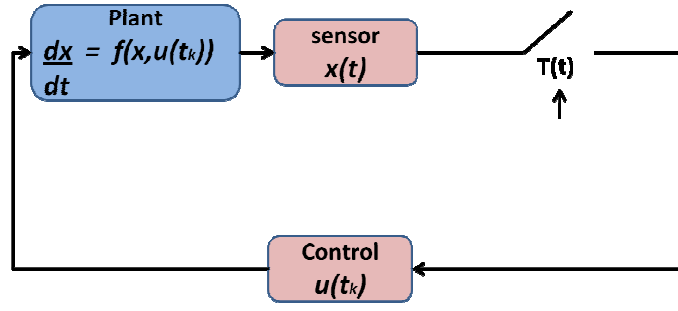

(a) Time-triggered sampling

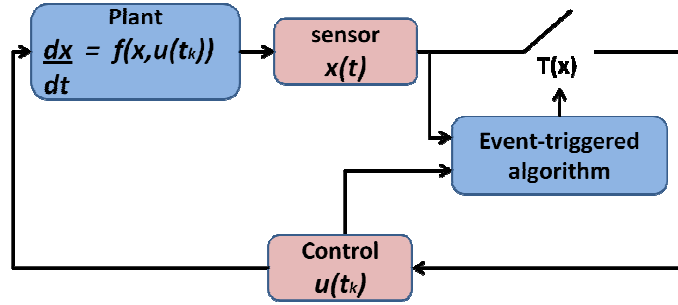

(b) Event-triggered sampling

Figure 4.1: Sampled-data implementation.

the previous chapter, can be rewritten as follows.

$$\begin{cases} \dot{x} &= Ax + Bz, \\ \dot{z} &= 0, \\ \dot{\tau} &= 1, \\ \dot{T} &= 0, \end{cases} \quad (x, z, \tau, T) \in \mathcal{C} = \{(x, z, \tau, T) \in \mathbb{R}^{n+m+2}, \tau \leq T\}$$

(4.1)

$$\begin{cases} x^+ &= x, \\ z^+ &= Kx, \\ \tau^+ &= 0, \\ T^+ &\in [\mathcal{T}_1, \mathcal{T}_2], \end{cases} \quad (x, z, \tau, T) \in \mathcal{D} = \{(x, z, \tau, T) \in \mathbb{R}^{n+m+2}, \tau \geq T\}$$

In this model, the flow and jump sets only depend on the timer τ and on the length of the sampling interval T , corresponding to the sampled-data implementation depicted in Figure 4.1a). This makes that the sampling *clock-dependent* or *time-driven*. In this situation, as demonstrated in the previous chapter, the sampling is seen as a perturbation to a nominal system. The objectives are then to assess robust stability of this perturbed system. However one may also consider another solution referring to *event-triggered* or *event-driven* sampled-data systems. This particular class of sampled-data systems has been investigated in the late 90's in [17] but revisited lately in [18, 7, 9, 210, 327]. The basic idea includes the selection of the instants as an additional degree of freedom to the control as shown in the modified control loop in Figure 4.1b). Several methods have been investigated in the literature as presented in the introductory paper [147] based on Input-to-State Stability (ISS) [7, 9, 82, 339], on Lyapunov-based approach [310, 311, 338], on delay modeling [249, 351, 363],

on passivity arguments [349] and, of course, on a hybrid dynamical systems modeling [118, 119] in [1, 93, 252, 251].

Various problems and extensions have been investigated in the literature in this direction, such as output feedback control [1, 2, 78, 314, 349, 349, 363], saturated control [315, 313, 342], periodic event triggered [146, 145, 250] to avoid Zeno, and multi-agent systems [76, 87, 316, 204]. Of course, the reference is far from being exhaustive.

In order to understand the main difference with respect to the robust sampled-data case, let us take a look at the hybrid dynamical system formulation for event-triggered control sampled-data systems. This class of systems can be modeled efficiently using this framework and results from a light but relevant modification of (4.1), leading to the following equation.

$$\begin{cases} \dot{x} &= Ax + Bz, \\ \dot{z} &= 0, \\ \dot{\tau} &= 1, \end{cases} \quad (x, z, \tau) \in \mathcal{C} = \{(x, z, \tau) \in \mathbb{R}^{n+m+1}, \{\tau \leq T\} \cup \mathcal{F}\} \\ \\ \begin{cases} x^+ &= x, \\ z^+ &= Kx, \\ \tau^+ &= 0, \end{cases} \quad (x, z, \tau) \in \mathcal{D} = \{(x, z, \tau) \in \mathbb{R}^{n+m+1}, \{\tau \geq T\} \cap \mathcal{J}\} \end{cases} \quad (4.2)$$

where T is a strictly positive scalar, and \mathcal{F} and \mathcal{J} are subsets of \mathbb{R}^{n+m} . to be defined.

If one wants to understand the dynamics of such systems, one has to see that the system flows while $(x, z, \tau) \in \mathcal{C}$ and jumps whenever $(x, z, \tau) \in \mathcal{D}$. Compared to the robust case, the flow and jump sets are not only characterized by the timer τ but also by the state variables x and z and an event finally corresponds to the situation when the state (x, z) reach the jump set $\mathcal{J} \subset \mathcal{D}$. Therefore, the design of the subset \mathcal{F} and \mathcal{J} gives additional degrees of freedom. Usually, for linear systems, these sets are defined by the sign of a quadratic term. In our recent papers [314, 312], we have provided the following definition

$$\begin{aligned} \mathcal{F} &= \left\{ (x, z), \quad s.t. \quad \begin{bmatrix} x \\ z \end{bmatrix}^T M \begin{bmatrix} x \\ z \end{bmatrix} \leq 0 \right\} \\ \mathcal{J} &= \left\{ (x, z), \quad s.t. \quad \begin{bmatrix} x \\ z \end{bmatrix}^T M \begin{bmatrix} x \\ z \end{bmatrix} \geq 0 \right\} \end{aligned}$$

where M is a constant matrix in \mathbb{S}^{n+m} to be designed. This formulation generalizes the usual ISS formulation. Indeed selecting for instance the following matrix

$$M = \begin{bmatrix} K^T K - \epsilon I_n & -K^T \\ -K & I_m \end{bmatrix}$$

leads to the flowing condition $\|Kx - z\|^2 \leq \epsilon \|x\|^2$. In other words, the controller will not update the control input while the quantity $Kx - z$, which represents the deviation of the continuous artificial control input Kx with respect to the effective control input z , is lower than a quantity depending on the norm of the state x .

Note that in (4.2), the timer τ still plays an important role since the system is not allowed to jump before $\tau = T$. This particular example of event-triggered control formulation is particularly relevant, from both theoretical and practical points of view since it allows us to avoid Zeno phenomenon.

Again, the novelty with respect to what was presented in Chapter 3 relies on the fact that the sampling is now viewed as an additional degree of freedom to the control. In other words, one may

select not only the value of the control input but also the duration of application of the same value. Following this short presentation on event-triggered control, I would like to rise the next perspectives

From time-driven to event-triggered sampled-data control:

How to extend the methodologies developed over the past years to sampled-data systems where the sampling instants may not only depend on time but also on state?

There is no doubt about the possibility to extend the methods developed in the context of robust sampled-data control presented in Chapter 3 to the case of event-triggered control. Indeed following the idea presented in [363, 351]. The potential of using the looped-functional methods can be relevant compared to the usual input delay approach as for the robust sampled-data case.

Tradeoff between communication and performance:

Can we design a cost function, which represents at the same level, the number of control updates and the control performance?

The major benefit of using event-triggered control over periodic time-triggered control is to achieve the same level of performances (such as LQ criteria, for instance) with only fewer control updates. From the networked control point of view, this reduction has a strong impact on the availability of the communication network since less information needs to be transmitted to the plant. However and obviously, there is a tradeoff between the amount of information to be transmitted to the plant and the resulting performance. Indeed, it is expected that reducing the number of control updates would lead to poor performances while, on the opposite, increasing them would lead to the best performance at the price of possible congestion of the communication network. Therefore there is need to find an appropriate tradeoff which gathers this two performances indexes, which are obviously not of the same nature. As far as I know, a proper formulation of such a tradeoff has not been provided in the literature.

I have been working on this subject since 2011 in [310, 311]. With Christophe Prieur, Sophie Tarbouriech and Luca Zaccarian, we have proposed several contributions [313, 315, 312, 330, 331] to the emulation and co-design problems in the situation of actuator saturations. These contributions represent a first step for me on this direction. These researches have been encouraged by the visit of L. Moreira, a PhD Student of UFRGS, Porto Alegre, Brazil, supervised by J.M. Gomes da Silva Jr. and S. Tarbouriech.

In addition, this recent activity (from my part) on event-triggered systems have allowed me to familiarize to the framework of Hybrid Dynamical Systems from [118, 119], on which I have dedicated a lot of attention and several applications. This framework is of a particular relevance to model many applications where the dynamics of a system are characterized by both continuous and discrete evolutions. The potential applications do not resume to the sole sampled-data/event-triggered systems, but to a much wider class of systems, such as the study case on the distributed control of servers we have considered in [5], control of power converters [3] among many others. I envision continuing investigations related to the hybrid dynamical systems framework.

4.3 Stability analysis and control of time-delay systems

4.3.1 Stability analysis of time-delay systems

In Chapter 2, a description of the novel methodology dedicated to the stability analysis of time-delay systems was presented. This methodology based on the use of efficient integral inequalities issued from the theory of inner products on Hilbert space. The resulting Bessel-Legendre inequality has permitted to extend the well known Jensen's inequality to a asymptotically none conservative integral inequality. This method turns out to be very suited to assess stability analysis using the LMI framework. With my colleagues, we have showed that, indeed, it applies efficiently to various classes of delay systems, e.g. constant or time-varying, discrete or distributed delays. A notable aspect of this method is the hierarchical structure of the resulting stability conditions, which seems promising, according to me.

Interestingly, this functional can be seen as an approximation of the complete Lyapunov-Krasovskii functional, which is a necessary and sufficient condition for stability. Hence, I think that the question of convergence of the LMI stability conditions still needs to be addressed. In other words, this corresponds to the following question.

Towards necessity:

If we know that the system is asymptotically stable, does an order N^ exist such that the truncated stability criterion holds?*

This issue corresponds to a challenge for researchers working on the stability analysis of time-delays systems, i.e. providing necessary and sufficient stability LMI conditions for stability.

Looking back to the framework of Bessel-Legendre inequality, one can see that this formulation of Bessel inequality together with the Legendre polynomials has been developed following the classical Lyapunov-Krasovskii functional and to associated inner product on Hilbert space. One may imagine to select other classes of functionals based on other inner products.

Lyapunov design:

Do other classes of orthogonal functions than Legendre polynomials exist that are suitable for the analysis?

For instance, one may look at Laguerre or Tchebitchev polynomials or at trigonometric functions among many others possibilities, which would be associated to other inner products than the standard one used in Chapter 2, and hence to other class of Lyapunov functionals. These considerations may have an interest over Legendre polynomials regarding the tradeoff between numerical complexity and performances of the resulting LMI conditions.

4.3.2 Emphasis on time-varying delay systems

The extension of the Bessel-Legendre methodologies to the time-varying delay case has already been considered in [301]. There are still many activities and improvements that can be done in this direction. One notable aspect is related to the matrix inequalities to be employed in order to transform a non convex LMI problem into a tractable one. Several keys to understand the links between those

inequalities has already been published in [191]. However, this is just a starting point to get a better understanding of the time-varying delay case and of the source of the conservatism.

Reduction of conservatism:

Can we derive novel matrix inequalities dedicated to the stability analysis and control of systems subject to time-varying delays which provide an efficient tradeoff between the reduction of conservatism and the numerical complexity?

The recent activities on free-matrix-based integral inequality [353], reciprocally convex combination lemmas [243, 305, 299, 365], demonstrates the need for further investigations in this area. Probably a unified formulation exists and still needs to be formalized.

In [300, 301], we have introduced the notion of *Allowable Delay Sets*. The main motivation is inspired from the input delay approach for sampled-data systems, where the construction of Lyapunov-Krasovskii functionals take advantages of the sawtooth delay function (see [100, 220, 219]). The main idea is to restrict the stability analysis to delay functions that belong to different sets. More precisely, in [301, 300], we have noticed that the resulting LMI conditions are multi-affine with respect to the delay function h and its derivative \dot{h} . Then, by convexity, the stability conditions need to be verified at the boundaries of the allowable delay set. The simplest characterization of this set would consider all values of the delay $h \in [h_1, h_2]$ and of its derivative $\dot{h} \in [d_1, d_2]$. This corresponds to the polytope in $[h \ \dot{h}]^T$ given by

$$\begin{bmatrix} h \\ \dot{h} \end{bmatrix} \in \mathcal{H}_1 = [0, h_2] \times [d_1, d_2] = Co\left\{ \begin{bmatrix} 0 \\ d_1 \end{bmatrix}, \begin{bmatrix} 0 \\ d_2 \end{bmatrix}, \begin{bmatrix} h_2 \\ d_2 \end{bmatrix}, \begin{bmatrix} h_2 \\ d_1 \end{bmatrix} \right\}. \quad (4.3)$$

and depicted in Figure 4.2(a). Taking a careful attention at the definition of this set, the boundary points

$$\begin{bmatrix} h \\ \dot{h} \end{bmatrix} = \begin{bmatrix} 0 \\ d_1 \end{bmatrix} \quad \text{with } d_1 < 0, \quad \begin{bmatrix} h \\ \dot{h} \end{bmatrix} = \begin{bmatrix} h_2 \\ d_2 \end{bmatrix} \quad \text{with } d_2 > 0,$$

contradict the fact that h_1 and h_2 are respectively the minimum and maximum values of the delay h . Therefore, one may replace these two boundary points by another boundary points $(h, \dot{h}) = (h_1, 0)$ (with $d_1 < 0$) and $(h, \dot{h}) = (h_2, 0)$, leading to some new allowable delay set given for instance by,

$$\begin{bmatrix} h \\ \dot{h} \end{bmatrix} \in \mathcal{H}_2 = Co\left\{ \begin{bmatrix} 0 \\ 0 \end{bmatrix}, \begin{bmatrix} 0 \\ d_2 \end{bmatrix}, \begin{bmatrix} h_2/2 \\ d_2 \end{bmatrix}, \begin{bmatrix} h_2 \\ 0 \end{bmatrix}, \begin{bmatrix} h_2 \\ d_1 \end{bmatrix}, \begin{bmatrix} h_2/2 \\ d_1 \end{bmatrix} \right\}, \quad (4.4)$$

or

$$\begin{bmatrix} h \\ \dot{h} \end{bmatrix} \in \mathcal{H}_3 = Co\left\{ \begin{bmatrix} 0 \\ 0 \end{bmatrix}, \begin{bmatrix} 0 \\ d_2 \end{bmatrix}, \begin{bmatrix} h_2 \\ 0 \end{bmatrix}, \begin{bmatrix} h_2 \\ d_1 \end{bmatrix} \right\}, \quad (4.5)$$

which are depicted in Figure 4.2(b) and (c). These new definitions of the *allowable delay sets* prevent from the situation to get the delay h is at its maximum h_2 (or minimum h_1) as well as its derivative positive (or negative). This selection reduces notably the size of the polytopes. The preliminary result in this direction lets us think that the conservatism of the LMI is not only due to the use of integral and matrix inequalities but also to the selection of the *allowable delay set*.

This new concept also lets us envision a new direction of investigation on the selection of wider classes of *allowable delay sets* for various applications where delays are time-varying but can be characterized in a more accurate manner. For instance, one may think of *allowable delay sets* characterized by a level set of a quadratic expression of the delay value h and its derivative \dot{h} . The

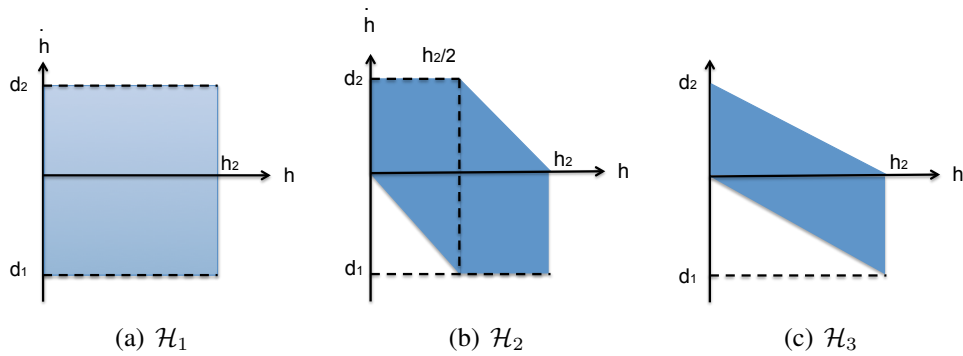

Figure 4.2: Graphical illustration of allowable delay sets.

resulting problem can be reformulated then in the sum of squares framework and easily implemented on Matlab.

4.3.3 Stabilization and control of time-delay systems

As for sampled-data systems, the natural question that follows would be to address the problem of stabilization of time-delay systems, which consists in designing controller laws such that the closed-loop system becomes asymptotically stable. Since our method can be seen as an extended version of the Jensen's inequality, for which many existing methods for control design have been provided, it is expected that the same principle may apply to get constructive stabilization criteria based on the Bessel-Legendre inequality.

Nevertheless, the design of stabilizing static state feedback controller $u(t) = Kx(t)$, for time-delay systems is somehow related to the problem of the design of a static output feedback for linear systems. This problem is known to be non convex. It would be interesting to pursue our preliminary contribution on the design of stabilizing controller already addressed in my PhD [276] and also considered in a recent conference paper [23] with M. Barreau and F. Gouaisbaut. This can be summarized in the following question

Design algorithms:

Is it possible to find an efficient method based on the previous stability conditions, which is able to deliver controller gains for time-delay systems?

As mentioned above, this issue also represents challenging problem in the area of time-delay systems. A promising result is actually under study in the context of the PhD of M. Barreau. This problem is also strongly connected to the design of static output feedback controller for linear systems, which has already attracted many researchers [16, 265, 83].

4.3.4 Finite dimensional controllers and observers for time-delay systems

The problem of observation of time-delay systems has been relatively less addressed in the literature. It generally consists in the natural extensions of undelayed LTI case. The principle, for instance for Luenberger observers [196], is to simulate a copy of the real system dynamics, which is fed by the

measurement outputs. For linear systems with delays, a similar method was applied for instance in [63, 6, 73, 74, 290, 289]. Nevertheless, this method suffers from a particular drawback arising from the infinite dimensional nature of time-delay systems. Indeed, an observer for time-delay systems is meant to estimate the functional state $x_t(\theta)$, for all θ in $[-h, 0]$. From the numerical point of view, this kind of observer cannot be performed properly without using an appropriate approximation method. Usually, this approximation is performed using a discretization of the delay interval and only a partial version of the state is constructed as follows : $x(t - \theta_i)$ for some values of θ_i in $[-h, 0]$ and $i = 0, \dots, N_d$, where N_d represents the discretization order. This process corresponds to a classical way to approximate and simulate the state of time-delay systems and more generally of infinite dimensional systems. An original idea comes from the recent results presented in Chapter 2 and more particularly on the Bessel-Legendre framework. The main idea relies on the approximation of the state function x_t by a finite dimensional state approximation, denoted as

$$\Omega_k(x_t) = \int_{-h}^0 \mathcal{L}_k(u)x_t(u)du, \quad k = 0, \dots, N,$$

where N is any positive integer representing the order of the approximation. A sketch of our original methodology is presented below through some basic considerations on polynomial optimization and some examples.

As mentioned earlier in Chapter 2, there is a strong relationship between the original state function x_t and its projections in the sense of the integral inner product. Indeed, the methodology developed in Chapter 2 is based on the idea that the finite dimensional terms Ω_k , $k \leq N$, represent the coefficients of the unique polynomial that minimizes the distance between x_t and the set of polynomials of degree less than N . In other words, we have

$$x_t(u) \approx \sum_{k=0}^N \frac{2k+1}{h} \Omega_k(x_t) \mathcal{L}_k(u) = \frac{1}{h} \begin{bmatrix} \mathcal{L}_0(u)I & \mathcal{L}_1(u)I & \dots & \mathcal{L}_N(u)I \end{bmatrix} \begin{bmatrix} \Omega_0(x_t) \\ \Omega_1(x_t) \\ \vdots \\ \Omega_N(x_t) \end{bmatrix}. \quad (4.6)$$

Therefore, it would be interesting to investigate and answer to the following questions:

Enlarged control data:

Would it be efficient to not resume the available information to the controller to $x(t)$ or $x(t-h)$ but to consider also the projections $\Omega(x_t)$ in the design of static controller for delay systems?

Since the projections $\Omega_k(x_t)$ represents a partial information of the functional state x_t , it might be relevant to understand if a static controller of the form $u(t) = Kx(t) + K_h x(t-h) + \sum_{k=0}^N K_k \Omega_k(x_t)$, for some gains K , K_h and K_k , $k = 0, \dots, N$, can improve the performances of the closed-loop systems. One may imagine to consider H_∞ or LQR criteria, to evaluate the possible improvement.

If the answer to the previous question is positive, then, the next natural questions are the following ones.

Finite dimensional observers:

Can we built an observer for the time-delay systems to estimate the projections $\Omega_k(x_t)$ in the design of static controller for delay systems?

Indeed, as showed in Chapter 2, the dynamics of the projections depends on $\Omega_k(x_t)$ and on $x(t)$ and/or $x(t - h)$. The remaining question would be to understand the observability or detectability properties of the time-delay system in order to ensure the convergence of the observer. Moreover in light of the approximation (4.6), this also mean that this new class of observers for delay systems would represent a finite dimensional observer for delay systems, which might be relevant for numerical applications.

Model reduction and predictor controllers:

Could the projections $\Omega_k(x_t)$ be employed to make the discretization process of predictor-based controllers more robust?

The frameworks of model reduction and of predictor-based controllers have been very popular over the last years (see for instance [202, 201, 178, 179] and the references therein). Despite their theoretical efficiency, such a class of controllers are of infinite dimensional nature. Therefore, the numerical implementation is a key issue when implementing numerically such controllers. This discretization is often or always performed by dividing the delay interval in small pieces. One may find in the approximation (4.6) using projections, a better and more robust way of implementing the controller. As a non negligible counterpart of this method, the Lyapunov analysis would include the stability of the closed-loop system and the discretization of the controller, in a single and global manner.

4.4 Stability and control of linear infinite dimensional systems

Infinite dimensional systems are characterized by an infinite-dimensional state function $x(t, u)$ where t is the time variable and where u is the spatial variable considered over a given interval. In the case of time-delay systems, the state function may be characterized by $x(t, u) = \chi(t - (1 - u)h)$, where $h > 0$ is the delay and for any u in $[0, 1]$. It allows representing the past values of the instantaneous vector over the delay interval $[t - h, t]$. In the case of 1-dimensional distributed parameter system, the same interval $[0, 1]$ is generally considered but no direct expression as in the case of time-delay systems can be obtained. The positions $u = 0$ and $u = 1$ represent the boundary positions of the distributed parameter system. This characteristic represents the major difficulty to extend classical results obtained in the context of (finite dimensional) linear time-invariant systems to linear infinite dimensional systems driven by Partial Differential Equations (PDEs).

4.4.1 Stability of coupled linear ODE-PDE systems

There exists strong links between time-delay systems and systems driven by PDEs. For example, let us consider the following delay systems driven by the linear dynamics

$$\begin{cases} \dot{x}(t) = Ax(t) + A_d x(t-h) & \forall t \geq 0, \\ x(t) = \phi(t) & \forall t \in [-h, 0], \end{cases} \quad (4.7)$$

where $x(t)$ is the instantaneous state vector, $h > 0$ a constant delay and ϕ the function representing the initial conditions. In order to show the relationship with distributed parameter systems, we recall that the time-delay system (4.7) can be rewritten as the interconnection of an LTI system with a transport PDE (see for instance [101, 135, 159, 222, 261]) given by

$$\begin{cases} \dot{x}(t) & = Ax(t) + A_d z(0, t), \\ \frac{\partial}{\partial t} z(t, u) & = \nu \frac{\partial}{\partial u} z(t, u), \quad \forall u \in [0, 1], \quad h\nu = 1 \\ z(t, 1) & = x(t) \end{cases} \quad (4.8)$$

where z is the functional state of the transport equation. Following the same framework as in [297], the sequence of Legendre polynomials allows providing an efficient approximation method of the infinite-dimensional state. Several questions arise from the previous argumentation.

Control design:

Does this methodology apply for the stability analysis and stabilization of any infinite-dimensional systems?

We want to derive simple and finite dimensional stability criteria, i.e. Linear Matrix Inequalities, which are easily implemented on Matlab, instead of Linear Operator Inequalities, which can be only seen as a theoretical tool.

Definition of stability:

While systems (4.7) and (4.8) represent the same dynamic, the notion of stability for both systems differs notably. Therefore which kind of stability can be guaranteed for the PDE-ODE system?

Indeed, stability of time-delay system (4.7) can be assessed using the Lyapunov-Krasovskii theorem, which is related to the supremum norm of the state, i.e. $\sup_{\theta \in [-h, 0]} \|x_t(\theta)\|$. For PDE systems (4.8), stability is related to the \mathcal{L}_2 norm of the state, i.e. $\|x(t)\| + \sqrt{\int_0^1 \|z(t)\|^2}$. Both stability criteria are then different even if the resulting LMI stability conditions are exactly the same as shown in [28]. Further investigations in this direction need to be undertaken.

Lyapunov design:

Do other classes of orthogonal functions than Legendre polynomials exist that are suitable for the analysis depending on the systems under consideration?

For instance, one may look at Laguerre or Tchebitchev polynomials or at trigonometric functions among many others possibilities, which would be associated to other class of inner products, and hence to other class of Lyapunov functionals.

Several contributions in this new and promising direction of research have been already performed during the last year with the PhD students M. Safi and M. Barreau co-supervised with L. Baudouin and F. Gouaisbaut, respectively. On a first hand we have conducted a stability analysis for linear transport PDE interconnected to a linear ODE systems as presented in (4.8) in [28, 267, 266]. Even if this system can be rewritten as a time-delay system, it has been relevant to figure out what were the main differences when establishing asymptotic or exponential stability. As a first sight, time-delay systems have the particularity of having specialized versions of the Lyapunov Theorem, namely the Lyapunov Krasovskii and Rhazumikin theorems which does not hold any more for system (4.8). When one wants to assess stability of (4.8), one has to specify the norm associated to the Lyapunov functionals. We have noticed in [267] that stability in the sense of Lyapunov-Krasovskii implies the stability in the sense of the \mathcal{L}_2 norm but the reverse is not true. These first contributions have allowed us to understand the main difficulties arising from infinite dimensional nature of PDE systems and also helped us to understand several mechanisms that are usually considered in the time-delay systems theory, which are apparently similar but would deserve more attention. For instance, the use of terms $\int_{-h}^0 x_t^T(u) R x_t(u) du$ does not lead to the same class of stability as the same terms but with the time-derivative \dot{x}_t instead of x_t . From a numerical point of view, the second term leads to less conservative results but stability is ensured over a much restricted set compared to the first one. This PDE modeling also gives us some inch to understand the link between the discretized Lyapunov-Krasovskii functional developed by K. Gu in [132, 134] and the one adapted to the use of the Bessel-Legendre inequality. This issue needs to be formalized in future works.

Further investigations on other classes of PDE systems have been already considered. In our recent papers [27, 26], we considered the situation of the simplest heat equation interconnected to a linear ODE systems. The results seem already promising and would deserve more attention. To give a flavor of the result, in [26], we have considered the interconnected heterogeneous system given by

$$\begin{cases} \dot{x}(t) &= A_0 x(t) + B z(0, t), \\ \frac{\partial}{\partial t} z(t, u) &= \gamma \frac{\partial^2}{\partial u^2} z(t, u), \quad \forall u \in [0, 1], \\ z(t, 1) &= K C x(t), \\ \frac{\partial}{\partial u} z(t, 0) &= 0, \end{cases} \quad (4.9)$$

where x and z are the state of the ODE and the functional state of the heat equation, respectively and where the matrices A_0 , B and C are the same as in Example 2 of Chapter 2 presented in equation (2.47), K is a scalar and γ is the diffusion coefficient. Thanks to a stability analysis issue from the application of Bessel-Legendre inequality, LMI stability conditions have been obtained, which lead to the stability map in the plan (K, γ) presented in Figure (4.3) and which demonstrates the potential of the Bessel-Legendre methodology.

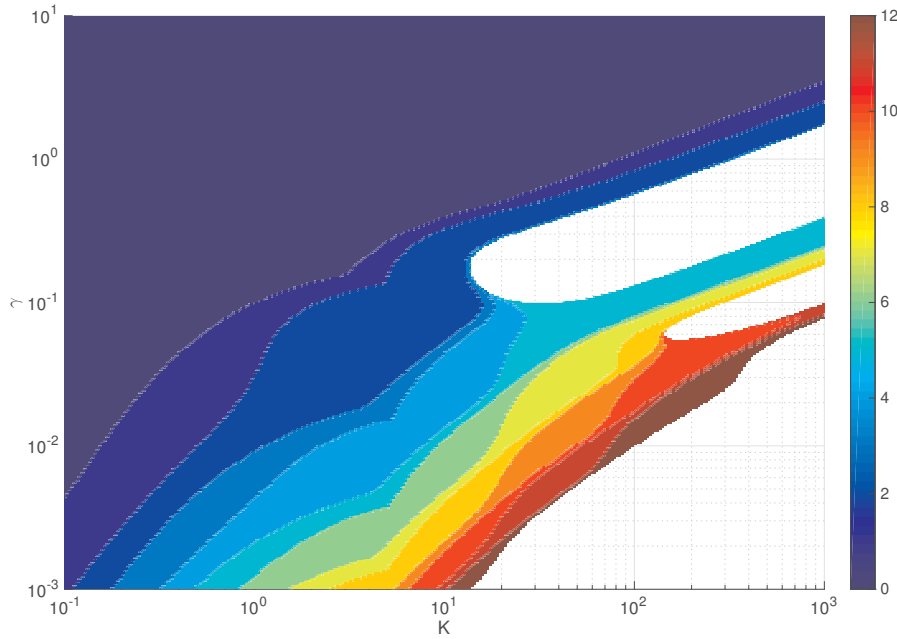

Figure 4.3: Stability region in the plan (K, γ) for $N = 0, \dots, 12$.

In the context of the PhD of M. Barreau, we have studied a similar situation but with the string (or wave) equation instead of the heat equation leading to the contributions of [24]. In both cases, the key issues are related to the use of Bessel inequality together with the properties of the Legendre polynomials. The potential of the method relies also on the fact that tractable and efficient stability tests have been developed in the LMI framework.

We are at the very beginning of this study on wider classes of infinite dimensional systems where our expertise on time-delay systems was a key. Therefore, similar perspectives on the design of finite dimensional controller and observers for infinite dimensional systems also hold and would require a lot of my attention during the following years.

4.4.2 Stabilisation of PDE systems and backstepping methods

If the stability issue is successful, the next step consists naturally in the design of controller for PDE systems. One may consider two distinct control actions to a PDE equation. Indeed, one may act in a distributed way in the domain, $U_d(t, u)$, or at the boundaries of the domain $U_b(t)$ as shown in the following equation, which extends system (4.9) to the case of the stabilization problem

$$\begin{cases} \dot{x}(t) &= A_0 x(t) + Bz(0, t), \\ \frac{\partial}{\partial t} z(t, u) &= \gamma \frac{\partial^2}{\partial u^2} z(t, u) + B_d U_d(t, u), \quad \forall u \in [0, 1], \\ z(t, 1) &= KCx(t) + B_b U_b(t), \\ \frac{\partial}{\partial u} z(t, 0) &= 0, \end{cases} \quad (4.10)$$

where x and z are the state of the ODE and the functional state of the heat equation. Compared to the previous system (4.9), the two additional matrices B_d and B_b represent two input matrices of

appropriate dimensions. The objective becomes to find feedback law U_d and U_b , which stabilize the closed-loop system. Such a problem has been already addressed in the literature. The reader may look at [272, 271] for distributed control action (U_d) or boundary control actions [178, 179, 165, 336] to cite only few. The main idea I envisioned, which is not directly related to the backstepping or predictive approaches, would be to design feedback laws which depend on the projections of the infinite dimensional state function z , i.e.

$$\Omega_k(t) = \int_0^1 \mathcal{L}_k(u)z(t, u)du, \quad k = 0, \dots, N,$$

where $N \in \mathbb{N}$ is any positive integer. This would lead to state feedback laws of the form

$$U_d(t, u) = \sum_{k=1}^N K_d^k \Omega_k(t) \mathcal{L}_k(u),$$

for the distributed control input and

$$U_b(t) = \sum_{k=1}^N K_b^k \Omega_k(t),$$

for the boundary control input. As for delayed or sampled-data systems, the main challenge would be to provide constructive stabilization conditions, expressed in terms of LMIs, which, if verified, deliver the controllers gains K_d^k and K_b^k , for $k = 1, \dots, N$.

As a comment, we keep in mind that the variables Ω_k 's represent the projections of the infinite dimensional state function z . Therefore controller U_b can also be rewritten as $U_b(t) = \int_0^1 K(u)z(t, u)du$, where $K(u) = \sum_{k=1}^N K_b^k \mathcal{L}_k(u)$. One may recover the classical structure of boundary controller resulting from the application of the backstepping method. The similarity with this very popular method let us think that this proposed control structure is relevant. If we can find such stabilization conditions, our method may lead to an interesting alternative to the backstepping method.

A major drawback of the control laws presented above is that they require the complete knowledge of the state. If not, one has to introduce an observer to estimate these projections Ω_k . This is also a relevant problem strongly related to the problem of finite dimensional observers for time-delay systems described earlier in this chapter. It might allow be relevant to design finite-dimensional observers for a larger class of infinite dimensional systems than the sole class of time-delay systems. This idea is now new since a similar problem has been already addressed in [65]. However, the idea of using Bessel-Legendre inequalities together with the use of the associated projections $\Omega_k(z)$ represents, according to me, both a challenging problem and a relevant opportunity for future works.

4.4.3 Sampled-data and event-based control of PDE

Finally, after presenting some perspectives on time-delay systems, sampled-data systems and infinite dimensional systems, the last natural perspective of research would be to consider a mixture of all the methods to address the problem of sampled-data control of PDE systems. By sampled-data control of infinite dimensional systems, we may consider the problem of robust sampled-data control, where the problem is to evaluate the robustness of controller with respect to the perturbation induces by a periodic or asynchronous sampling or it may also corresponds to the case of event-triggered control, where, again, the sampling instants are seen as additional degrees of freedom. One of the first

difficulty that one has to face when considering this problem is the well-posedness of the problem. Indeed, the existence and unicity of solutions to an infinite dimensional systems subject to discontinuous input has to be considered with precaution. To this end, the works of [85, 142, 167, 181, 235, 254] have already addressed this issue and will be probably of great help.

Concerning the robust case, there already exists several work in the literature as for instance in [102, 103, 167, 272]. Once and if the previous perspectives on the stability analysis of infinite-dimensional systems are feasible, the natural step would consists in applying the methodologies employed in Chapter 3 on sampled-data control of finite dimensional systems. A relevant question becomes:

Robust sampled-data control:

It is possible to extend the loop-functional method to the case of infinite dimensional systems?

Answering to this question would allow us to straightforwardly apply the same procedure as the one presented in Chapter 3. Nevertheless, to do so, the main difficulties, according to me would be to ensure that the system behaves well during the inter sampling interval.

Concerning the event-triggered control scheme, one can already find several solutions in the literature. Following the idea of event-triggered control for finite-dimensional systems and, potentially, the previous item on robust sampled-data analysis of PDE systems, I think it would be relevant to address this problem. One can already see in the literature several results in this direction. The reader may refer to [85, 86, 348] for hyperbolic systems and to [270] for distributed parameter systems. The main question becomes

Event-triggered control:

It is possible to extend the methodologies applied for the finite dimensional case to the infinite one?

The main direction for the next research would be to understand how the design and co-design methods provided in my earlier research on finite dimensional systems [312, 315] can be adapted in an efficient manner to the infinite dimensional case.

Bibliography

- [1] M. Abdelrahim, R. Postoyan, J. Daafouz, and D. Nešić. Co-design of output feedback laws and event-triggering conditions for linear systems. In *53rd IEEE Conference on Decision and Control, (CDC 2014)*, pages 3560–3565, Los Angeles, USA, December 2014.
- [2] M. Abdelrahim, R. Postoyan, J. Daafouz, and D. Nešić. Output feedback event-triggered control. In A. Seuret, L. Hetel, J. Daafouz, and K.H. Johansson, editors, *Delays and Networked Control Systems*, pages 113–131. Springer Verlag, 2016.
- [3] C. Albea, G. Garcia, and L. Zaccarian. Hybrid dynamic modeling and control of switched affine systems: Application to dc-dc converters. In *CDC*, pages 2264–2269, 2015.
- [4] C. Albea, A. Seuret, and L. Zaccarian. Hybrid control of a three-agent network cluster. In *IEEE Conference on Decision and Control*, San Francisco, USA, 2014.
- [5] C. Albea, A. Seuret, and L. Zaccarian. Activation and consensus control of a three-node server network cluster via hybrid approach. *Nonlinear Analysis: Hybrid Systems*, 22:16–30, 2016.
- [6] A. Alif, M. Boutayeb, and M. Darouach. Observers based control for systems with unknown delays. In *IFAC Workshop on Time Delay Systems*, September 2003.
- [7] A. Anta and P. Tabuada. Self-triggered stabilization of homogeneous control systems. In *IEEE American Control Conference*, pages 4129–4134, 2008.
- [8] A. Anta and P. Tabuada. To sample or not to sample: Self-triggered control for nonlinear systems. *IEEE Trans. on Automatic Control*, 55:2030 – 2042, 2010.
- [9] A. Anta and P. Tabuada. To sample or not to sample: self-triggered control for nonlinear systems. *IEEE Trans. on Automatic Control*, 55(9):2030–2042, 2010.
- [10] J. Anthonis, A. Seuret, J.-P. Richard, and H. Ramon. Design of a pressure control system with dead band and time delay. *IEEE Trans. on Control Systems Technology*, 15(6):1103–1111, 2007.
- [11] P. Apkarian and H.D. Tuan. Parameterized lmis in control theory. *SIAM Journal on Control and Optimization*, 38(4):1241–1264, 2000.
- [12] A. Arce Rubio, A. Seuret, Y. Ariba, and Manisi A. Optimal control strategies for load carrying drones. In A. Seuret, L. Hetel, J. Daafouz, and K.H. Johansson, editors, *Delays and Networked Control Systems*, pages 175–189. Springer Verlag, 2016.
- [13] Y. Ariba and F. Gouaisbaut. An augmented model for robust stability analysis of time-varying delay systems. *Int. Journal of Control*, 82:1616–1626, September 2009.
- [14] Y. Ariba and F. Gouaisbaut. Input-output framework for robust stability of time-varying delay systems. In *Conference on Decision and Control and Chinese Control Conference. (CDC - CCC'09)*, pages 274–279. IEEE, 2009.
- [15] Y. Ariba, F. Gouaisbaut, and K.H. Johansson. Stability interval for time-varying delay systems. In *49th IEEE Conference on Decision and Control (CDC'10)*, pages 1017 –1022, 2010.
- [16] D. Arzelier, D. Peaucelle, and S. Salhi. Robust static output feedback stabilization for polytopic uncertain systems: improving the guaranteed performance bound. *IFAC Proceedings Volumes*, 36(11):425–430, 2003.
- [17] K-E Årzén. A simple event-based PID controller. In *Preprints of the 14th World Congress of IFAC*, Beijing, P.R. China, 1999.

- [18] K.J. Åström. Event based control. In *Analysis and design of nonlinear control systems*, pages 127–147. Springer, 2008.
- [19] K.J. Åström and R.M. Murray. *Feedback systems: an introduction for scientists and engineers*. Princeton university press, 2010.
- [20] K.J. Åström and B. Wittenmark. *Computer-controlled systems: theory and design*. Prentice-Hall, 1997.
- [21] R. Baheti and H. Gill. Cyber-physical systems. *The impact of control technology*, 12:161–166, 2011.
- [22] D.D. Bainov and P.S. Simeonov. *Systems with impulse effects: Stability, theory and applications*. Academy Press, 1989.
- [23] M. Barreau, A. Seuret, and F. Gouaisbaut. Wirtinger-based exponential stability for time-delay systems. In *IFAC World Congress*, Toulouse, France, 2017.
- [24] M. Barreau, A. Seuret, F. Gouaisbaut, and L. Baudouin. Lyapunov stability analysis of a string equation coupled with an ordinary differential system. *to appear in IEEE Trans. Automatic Control*, 2018.
- [25] G. Bastin and J.-M. Coron. Stability and boundary stabilization of 1-d hyperbolic systems, 2016.
- [26] L. Baudouin, A. Seuret, and F. Gouaisbaut. Stability analysis of a system coupled to a heat equation. *submitted to Automatica*, *arXiv preprint arXiv:1707.07967*, 2017.
- [27] L. Baudouin, A. Seuret, F. Gouaisbaut, and M. Dattas. Lyapunov stability analysis of a linear system coupled to a heat equation. In *IFAC World Congress*, 2017.
- [28] L. Baudouin, A. Seuret, and M. Safi. Stability analysis of a system coupled to a transport equation using integral inequalities. In *IFAC Workshop on Control of Systems Governed by Partial Differential Equations (CPDE'16)*, June 2016.
- [29] R. Bellman and S.L. Cooke. *Differential Difference Equations*. Academic Press, New York, 1963.
- [30] P.-A. Bliman. LMI characterization of the strong delay-independent stability of linear delay systems via quadratic Lyapunov–Krasovskii functionals. *Systems & Control Letters*, 43(4):263–274, 2001.
- [31] P.-A. Bliman. Lyapunov-Krasovskii functionals and frequency domain: Delay-independent absolute stability criteria for delay systems. *Int. Journal of Robust and Nonlinear Control*, 11(8):771–788, 2001.
- [32] D. Breda, S. Maset, and R. Vermiglio. Trace-dde: a tool for robust analysis and characteristic equations for delay differential equations. In *Topics in Time Delay Systems*, volume 388 of *Lecture Notes in Control and Information Sciences*, pages 145–155. Springer Berlin Heidelberg, 2009.
- [33] L. Briñón-Arranz, L. Schenato, and A. Seuret. Distributed source seeking via a circular formation of agents under communication constraints. *IEEE Trans. on Control of Network Systems*, 3(2):104–115, 2016.
- [34] L. Briñón-Arranz, A. Seuret, and C. Canudas-de-Wit. Translation control of a fleet circular formation of AUVs under finite communication range. In *IEEE Conference on Decision and Control (CDC'09)*, pages 8345–8350, 2009.
- [35] L. Briñón-Arranz, A. Seuret, and C. Canudas-de-Wit. Contraction control of a fleet circular formation of AUVs under limited communication range. In *IEEE American Control Conference (ACC'2010)*, pages 5991–5996, 2010.
- [36] L. Briñón-Arranz, A. Seuret, and C. Canudas-de-Wit. General framework using affine transformations to formation control design. In *IFAC Workshop on Distributed Estimation and Control in Networked Systems (Necsys'10)*, 2010.
- [37] L. Briñón-Arranz, A. Seuret, and C. Canudas-de-Wit. Collaborative estimation of gradient direction by a formation of AUVs. In *5th International ICST Conference on Performance Evaluation Methodologies and Tools (ValueTools'11)*, 2011.
- [38] L. Briñón-Arranz, A. Seuret, and C. Canudas-de-Wit. Collaborative estimation of gradient direction by a formation of AUVs under communication constraints. In *IEEE Conference on Decision and Control, held jointly with the European Control Conference, CDC-ECC'11*, 2011.
- [39] L. Briñón-Arranz, A. Seuret, and C. Canudas-de-Wit. Elastic formation control based on affine transformations. In *IEEE American Control Conference (ACC'11)*, 2011.

- [40] C. Briat. Convergence and equivalence results for the Jensen's inequality - application to time-delay and sampled-data systems. *IEEE Trans. on Automatic Control*, 56(7):1660–1665, 2011.
- [41] C. Briat. Stability analysis and control of a class of LPV systems with piecewise constant parameters. *Systems & Control Letters*, 82:10–17, 2015.
- [42] C. Briat. Theoretical and numerical comparisons of looped functionals and clock-dependent Lyapunov functions - the case of periodic and pseudo-periodic systems with impulses. *Int. Journal of Robust and Nonlinear Control*, 26(10):2232–2255, 2015.
- [43] C. Briat. Stability analysis and stabilization of stochastic linear impulsive, switched and sampled-data systems under dwell-time constraints. *Automatica*, 74:279–287, 2016.
- [44] C. Briat. Dwell-time stability and stabilization conditions for linear positive impulsive and switched systems. *Nonlinear Analysis: Hybrid Systems*, 24:198–226, 2017.
- [45] C. Briat. Stability analysis and stabilization of lpv systems with jumps and piecewise differentiable parameters using continuous and sampled-data controllers. *arXiv preprint arXiv:1705.00056*, 2017.
- [46] C. Briat and A. Seuret. Stability criteria for asynchronous sampled-data systems—a fragmentation approach. *IFAC Proceedings Volumes*, 44(1):1313–1318, 2011.
- [47] C. Briat and A. Seuret. Convex dwell-time characterizations for uncertain linear impulsive systems. *IEEE Trans. on Automatic Control*, 57(12):3241–3246, 2012.
- [48] C. Briat and A. Seuret. A looped-functional approach for robust stability analysis of linear impulsive systems. *Systems & Control Letters*, 61(10):980–988, 2012.
- [49] C. Briat and A. Seuret. Affine characterizations of minimal and mode-dependent dwell-times for uncertain linear switched systems. *IEEE Trans. on Automatic Control*, 58(5):1304–1310, 2013.
- [50] C. Briat and A. Seuret. On the necessity of looped-functionals arising in the analysis of pseudo-periodic, sampled-data and hybrid systems. *International Journal of Control*, 88(12):2563–2569, 2015.
- [51] C. Briat and E.I. Verriest. A new delay-SIR model for pulse vaccination. *Biomedical signal processing and control*, 4:272–277, 2009.
- [52] L. Brinón-Arranz, A. Seuret, and C. Canudas de Wit. Cooperative control design for time-varying formations of multi-agent systems. *IEEE Trans. on Automatic Control*, 59(8):2283–2288, 2014.
- [53] R.W. Brockett and D. Liberzon. Quantized feedback stabilization of linear systems. *IEEE trans. on Automatic Control*, 45(7):1279–1289, 2000.
- [54] C. Cai, A. R. Teel, and R. Goebel. Converse Lyapunov theorems and robust asymptotic stability for hybrid systems. In *American Control Conference*, pages 12–17, Portland, Oregon, USA, 2005.
- [55] C. Cai, A. R. Teel, and R. Goebel. Smooth Lyapunov functions for hybrid systems part ii: (pre)asymptotically stable compact sets. *IEEE Trans. on Automatic Control*, 53(3):734–748, 2008.
- [56] Y. Cao, Z. Lin, and T. Hu. Stability analysis of linear time-delay systems subject to input saturation. *IEEE Trans. on Circuit and Systems I*, 49:233–240, 2002.
- [57] Y.-Y. Cao, Y.-X. Sun, and C. Cheng. Delay-dependent robust stabilization of uncertain systems with multiple state delays. *IEEE Trans. on Automatic Control*, 43(11):1608–1612, 1998.
- [58] J. Chen, J. Lu, and S. Xu. Summation inequality and its application to stability analysis for time-delay systems. *IET Control Theory & Applications*, 2016.
- [59] J. Chen, S. Xu, W. Chen, B. Zhang, Q. Ma, and Y. Zou. Two general integral inequalities and their applications to stability analysis for systems with time-varying delay. *Int. Journal of Robust and Nonlinear Control*, 2016.
- [60] T. Chen and B.A. Francis. *Optimal sampled-data control systems*. Springer-Verlag, Berlin, Germany, 1995.
- [61] W.-H. Chen, Z.-H. Guan, and X. Lu. Delay-dependent exponential stability of uncertain stochastic systems with multiple delays: an LMI approach. *Systems & Control Letters*, 54(6):547–555, 2005.

- [62] W.-H. Chen and W.X. Zheng. Delay-dependent robust stabilization for uncertain neutral systems with distributed delays. *Automatica*, 43(1):95–104, 2007.
- [63] H.H. Choi and M.J. Chung. Observer-based H^∞ controller design for state delayed linear systems. *Automatica*, 32(7):1073–075, 1996.
- [64] N. Chopra, M.W. Spong, S. Hirche, and M. Buss. Bilateral teleoperation over the internet: the time varying delay problem. *Urbana*, 101:61801, 2003.
- [65] P.D. Christofides and P. Daoutidis. Finite-dimensional control of parabolic PDE systems using approximate inertial manifolds. In *IEEE Conference on Decision and Control*, 1997.
- [66] M.B.G. Cloosterman, L. Hetel, N. Van de Wouw, W.P.M.H. Heemels, J. Daafouz, and H. Nijmeijer. Controller synthesis for networked control systems. *Automatica*, 46(10):1584–1594, 2010.
- [67] Jennie Cochran and Miroslav Krstic. Source seeking with a nonholonomic unicycle without position measurements and with tuning of angular velocity part i: Stability analysis. In *IEEE Conference on Decision and Control*, 2007.
- [68] K.L. Cooke and Z. Grossman. Discrete delay, distributed delay and stability switches. *Journal of Mathematical Analysis and Applications*, 86(2):592–627, 1982.
- [69] J.-M. Coron, B. d’Andrea Novel, and G. Bastin. A strict Lyapunov function for boundary control of hyperbolic systems of conservation laws. *IEEE Trans. on Automatic Control*, 52(1):2–11, Jan 2007.
- [70] J.-M. Coron and Z. Wang. Output feedback stabilization for a scalar conservation law with a nonlocal velocity. *SIAM Journal on Mathematical Analysis*, 45(5):2646–2665, 2013.
- [71] D.F. Coutinho, M. Fu, and C.E. de Souza. Input and output quantized feedback linear systems. *IEEE Trans. on Automatic Control*, 55(3):761–766, 2010.
- [72] R.F. Curtain and H. Zwart. *An introduction to infinite-dimensional linear systems theory*, volume 21. Springer Science & Business Media, 2012.
- [73] M. Darouach. Linear functional observers for systems with delays in the state variables. *IEEE Trans. on Automatic Control*, 46(3):491–497, 2005.
- [74] M. Darouach. Reduced-order observers for linear neutral delay systems. *IEEE Trans. on Automatic Control*, 50(9):1407 – 1413, 2005.
- [75] A. Diagne, G. Bastin, and J.-M. Coron. Lyapunov exponential stability of 1-d linear hyperbolic systems of balance laws. *Automatica*, 48(1):109 – 114, 2012.
- [76] D.V. Dimarogonas, E. Frazzoli, and K.H. Johansson. Distributed event-triggered control for multi-agent systems. *IEEE Trans. on Automatic Control*, 57(5):1291–1297, 2012.
- [77] X. Ding, X. Liu, and S. Zhong. Delay-independent criteria for exponential admissibility of switched descriptor delayed systems. *Applied Mathematics and Computation*, 228:432–445, 2014.
- [78] M.C.F. Donkers and W.P.M.H. Heemels. Output-based event-triggered control with guaranteed \mathcal{L}_∞ -gain and improved event-triggering. In *IEEE Conference on Decision and Control*, pages 3246–3251. IEEE, 2010.
- [79] M.C.F. Donkers, W.P.M.H. Heemels, N. Van de Wouw, and L. Hetel. Stability analysis of networked control systems using a switched linear systems approach. *IEEE Trans. on Automatic control*, 56(9):2101–2115, 2011.
- [80] D.R. Driver. *Ordinary and delay differential equations*. Springer-Verlag, New York, 1977.
- [81] B. Du, J. Lam, Z. Shu, and Z. Wang. A delay-partitioning projection approach to stability analysis of continuous systems with multiple delay components. *IET Control Theory & Applications*, 3(4):383–390, 2009.
- [82] S. Durand and N. Marchand. Further results on event-based PID controller. In *European Control Conference*, 2009.
- [83] Y. Ebihara, D.i Peaucelle, and D. Arzelier. S-variable approach to lmi-based robust control, 2015.
- [84] L. El Ghaoui and S.-I. Niculescu. *Advances in linear matrix inequality methods in control*, volume 2. Siam, 2000.

- [85] N. Espitia, A. Girard, N. Marchand, and C. Prieur. Event-based control of linear hyperbolic systems of conservation laws. *Automatica*, 70:275–287, 2016.
- [86] N. Espitia, A. Girard, N. Marchand, and C. Prieur. Event-based stabilization of linear systems of conservation laws using a dynamic triggering condition. *IFAC-PapersOnLine*, 49(18):362–367, 2016.
- [87] Y. Fan, G. Feng, Y. Wang, and C. Song. Distributed event-triggered control of multi-agent systems with combinatorial measurements. *Automatica*, 49(2):671–675, 2013.
- [88] M. Fang and J.H. Park. A multiple integral approach to stability of neutral time-delay systems. *Applied Mathematics and Computation*, 224:714–718, 2013.
- [89] J.A. Fax and R.M. Murray. Information flow and cooperative control of vehicle formations. *IEEE Trans. on Automatic Control*, 49(9):1465–1476, 2004.
- [90] Z. Feng and J. Lam. Integral partitioning approach to robust stabilization for uncertain distributed time-delay systems. *Int. Journal of Robust and Nonlinear Control*, 22(6):676–689, 2012.
- [91] Z. Feng, J. Lam, and G.-H. Yang. Optimal partitioning method for stability analysis of continuous/discrete delay systems. *Int. Journal of Robust and Nonlinear Control*, 25(4):559–574, 2015.
- [92] F. Ferrante, F. Gouaisbaut, and S. Tarbouriech. Stabilization of continuous-time linear systems subject to input quantization. *Automatica*, 58:167–172, 2015.
- [93] F. Forni, S. Galeani, D. Nešić, and L. Zaccarian. Event-triggered transmission for linear control over communication channels. *Automatica*, 50(2):490–498, 2014.
- [94] P. Freitas. Delay-induced instabilities in gyroscopic systems. *SIAM Journal on Control and Optimization*, 39(1):196–207, 2000.
- [95] E. Fridman. Use of models with aftereffect in the problem of design of optimal digital control. *Autom. Remote Control*, 53:1523–1528, 1992.
- [96] E. Fridman. New Lyapunov-Krasvoskii functionals for stability of linear retarded and neutral type systems. *Systems and Control Letters*, 43:309–319, 2001.
- [97] E. Fridman. Stability of linear descriptor systems with delay: A Lyapunov-based approach. *Journal of Mathematical Analysis and Applications*, 273(1):24–44, 2002.
- [98] E. Fridman. Stability of linear functional differential equations: A new Lyapunov technique. In *Proceedings of Mathematical Theory of Networks and Systems*, September 2004.
- [99] E. Fridman. A new Lyapunov technique for robust control of systems with uncertain non-small delays. *IMA Journal of Mathematical Control and Information*, 23(2):165–179, 2006.
- [100] E. Fridman. A refined input delay approach to sampled-data control. *Automatica*, 46(2):421–427, 2010.
- [101] E. Fridman. *Introduction to time-delay systems: Analysis and control*. Springer, 2014.
- [102] E. Fridman and N. Bar Am. Sampled-data distributed h_∞ control of transport reaction systems. *SIAM J. Control & Optimization*, 51(2):1500–1527, 2013.
- [103] E. Fridman and A. Blighovsky. Robust sampled control of a class of semilinear parabolic systems. *Automatica*, 48:826–836, 2012.
- [104] E. Fridman and Y. Orlov. Exponential stability of linear distributed parameter systems with time-varying delays. *Automatica*, 45(1):194–201, 2009.
- [105] E. Fridman, A. Seuret, and J.-P. Richard. Robust sampled-data stabilization of linear systems: An input delay approach. *Automatica*, 40(8):1141–1446, 2004.
- [106] E. Fridman and U. Shaked. Stability and guaranteed cost control of uncertain discrete delay systems. *International Journal of Control*, 45(12):2406–2411, 2000.
- [107] E. Fridman and U. Shaked. A descriptor system approach to H^∞ control of linear time-delay systems. *IEEE Trans. on Automatic Control*, 47(2):253–270, 2002.

- [108] E. Fridman and U. Shaked. An improved stabilization method for linear time-delay systems. *IEEE Trans. on Automatic Control*, 47(11):1931–1937, 2002.
- [109] E. Fridman and U. Shaked. Delay-dependent stability and H^∞ control: constant and time-varying delays. *International Journal of Control*, 76(1):48–60, 2003.
- [110] E. Fridman and U. Shaked. An improved delay-dependent H^∞ filtering of linear neutral systems. *IEEE Trans. on Signal and Processing*, 52(3):668 – 673, 2004.
- [111] E. Fridman and G. Tsodik. H^∞ control of distributed and discrete delay systems via discretized Lyapunov functional. *European Journal of Control*, 15(1):84–94, 2009.
- [112] M. Fu and L. Xie. The sector bound approach to quantized feedback control. *IEEE Trans. on Automatic control*, 50(11):1698–1711, 2005.
- [113] H. Fujioka. Stability analysis of systems with aperiodic sample-and-hold devices. *Automatica*, 45(3):771–775, 2009.
- [114] P. Gahinet and P. Apkarian. A linear matrix inequality approach to H^∞ control. *Int. Journal of Robust and Nonlinear Control*, 4(4):421–448, 1994.
- [115] E. Garcia, P.J. Antsaklis, and L.A. Montestruque. *Model-based control of networked systems*. Springer, 2014.
- [116] E. Garcia, G. Vitaioli, and P.J. Antsaklis. Model-based tracking control over networks. In *Control Applications (CCA), 2011 IEEE International Conference on*, pages 1226–1231. IEEE, 2011.
- [117] J.C. Geromel and G.W. Gabriel. Optimal ℓ_2 state feedback sampled-data control design of Markov jump linear systems. *Automatica*, 54:182–188, 2015.
- [118] R. Goebel, R.G. Sanfelice, and A.R. Teel. Hybrid dynamical systems. *IEEE Control Systems*, 29(2):28–93, 2009.
- [119] R. Goebel, R.G. Sanfelice, and A.R. Teel. Hybrid dynamical systems: modeling, stability, and robustness, 2012.
- [120] J.M. Gomes da Silva, I. Queinnec, A. Seuret, and S. Tarbouriech. Stability analysis of dynamic output controllers under aperiodic sampling and input saturation. In *21st International Symposium on Mathematical Theory of Networks and Systems (MTNS 2014)*, page 6, 2014.
- [121] J.M. Gomes da Silva, I. Queinnec, A. Seuret, and S. Tarbouriech. Regional stability analysis of discrete-time dynamic output feedback under aperiodic sampling and input saturation. *IEEE Trans. on Automatic Control*, 61(12):4176–4182, 2016.
- [122] J.M. Gomes Da Silva and S. Tarbouriech. Antiwindup design with guaranteed regions of stability: an lmi-based approach. *IEEE Trans. on Automatic Control*, 50(1):106–111, 2005.
- [123] J.M. Gomes da Silva Jr, E. Fridman, A. Seuret, and J.-P. Richard. Stabilization of neutral systems with saturating inputs. In *IFAC World Congress*, page reg. paper 4091, July 2005.
- [124] J.M. Gomes da Silva Jr, A. Seuret, E. Fridman, and J.-P. Richard. Stabilisation of neutral systems with saturating control inputs. *International Journal of Systems Science*, 42(7):1093–1103, 2011.
- [125] J.M. Gomes da Silva Jr. and S. Tarbouriech. Anti-windup design with guaranteed region of stability: an LMI-based approach. *IEEE Trans. on Automatic Control*, 50(1):106–111, 2005.
- [126] J.M. Gomes da Silva Jr. and S. Tarbouriech. Anti-windup design with guaranteed regions of stability for discrete-time linear systems. *Syst. & Contr. Lett.*, 55(3):184–192, 2006.
- [127] F. Gouaisbaut, Y. Ariba, and A. Seuret. Bessel inequality for robust stability analysis of time-delay system. In *IEEE Conference on Decision and Control (CDC'13)*, pages 928–933, 2013.
- [128] F. Gouaisbaut, Y. Ariba, A. Seuret, and D. Peaucelle. Stability analysis of time-delay systems via Bessel’s inequality : a quadratic separation approach. *submitted to International Journal of Robustness and Nonlinear Control*, 2016.
- [129] F. Gouaisbaut and D. Peaucelle. Delay-dependent stability analysis of linear time delay systems. In *IFAC Workshop on Time-Delay Systems (TDS'06)*, 2006.

- [130] F. Gouaisbaut and D. Peaucelle. A note on stability of time delay systems. In *5th IFAC Symposium on Robust Control Design (ROCOND'06)*, Toulouse, France, July 2006.
- [131] F. Gouaisbaut and D. Peaucelle. Robust stability of time-delay systems with interval delays. In *IEEE Conference on Decision and Control (CDC'07)*, pages 6328–6333, New Orleans, USA, 2007.
- [132] K. Gu. Discretized LMI set in the stability problem of linear uncertain time-delay systems. *Int. J. of Control*, 68:923 – 934, 1997.
- [133] K. Gu. An integral inequality in the stability problem of time-delay systems. *IEEE Conference on Decision and Control*, 2000.
- [134] K. Gu. A further refinement of discretized Lyapunov functional method for the stability of time-delay systems. *Int. Journal of Control*, 74(10):967 – 976, 2001.
- [135] K. Gu, V.-L. Kharitonov, and J. Chen. *Stability of time-delay systems*. Birkhauser, 2003.
- [136] K. Gu and S.-I. Niculescu. Survey on recent results in the stability and control of time-delay systems. *Journal of Dynamic Systems, Measurement, and Control*, 125(2):158–165, 2003.
- [137] R.A. Gupta and M.-Y. Chow. Networked control system: Overview and research trends. *IEEE Trans. on Industrial Electronics*, 57(7):2527–2535, 2010.
- [138] E. Gyurkovics, K. Kiss, I. Nagy, and T. Takacs. Multiple summation inequalities and their application to stability analysis of discrete-time delay systems. *arXiv preprint arXiv:1512.02052*, 2015.
- [139] E. Gyurkovics and T. Takacs. Multiple integral inequalities and stability analysis of time delay systems. *arXiv preprint arXiv:1602.07887*, 2016.
- [140] Q.-L. Han. A delay decomposition approach to stability of linear neutral systems. In *17th IFAC World Congress, Seoul, South Korea*, 2008.
- [141] Q.-L. Han. A discrete delay decomposition approach to stability of linear retarded and neutral systems. *Automatica*, 45(2):517 – 524, 2009.
- [142] F.M. Hante, G. Leugering, and T.I. Seidman. Switching rules for stabilization of linear systems of conservation laws. *Applied Mathematics and Optimization*, 59(2):275292, 2009.
- [143] Y. He, Q.-G. Wang, C. Lin, and M. Wu. Augmented Lyapunov functional and delay-dependent stability criteria for neutral systems. *Int. Journal of Robust and Nonlinear Control*, 15(18):923–933, 2005.
- [144] Y. He, Q.-G. Wang, L. Xie, and C. Lin. Further improvement of free-weighting matrices technique for systems with time-varying delay. *Automatic Control, IEEE Trans. on*, 52(2):293–299, 2007.
- [145] W.P.M.H. Heemels and M.C.F. Donkers. Model-based periodic event-triggered control for linear systems. *Automatica*, 49(3):698–711, 2013.
- [146] W.P.M.H. Heemels, M.C.F. Donkers, and A.R. Teel. Periodic event-triggered control for linear systems. *IEEE Trans. on Automatic Control*, 58(4):847–861, 2013.
- [147] W.P.M.H. Heemels, K.H. Johansson, and P. Tabuada. An introduction to event-triggered and self-triggered control. In *IEEE Conference on Decision and Control*, pages 3270–3285, Maui (HI), USA, 2012.
- [148] W.P.M.H. Heemels, A.R. Teel, N. Van de Wouw, and D. Nesic. Networked control systems with communication constraints: Tradeoffs between transmission intervals, delays and performance. *IEEE Trans. on Automatic control*, 55(8):1781–1796, 2010.
- [149] W.P.M.H. Heemels, N. Van De Wouw, R. H Gielen, M.C.F. Donkers, L. Hetel, S. Oлару, M. Lazar, J. Daafouz, and S.-I. Niculescu. Comparison of overapproximation methods for stability analysis of networked control systems. In *Proceedings of the 13th ACM international conference on Hybrid systems: computation and control*, pages 181–190. ACM, 2010.
- [150] D. Henrion and J.-B. Lasserre. GloptiPoly: Global optimization over polynomials with Matlab and SeDuMi. *ACM Trans. on Mathematical Software (TOMS)*, 29(2):165–194, 2003.
- [151] D. Henrion, J.-B. Lasserre, and J. Löfberg. Gloptipoly 3: moments, optimization and semidefinite programming. *Optimization Methods & Software*, 24(4-5):761–779, 2009.

- [152] J. P. Hespanha, D. Liberzon, and A. R. Teel. Lyapunov conditions for input-to-state stability of impulsive systems. *Automatica*, 44:2735–2744, 2008.
- [153] J.P. Hespanha, P. Naghshtabrizi, and Y. Xu. A survey of recent results in networked control systems. *Proceedings of the IEEE*, 95(1):138–162, 2007.
- [154] L. Hetel, J. Daafouz, and C. Iung. Stabilization of arbitrary switched linear systems with unknown time-varying delays. *IEEE Trans. on Automatic Control*, 51(10):1668–1674, Oct. 2006.
- [155] L. Hetel, C. Fiter, H. Omran, A. Seuret, E. Fridman, J.-P. Richard, and S.I. Niculescu. Recent developments on the stability of systems with aperiodic sampling: an overview. *Automatica*, 76:309–335, 2017.
- [156] S. Hirche, T. Matiakis, and M. Buss. A distributed controller approach for delay-independent stability of networked control systems. *Automatica*, 45(8):1828–1836, 2009.
- [157] H. Ishii and T. Başar. Remote control of Iti systems over networks with state quantization. *Systems & Control Letters*, 54(1):15–31, 2005.
- [158] D. Jacquet, M. Krstic, and C. Canudas de Wit. Optimal control of scalar one-dimensional conservation laws. In *American Control Conference, 2006*. IEEE, 2006.
- [159] J.Hale. *Theory of functional differential equations*. Springer-Verlag, 1997.
- [160] W. Jiang and A. Seuret. Improved stability analysis of networked control systems under asynchronous sampling and input delay. In *IFAC Workshop on Distributed Control and Estimation of Networked Systems (Necsys'10)*, September 13-14 2010.
- [161] W. Jiang and A. Seuret. Stability analysis for sampled-data systems with input delay. *Advanced Science Letters*, 11(1):456–461, 2012.
- [162] X. Jiang and Q.-L. Han. On H^∞ control for linear systems with interval time-varying delay. *Automatica*, 41:2099–2106, 2005.
- [163] X. Jiang and Q.-L. Han. Delay-dependent robust stability for uncertain linear systems with interval time-varying delay. *Automatica*, 42(6):1059–1065, 2006.
- [164] W.D. Kammler. *A first Course in Fourier Analysis*. Cambridge University Press, Cambridge, 2007.
- [165] W. Kang and E. Fridman. Boundary control of delayed ODE-heat cascade under actuator saturation. *Automatica*, 83:252–261, 2017.
- [166] C.-Y. Kao. An IQC approach to robust stability of aperiodic sampled-data systems. *IEEE Trans. on Automatic Control*, 61(8):2219–2225, 2016.
- [167] C.-Y. Kao and M. Cantoni. Frequency-domain stability criteria for distributed-parameter systems under periodic sampled-data feedback control. In *Australian Control Conference*, 2014.
- [168] C.-Y. Kao and H. Fujioka. On stability of systems with aperiodic sampling devices. *IEEE Trans. on Automatic Control*, 58(8):2085–2090, 2013.
- [169] C. Y. Kao and A. Rantzer. Robust stability analysis of linear systems with time-varying delays. In *16th IFAC World Congress, IFAC WC'05*, Prague, Czech Republic, 2005.
- [170] C.-Y. Kao and A. Rantzer. Stability analysis of systems with uncertain time-varying delays. *Automatica*, 43(6):959–970, 2007.
- [171] H.K. Khalil. *Nonlinear systems*. Prentice-Hall, New Jersey, 2(5):5–1, 1996.
- [172] V.L. Kharitonov. *Time-delay systems: Lyapunov functionals and matrices*. Springer Science & Business Media, 2012.
- [173] V.L. Kharitonov and A. Zhabko. Lyapunov-Krasovskii approach to the robust stability analysis of time-delay systems. *Automatica*, 39(1):15–20, 2003.
- [174] J.-H. Kim. Further improvement of Jensen inequality and application to stability of time-delayed systems. *Automatica*, 64:121–125, 2016.

- [175] V Kolmanovskii and A Myshkis. Introduction to the theory and applications of functional. *Differential Equations*, 463, 1999.
- [176] V.B. Kolmanovskii, S.-I. Niculescu, and J.-P. Richard. On the Lyapunov-Krasovskii functionals for stability analysis of linear delay systems. *Int. J. Control*, 72:374–384, 1999.
- [177] V.B. Kolmanovskii and L.E. Shaikhet. *Control of systems with aftereffect*. American Mathematical Society, 1996.
- [178] M. Krstic. *Delay compensation for nonlinear, adaptive, and PDE systems*. Birkhäuser Boston, 2009.
- [179] M. Krstic and A. Smyshlyaev. *Boundary control of PDEs: A course on backstepping designs*, 2008.
- [180] Y. Labit, D. Peaucelle, and D. Henrion. SeDuMi interface 1.02: a tool for solving LMI problems with SeDuMi. In *Computer Aided Control System Design, 2002. Proceedings. 2002 IEEE International Symposium on*, pages 272–277. IEEE, 2002.
- [181] P.-O. Lamare, A. Girard, and C. Prieur. Switching rules for stabilization of linear systems of conservation laws. *SIAM Journal on Control and Optimization*, 53(3):1599–1624, 2015.
- [182] N.E. Leonard, D.A. Paley, F. Lekien, R. Sepulchre, D.M. Frantatoni, and R.E. Davis. Collective motion, sensor networks and ocean sampling. *Proceedings of the IEEE*, 95(1):48–74, 2007.
- [183] K. Li and J. Baillieul. Robust quantization for digital finite communication bandwidth (dfcb) control. *IEEE Trans. on Automatic Control*, 49(9):1573–1584, 2004.
- [184] X. Li and C.-E. de Souza. Criteria for robust stability and stabilization of uncertain linear systems with state delay. *Automatica*, 33:1657–1662, 1997.
- [185] X. Li, H. Gao, and K. Gu. Delay-independent stability analysis of linear time-delay systems based on frequency discretization. *Automatica*, 70:288–294, 2016.
- [186] D. Liberzon and A.S. Morse. Basic problems in stability and design of switched systems. *IEEE Control systems*, 19(5):59–70, 1999.
- [187] Z. Lin, B.A. Francis, and M. Maggiore. Necessary and sufficient graphical conditions for formation control of unicycles. In *IEEE Trans. on Automatic Control*, 2007.
- [188] K. Liu and E. Fridman. Discontinuous Lyapunov functionals for linear systems with sawtooth delays. In *Proceedings of the 8th IFAC Workshop on Time-Delay Systems*, September 2009.
- [189] K. Liu and E. Fridman. Stability analysis of networked control systems: a discontinuous Lyapunov functional approach. In *Joint 48th IEEE Conference on Decision and Control and 28th Chinese Control Conference*, Shanghai, China, 2009.
- [190] K. Liu and E. Fridman. Wirtinger’s inequality and Lyapunov-based sampled-data stabilization. *Automatica*, 48(1):102–108, 2012.
- [191] K. Liu and A. Seuret. Comparison of bounding methods for stability analysis of systems with time-varying delays. *Journal of the Franklin Institute*, 354(7):2979–2993, 2017.
- [192] K. Liu, A. Seuret, and Y. Xia. Stability analysis of systems with time-varying delays via the second-order bessel-legendre inequality. *Automatica*, 76(2):138–142, 2017.
- [193] J. Löfberg. YALMIP: A toolbox for modeling and optimization in MATLAB. In *Computer Aided Control Systems Design, 2004 IEEE International Symposium on*, pages 284–289. IEEE, 2004.
- [194] I. Lopez, J.L. Piovesan, C.T. Abdallah, D. Lee, O. M. Palafox, M. Spong, and R. Sandoval. Practical issues in networked control systems. In *American Control Conference, Minneapolis, US*, June, 2006.
- [195] J. Louisell. Delay differential systems with time-varying delay: New directions for stability theory. *Kybernetika*, 37(3):239–251, 2001.
- [196] D.G. Luenberger. An introduction to observers. *IEEE Trans. on Automatic Control*, 16:596 – 602, 1971.
- [197] J. Lunze and D. Lehmann. A state-feedback approach to event-based control. *Automatica*, 46(1):211–215, 2010.
- [198] B.G. Marieke, M. Cloosterman, N. Van de Wouw, W.P.M.H. Heemels, and H. Nijmeijer. Stability of networked control systems with uncertain time-varying delays. *IEEE Trans. on Automatic Control*, 54(7):1575–1580, 2009.

- [199] J.A. Marshall, M.E. Brouck, and B.A. Francis. Formations of vehicles in cyclic pursuit. *IEEE Trans. on Automatic Control*, 49(11):1963–1974, 2004.
- [200] S. Martínez, J. Cortes, and F. Bullo. Motion coordination with distributed information. *IEEE Control Systems Magazine*, 27(4):75–88, 2007.
- [201] F. Mazenc, M. Malisoff, and S.-I. Niculescu. Reduction model approach for linear time-varying systems with delays. *IEEE Trans. on Automatic Control*, 59(8):2068–2082, 2014.
- [202] F. Mazenc, S.-I. Niculescu, and M. Krstic. Lyapunov-Krasovskii functionals and application to input delay compensation for linear time-invariant systems. *Automatica*, 48(7):1317–1323, 2012.
- [203] F. Mazenc and C. Prieur. Strict Lyapunov functions for semilinear parabolic partial differential equations. *Mathematical Control and Related Fields*, 1(2):231–250, 2011.
- [204] X. Meng and T. Chen. Event based agreement protocols for multi-agent networks. *Automatica*, 49(7):2125–2132, 2013.
- [205] Y.V. Mikheev, V.A. Sobolev, and E.M. Fridman. Asymptotic analysis of digital control systems. *Autom. Remote Control*, 49(9):1175–1180, 1988.
- [206] P. Millán, L. Orihuela, C. Vivas, and F.R. Rubio. Distributed consensus-based estimation considering network induced delays and dropouts. *Automatica*, 48(10):2726–2729, 2012.
- [207] P. Millán, A. Rodrigues del Nozal, L. Zaccarian, L. Orihuela, and A. Seuret. Distributed implementation and design for state estimation. In *IFAC 2017 World Congress The 20th World Congress of the International Federation of Automatic Control*, 2017.
- [208] L. Mirkin. Exponential stability of impulsive systems with application to uncertain sampled-data systems. *IEEE Trans. on Automatic Control*, 52(6):1109–1112, 2007.
- [209] L. Mirkin. Some remarks on the use of time-varying delay to model sample-and-hold circuits. *IEEE Trans. on Automatic Control*, 52(6):1009–1112, 2007.
- [210] A. Molin and S. Hirche. On the optimality of certainty equivalence for event-triggered control systems. *IEEE Trans. on Automatic Control*, 58(2):470–474, 2013.
- [211] Y.S. Moon, P.G. Park, W.H. Kwon, and Y.S. Lee. Delay-dependent robust stabilization of uncertain state-delayed systems. *International Journal of Control*, 74(14):1447–1455, 2001.
- [212] C.-I. Morarescu. *Qualitative analysis of distributed delay systems: Methodology and algorithms*. PhD thesis, Ph. D. thesis, University of Bucharest/Université de Technologie de Compiègne, 2006.
- [213] C.-I. Morarescu, S.-I. Niculescu, and K. Gu. Stability crossing curves of shifted gamma-distributed delay systems. *SIAM Journal on Applied Dynamical Systems*, 6(2):475–493, 2007.
- [214] L. Moreau. Stability of continuous-time distributed consensus algorithms. In *IEEE Conference on Decision and Control*, 2004.
- [215] L. Moreau. Stability of multi-agent systems with time-dependent communication links. *IEEE Trans. on Automatic Control*, 50, 2005.
- [216] A.D. Myshkis. General theory of differential equations with delay. *Transl AMS*, 55:1–62, 19551.
- [217] M. Nagahara, D.E. Quevedo, and J. Ostergaard. Sparse packetized predictive control for networked control over erasure channels. *IEEE Trans. on Automatic Control*, 59(7):1899–1905, 2014.
- [218] P. Naghshtabrizi, J.P. Hespanha, and A.R. Teel. Exponential stability of impulsive systems with application to uncertain sampled-data systems. *Systems and Control Letters*, 57(5):378–385, 2008.
- [219] P. Naghshtabrizi, J.P. Hespanha, and A.R. Teel. Stability of delay impulsive systems with application to networked control systems. *Trans. of the Inst. of Measurement and Control*, Special Issue on Hybrid and Switched Systems, 2009.
- [220] P. Naghshtabrizi, J.P. Hespanha, and A.R. Teel. On the robust stability and stabilization of sampled-data systems: A hybrid system approach. In *Proceedings of the 45th IEEE Conference on Decision and Control*, San Diego, CA, USA, December 13-15, 2006.

- [221] P.T. Nam, H. Trinh, and P.N. Pathirana. Discrete inequalities based on multiple auxiliary functions and their applications to stability analysis of time-delay systems. *Journal of the Franklin Institute*, 352(12):5810–5831, 2015.
- [222] S.-I. Niculescu. *Delay Effects on Stability. A Robust Control Approach*. Springer-Verlag, 2001.
- [223] S.-I. Niculescu and K. Gu. *Advances in time-delay systems*, volume 38. Springer Science & Business Media, 2012.
- [224] P. Öggen, M. Egerstedt, and X. Hu. A control lyapunov function approach to multi-agent coordination. In *IEEE Conference on Decision and Control*, 2004.
- [225] P. Öggen, E. Fiorelli, and N.E. Leonard. Cooperative control of mobile sensor networks: Adaptive gradient climbing in a distributed environment. *IEEE Trans. on Automatic Control*, 49(8):1292–1302, 2004.
- [226] Y. Oishi and H. Fujioka. Stability and stabilization of aperiodic sampled-data control systems: An approach using robust linear matrix inequalities. In *Joint 48th IEEE Conference on Decision and Control and 28th Chinese Control Conference*, December 16-18 2009.
- [227] Y. Oishi and H. Fujioka. Stability and stabilization of aperiodic sampled-data control systems using robust linear matrix inequalities. *Automatica*, 46(8):1327–1333, 2010.
- [228] R. Olfati-Saber. Flocking for multi-agent dynamic systems: Algorithms and theory. *IEEE Trans. on Automatic Control*, 51(3):401–420, 2006.
- [229] R. Olfati-Saber, A. Fax, and R. Murray. Consensus and cooperation in networked multi-agent systems. *Proceedings of the IEEE*, 95(1):215–233, 2007.
- [230] R. Olfati-Saber and R.M. Murray. Consensus problems in networks of agents with switching topology and time-delays. *IEEE Trans. on Automatic Control*, 49(9):1520–1533, 2004.
- [231] R. Olfati-Saber and J. S. Shamma. Consensus filters for sensor networks and distributed sensor fusion. In *Proceedings of the 44th IEEE Conference on Decision and Control, and the European Control Conference 2005, Seville, Spain*, 2005.
- [232] N. Olgac, A.F. Ergenc, and R. Sipahi. ‘delay scheduling’: A new concept for stabilization in multiple delay systems. *Journal of Vibration and Control*, 11(9):1159–1172, 2005.
- [233] H. Omran, L. Hetel, M. Petreczky, J.-P. Richard, and F. Lamnabhi-Lagarrigue. Stability analysis of some classes of input-affine nonlinear systems with aperiodic sampled-data control. *Automatica*, 70:266–274, 2016.
- [234] L. Orihuela, F.R. Rubio, and F. Gómez-Estern. Model-based networked control systems under parametric uncertainties. In *Control Applications, (CCA) & Intelligent Control, (ISIC), 2009 IEEE*, pages 7–12. IEEE, 2009.
- [235] Y.V. Orlov. *Discontinuous systems: Lyapunov analysis and robust synthesis under uncertainty conditions*. Springer Science & Business Media, 2008.
- [236] A. Packard. Gain scheduling via linear fractional transformations. *Systems & Control Letters*, 22(2):79–92, 1994.
- [237] A. Papachristodoulou, J. Anderson, G. Valmorbida, S. Prajna, P. Seiler, and P. Parrilo. Sostools version 3.00 sum of squares optimization toolbox for Matlab. *arXiv preprint arXiv:1310.4716*, 2013.
- [238] A. Papachristodoulou, M. M. Peet, and S.-I. Niculescu. Stability analysis of linear systems with time-varying delays: Delay uncertainty and quenching. In *46th IEEE Conference on Decision and Control (CDC’07)*, New Orleans, LA, USA, 2007.
- [239] M.-J. Park, O.M. Kwon, J.H. Park, and S.-M. Lee. A new augmented Lyapunov-Krasovskii functional approach for stability of linear systems with time-varying delays. *Applied Mathematics and Computation*, 217(17):7197–7209, 2011.
- [240] M.J. Park, O.M. Kwon, J.H. Park, S.M. Lee, and E.J. Cha. Stability of time-delay systems via Wirtinger-based double integral inequality. *Automatica*, 55:204–208, 2015.
- [241] M.J. Park, O.M. Kwon, and A. Seuret. Weighted consensus protocols design based on network centrality for multi-agent systems with sampled-data. *IEEE Trans. on Automatic Control*, 62(6):2916–2922, 2017.

- [242] M.J. Park, O.M. Kwon, and A. Seuret. Closeness-centrality based synchronization criteria for complex dynamical networks with interval time-varying coupling delays. *IEEE Trans. on Cybernetics*, 2018.
- [243] P.G. Park, J.W. Ko, and C. Jeong. Reciprocally convex approach to stability of systems with time-varying delays. *Automatica*, 47(1):235–238, 2011.
- [244] P.G. Park, W.I. Lee, and S.Y. Lee. Auxiliary function-based integral inequalities for quadratic functions and their applications to time-delay systems. *Journal of the Franklin Institute*, 352(4):1378–1396, 2015.
- [245] P. A. Parrilo. *Structured Semidefinite Programs and Semialgebraic Geometry Methods in Robustness and Optimization*. PhD thesis, California Institute of Technology, 2000.
- [246] P. A. Parrilo. Web site for SOSTOOLS. <http://www.cds.caltech.edu/sostools/>, 2004.
- [247] M.M. Peet and P.-A. Bliman. On the conservatism of the sum-of-squares method for analysis of time-delayed systems. *Automatica*, 47(11):2406–2411, 2011.
- [248] M.M. Peet, A. Papachristodoulou, and S. Lall. Positive forms and stability of linear time-delay systems. *SIAM Journal on Control and Optimization*, 47(6):3227–3258, 2009.
- [249] C. Peng and Q.-L. Han. A novel event-triggered transmission scheme and \mathcal{L}_2 control co-design for sampled-data control systems. *IEEE Trans. on Automatic Control*, 58(10):2620–2626, 2013.
- [250] R. Postoyan, A. Anta, W.P.M.H. Heemels, P. Tabuada, and D. Nesic. Periodic event-triggered control for nonlinear systems. In *Decision and Control (CDC), 2013 IEEE 52nd Annual Conference on*, pages 7397–7402. IEEE, 2013.
- [251] R. Postoyan, A. Anta, D. Nešić, and P. Tabuada. A unifying Lyapunov-based framework for the event-triggered control of nonlinear systems. In *Decision and Control and European Control Conference (CDC-ECC), 2011 50th IEEE Conference on*, pages 2559–2564. IEEE, 2011.
- [252] R. Postoyan, P. Tabuada, D. Nešić, and A. Anta. A framework for the event-triggered stabilization of nonlinear systems. *IEEE Trans. on Automatic Control*, 60(4):982–996, 2015.
- [253] S. Prajna, A. Papachristodoulou, and P. A. Parrilo. Introducing SOSTOOLS: a general purpose sum of squares programming solver. *Proceedings of the IEEE Conference on Decision and Control*, 2002.
- [254] C. Prieur, A. Girard, and E. Witrant. Stability of switched linear hyperbolic systems by Lyapunov techniques. *Automatic Control, IEEE Trans. on*, 59(8):2196–2202, 2014.
- [255] M. Putinar. Positive polynomials on compact semi-algebraic sets. *Indiana Univ. Math. J.*, 42(3):969–984, 1993.
- [256] R.L. Raffard, C.J. Tomlin, and S.P. Boyd. Distributed optimization for cooperative agents: Application to formation flight. *IEEE Conference on Decision and Control*, 2004.
- [257] M.A. Rami and X.Y. Zhou. Linear matrix inequalities, Riccati equations, and indefinite stochastic linear quadratic controls. *Automatic Control, IEEE Trans. on*, 45(6):1131–1143, 2000.
- [258] W. Ren and R.W. Beard. *Distributed consensus in multi-vehicle cooperative control*. Springer, 2008.
- [259] C.W. Reynolds. Flocks, herds, and schools: A distributed behavioral model. In *Computer Graphics*, volume 21(4), 1987.
- [260] J.-P. Richard. *Outils mathématiques pour les systèmes dynamiques*. Hermès - Lavoisier, 2002.
- [261] J.-P. Richard. Time delay systems: an overview of some recent advances and open problems. *Automatica*, 39:1667–1694, 2003.
- [262] G. Rodrigues de Campos, D.V. Dimarogonas, A. Seuret, and K.H. Johansson. Distributed control of compact formations for multi-robot swarms. *IMA Journal of Mathematical Control and Information*, page dnw073, 2017.
- [263] G. Rodrigues de Campos and A. Seuret. Continuous-time double integrator consensus algorithms improved by an appropriate sampling. In *IFAC workshop on Distributed estimation and Control in Networked Systems (Nec-sys'10)*, 2010.
- [264] G. Royle and C. Godsil. *Algebraic graph theory*. Springer New York, vol.8, 2001.

- [265] M.S. Sadabadi and D. Peaucelle. From static output feedback to structured robust static output feedback: A survey. *Annual Reviews in Control*, 42:11–26, 2016.
- [266] M. Safi, L. Baudouin, and A. Seuret. Refined exponential stability analysis of a coupled system. In *IFAC World Congress*, 2017.
- [267] M. Safi, L. Baudouin, and A. Seuret. Stability analysis of a system coupled to a transport equation using integral inequalities. *Systems & Control Letters*, to appear in 2017.
- [268] S. Sarlette, A. Bonnabel and R. Sepulchre. Coordinated motion design on Lie groups. *IEEE Trans. on Automatic Control*, 55(5):1047–1058, 2010.
- [269] C.W. Scherer and S. Weiland. Linear matrix inequalities in control. *Lecture Notes, Dutch Institute for Systems and Control, Delft, The Netherlands*, 3, 2000.
- [270] A. Selivanov and E. Fridman. Distributed event-triggered control of transport-reaction systems. *IFAC-PapersOnLine*, 48(11):593–597, 2015.
- [271] A. Selivanov and E. Fridman. Distributed event-triggered control of diffusion semilinear PDEs. *Automatica*, 68:344–351, 2016.
- [272] A. Selivanov and E. Fridman. Sampled-data relay control of diffusion PDEs. *Automatica*, 82:59–68, 2017.
- [273] R. Sepulchre, D.A. Paley, and N.E. Leonard. Graph laplacian and lyapunov design of collective planar motions. *International Symposium on Nonlinear Theory and its Applications*, 2005.
- [274] R. Sepulchre, D.A. Paley, and N.E. Leonard. Stabilization of planar collective motion: All-to-all communication. *IEEE Trans. on Automatic Control*, 52:811–824, 2007.
- [275] R. Sepulchre, D.A. Paley, and N.E. Leonard. Stabilization of planar collective motion with limited communication. *IEEE Trans. on Automatic Control*, 53(3):706–719, 2008.
- [276] A. Seuret. *Commande et observation des systèmes à retards variables: théorie et applications*. PhD thesis, Ecole Centrale de Lille; Univ. des Sciences et Technologie de Lille-Lille I, 2006.
- [277] A. Seuret. Stability analysis for sampled-data systems with a time-varying period. In *48th IEEE Conference on Decision and Control*, December 2009.
- [278] A. Seuret. Exponential stability and stabilization of sampled-data systems with time-varying period. In *Proceedings of the 9th IFAC Workshop on Time-Delay Systems*, June 2010.
- [279] A. Seuret. Stability analysis of networked control systems with asynchronous sampling and input delay. In *American Control Conference (ACC), 2011*, pages 533–538. IEEE, 2011.
- [280] A. Seuret. A novel stability analysis of linear systems under asynchronous samplings. *Automatica*, 48(1):177–182, 2012.
- [281] A. Seuret and C. Briat. Stability analysis of uncertain sampled-data systems with incremental delay using looped-functionals. *Automatica*, 55:274–278, 2015.
- [282] A. Seuret and C. Briat. On the stability analysis of sampled-data systems with delays. In *Delays and Networked Control Systems*, pages 97–112. Springer International Publishing, 2016.
- [283] A. Seuret, C. Briat, and F. Gouaisbaut. Stability analysis of asynchronous sampled-data systems with discrete-time constant input delay. In *Decision and Control (CDC), 2014 IEEE 53rd Annual Conference on*, pages 4342–4347. IEEE, 2014.
- [284] A. Seuret, M. Dambrine, and J.-P. Richard. Robust exponential stabilization for systems with time-varying delays. In *IFAC Workshop on Time delay Systems*, Leuven, 2004.
- [285] A. Seuret, M. Dambrine, and J.-P. Richard. Robust exponential stabilization for systems with time-varying delays. In *5th Workshop on Time Delay Systems*, September 2004.
- [286] A. Seuret, D.V. Dimarogonas, and K.H. Johansson. Consensus of double integrator multi- agents under communication delay. In *IFAC Workshop on Time Delay systems (TDS'09)*, 2008.

- [287] A. Seuret, D.V. Dimarogonas, and K.H. Johansson. Consensus under communication delays. In *IEEE Conference on Decision and Control (CDC'08)*, 2008.
- [288] A. Seuret, C. Edwards, S.K. Spurgeon, and E. Fridman. Static output feedback sliding mode control design via an artificial stabilizing delay. *IEEE Trans. on Automatic Control*, 54(2):256–265, 2009.
- [289] A. Seuret, T. Floquet, and J.-P. Richard. A sliding mode observer for linear systems with unknown time varying delay. In *American Control Conference*, New York, US, 2007.
- [290] A. Seuret, T. Floquet, and J.-P. Richard. Observateurs pour systèmes à retard variable et inconnu. In *Conférence Internationale Francophone en Automatique, CIFA*, “Prix de la meilleure communication doctorant”, 2006.
- [291] A. Seuret and E. Fridman. Wirtinger-like Lyapunov-Krasovskii functionals for discrete-time delay systems. *IMA Journal of Mathematical Control and Information*, 2017.
- [292] A. Seuret, E. Fridman, and J.-P. Richard. Sampled-data exponential stabilization of neutral systems with input and state delays. In *IEEE MED 2005, 13th Mediterranean Conference on Control and Automation*, June 2005.
- [293] A. Seuret and J.-M. Gomes da Silva Jr. Taking into account period variations and actuator saturation in sampled-data systems. *Systems & Control Letters*, 61(12):1286–1293, 2012.
- [294] A. Seuret and F. Gouaisbaut. On the use of the Wirtinger’s inequalities for time-delay systems. In *10th IFAC Workshop on Time Delay Systems (IFAC TDS'12)*, Boston, MA, USA, 2012.
- [295] A. Seuret and F. Gouaisbaut. Integral inequality for time-varying delay systems. In *European Control Conference*, pages 3360–3365, Strasbourg, France, 2013.
- [296] A. Seuret and F. Gouaisbaut. Wirtinger-based integral inequality: Application to time-delay systems. *Automatica*, 49(9):2860–2866, 2013.
- [297] A. Seuret and F. Gouaisbaut. Complete quadratic Lyapunov functionals using Bessel-Legendre inequality. *Proceeding of the 13th European Control Conference*, 2014.
- [298] A. Seuret and F. Gouaisbaut. Hierarchy of LMI conditions for stability of time delay systems. *Systems & Control Letters*, 81:1–7, 2015.
- [299] A. Seuret and F. Gouaisbaut. Delay-dependent reciprocally convex combination lemma. *Internal report HAL*, 2016.
- [300] A. Seuret and F. Gouaisbaut. Allowable delay sets for the stability analysis of linear time-varying delay systems using a delay-dependent reciprocally convex lemma. In *IFAC World Congress*, Toulouse, France, 2017.
- [301] A. Seuret and F. Gouaisbaut. Stability of linear systems with time-varying delays using Bessel-Legendre inequalities. *IEEE Trans. on Automatic Control*, 63(1):225–232, 2018.
- [302] A. Seuret, F. Gouaisbaut, and Y. Ariba. Complete quadratic Lyapunov functionals for distributed delay systems. *Automatica*, 62:168–176, 2015.
- [303] A. Seuret, F. Gouaisbaut, and E. Fridman. Stability of systems with fast-varying delay using improved wirtinger’s inequality. In *Decision and Control (CDC), 2013 IEEE 52nd Annual Conference on*, pages 946–951. IEEE, 2013.
- [304] A. Seuret, F. Gouaisbaut, and E. Fridman. Stability of discrete-time systems with time-varying delays via a novel summation inequality. *IEEE Trans. on Automatic Control*, 60(10):2740–2745, 2015.
- [305] A. Seuret, F. Gouaisbaut, and K. Liu. Discretized Jensen’s inequality: an alternative vision of the reciprocally convex combination lemma. In *14th IFAC Workshop on Time Delay Systems (IFAC TDS'16)*, Istanbul, Turkey, 2016.
- [306] A. Seuret, F. Gouaisbaut, S. Tarbouriech, and J.-M Gomes da Silva Jr. Improved stability criteria for sampled-data systems with input saturation. In *Recent Results on Nonlinear Delay Control Systems*, pages 311–325. Springer International Publishing, 2016.
- [307] A. Seuret, K. Liu, and F. Gouaisbaut. Generalized reciprocally convex combination lemmas and its application to time-delay systems. *Automatica*, 95:488–493, 2018.
- [308] A. Seuret and M.M. Peet. Sum of squares for stability of sampled-data systems. In *IFAC World Congress*, volume 18(1), pages 1441–1446, 2011.

- [309] A. Seuret and M.M. Peet. Stability analysis of sampled-data systems using sum of squares. *IEEE Trans. on Automatic Control*, 58(6):1620–1625, 2013.
- [310] A. Seuret and C. Prieur. Event-triggered sampling algorithms based on a Lyapunov function. In *Decision and Control and European Control Conference (CDC-ECC), 2011 50th IEEE Conference on*, pages 6128–6133. IEEE, 2011.
- [311] A. Seuret, C. Prieur, and N. Marchand. Stability of non-linear systems by means of event-triggered sampling algorithms. *IMA Journal of Mathematical Control and Information*, 31(3):415–433, 2013.
- [312] A. Seuret, C. Prieur, S. Tarbouriech, A Teel, and L. Zaccarian. A nonsmooth hybrid invariance principle applied to robust event-triggered design. *submitted to IEEE Trans. on Automatic Control, Rapport LAAS*, 2017.
- [313] A. Seuret, C. Prieur, S. Tarbouriech, and L. Zaccarian. Event-triggered control with lq optimality guarantees for saturated linear systems. In *9th IFAC Symposium on Nonlinear Control Systems (Nolcos'2013)*, 2013.
- [314] A. Seuret, C. Prieur, S. Tarbouriech, and L. Zaccarian. Event-triggered control via reset control systems framework. *IFAC-PapersOnLine*, 49(18):170–175, 2016.
- [315] A. Seuret, C. Prieur, S. Tarbouriech, and L. Zaccarian. LQ-based event-triggered controller co-design for saturated linear systems. *Automatica*, 74:47–54, 2016.
- [316] G.S. Seyboth, D.V. Dimarogonas, and K.H. Johansson. Event-based broadcasting for multi-agent average consensus. *Automatica*, 49(1):245–252, 2013.
- [317] S.N. Shimanov. On stability in the critical case of a zero root for systems with time lag. *J. Appl. Math. Mech.*, 24:653 – 668, 1960.
- [318] R. Sipahi, S. Niculescu, C.T. Abdallah, W. Michiels, and K. Gu. Stability and stabilization of systems with time delay. *Control Systems, IEEE*, 31(1):38 –65, feb. 2011.
- [319] R. Sipahi and N. Olgac. Complete stability robustness of third-order LTI multiple time-delay systems. *Automatica*, 41(8):1413–1422, 2005.
- [320] R.E. Skelton, T. Iwasaki, and D.E. Grigoriadis. *A unified algebraic approach to control design*. CRC Press, 1997.
- [321] O. Solomon and E. Fridman. New stability conditions for systems with distributed delays. *Automatica*, 49(11):3467 – 3475, 2013.
- [322] M. Souza and J.C. Geromel. On a convex characterisation of stability and performance for hybrid linear systems. In *Decision and Control (CDC), 2015 IEEE 54th Annual Conference on*, pages 6623–6628. IEEE, 2015.
- [323] L. Stone, B. Shulgin, and Z. Agur. Theoretical examination of the pulse vaccination policy in the SIR epidemic model. *Mathematical and computer modelling*, 31:201–215, 2000.
- [324] J. F. Sturm. Using SeDuMi 1.02, a Matlab Toolbox for optimization over symmetric cones. *Optimization Methods and Software*, 11-12:625–653, 1999.
- [325] J. Sun, G.P. Liu, and J. Chen. Delay-dependent stability and stabilization of neutral time-delay systems. *Int. Journal of Robust and Nonlinear Control*, 19(12):1364–1375, 2009.
- [326] J. Sun, G.P. Liu, J. Chen, and D. Rees. Improved delay-range-dependent stability criteria for linear systems with time-varying delays. *Automatica*, 46(2):466 – 470, 2010.
- [327] P. Tabuada. Event-triggered real-time scheduling of stabilizing control tasks. *IEEE Trans. on Automatic Control*, 52(9):1680–1685, 2007.
- [328] P. Tallapragada and N. Chopra. Event-triggered dynamic output feedback control for LTI systems. In *51st IEEE Conference on Decision and Control*, pages 6597–6602, Maui (HI), USA, 2012.
- [329] S. Tarbouriech, G. Garcia, J.M. Gomes da Silva Jr., and I. Queinnec. *Stability and Stabilization of Linear Systems with Saturating Actuators*. Springer, 2011.
- [330] S. Tarbouriech, A. Seuret, J.M. Gomes da Silva Jr., and D. Sbarbaro. Observer-based event-triggered control co-design for linear systems. *IET Control Theory & Applications*, 10(18):2466–2473, 2016.

- [331] S. Tarbouriech, A. Seuret, L. Moreira, and J.-M. Gomes da Silva. Observer-based event-triggered control for linear systems subject to cone-bounded nonlinearities. In *IFAC World Congress*, Toulouse, France, 2017.
- [332] S. Tarbouriech and M. Turner. Anti-windup design: an overview of some recent advances and open problems. *IET control theory & applications*, 3(1):1–19, 2009.
- [333] A.R. Teel. A nonlinear small gain theorem for the analysis of control systems with saturation. *IEEE Trans. on Automatic Control*, 41(9):1256–1270, september 1996.
- [334] G. Valmorbida, M. Ahmadi, and A. Papachristodoulou. Semi-definite programming and functional inequalities for distributed parameter systems. In *Decision and Control (CDC), 2014 IEEE 53rd Annual Conference on*, pages 4304–4309. IEEE, 2014.
- [335] J.G. VanAntwerp and R.D. Braatz. A tutorial on linear and bilinear matrix inequalities. *Journal of Process Control*, 10(4):363–385, 2000.
- [336] R. Vazquez, J.-M. Coron, M. Krstic, and G. Bastin. Local exponential \mathcal{H}_2 stabilization of a 2×2 quasilinear hyperbolic system using backstepping. In *50th IEEE Conference on Decision and Control and European Control Conference (CDC-ECC)*, pages 1329–1334. IEEE, 2011.
- [337] J. Veenman, C.W. Scherer, and H. Koroglu. Robust stability and performance analysis based on integral quadratic constraints. *European Journal of Control*, 31:1 – 32, 2016.
- [338] M. Velasco, P. Martí, and E. Bini. On Lyapunov sampling for event-driven controllers. In *48th IEEE Conference on Decision and Control, 2009 held jointly with the 2009 28th Chinese Control Conference. CDC/CCC 2009*, pages 6238–6243. IEEE, 2009.
- [339] X. Wang and M.D. Lemmon. Event design in event-triggered feedback control systems. In *47th IEEE Conference on Decision and Control*, pages 2105–2110. IEEE, 2008.
- [340] E. Witrant, E. Joffrin, S. Brémond, G. Giruzzi, D. Mazon, O. Barana, and P. Moreau. A control-oriented model of the current profile in tokamak plasma. *Plasma Physics and Controlled Fusion*, 49(7):1075, 2007.
- [341] W. Wolf. Cyber-physical systems. *Computer*, 42(3):88–89, 2009.
- [342] W. Wu, S. Reimann, and S. Liu. Event-triggered control for linear systems subject to actuator saturation. *IFAC Proceedings Volumes*, 47(3):9492–9497, 2014.
- [343] L. Xie, E. Fridman, and U. Shaked. Robust h^∞ control of distributed delay systems with applications to combustion control. *IEEE Trans. on Automatic Control*, 46(12):1930–1935, 2001.
- [344] Q. Xu, G. Stepan, and Z. Wang. Delay-dependent stability analysis by using delay-independent integral evaluation. *Automatica*, 70:153–157, 2016.
- [345] S. Xu and J. Lam. Improved delay-dependent stability criteria for time-delay systems. *ieetac*, 50(3):384–387, March 2005.
- [346] T. Yang. *Impulsive control theory*. Springer-Verlag, 2001.
- [347] T.C. Yang. Networked control system: a brief survey. *IEE Proceedings-Control Theory and Applications*, 153(4):403–412, 2006.
- [348] Z. Yao and N.H. El-Farra. Resource-aware model predictive control of spatially distributed processes using event-triggered communication. In *IEEE Conference on Decision and Control*, pages 3726–3731. IEEE, 2013.
- [349] H. Yu and P.J. Antsaklis. Event-triggered output feedback control for networked control systems using passivity: Achieving \mathcal{L}_2 stability in the presence of communication delays and signal quantization. *Automatica*, 49(1):30–38, 2013.
- [350] D. Yue, Q.-L. Han, and J. Lam. Stability and stabilization of nonuniform sampling systems. *Automatica*, 44(12):3222–3226, 2008.
- [351] D. Yue, E. Tian, and Q.-L. Han. A delay system method for designing event-triggered controllers of networked control systems. *IEEE Trans. on Automatic Control*, 58(2):475–481, 2013.
- [352] S. Zampieri. A survey of recent results in Networked Control Systems. In *Proc. 17th IFAC World Congress*, Seoul, Korea, July 2008.

- [353] H.-B. Zeng, Y. He, M. Wu, and J. She. Free-matrix-based integral inequality for stability analysis of systems with time-varying delay. *IEEE Trans. on Automatic Control*, 60(10):2768–2772, 2015.
- [354] H.-B. Zeng, Y. He, M. Wu, and C.-F. Zhang. Complete delay-decomposing approach to asymptotic stability for neural networks with time-varying delays. *IEEE Trans. on Neural Networks*, 22(5):806–812, 2011.
- [355] H.-B. Zeng, K.L. Teo, and Y. He. A new looped-functional for stability analysis of sampled-data systems. *Automatica*, 2017.
- [356] C.-K. Zhang, Y. He, L. Jiang, M. Wu, and H.-B. Z. Summation inequalities to bounded real lemmas of discrete-time systems with time-varying delay. *IEEE Trans. on Automatic Control*, 2016.
- [357] C.-K. Zhang, Y. He, L. Jiang, M. Wu, and H.-B. Zeng. Stability analysis of systems with time-varying delay via relaxed integral inequalities. *Systems & Control Letters*, 92:52–61, 2016.
- [358] F. Zhang and N.E. Leonard. Cooperative filters and control for cooperative exploration. *IEEE Trans. on Automatic Control*, 55(3):650–663, 2010.
- [359] J. Zhang, C. R. Knopse, and P. Tsiotras. Stability of time-delay systems: Equivalence between Lyapunov and scaled small-gain conditions. *IEEE Trans. on Automatic Control*, 46(3):482–486, March 2001.
- [360] W. Zhang and M.S. Branicky. Stability of networked control systems with time-varying transmission period. In *Allerton Conf. Communication, Control, and Computing*, October 2001.
- [361] W. Zhang, M.S. Branicky, and S.M. Phillips. Stability of networked control systems. *IEEE Control Systems Magazine*, (21), 2001.
- [362] X.-M. Zhang and Q.-L. Han. A delay decomposition approach to delay-dependent stability for linear systems with time-varying delays. *Int. Journal of Robust and Nonlinear Control*, 19(17):1922–1930, 2009.
- [363] X.-M. Zhang and Q.-L. Han. Event-triggered dynamic output feedback control for networked control systems. *IET Control Theory & Applications*, 8(4):226–234, 2014.
- [364] X.-M. Zhang and Q.-L. Han. Abel lemma-based finite-sum inequality and its application to stability analysis for linear discrete time-delay systems. *Automatica*, 57:199–202, 2015.
- [365] X.-M. Zhang, Q.-L. Han, A. Seuret, and F. Gouaisbaut. An improved reciprocally convex inequality and an augmented Lyapunov-Krasovskii functional for stability of linear systems with time-varying delay. *Automatica*, 84:221–226, 2017.

