



HAL
open science

Methods for the Control of Mobile Robots with applications to Multi-robot systems, Shared control and Aerial Robotics

Antonio Franchi

► To cite this version:

Antonio Franchi. Methods for the Control of Mobile Robots with applications to Multi-robot systems, Shared control and Aerial Robotics. Automatic. Institut National Polytechnique de Toulouse, 2016. ⟨tel-02128212⟩

HAL Id: tel-02128212

<https://laas.hal.science/tel-02128212v1>

Submitted on 14 May 2019

HAL is a multi-disciplinary open access archive for the deposit and dissemination of scientific research documents, whether they are published or not. The documents may come from teaching and research institutions in France or abroad, or from public or private research centers.

L'archive ouverte pluridisciplinaire **HAL**, est destinée au dépôt et à la diffusion de documents scientifiques de niveau recherche, publiés ou non, émanant des établissements d'enseignement et de recherche français ou étrangers, des laboratoires publics ou privés.



HAL Authorization

Methods for the Control of Mobile Robots with applications to Multi-robot systems, Shared control and Aerial Robotics

Summary of the research work realized
for the the obtention of the *Habilitation à Diriger des Recherches* (HDR)
from the *Institut National Polytechnique de Toulouse* (INPT)

Antonio FRANCHI

LAAS, CNRS – UPR 8001 LAAS-CNRS
7, avenue du Colonel Roche, 31400 Toulouse, France
afranchi@laas.fr
<http://homepages.laas.fr/afranchi/robotics/>

Defending date: June 27th 2016 at LAAS, CNRS

Members of the Commission:

Reviewers (alph. order)

Prof. **Antonio Bicchi**, *University of Pisa*, Italy
Prof. **Raffaello D'Andrea**, *ETH Zurich*, Switzerland
Prof. **Vijay Kumar**, *University of Pennsylvania*, USA

Examiners (alph. order)

Res. Dir. **Isabelle Fantoni**, *Heudiasyc, Univ. of Technology of Compiègne*, France
Res. Dir. **Simon Lacroix**, *LAAS-CNRS, Univ. of Toulouse*, France
Res. Dir. **Jean-Paul Laumond**, *LAAS-CNRS, Univ. of Toulouse*, France
Prof. **Pascal Morin**, *ISIR, UPMC, University of Paris*, France
Prof. **Giuseppe Oriolo**, *DIAG, Sapienza University of Rome*, Italy

TABLE OF CONTENTS

Preface	5
1 Extended Curriculum Vitae	6
1.1 Short Bio	6
1.2 Personal Data	7
1.3 Education	7
1.4 Professional Experience	7
1.4.1 Academic	7
1.4.2 Industrial	8
1.5 Supervision and Mentoring	8
1.5.1 Postdocs	8
1.5.2 Ongoing PhD students	8
1.5.3 Graduated PhD students	9
1.5.4 M.Sc. Students	9
1.5.5 B.Sc. Students	10
1.6 Teaching	10
1.7 International External Collaboration	11
1.8 Awards, Grants, and Honors	12
1.9 Research Projects and External Funding	12
1.10 Professional Service	13
1.11 Workshop and Invited-session Organization	13
1.12 Summer School Organization	14
1.13 Editorial Service and Committees	14
1.13.1 Editorial Activity	14
1.13.2 Technical Committees	15
1.13.3 Program Committee	15
1.13.4 Journal Reviewer	15
1.13.5 Conference Reviewer	16
1.14 Software Development	16
1.15 Summary of Publications and Invited Talks	16
1.16 Bibliometric indicators	17
1.17 Publications and Invited Talks	17

2	Short Summary of the Research Activity	27
2.1	Master Thesis in Electrical Engineering (Dec. 2005)	27
2.1.1	Multi-robot Exploration (I)	27
2.2	PhD Student in System Engineering at Sapienza University (Nov. 2006 – Feb. 2010)	29
2.2.1	Multi-robot Exploration (II)	29
2.2.2	Mutual Localization with anonymous Relative Measurements	30
2.2.3	Calibration of the Kinematic Parameters with Onboard Sensors only	32
2.2.4	Circular Formation Control and Object Tracking	32
2.2.5	Student Mentoring and PhD Thesis	32
2.3	Visiting PhD Student at University of California at Santa Barbara (Jan 2009 – July 2009)	33
2.3.1	Persistent Monitoring	33
2.3.2	Decentralized Search without Map	34
2.4	Research Scientist: Max Plank Institute for Biol. Cybernetics (Jan. 2010 – Oct. 2012)	35
2.4.1	Teleoperation of Multiple Aerial Robots with Fixed Topology	35
2.4.2	Passivity-based control of Multiple Robots with Switching Topology	37
2.4.3	Additional results on Shared Control with Haptic Feedback	38
2.4.4	Vision-based Formation Stabilization	39
2.4.5	Distributed Control Algorithms based on Generalized-Connectivity	39
2.4.6	Rigidity-based Distributed Control Algorithms	40
2.4.7	Student Mentoring and Participation in the Community	40
2.5	Project Leader: Autonomous Robotics and HMS Group at MPI (Nov. 2012 – Dec. 2013)	40
2.5.1	Haptic Shared Control of Aerial Robots with Onboard Sensors Only	41
2.5.2	Control Aerial Robots in Contact-free Flight (I)	42
2.5.3	Planning & Control of Aerial Robots in Physical Contact (I)	43
2.5.4	Hardware and Software for Aerial Robots	45
2.5.5	Student Mentoring and Participation in the Community	46
2.6	Permanent CNRS Researcher (CR1) at LAAS-CNRS (Jan. 2014 – Today 2016)	46
2.6.1	Control Aerial Robots in Contact-free Flight (II)	46
2.6.2	Planning & Control of Aerial Robots in Physical Contact (II)	47
2.6.3	Design, Modeling and Control of Novel Aerial Robots	49
2.6.4	Decentralized Cooperative Manipulation: Estimation and Control	51
2.6.5	Other Multi-robot Research Activities	52
2.6.6	Student Mentoring and Participation in the Community	52
3	A Focused Chapter: Human-Collaborative Schemes in the Motion Control of Single and Multiple Mobile Robots	55
3.1	Abstract	55

3.2	Introduction	56
3.3	Modeling of the Robot and the Interactions	57
3.3.1	Mobile Robot	57
3.3.2	Communication Infrastructure	58
3.3.3	Human-robot Interface	59
3.4	A Taxonomy of Collaborative Human–robot Control	60
3.4.1	Physical Domain of the Robots	60
3.4.2	Degree of Autonomy from the Human Operator	61
3.4.3	Force Interaction with the Operator	64
3.4.4	Near-operation vs. Teleoperation	66
3.4.5	Physical Interaction with the Environment	66
3.4.6	Use of Onboard Sensors Only	68
3.5	A Taxonomy of Collaborative Human–Multi-robot Control	69
3.5.1	Level of Centralization	70
3.5.2	Master-leader-followers Schemes	71
3.5.3	Formation-orthogonal Control Schemes	72
3.5.4	Group-property Preservation Schemes	74
3.5.5	Physical Interaction with Contact	76
3.6	Conclusions	77
4	A Research Perspective: Control Issues for Autonomy and Interactivity in Decentralized Teams of Heterogeneous Robots	78
4.1	Context, motivation and objectives	78
4.1.1	Context	78
4.1.2	Motivation and objectives	79
4.2	Autonomy for Groups of Heterogeneous Networked Robots	81
4.2.1	Perception and Estimation	82
4.2.2	Motion Planning and Control	83
4.2.3	Cooperative Manipulation	84
4.2.4	Summary and Relationship with our Research	85
4.3	Interactions with Autonomous Groups of Heterogeneous Networked Robots	86
4.3.1	Interaction through Interfaces	86
4.3.2	Direct Interaction	87
4.3.3	Unaware (Invisible) Interaction	88
4.3.4	Summary and Relationship with our Research	89
4.4	Conclusions	89
	Bibliography	90
	A (Franchi et al. 2009)	97
	B (Franchi, Oriolo, and Stegagno 2013)	98
	C (Pasqualetti, Franchi, and Bullo 2012)	99

D (Durham, Franchi, and Bullo 2012)	100
E (Censi et al. 2013)	101
F (Franchi, Stegagno, and Oriolo 2016)	102
G (Franchi et al. 2012c)	103
H (Lee et al. 2013)	104
I (Franchi et al. 2012a)	105
J (Franchi et al. 2012b)	106
K (Robuffo Giordano et al. 2013)	107
L (Zelazo et al. 2014)	108
M (Tognon, Dash, and Franchi 2016)	109

Preface

The present document constitutes a report of my research activity in the period that goes from the obtainment of my master degree (Dec. 2005) to the beginning of 2016.

The report is written with the aim of obtaining the professorial habilitation of the French education system, called “Habilitation à Diriger des Recherches” (HDR), i.e., the “habilitation to direct the research activities”. In France, the HDR is a mandatory step in order to subsequently apply for a full professorship in a university or a research directorship in a research institution.

As a consequence, this document is aimed at illustrating the incrementally acquired capability of the candidate, over the years, of producing and managing a distinctive research activity, by means of research in first-person, of student advisory and supervision, and of obtaining a recognized role as young researcher in the research community.

The document is organized as follows. Chapter 1 provides an extended resume of the candidate. Chapter 2 reports in an extremely concise way, and in chronological order, a series of entry-points to all the main works conducted by candidate during his research activity. Chapter 3 describes in a contextualized way the research of the candidate on a more specific topic, namely the human-collaborative control topic. Chapter 4 presents one of the future research plans of the candidate that concerns with the control of human-collaborative heterogeneous multi-robot systems, and that has been only recently started. Finally, after the [bibliography](#), a selection of published journal papers is reported in the [appendices](#) concludes the document.

Antonio Franchi
Toulouse, May 8th 2016

Chapter 1

Extended Curriculum Vitae

1.1 Short Bio

Antonio Franchi is a Permanent Researcher (CR1) at the Centre National de la Recherche Scientifique (CNRS) in France since January 2014. He is affiliated to the Laboratoire d'Analyse et d'Architecture des Systèmes (LAAS) in Toulouse.

In December 2005 he received the Laurea degree (equiv. to Master degree) (summa cum laude) in Electronic Engineering from the Sapienza University of Rome, Rome, Italy. In February 2010 he received the Ph.D. degree in System Engineering from the Sapienza University of Rome. He was a visiting student with the University of California at Santa Barbara from January 2009 to July 2009.

From January 2010 to October 2012 he was a Research Scientist at the Max Planck Institute for Biological Cybernetics in Germany. From November 2012 to December 2013 he was a Senior Research Scientist and the founder and scientific leader of the group "Autonomous Robotics and Human Machine Systems" in the same institute.

His main research interests include autonomous systems and robotics, with a special regard to control, planning, estimation, human-machine systems, haptics, and hardware/software architectures. His main areas of expertise are multiple-robot systems and aerial robotics.

He published more than 70 papers in international journals and conferences and gave more than 36 invited talks in international venues since 2010. In 2010 he was awarded with the "IEEE RAS ICYA Best Paper Award" for one of his papers on multi-robot exploration.

He is an IEEE Senior Member since April 2016.

Since January 2013 he is Associate Editor of the IEEE Robotics & Automation Magazine and, since January 2014, of the IEEE Aerospace and Electronic Systems Magazine. He has served as associate editor for the 2014, 2015, and 2016 IEEE ICRA and for the 2014, 2015, and 2016 IEEE IROS.

He is the co-founder and co-chair of the IEEE RAS Technical Committee on Multiple Robot Systems. He co-organized workshops on Multiple-robot Systems, Aerial Robots, and Teleoperation at IEEE 2012, 2013, 2014, and 2016 ICRA, 2014 IROS, and RSS 2015. He is a co-organizer of the IEEE-RAS-sponsored 2016 Summer School on Multiple Robot Systems at NUS, Singapore.

1.2 Personal Data

Name: Antonio

Surname: Franchi (pronunciation? IPA: 'franʒi, French/Spanish: franqui, English: fronki, German: franki)

Place of Birth: Rome, Italy

Citizenship: Italian

LAAS, CNRS

7, avenue du Colonel Roche, 31400, Toulouse, France

Tel: +33 (0)56 133 6925

Email: afranchi@laas.fr

Website: <http://homepages.laas.fr/afranchi/robotics/>

Current position: permanent CNRS Researcher (CR1), RIS team, LAAS, CNRS, since January 2014

1.3 Education

Nov.2006–Feb.2010:

- **PhD in System Engineering**,
Sapienza University of Rome,
Advisor: *Prof. Giuseppe Oriolo*
Title: Decentralized Methods for Cooperative Task Execution in Multi-robot Systems

Lug.2007: Habilitation of the Italian Professional Association of Engineers

Dec.2005: Master Degree in Electronic Engineering,

Sapienza University of Rome,

Advisor: *Prof. Giuseppe Oriolo*

Grade: 110/110 cum laude

Title: Coordination and Communication Strategies for Multi-robot Exploration

1.4 Professional Experience

1.4.1 Academic

Jan.2014–today:

- **Permanent Researcher (CR1) at CNRS** (French National Center for the Scientific Research). Member of: LAAS (Laboratory for the Analysis and Architectures of Systems), Toulouse, France;
- **Guest Scientist** at the Max-Planck Institute for Biological Cybernetics, Tübingen, Germany.

Nov.2012–Jan.2014

- **Founder and Head of the Autonomous Robotics and Human Machine Systems group** at Max-Planck Institute for Biological Cybernetics, Tübingen, Germany

Feb.2010–Nov.2012:

- **Research Scientist, associate leader of the Human-Robot Interaction Group** at Max-Planck Institute for Biological Cybernetics, Tübingen, Germany. Department Director: *Prof. Dr. Heinrich H. Bülthoff*

Jan.2009–Jul.2009:

- **Visiting Scholar** at University of California at Santa Barbara, CA, USA. Center for Control, Dynamical Systems, and Computation. Hosting Professor: *Francesco Bullo*

Dec.2005–Mar.2006

- **Engineer** at the Robotics lab of Sapienza University of Rome, Rome, Italy

1.4.2 Industrial

Jan.2008–Dec.2008 Hardware-Firmware developer at *Nergal embedded computing*, Rome, Italy

Mar.2006–Nov.2006 Business consultant at *Accenture*, Rome, Italy

1.5 Supervision and Mentoring

1.5.1 Postdocs

- *M. Ryll (postdoc 2014–2017):* Aerial Robotics
- *P. Stegagno (postdoc 2013):* Multi-robot Anonymous-Measure Localization

1.5.2 Ongoing PhD students

Graduating at LAAS or MPI

- *B. Yüksel (PhD, 2013–2016):* Aerial physical interaction
- *N. Staub (PhD, 2014–2017):* Physical cooperation btw aerial manipulators and humans
- *M. Tognon (PhD, 2015–2018):* Control and planning of aerial robots
- *D. Bicego (PhD, 2016–2019):* Fully-actuated aerial platforms

Co-advised graduating elsewhere

- *G. Michieletto (co-adv.PhD, University of Padua):* Rigidity theory and multi-robot systems
- *M. Mohammadi (co-adv.PhD University of Siena):* Haptic control of cooperative flying robots
- *S. Rajappa (co-adv.PhD University of Tübingen):* Control of fully actuated aerial robots
- *V. Arellano (co-adv.PhD, National Polytechnic of Mexico):* Control of aerial vehicles

Visiting

- *E. Cataldi (visit.PhD 2016, University of Cassino):* Aerial Manipulation
- *J-L. Sánchez López (visit.PhD 2016 Polytechnic of Madrid):* Aerial Vision and Estimation
- *Hyunsoo Yang (visit.PhD 2015, Seoul National University):* Cooperative Aerial-ground Manipulation
- *S. Spedicato (visit.PhD 2013, University of Salento):* Control of Rotocraft-based UAVs

1.5.3 Graduated PhD students

Graduated at LAAS or MPI

- *C. Masone (co-adv.PhD, 2014), Univ. of Stuttgart) :* Bilateral shared planning and control of mobile robots

Co-advised graduated elsewhere

- *G. Gioioso (co-adv.PhD, 2016, Univ. of Siena):* Aerial robot grasping and physical interaction
- *A. Petitti (co-adv.PhD, 2015, Polytechnic of Bari):* Distributed Identification and Control for Cooperative Manipulation
- *P. Stegagno (co-adv.PhD, 2011, Sapienza Univ. of Rome):* Mutual localization of ground aerial robots

Visiting

- *P. Tokekar (visit.PhD, 2013, University of Minnesota):* Tracking with teams of aerial robots

1.5.4 M.Sc. Students

- *D. Petard (M2016):* Cooperative Manipulation
- *H. Tello-Chavez (M2016):* Cooperative Aerial Transportation via Cables
- *D. Bicego (M2016):* Fully-actuated aerial platforms
- *E. Rossi (M2016):* Optimal Control for Tethered Aerial Robots
- *A. Testa (M2016):* Control of Tethered Aerial Robots
- *Y. Solana (M2015):* Motion Planning for Connectivity Maintenance
- *G. Laure (M2015):* Visual Perception and Estimation for Aerial Robots
- *S. Dash (M2015):* Tracking for UAV Tethered to a Platform
- *M. Tognon (M2014):* Control of cm-scale UAVs

- *N. Staub (M2014)*: Identification for Multi-rotor Aerial Robots
- *M. Gagliardi (M2014)*: Vision-based cooperative UAV strategies
- *M. Basile (M2013)*: GPS-enabled UAV teleoperation
- *T. Nestmeyer (M2013)*: Exploration/connectivity maintenance
- *R. Spica (M2012)*: Optimal aerial grasping with a quadrotor UAV
- *M. Riedel (M2012)*: Middleware for human-in-the-loop
- *M. Cagnetti (M2012)*: Bearing-based mutual localization in 3D
- *M. Barbalinardo (M2010)*: Exploration via continuous re-planning
- *P. Stegagno (M2009)*: Multi-robot Mutual localization

1.5.5 B.Sc. Students

- *Y. Delmas*: Design of a light-weight manipulator
- *D. Lucas*: Design of a fully actuated HexaRotor
- *F. Botschen*: Autonomous aerial navigation
- *S. Hartman*: Sensor-based aerial control
- *A. Paolillo, L. Vallone*: IR-based line-following with a WMR
- *F. Ferrante*: Reactive motion strategies for WMR
- *S. M. Pelliccioni, F. Settembre*: Multi-robot PF localization
- *C. Masone, M. Petrocchi, L. Rosa*: Calibration of a diff.-drive WMR
- *E. Bitincka, F. Ramundo, M. Volpe*: Robotic-network deployment
- *M. Paoletti, M. Sassano*: Multi-robot motion planning

1.6 Teaching

- Class on “Control of Multi-robot Systems” at Sapienza University of Rome, Rome, Italy, April-2016
- Class on “Control of multiple robots via passivity and graph theory” at the 2015 SIDRA PhD Summer School on Robot Control, Bertinoro, Italy, July-2015
- Four focused seminars in the “Adaptive Systems” graduate class with title: “Control Problems in Multi-robot Systems”. DIS, University of Rome “La Sapienza”, Roma, Italy, June-2008

1.7 International External Collaboration

For the citations refer to Sec. 1.17. Collaborations with international researchers at LAAS-CNRS or MPI-KYB are excluded from the list.

- Prof. F. Bullo, Full Professor at University of California at Santa Barbara, USA
<http://motion.me.ucsb.edu/>
Topic: Control of multi-robot systems
Results: **J6, J2, C9, C5**
- Prof. D. Zelazo, Assistant Professor Israel Inst. of Technology, Israel
<http://zelazo.net.technion.ac.il/>
Topic: Rigidity-based graph theoretic control and estimation for multi-robot systems
Results: **J12, C57, C42, C32, C19**
- Prof. Cristian Secchi, Associate Professor at the University of Modena and Reggio Emilia, Italy
<http://www.arscontrol.org/cristian-secchi>
Topic: Teleoperation, passivity-based control, shared control of multiple robots
Results: **J8, J4, J3, C43, C34, C29, C21, C16, C14, W2**
- Prof. D.J. Lee, Associate Professor at Seoul National University, Korea
<http://inrol.snu.ac.kr/professor>
Topic: Teleoperation, passivity-based control, shared control of multiple robots
Results: **J9, C15, C12, C11**
Other collaborations: advisor of the visiting PhD student Hyunsoo Yang
- Prof. V. Isler, Associate Professor at the University of Minnesota, USA
<http://www.cs.umn.edu/~isler/>
Topic: Multi-robot tracking
Results: **C53**
Other collaborations: advisor of the visiting PhD student Pratap Tokekar
- Prof. D. Prattichizzo, Full Professor at the University of Siena, Italy
<http://www.dii.unisi.it/~domenico>
Topic: Aerial grasping, haptics, aerial manipulation
Results: **C59, C49, C39, C38**
Other collaborations: advisor of the co-advised PhD students Guido Gioioso and Mostafa Mohammadi
- Prof. G. Antonelli, Associate Professor at the University of Cassino and Southern Lazio, Italy
<http://www.eng.docente.unicas.it/gianlucaAntonelli>
Topic: Aerial robots, adaptive control
Results: **J22, C31**
Other collaborations: advisor of the visiting PhD student Elisabetta Cataldi
- Prof. F. Allgöwer, Full Professor at the University of Stuttgart, Germany
<http://www2.ist.uni-stuttgart.de/allgower/CV.shtml>

Topic: Control of robotic systems

Results: **C19**

Other collaborations: local advisor of the advised PhD student C. Masone and B. Yüksel

- Prof. G. Notarstefano, Assistant Professor at the University of Salento, Italy

<http://cor.unisalento.it/notarstefano>

Topic: Maneuver regulation, aerial robots

Results: **Ch2, C51**

Other collaborations: advisor of the visiting PhD student Sara Spedicato

- Prof. A. Rizzo, Associate Professor at Polytechnic of Turin, Italy

<http://staff.polito.it/alessandro.rizzo>

Topic: Cooperative manipulators, distributed estimation

Results: **J21, C51, C50, C41**

- Prof. R. Carli, Assistant Professor at the University of Padua, Italy

<http://automatica.dei.unipd.it/people/carli.html>

Topic: Multi-robot localization, geometric control.

Results: **C61, C53**

- Prof. A. Cenedese, Assistant Professor at the University of Padua, Italy

<http://automatica.dei.unipd.it/people/cenedese.html>

Topic: Rigidity on manifolds.

Results: **C60**

Other collaborations: advisor of the co-advised PhD student Giulia Michieletto

- Prof. L. Schenato, Associate Professor at the University of Padua, Italy

<http://automatica.dei.unipd.it/people/schenato.html>

Topic: **53**

Results: Multi-robot localization.

1.8 Awards, Grants, and Honors

- IEEE Senior Member, 2016
- IEEE RAS Italian Chapter[†] Young Author Best Paper Award 2010
([†]“RAS Chapter of the year award” both in 2006 and 2009)
- PhD scholarship in System Engineering, awarded by the Italian Ministry of Education, 2006

1.9 Research Projects and External Funding

- 2015–2019 Principal Investigator of LAAS-CNRS @ AEROARMS H2020 EU Project, Total funding: 5M€
- 2016 Eiffel excellence fellowship program, 10 months visiting PhD 20K€

- 2015 DFG research fellowship, 12 months post-doc grant, 50K€
- 2014–2015 Participant @ ARCAS FP7 EU Project, CN 287617, Total funding: 6.15M€
- 2015 Eiffel excellence fellowship program, 10 months visiting PhD grant, 20K€
- 2014 3-year PhD student grant, “Ecole Doctorale Systèmes”, 100K€
- 2014 Eiffel excellence fellowship program, 10 months visiting PhD grant, 20K€
- 2014 Programme ‘nouveaux entrants’, University of Toulouse, 10K€
- 2013 Hosting partner, 2 years Post-doc grant: “TRaVERSE”, FP7-PEOPLE-2013-IEF (Marie Curie Actions) 162K€
- 2013 Hosting partner, 1 year PhD mobility grant; Inter-Polytechnical School, funded by the *Polytechnic of Turin/Milan/Bari, Italy*.
- 2013 Research Training Group: Vision-based Flying Robots, 170K€, funded by the *University of Tübingen, Germany*
- 2012 (and 2013) Submission of *two* STREPs (both passed the first stage) and a FET for the FP7

1.10 Professional Service

- 2016 Evaluator of 7 MIUR PRIN (grants of Italian Ministry of Education and Research) Req. fund: 7x800K€
- 2016 Member of PhD Defense Committee of
Marco Todescato - University of Padua, Italy
Andrea Carron - University of Padua, Italy
Lorenzo De Stefani, - University of Padua, Italy
Roberto Bortoletto - University of Padua, Italy
- 2016 Member of PhD Defense Committee of
Mirko Ferrati - University of Pisa, Italy
Gian Maria Gasparri - University of Pisa, Italy
Hamal Marin - University of Pisa, Italy
- 2014 Evaluation of SNSF–Professorship applications (Switzerland) Stage 2. Req. fund: 1.5M CHF
- 2014 Evaluator of 6 MIUR SIR Stage 1. (grants of Italian Ministry of Education and Research) Req. fund: 6x800K€

1.11 Workshop and Invited-session Organization

- 2016 *IEEE ICRA Workshop on Fielded Multi-Robot Systems Operating on land, Sea, and Air*, Stockholm, Sweden

- *2016 IEEE ICRA Workshop on Aerial Robotics Manipulation: from Simulation to Real-life*, Stockholm, Sweden
- *2015 54th CDC Invited Session: Rigidity Theory for Problems in Multi-Agent Coordination*, Osaka, Japan
- *2015 RSS Workshop on Principle of Multi-Robot Systems*, Rome, Italy
- *2014 IEEE/RJS IROS Workshop on The Future of Multiple-robot Research and its Multiple Identities*, Chicago, IL, USA
- *2014 IEEE ICRA Workshop: On the Centrality of Decentralization in Multi-robot Systems: Holy Grail or False Idol?*, Hong Kong, China
- *2013 IEEE ICRA Demo on Bi-operator Haptic Control of Multiple UAVs with Connectivity Maintenance*, Karlsruhe, Germany
- *2013 IEEE ICRA Technical Tour to the Max Plank Institutes in Tübingen*, Karlsruhe, Germany
- *2013 IEEE ICRA Workshop: Towards Fully Decentralized Multi-Robot Systems: Hardware, Software and Integration*, Karlsruhe, Germany
- *IEEE SMC 2012 Demo Event on Intercontinental Shared Control of Multiple UAVs*, Seoul, Korea
- *12th IAS Demo Event on Intercontinental Shared Control of Multiple UAVs*, Jeju Island, Korea
- *2012 IEEE ICRA Workshop on Haptic Teleoperation of Mobile Robots: Theory, Applications and Perspectives*, St. Paul, MN, USA

1.12 Summer School Organization

- *2016 IEEE RAS Summer School on Multi-Robot Systems*, NUS, Singapore

1.13 Editorial Service and Committees

1.13.1 Editorial Activity

- 2013-today **Associate Editor**, IEEE Robotics & Autom. Magazine
- 2015 **Associate Editor**, IEEE Aerospace and Electronic Systems Magazine
- Associate Editor at 2014-, 2015-, and 2016 IEEE ICRA
- Associate Editor at 2014- 2015-, and 2016 IEEE IROS
- 2014: Supervising Guest Editor of the IEEE RAM Special issue on Open Source and Widely Disseminated Robot Hardware

1.13.2 Technical Committees

- 2014–today: *Co-chair* of the Technical Committee on Multi-Robot Systems of IEEE RAS
<http://multirobotsystems.org/>
- 2014: *Founder* of the Technical Committee on Multi-Robot Systems of IEEE RAS

1.13.3 Program Committee

- IFAC IAV 2016
- DEMUR'16 and DEMUR'16
- AAMAS 2015
- 2014 ODMMRC Workshop
- Macorex Work
- ECAI'14
- IFAC RED-UAS 2013

1.13.4 Journal Reviewer

- IEEE Transaction on Robotics
- International Journal of Robotics Research
- IEEE Robotics and Automation Magazine
- Autonomous Robots
- Automatica
- System & Control Letters
- Robotica
- Robotic Autonomous Systems
- Transaction on Mechatronics
- Annals of Mathematics and Artificial Intelligence
- IET Control Theory & Applications
- IEEE Transactions on Control Systems Technology

1.13.5 Conference Reviewer

- Selected Reviewer at RSS
- IEEE ICRA; IEEE IROS
- IEEE CDC
- IEEE AIM; IEEE WHC; IFAC IAV; CCECE; ECAI, DARS; IFAC MVS; AIM; AAMAS

1.14 Software Development

- 2010–2014: TeleKyb Framework, C++
<http://wiki.ros.org/telekyb>
- 2007–2010: Multirobot integration platform (MIP), C++
<http://www.dis.uniroma1.it/~labrob/software/MIP/>

1.15 Summary of Publications and Invited Talks

Category	Published	Under review	Total
<i>Referred Journal papers</i>	17	5	22
<i>Referred Book chapters</i>	3		3
<i>Referred Conference papers</i>	53	8	61
<i>Workshops papers</i>	13		13
<i>Invited Talks and Seminars</i>	37		37

Journals:

- 4 The International Journal of Robotics Research (1 in a special issue)
- 4 IEEE Transaction on Robotics
- 3 Autonomous Robots
- 2 IEEE/ASME Transactions on Mechatronics (1 in a special issue)
- 1 IEEE Robotics and Automation Magazine (in a special issue)
- 1 IEEE Robotics and Automation Letters
- 1 IEEE Transactions on Systems, Man, and Cybernetics, part B (Cybernetics)
- 1 IEEE Transactions on Control of Network Systems

Conferences:

- 21 IEEE Int. Conf. on Robotics and Automation (ICRA)
- 10 IEEE/RSJ Int. Conf. on Intelligent Robots and System (IROS)
- 6 IEEE Conf. on Decision and Control (CDC)
- 2 Robotics: Science and Systems (RSS)
- 4 European Control Conference (ECC)
- 2 IFAC Work. on Research, Education and Development of Unmanned Aerial Systems
- 2 Int. Conf. on Intelligent Autonomous Systems
- 1 IEEE/ASME Int. Conf. on Advanced Intelligent Mechatronics

- 1 European Conference on Mobile Robots
- 1 IFAC Work. on Multivehicle Systems
- 1 IEEE World Haptics Conference
- 1 IFAC Symp. on Intelligent Autonomous Vehic
- 1 Int. Conf. on Robot Communication and Coordination

1.16 Bibliometric indicators

Google scholar upd. June 9th 2016

<https://scholar.google.com/citations?user=DqOnkE8AAAAAJ>

	All	Since 2011
Citations	1228	1151
h-index	20	20
i10-index	38	36

1.17 Publications and Invited Talks

Submitted Journal Papers

- J22** G. Antonelli, E. Cataldi, F. Arrichiello, P. Robuffo Giordano, S. Chiaverini, and A. Franchi, “Adaptive trajectory tracking for quadrotor MAVs in presence of parameter uncertainties and external disturbances,” Submitted to IEEE/ASME Trans. on Mechatronics,
- J21** A. Franchi, A. Petitti, and A. Rizzo, “Distributed estimation for cooperative mobile manipulation,” Submitted to IEEE Trans. on Robotics,
- J20** C. Masone, P. Robuffo Giordano, and A. Franchi, “Shared planning and control with integral haptic feedback,” Submitted to IEEE Trans. on Robotics,
- J19** M. Tognon and A. Franchi, “Dynamics, control, and estimation for aerial robots tethered by cables or bars,” Submitted to IEEE Trans. on Robotics,
- J18** B. Yüksel and A. Franchi, “Dynamics and control of aerial robots with a rigid-joint or an elastic-joint arm,” Submitted to IEEE Trans. on Robotics,

Accepted/Published Journal Papers

- J17** P. Stegagno, M. Cognetti, G. Oriolo, H. H. Bühlhoff, and A. Franchi, “Ground and aerial mutual localization using anonymous relative-bearing measurements,” IEEE Trans. on Robotics, 2016
- J16** T. Nestmeyer, P. Robuffo Giordano, H. H. Bühlhoff, and A. Franchi, “Decentralized simultaneous multi-target exploration using a connected network of multiple robots,” Autonomous Robots, 2016
- J15** A. Franchi and P. Robuffo Giordano, “Online leader selection for improved collective tracking and formation maintenance,” IEEE Trans. on Control of Network Systems, 2016.
- J14** A. Franchi, P. Stegagno, and G. Oriolo, “Decentralized multi-robot encirclement of a 3D target with guaranteed collision avoidance,” Autonomous Robots, vol. 40, no. 2, pp. 245–265, 2016.
- J13** M. Tognon, S. S. Dash, and A. Franchi, “Observer-based control of position and tension for an aerial robot tethered to a moving platform,” IEEE Robotics and Automation Letters, 2016.

- J12** D. Zelazo, A. Franchi, H. H. Bühlhoff, and P. Robuffo Giordano, “Decentralized rigidity maintenance control with range measurements for multi-robot systems,” *The International Journal of Robotics Research*, vol. 34, no. 1, pp. 105–128, 2014.
- J11** A. Censi, A. Franchi, L. Marchionni, and G. Oriolo, “Simultaneous maximum-likelihood calibration of odometry and sensor parameters,” *IEEE Trans. on Robotics*, vol. 29, no. 2, pp. 475–492, 2013.
- J10** A. Franchi, G. Oriolo, and P. Stegagno, “Mutual localization in multi-robot systems using anonymous relative measurements,” *The International Journal of Robotics Research*, vol. 32, no. 11, pp. 1302–1322, 2013.
- J9** D. J. Lee, A. Franchi, H. I. Son, H. H. Bühlhoff, and P. Robuffo Giordano, “Semi-autonomous haptic teleoperation control architecture of multiple unmanned aerial vehicles,” *IEEE/ASME Trans. on Mechatronics, Focused Section on Aerospace Mechatronics*, vol. 18, no. 4, pp. 1334–1345, 2013.
- J8** P. Robuffo Giordano, A. Franchi, C. Secchi, and H. H. Bühlhoff, “A passivity-based decentralized strategy for generalized connectivity maintenance,” *The International Journal of Robotics Research*, vol. 32, no. 3, pp. 299–323, 2013.
- J7** H. I. Son, A. Franchi, L. L. Chuang, J. Kim, H. H. Bühlhoff, and P. Robuffo Giordano, “Human-centered design and evaluation of haptic cueing for teleoperation of multiple mobile robots,” *IEEE Trans. on Systems, Man, & Cybernetics. Part B: Cybernetics*, vol. 43, no. 2, pp. 597–609, 2013.
- J6** J. W. Durham, A. Franchi, and F. Bullo, “Distributed pursuit-evasion without global localization via local frontiers,” *Autonomous Robots*, vol. 32, no. 1, pp. 81–95, 2012.
- J5** A. Franchi, C. Masone, V. Grabe, M. Ryll, H. H. Bühlhoff, and P. Robuffo Giordano, “Modeling and control of UAV bearing-formations with bilateral high-level steering,” *The International Journal of Robotics Research, Special Issue on 3D Exploration, Mapping, and Surveillance*, vol. 31, no. 12, pp. 1504–1525, 2012.
- J4** A. Franchi, C. Secchi, M. Ryll, H. H. Bühlhoff, and P. Robuffo Giordano, “Shared control: Balancing autonomy and human assistance with a group of quadrotor UAVs,” *IEEE Robotics & Automation Magazine, Special Issue on Aerial Robotics and the Quadrotor Platform*, vol. 19, no. 3, pp. 57–68, 2012.
- J3** A. Franchi, C. Secchi, H. I. Son, H. H. Bühlhoff, and P. Robuffo Giordano, “Bilateral teleoperation of groups of mobile robots with time-varying topology,” *IEEE Trans. on Robotics*, vol. 28, no. 5, pp. 1019–1033, 2012.
- J2** F. Pasqualetti, A. Franchi, and F. Bullo, “On cooperative patrolling: Optimal trajectories, complexity analysis, and approximation algorithms,” *IEEE Trans. on Robotics*, vol. 28, no. 3, pp. 592–606, 2012.
- J1** A. Franchi, L. Freda, G. Oriolo, and M. Vendittelli, “The sensor-based random graph method for cooperative robot exploration,” *IEEE/ASME Trans. on Mechatronics*, vol. 14, no. 2, pp. 163–175, 2009.

Book Chapters

- Ch3** A. Franchi, “Human-collaborative schemes in the motion control of single and multiple mobile robots,” in *Trends in Control and Decision-Making for HumanRobot Collaboration Systems*, Y. Wang and F. Zhang, Eds., Springer, 2016.
- Ch2** S. Spedicato, G. Notarstefano, H. H. Bühlhoff, and A. Franchi, “Aggressive maneuver regulation of a quadrotor UAV,” in *16th Int. Symp. on Robotics Research*, ser. *Tracts in Advanced Robotics*, Singapore: Springer, Dec. 2013.
- Ch1** J. Lächele, A. Franchi, H. H. Bühlhoff, and P. Robuffo Giordano, “Swarmsimx: Real-time simulation environment for multi-robot systems,” in *3rd Int. Conf. on Simulation, Modeling, and Programming for Autonomous Robots*, ser. *Lecture Notes in Computer Science*, I. Noda, N. Ando, D. Brugali, and J. Kuffner, Eds., vol. 7628, Springer, 2012, pp. 375–387.

Submitted Conference Papers

- C61** A. Franchi, R. Carli, D. Bicego, and M. Ryll, “Full-pose geometric tracking control on $SE(3)$ for laterally bounded fully-actuated aerial vehicles,” in Submitted to 55th IEEE Conf. on Decision and Control, Las Vegas, NV, Dec. 2016.
- C60** G. Michieletto, A. Cenedese, and A. Franchi, “Bearing rigidity theory in $SE(3)$,” in Submitted to 55th IEEE Conf. on Decision and Control, Las Vegas, NV, Dec. 2016.
- C59** M. Mohammadi, A. Franchi, D. Barcelli, and D. Prattichizzo, “Cooperative aerial tele-manipulation with haptic feedback,” in Submitted to 2016 IEEE/RSJ Int. Conf. on Intelligent Robots and Systems, Daejeon, South Korea, Oct. 2016.
- C58** M. Ryll, D. Bicego, and A. Franchi, “Mechanical design and control of FAST-Hex: A fully-actuated by synchronized tilting hexarotor,” in Submitted to 2016 IEEE/RSJ Int. Conf. on Intelligent Robots and Systems, Daejeon, South Korea, Oct. 2016.
- C57** F. Schiano, A. Franchi, D. Zelazo, and P. Robuffo Giordano, “A rigidity-based decentralized bearing formation controller for groups of quadrotor UAVs,” in Submitted to 2016 IEEE/RSJ Int. Conf. on Intelligent Robots and Systems, Daejeon, South Korea, Oct. 2016.
- C56** M. Tognon, A. Testa, E. Rossi, and A. Franchi, “Exploiting a passive tether for robust takeoff and landing on slopes: Methodology and experiments,” in Submitted to 2016 IEEE/RSJ Int. Conf. on Intelligent Robots and Systems, Daejeon, South Korea, Oct. 2016.
- C55** B. Yüksel, G. Buondonno, and A. Franchi, “Differential flatness and control of protocentric aerial manipulators with mixed rigid- and elastic-joints,” in Submitted to 2016 IEEE/RSJ Int. Conf. on Intelligent Robots and Systems, Daejeon, South Korea, Oct. 2016.
- C54** B. Yüksel, N. Staub, and A. Franchi, “Aerial robots with rigid/elastic-joint arms: Single-joint controllability study and preliminary experiments,” in Submitted to 2016 IEEE/RSJ Int. Conf. on Intelligent Robots and Systems, Daejeon, South Korea, Oct. 2016.

Accepted/Published Conference Papers

- C53** A. Carron, M. Todescato, R. Carli, A. Franchi, and L. Schenato, “Multi-robot localization via GPS and relative measurements in the presence of asynchronous and lossy communication,” in 15th European Control Conference, Aalborg, Denmark, 2016.
- C52** A. Petitti, A. Franchi, D. Di Paola, and A. Rizzo, “Decentralized motion control for cooperative manipulation with a team of networked mobile manipulators,” in 2016 IEEE Int. Conf. on Robotics and Automation, Stockholm, Sweden, May 2016.
- C51** S. Spedicato, A. Franchi, and G. Notarstefano, “From tracking to robust maneuver regulation: An easy-to-design approach for VTOL aerial robots,” in 2016 IEEE Int. Conf. on Robotics and Automation, Stockholm, Sweden, May 2016.
- C50** A. Franchi, A. Petitti, and A. Rizzo, “Decentralized parameter estimation and observation for cooperative mobile manipulation of an unknown load using noisy measurements,” in 2015 IEEE Int. Conf. on Robotics and Automation, Seattle, WA, May 2015, pp. 5517–5522.
- C49** G. Gioioso, M. Mohammadi, A. Franchi, and D. Prattichizzo, “A force-based bilateral teleoperation framework for aerial robots in contact with the environment,” in 2015 IEEE Int. Conf. on Robotics and Automation, Seattle, WA, May 2015, pp. 318–324.

- C48** S. Rajappa, M. Ryll, H. H. Bühlhoff, and A. Franchi, “Modeling, control and design optimization for a fullyactuated hexarotor aerial vehicle with tilted propellers,” in 2015 IEEE Int. Conf. on Robotics and Automation, Seattle, WA, May 2015, pp. 4006–4013.
- C47** N. Staub and A. Franchi, “Battery-aware dynamical modeling and identification for the total thrust in multirotor uavs using only an onboard accelerometer,” in 2015 IEEE Int. Conf. on Robotics and Automation, Seattle, WA, May 2015, pp. 3341–3346.
- C46** M. Tognon and A. Franchi, “Control of motion and internal stresses for a chain of two underactuated aerial robots,” in 14th European Control Conference, Linz, Austria, Jul. 2015, pp. 1614–1619.
- C45** —, “Nonlinear observer for the control of bi-tethered multi aerial robots,” in 2015 IEEE/RSJ Int. Conf. on Intelligent Robots and Systems, Hamburg, Germany, Sep. 2015, pp. 1852–1857.
- C44** —, “Nonlinear observer-based tracking control of link stress and elevation for a tethered aerial robot using inertial-only measurements,” in 2015 IEEE Int. Conf. on Robotics and Automation, Seattle, WA, May 2015, pp. 3994–3999.
- C43** B. Yüksel, S. Mahboubi, C. Secchi, H. H. Bühlhoff, and A. Franchi, “Design, identification and experimental testing of a light-weight flexible-joint arm for aerial physical interaction,” in 2015 IEEE Int. Conf. on Robotics and Automation, Seattle, WA, May 2015, pp. 870–876.
- C42** D. Zelazo, P. Robuffo Giordano, and A. Franchi, “Bearing-only formation control using an SE(2) rigidity theory,” in 54rd IEEE Conf. on Decision and Control, Osaka, Japan, Dec. 2015.
- C41** A. Franchi, A. Petitti, and A. Rizzo, “Distributed estimation of the inertial parameters of an unknown load via multi-robot manipulation,” in 53rd IEEE Conf. on Decision and Control, Los Angeles, CA, Dec. 2014, pp. 6111–6116.
- C40** M. Gagliardi, G. Oriolo, H. H. Bühlhoff, and A. Franchi, “Image-based road network clearing without localization and without maps using a team of UAVs,” in 13th European Control Conference, Strasbourg, France, Jun. 2014, pp. 1902–1908.
- C39** G. Gioioso, A. Franchi, G. Salvietti, S. Scheggi, and D. Prattichizzo, “The Flying Hand: A formation of uavs for cooperative aerial tele-manipulation,” in 2014 IEEE Int. Conf. on Robotics and Automation, Hong Kong, China, May 2014, pp. 4335–4341.
- C38** G. Gioioso, M. Ryll, D. Prattichizzo, H. H. Bühlhoff, and A. Franchi, “Turning a near-hovering controlled quadrotor into a 3D force effector,” in 2014 IEEE Int. Conf. on Robotics and Automation, Hong Kong, China, May 2014, pp. 6278–6284.
- C37** C. Masone, P. Robuffo Giordano, H. H. Bühlhoff, and A. Franchi, “Semi-autonomous trajectory generation for mobile robots with integral haptic shared control,” in 2014 IEEE Int. Conf. on Robotics and Automation, Hong Kong, China, May 2014, pp. 6468–6475.
- C36** P. Stegagno, M. Basile, H. H. Bühlhoff, and A. Franchi, “A semi-autonomous UAV platform for indoor remote operation with visual and haptic feedback,” in 2014 IEEE Int. Conf. on Robotics and Automation, Hong Kong, China, May 2014, pp. 3862–3869.
- C35** P. Tokekar, V. Isler, and A. Franchi, “Multi-target visual tracking with UAVs,” in 2014 IEEE/RSJ Int. Conf. on Intelligent Robots and Systems, Chicago, IL, Sep. 2014.
- C34** B. Yüksel, C. Secchi, H. H. Bühlhoff, and A. Franchi, “A nonlinear force observer for quadrotors and application to physical interactive tasks,” in 2014 IEEE/ASME Int. Conf. on Advanced Intelligent Mechatronics, Besançon, France, Jul. 2014, pp. 433–440.

- C33** —, “Reshaping the physical properties of a quadrotor through IDA-PBC and its application to aerial physical interaction,” in 2014 IEEE Int. Conf. on Robotics and Automation, Hong Kong, China, May 2014, pp. 6258– 6265.
- C32** D. Zelazo, A. Franchi, and P. Robuffo Giordano, “Rigidity theory in $SE(2)$ for unscaled relative position estimation using only bearing,” in 13th European Control Conference, Strasbourg, France, Jun. 2014, pp. 2703– 2708.
- C31** G. Antonelli, E. Cataldi, P. Robuffo Giordano, S. Chiaverini, and A. Franchi, “Experimental validation of a new adaptive control for quadrotors,” in 2013 IEEE/RSJ Int. Conf. on Intelligent Robots and Systems, Tokyo, Japan, Nov. 2013, pp. 2439–2444.
- C30** V. Grabe, M. Riedel, H. H. Bühlhoff, P. Robuffo Giordano, and A. Franchi, “The TeleKyb framework for a modular and extendible ROS-based quadrotor control,” in 6th European Conference on Mobile Robots, Barcelona, Spain, Sep. 2013, pp. 19–25.
- C29** C. Secchi, A. Franchi, H. H. Bühlhoff, and P. Robuffo Giordano, “Bilateral control of the degree of connectivity in multiple mobile-robot teleoperation,” in 2013 IEEE Int. Conf. on Robotics and Automation, Karlsruhe, Germany, May 2013.
- C28** R. Spica, P. Robuffo Giordano, M. Ryll, H. H. Bühlhoff, and A. Franchi, “An open-source hardware/software architecture for quadrotor UAVs,” in 2nd IFAC Work. on Research, Education and Development of Unmanned Aerial Systems, Compiègne, France, Nov. 2013.
- C27** P. Stegagno, M. Basile, H. H. Bühlhoff, and A. Franchi, “Vision-based autonomous control of a quadrotor UAV using an onboard RGB-D camera and its application to haptic teleoperation,” in 2nd IFAC Work. on Research, Education and Development of Unmanned Aerial Systems, Compiègne, France, Nov. 2013.
- C26** M. Cagnetti, P. Stegagno, A. Franchi, and G. Oriolo, “Two measurement scenarios for anonymous mutual localization in multi-UAV systems,” in 2nd IFAC Work. on Multivehicle Systems, Espoo, Finland, Oct. 2012.
- C25** M. Cagnetti, P. Stegagno, A. Franchi, G. Oriolo, and H. H. Bühlhoff, “3-D mutual localization with anonymous bearing measurements,” in 2012 IEEE Int. Conf. on Robotics and Automation, St. Paul, MN, May 2012, pp. 791– 798.
- C24** A. Franchi and P. Robuffo Giordano, “Decentralized control of parallel rigid formations with direction constraints and bearing measurements,” in 51st IEEE Conf. on Decision and Control, Maui, HI, Dec. 2012, pp. 5310–5317.
- C23** C. Masone, A. Franchi, H. H. Bühlhoff, and P. Robuffo Giordano, “Interactive planning of persistent trajectories for human-assisted navigation of mobile robots,” in 2012 IEEE/RSJ Int. Conf. on Intelligent Robots and Systems, Vilamoura, Portugal, Oct. 2012, pp. 2641–2648.
- C22** M. Riedel, A. Franchi, H. H. Bühlhoff, P. Robuffo Giordano, and H. I. Son, “Experiments on intercontinental haptic control of multiple UAVs,” in 12th Int. Conf. on Intelligent Autonomous Systems, Jeju Island, Korea, Jun. 2012, pp. 227–238.
- C21** C. Secchi, A. Franchi, H. H. Bühlhoff, and P. Robuffo Giordano, “Bilateral teleoperation of a group of UAVs with communication delays and switching topology,” in 2012 IEEE Int. Conf. on Robotics and Automation, St. Paul, MN, May 2012, pp. 4307–4314.
- C20** R. Spica, A. Franchi, G. Oriolo, H. H. Bühlhoff, and P. Robuffo Giordano, “Aerial grasping of a moving target with a quadrotor UAV,” in 2012 IEEE/RSJ Int. Conf. on Intelligent Robots and Systems, Vilamoura, Portugal, Oct. 2012, pp. 4985–4992.

- C19** D. Zelazo, A. Franchi, F. Allgöwer, H. H. Bühlhoff, and P. Robuffo Giordano, “Rigidity maintenance control for multi-robot systems,” in 2012 Robotics: Science and Systems, Sydney, Australia, Jul. 2012.
- C18** A. Franchi, H. H. Bühlhoff, and P. Robuffo Giordano, “Distributed online leader selection in the bilateral teleoperation of multiple UAVs,” in 50th IEEE Conf. on Decision and Control, Orlando, FL, Dec. 2011, pp. 3559–3565.
- C17** A. Franchi, C. Masone, H. H. Bühlhoff, and P. Robuffo Giordano, “Bilateral teleoperation of multiple UAVs with decentralized bearing-only formation control,” in 2011 IEEE/RSJ Int. Conf. on Intelligent Robots and Systems, San Francisco, CA, Sep. 2011, pp. 2215–2222.
- C16** A. Franchi, P. Robuffo Giordano, C. Secchi, H. I. Son, and H. H. Bühlhoff, “A passivity-based decentralized approach for the bilateral teleoperation of a group of UAVs with switching topology,” in 2011 IEEE Int. Conf. on Robotics and Automation, Shanghai, China, May 2011, pp. 898–905.
- C15** D. Lee, A. Franchi, P. Robuffo Giordano, H. I. Son, and H. H. Bühlhoff, “Haptic teleoperation of multiple unmanned aerial vehicles over the internet,” in 2011 IEEE Int. Conf. on Robotics and Automation, Shanghai, China, May 2011, pp. 1341–1347.
- C14** P. Robuffo Giordano, A. Franchi, C. Secchi, and H. H. Bühlhoff, “Bilateral teleoperation of groups of UAVs with decentralized connectivity maintenance,” in 2011 Robotics: Science and Systems, Los Angeles, CA, Jun. 2011.
- C13** —, “Experiments of passivity-based bilateral aerial teleoperation of a group of UAVs with decentralized velocity synchronization,” in 2011 IEEE/RSJ Int. Conf. on Intelligent Robots and Systems, San Francisco, CA, Sep. 2011, pp. 163–170.
- C12** H. I. Son, L. L. Chuang, A. Franchi, J. Kim, D. J. Lee, S. W. Lee, H. H. Bühlhoff, and P. Robuffo Giordano, “Measuring an operator’s maneuverability performance in the haptic teleoperation of multiple robots,” in 2011 IEEE/RSJ Int. Conf. on Intelligent Robots and Systems, San Francisco, CA, Sep. 2011, pp. 3039–3046.
- C11** H. I. Son, J. Kim, L. Chuang, A. Franchi, P. Robuffo Giordano, D. Lee, and H. H. Bühlhoff, “An evaluation of haptic cues on the tele-operator’s perceptual awareness of multiple UAVs’ environments,” in IEEE World Haptics Conference, Istanbul, Turkey, Jun. 2011, pp. 149–154.
- C10** P. Stegagno, M. Cagnetti, A. Franchi, and G. Oriolo, “Mutual localization using anonymous bearing-only measures,” in 2011 IEEE/RSJ Int. Conf. on Intelligent Robots and Systems, San Francisco, CA, Sep. 2011, pp. 469–474.
- C9** J. W. Durham, A. Franchi, and F. Bullo, “Distributed pursuit-evasion with limited-visibility sensor via frontier-based exploration,” in 2010 IEEE Int. Conf. on Robotics and Automation, Anchorage, AK, May 2010, pp. 3562–3568.
- C8** A. Franchi, G. Oriolo, and P. Stegagno, “On the solvability of the mutual localization problem with anonymous position measures,” in 2010 IEEE Int. Conf. on Robotics and Automation, Anchorage, AK, May 2010, pp. 3193–3199.
- C7** —, “Probabilistic mutual localization in multi-agent systems from anonymous position measures,” in 49th IEEE Conf. on Decision and Control, Atlanta, GA, Dec. 2010, pp. 6534–6540.
- C6** A. Franchi, P. Stegagno, M. Di Rocco, and G. Oriolo, “Distributed target localization and encirclement with a multi-robot system,” in 7th IFAC Symp. on Intelligent Autonomous Vehicles, Lecce, Italy, Sep. 2010.
- C5** F. Pasqualetti, A. Franchi, and F. Bullo, “On optimal cooperative patrolling,” in 49th IEEE Conf. on Decision and Control, Atlanta, GA, Dec. 2010, pp. 7153–7158.

- C4** A. Franchi, G. Oriolo, and P. Stegagno, “Mutual localization in a multi-robot system with anonymous relative position measures,” in 2009 IEEE/RSJ Int. Conf. on Intelligent Robots and Systems, St. Louis, MO, Oct. 2009, pp. 3974–3980.
- C3** A. Franchi, L. Freda, L. Marchionni, G. Oriolo, and M. Vendittelli, in 10th Int. Conf. on Intelligent Autonomous Systems, Baden-Baden, Germany, Jul. 2008, pp. 348–355.
- C2** A. Franchi, L. Freda, G. Oriolo, and M. Vendittelli, “A decentralized strategy for cooperative robot exploration,” in ACM International Conference Proceeding Series, Proceedings of the 1st international conference on Robot communication and coordination, vol. 318, Athens, Greece, Oct. 2007.
- C1** —, “A randomized strategy for cooperative robot exploration,” in 2007 IEEE Int. Conf. on Robotics and Automation, Rome, Italy, Apr. 2007, pp. 768–774.

Accepted/Published Workshop Papers

- W14** G. Gioioso, G. Salvietti, A. Franchi, M. Malvezzi, S. Scheggi, L. Meli, M. Ryll, H. H. Bühlhoff, and D. Prattichizzo, “The flying hand: A teleoperation framework for cooperative aerial grasping and transportation,” in Automatica.it 2014, Convegno Annuale dei Docenti e Ricercatori Italiani in Automatica, Bergamo, Italy, Sep. 2014.
- W13** A. Franchi, “Towards autonomous-collaborative and haptic-tele-operated UAVs with fully-onboard state estimation and physical interaction capabilities,” in 2013 IROS Work. on From Remotely-Controlled to Autonomous- Collaborative Robots, Tokyo, Japan, Nov. 2013.
- W12** G. Gioioso, A. Franchi, G. Salvietti, S. Scheggi, and D. Prattichizzo, “Hand driven UAV formation for cooperative grasping and transportation: The flying hand,” in RSS 2013 Work. on Aerial Mobile Manipulation, Berlin, Germany, Jun. 2013.
- W11** J. Lächele, M. Riedel, P. Robuffo Giordano, and A. Franchi, “Swarmsimx and telekyb: Two ros-integrated software frameworks for single- and multi-robot applications,” in Int. Work. on Towards Fully Decentralized Multi-Robot Systems: Hardware, Software and Integration, at 2013 IEEE Int. Conf. on Robotics and Automation, Karlsruhe, Germany, May 2013.
- W10** T. Nestmeyer, M. Riedel, J. Lächele, S. Hartmann, F. Botschen, P. Robuffo Giordano, and A. Franchi, “Interactive demo: Haptic remote control of multiple uavs with autonomous cohesive behavior,” in Int. Work. on Towards Fully Decentralized Multi-Robot Systems: Hardware, Software and Integration, at 2013 IEEE Int. Conf. on Robotics and Automation, Karlsruhe, Germany, May 2013.
- W9** T. Nestmeyer, P. Robuffo Giordano, and A. Franchi, “Human-assisted parallel multi-target visiting in a connected topology,” in 6th Int. Work. on Human-Friendly Robotics, Rome, Italy, Oct. 2013.
- W8** —, “Multi-target simultaneous exploration with continual connectivity,” in 2nd Int. Work. on Crossing the Reality Gap - From Single to Multi- to Many Robot Systems, at 2013 IEEE Int. Conf. on Robotics and Automation, Karlsruhe, Germany, May 2013.
- W7** P. Stegagno, M. Basile, H. H. Bühlhoff, and A. Franchi, “RGB-D based haptic teleoperation of UAVs with onboard sensors: Development and preliminary results,” in 2013 IROS Work. on Vision-based Closed-Loop Control and Navigation of Micro Helicopters in GPS-denied Environments, Tokyo, Japan, Nov. 2013.
- W6** A. Franchi, C. Masone, and P. Robuffo Giordano, “A synergetic high-level/reactive planning framework with application to human-assisted navigation,” in 2012 IEEE IROS Work. on Real-time Motion Planning: Online, Reactive, and in Real-time, Vilamoura, Portugal, Oct. 2012.

- W5** C. Masone, A. Franchi, H. H. Büthoff, and P. Robuffo Giordano, “Shared trajectory planning for human-in-the-loop navigation of mobile robots in cluttered environments,” in 5th Int. Work. on Human-Friendly Robotics, Bruxelles, Belgium, Oct. 2012.
- W4** M. Riedel, A. Franchi, H. H. Büthoff, and P. Robuffo Giordano, “Intercontinental haptic control and advanced supervisory interfaces for groups of multiple UAVs,” in 5th Int. Work. on Human-Friendly Robotics, Bruxelles, Belgium, Oct. 2012.
- W3** A. Franchi, “Decentralized bilateral aerial teleoperation of multiple UAVs - part I: A top-down perspective,” in RSS 2011 Work. on 3D Exploration, Mapping, and Surveillance with Aerial Robots, Los Angeles, CA, Jun. 2011.
- W2** C. Secchi, P. Robuffo Giordano, and A. Franchi, “Bilateral teleoperation of groups of mobile robots with timevarying topology,” in Automatica.it 2011, Convegno Annuale dei Docenti e Ricercatori Italiani in Automatica, Pisa, Italy, Sep. 2011. Page 6 HRD Report – Antonio Franchi
- W1** P. Robuffo Giordano, A. Franchi, H. I. Son, C. Secchi, D. Lee, and H. H. Büthoff, “Towards bilateral teleoperation of multi-robot systems,” in 3rd Int. Work. on Human-Friendly Robotics, Tübingen, Germany, Oct. 2010.

Invited Talks

- T37** *Fully Actuated Aerial Platforms for Aerial Manipulation: Design and Control*, Workshop on Aerial Manipulation at 2016 IEEE ICRA, Stockholm, Sweden , May-2016
- T36** *Decentralized Estimation and Control for Cooperative Mobile Manipulation*, DIAG, Sapienza University of Rome, Rome, Italy, April-2016
- T35** *Aerial Robotics in the Robotics and InteractionS (RIS) team at LAAS*, AIST-CNRS Workshop Brain Circulation Project , LAAS, Toulouse, France, March-2016
- T34** *Observer-based Control of the Motion of Tethered Aerial Robots with Regulated Link Stress*, ENAC, Toulouse, France, January-2016
- T33** *Fully Distributed Estimation and Control for Cooperative Manipulation with Mobile Robots*, Collective Robotics Session at JNRR 2015, Baie de Somme, France, October-2015
- T32** *Connectivity, Rigidity and Online Decentralized Maintenance Methods*, Workshop on On-line decision-making in multi-robot coordination at 2015 IROS, Hamburg, Germany, October-2015
- T31** *Observer-based Control of the Motion of Tethered Aerial Robots with Regulated Link Stress*, Workshop UAV at 2015 Innorobo, Lyon, France, July-2015
- T30** *A Robotic Testbed for Bilateral Shared Control of Multiple Aerial Robots: the Telekyb Platform*, 10th National Conference on Control Architectures of Robots, Lyon, France, June-2015
- T29** *Nonlinear Control and Observation Methods for Tethered Aerial Vehicles with Onboard-only Measurements*, Workshop on Aerial Robotics Manipulation and Load Transportation at 2015 ICRA, Seattle, USA, May-2015
- T28** *Control of Aerial Vehicles for Physical Interaction: Current Results and Future Perspectives*, Scientific workshop on Aerial Robotics at ONERA, Toulouse, France, October-2014
- T27** *Planning and distributing tasks for structure assembly by multiple aerial manipulators*, ICRA 2014 Workshop on Aerial Robots Physically Interacting with the Environment, Hong Kong, China, May-2014
- T26** *The bright side of drones: a perspective vision on civil and domestic flying robots.*, Max Planck Institute for Biological Cybernetics, Tübingen, Germany, January-2014

- T25** *Cooperative control, localization, and teleoperation of UAVs with onboard state estimation and physical interaction ability*, Department of Computer Science, Technische Universität München, Munich, Germany, November-2013
- T24** *The Aerial Robotics Testbed at the Autonomous Robotics and Human-Machine Systems group*, Institute of Industrial Technology, Samsung Heavy Industries, Daejeon, South Korea, November-2013
- T23** *Ongoing Results on UAV Teleoperation with Onboard RGB-D Sensors and Quadrotor Physical Interaction*, Interactive & Networked Robotics Lab, Seoul National University, Seoul, South Korea, November-2013
- T22** *RGB-D based Haptic Teleoperation of UAVs with Onboard Sensors: Development and Preliminary Results*, IROS 2013 Workshop: Vision-based Closed-Loop Control and Navigation of Micro Helicopters in GPS-denied Environments, Tokyo, Japan, November-2013
- T21** *Towards Autonomous-collaborative and Haptic-tele-operated UAVs with Fully-onboard State Estimation and Physical Interaction Capabilities*, IROS 2013 Workshop: From Remotely Controlled to Autonomous-Collaborative Robots, Tokyo, Japan, November-2013
- T20** *Control Issues for Autonomy and Interactivity in Decentralized Teams of Heterogeneous Robots: a Research Prospective*, Workshop Robotique at LAAS-CNRS, Toulouse, France, October-2013
- T19** *Towards Physically Interactive Flying Robots: Physical Action and Human Haptic Control with Micro Aerial Vehicles*, RSS 2013, 2nd Workshop on Resource-Efficient Integration of Perception, Control, and Navigation for Micro Air Vehicles (MAVs), Berlin, Germany, June-2013.
- T18** *Autonomy and Human Interaction in Multi-Robot Systems*, ICRA 2013 Workshop on Towards Fully Decentralized Multi-Robot Systems: Hardware, Software and Integration, Karlsruhe, Germany, May-2013.
- T17** *Autonomous Control and Human Interaction in Multiple Robots Systems*, Department of Computer Science, Technische Universität Darmstadt, Darmstadt, Germany, April-2013
- T16** *Decentralized control of multiple-robot systems*, 2013 EURON Robotic Forum, Multi-robot Exploration Workshop, Lyon, France, March-2013
- T15** *Shared Control of Multiple Mobile Robots*, Schools of Mechanical Engineering and Computer Science, University of Birmingham, Birmingham, United Kingdom, March-2013
- T14** *Control and Estimation for Decentralized Multi-robot Systems*, Heudiasyc - CNRS - Université de Technologie de Compiègne, Compiègne, France, November-2012
- T13** *Multiple-robot systems: Decentralized Control and Estimation with Diverse Topological Requirements*, Laboratoire d'Informatique, de Robotique et de Microélectronique de Montpellier - UM2+CNRS, Montpellier, France, October-2012
- T12** *Decentralized Control and Estimation in Multi-robot Systems with Diverse Topological Requirements*, Laboratoire d'Analyse et d'Architecture des Systèmes - CNRS, Toulouse, France, September-2012
- T11** *Motion Control and Haptic Intervention with Multiple Mobile Robots*, Department of Science and Methods for Engineering, University of Modena and Reggio Emilia, Reggio Emilia, Italy, June-2012.
- T10** *Multi-robot algorithms for coverage, localization, and control, with decentralized maintenance of global connectivity and haptic interaction*, Department of Computer Science, University of Minnesota, Minneapolis, MN, USA, May-2012.
- T9** *Modeling, Control, and Haptic Steering of Multi-robot Formations*, ICRA 2012 Workshop on Haptic Teleoperation of Mobile Robots: Theory, Applications and Perspectives, St. Paul, MN, USA, May-2012.

- T8** *Bilateral Teleoperation of Groups of Mobile Robots: from Fixed to Time-Varying Topology*, Department of Information Engineering, University of Siena, Siena, Italy, November-25-2011.
- T7** *Passivity-based Decentralized Bilateral Teleoperation of Groups of Mobile Robots with Fixed and Time-Varying Topology*, Center for Control, Dynamical-Systems, and Computation (CCDC), University of California, Santa Barbara, CA, USA, October-3-2011.
- T6** *Decentralized Bilateral Aerial Teleoperation of Multiple UAVs - Part I: a Top-Down Perspective*, RSS 2011 Workshop on 3D Exploration, Mapping, and Surveillance with Aerial Robots, Los Angeles, CA, July-2011
- T5** *Bilateral Teleoperation of Multiple UAVs*, Dipartimento di Informatica e Sistemistica, Università di Roma "La Sapienza", Roma, Italy, December-2010.
- T4** *Haptic Teleoperation of Multi-Robot Systems*, School of Electrical and Computer Engineering, Georgia Institute of Technology, Atlanta, GA, USA, December-2010.
- T3** *Towards Bilateral Teleoperation of Multi-Robot Systems*, 3rd Workshop for Young Researchers on Human-Friendly Robotics (HFR 2010), Tübingen, Germany, October-2010.
- T2** *Decentralized Methods for Cooperative Task Execution in Multi-robot Systems*, GRASP Lab, University of Pennsylvania, Philadelphia, PA, USA, May-2010.
- T1** *Decentralized strategies for multi-robot systems: from autonomous behavior to multimodal human interaction*, Max Planck Institute for Biological Cybernetics, Tübingen, Germany, January-2010

Chapter 2

Short Summary of the Research Activity

The goal of this chapter is to provide a quick and slim overview of the topics spanned by my research activity since its beginning (during my master thesis back in 2005) until the first half of 2016. The goal of this overview is to let an expert scientist be able to judge the breadth of the research activity in order to provide a report on the possible obtainment of the habilitation. Therefore, this overview is written as a structured collection of entry-points and is not meant to be exhaustive and fully explanatory of the technical details of each work. Furthermore each work is not put in perspective with respect to the state of the art. The interested reader is referred to the cited papers for a properly contextualized and exhaustive description of the each work.

In order to provide a temporal perspective of my research activity, Figure 2.1 shows a timeline of my academic career from the obtainment of the master degree until the end of the period covered by this summary.

2.1 Master Thesis in Electrical Engineering (Dec. 2005)

2.1.1 Multi-robot Exploration (I)

I did my master thesis within the *robotic group of the Sapienza University of Rome* lead by Giuseppe Oriolo and Alessandro De Luca (the latter was my lecturer in both the 'Automatic Control' and 'Robotics' classes). The title of my thesis was *Coordination and Communication Strategies for Multi-robot Exploration*. During my thesis I developed both theoretical and practical skills, especially in the field of multi-robot planning and software for robotics, respectively. Part of the results of my thesis have been also published in conference paper (Franchi et al. 2007b) presented at the IEEE ICRA 2007.

The exploration method stems from the parallelization of the single-robot SRT technique and is based on the randomized incremental generation of a collection of data structures called Sensor-based Random Trees (SRT), each representing a roadmap of an explored area with an associated safe region. Decentralized cooperation and coordination mechanisms are used to improve the exploration efficiency and to avoid conflicts. I kept on working on multi-robot exploration during my PhD, see next Sec. 2.2.1.

Right after the master graduation in Electronic Engineering (grade: 110/110 cum laude), I first worked as engineer in the same robotics lab and then in a business consulting company for about a year. At the end 2006 I quit that job in order to start my PhD studies.

Year	Quarter	Primary activity	Other activity	Section				
2005	IV	Master thesis defense		Section 2.1				
2006	I	Worker in a business consulting company						
	II							
	III							
	IV							
2007	I	PhD Student at Sapienza University of Rome...		Section 2.2				
	II							
	III							
	IV							
2008	I		PhD Student at Sapienza University of Rome...		Worker in an embedded system company	Section 2.2		
	II							
	III							
	IV							
2009	I	Visiting PhD student at University of California at Santa Barbara			Section 3.3			
	II	...PhD Student			Section 3.2			
	III							
	IV							
2010	I	Research Scientist at the Max Planck Institute for Biological Cybernetics (MPI-KYB)	PhD Thesis defense	Section 3.4				
	II							
	III							
	IV							
2011	I		Research Scientist at the Max Planck Institute for Biological Cybernetics (MPI-KYB)			Section 3.4		
	II							
	III							
	IV							
2012	I	Research Scientist at the Max Planck Institute for Biological Cybernetics (MPI-KYB)			Section 3.4			
	II							
	III							
	IV							
2013	I		Project Leader at MPI-KYB			Section 3.5		
	II							
	III							
	IV							
2014	I	Permanent CRNS Researcher at LAAS-CNRS		Section 3.6				
	II							
	III							
	IV							
2015	I		Permanent CRNS Researcher at LAAS-CNRS			Section 3.6		
	II							
	III							
	IV							
2016	I				Permanent CRNS Researcher at LAAS-CNRS			Section 3.6
	II							

Figure 2.1: Timeline of my academic career from the obtainment of the master degree. The last column shows the corresponding section in this chapter.

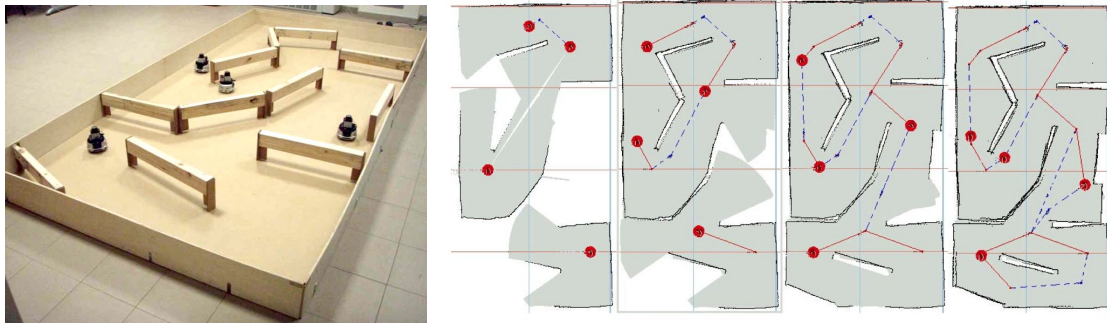

Figure 2.2: One of the experimental test of the SRG exploration method.

2.2 PhD Student in System Engineering at Sapienza University (Nov. 2006 – Feb. 2010)

In late 2006 I participated and won the public competitive examination for getting the grant for a PhD program in System Engineering in the robotic group of the Sapienza University of Rome. My PhD advisor has been Prof. Giuseppe Oriolo.

During the first part of my PhD I had several classes in the field of Control Theory (in particular ‘nonlinear control’ and ‘robust and adaptive control’, both thought by Alberto Isidori), Robotics, Optimization and Probability Theory. I also attended summer schools in Control, Robotics, Statistics and Riemannian Geometry, just to mention a few.

2.2.1 Multi-robot Exploration (II)

In the first year I significantly improved the exploration algorithm of my master thesis proposing an algorithm called Multi-SRG, (i.e., Multi Sensor-based Random Graph). The Multi-SRG method is a decentralized cooperative exploration strategy for mobile robots. A roadmap of the explored area, with the associate safe region, is built in the form of a compact data structure, called *Sensor-based Random Graph*. This is incrementally expanded by the robots by using a randomized local planner which automatically realizes a trade-off between information gain and navigation cost. Connecting structures, called bridges, are incrementally added to the graph to create shortcuts and improve the connectivity of the roadmap, see Figure 2.2. This new algorithm is described in (Franchi et al. 2007a).

At the same time I started to develop a robotic platform composed by 5 Khepera III (differentially driven mobile robots) equipped with HokuyoURG laser range finder, see Figure 2.3. In order to control in a distributed way each robot of the platform I developed a new software platform, that I called MIP (Multirobot Integrated Platform), <http://www.dis.uniroma1.it/~labrob/software/MIP/>, that I then used for implementing all the other multi-robot algorithm developed during my PhD. The first result of this work has been published and presented in (Franchi et al. 2008). The work on Multi-robot Exploration has been published in the **IEEE/ASME Transaction on Mechatronics** (Franchi et al. 2009) which summarizes and further extends all the results obtained at that time. [This paper is available in Appendix A](#). For this paper I won the IEEE RAS Italian Chapter Young Author Best Paper Award 2010.

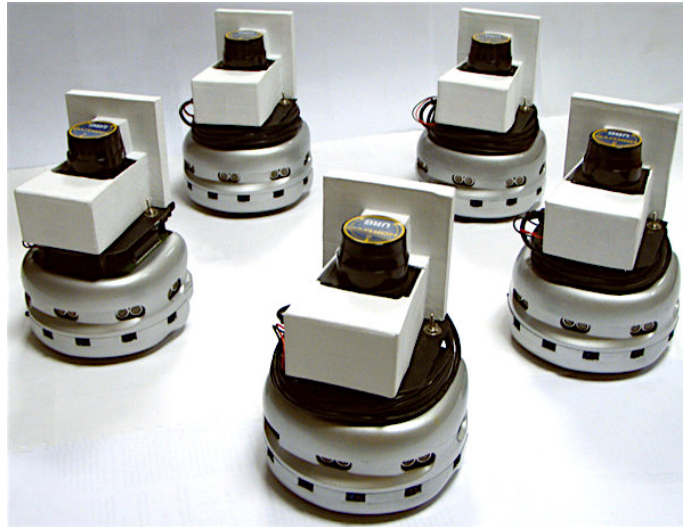

Figure 2.3: The robotic platform developed in 2006–2007 to test my multi-robot algorithms.

2.2.2 Mutual Localization with anonymous Relative Measurements

In the second year of my PhD I started to work on a new topic, still related to multi-robots, but from the localization point of view. My collaborator on this topic has been Paolo Stegagno, a student that I personally supervised since his master thesis, and also during his PhD. I have formulated and investigated a novel problem called Mutual Localization with Anonymous Position Measures. This is an extension of Mutual Localization with Position Measures, with the additional assumption that the identities of the measured robots are not known. For certain configurations of the multi-robot system, the anonymity hypothesis causes a combinatorial ambiguity in the inversion of the measure equation, resulting in the existence of multiple solutions.

In the works presented in (Franchi, Oriolo, and Stegagno 2009a; Franchi, Oriolo, and Stegagno 2009b) we have developed a two-phase filter for solving the anonymous localization problem. The first phase uses MultiReg, an innovative algorithm aimed at obtaining sets of geometrically feasible relative pose hypotheses. Then, its output is processed by a data associator and a multiple Extended Kalman Filter (EKF) to rate and select the best hypothesis. We have studied the performance of the developed localization system using both simulations and real experiments.

In (Franchi, Oriolo, and Stegagno 2010a), we have investigated more in the detail the structure of the problem. We have found a necessary and sufficient conditions for the uniqueness of the geometrical solution based on the notion of rotational symmetry in the physical plane. We have also derived the relationship between the number of robots and the number of possible solutions, and we have classified the solutions in a set of equivalence classes whose cardinality is linear with respect to the number of robots. Finally, we have developed a control law that effectively breaks symmetric formations so as to guarantee the unique solvability of the problem. We have demonstrated the performance of this control law through simulations.

In (Franchi, Oriolo, and Stegagno 2010b) we have modified the localization system in a probabilistic sense, first by using particle filters (rather than EKFs) to compute the current belief on the robots' relative poses, and then by modifying MultiReg so that it can use this information as a feedback.

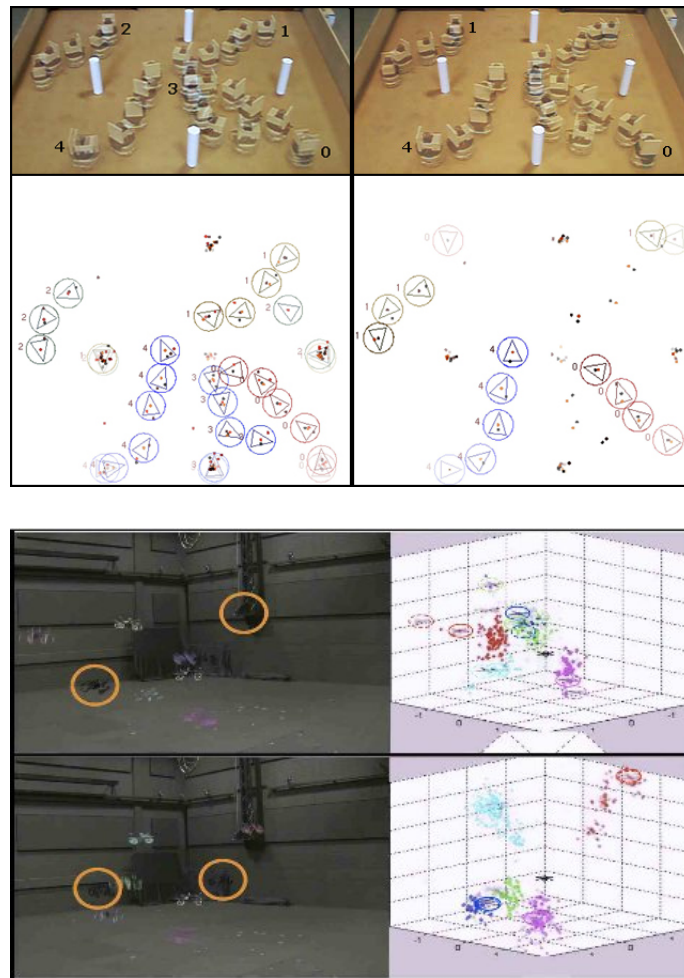

Figure 2.4: Experiments of the mutual localization method in the ground-robot and aerial-robot case.

This has several advantages, mainly (i) particle filters are intrinsically multi-modal and therefore do not require the use of heuristics for data association (ii) the new framework allows MultiReg to focus on solutions that are most likely according to the current belief, filtering out the effects of rotational symmetries that may arise in the system and avoiding the associated complexity increase. In practice, this results in a drastic reduction of the execution time whenever the task requires a rotational symmetric robot deployment (e.g., encirclement, escorting, etc). The proposed method had been experimentally validated.

A comprehensive summary of the whole work on anonymous mutual localization with relative position measurements has been published in **The International Journal of Robotics Research** (Franchi, Oriolo, and Stegagno 2013). [The paper is available in Appendix B.](#)

In (Stegagno et al. 2011; Cognetti et al. 2012a; Cognetti et al. 2012b) we have extended the method to the case where only bearing measurements are available (e.g., in the case the robots are equipped with a monocular camera). The extension holds both for the 2D (ground robots) and 3D (aerial robots) case.

Figure 2.4 shows real-robot experiments for both the ground- and the aerial-robot application of the developed algorithms.

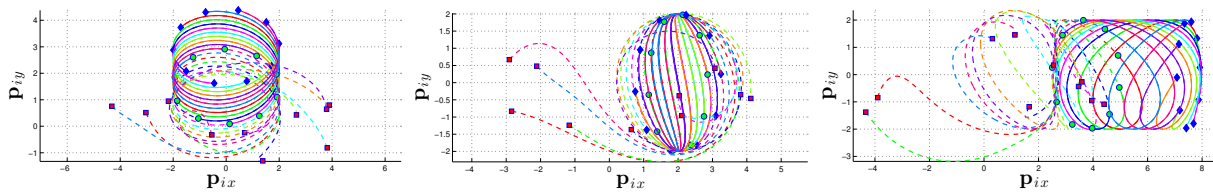

Figure 2.5: Examples of 3D trajectories generated by the decentralized encirclement control.

2.2.3 Calibration of the Kinematic Parameters with Onboard Sensors only

I parallel I also worked with Andrea Censi (now at MIT) to an algorithm that estimates simultaneously the six parameters of a differential drive equipped with a range sensor, i.e., wheel radii, wheel inter-distance, and laser roto-translation. the algorithm does not need a structured environment. We analyzed the observability of this problem and proposed a method for calibrating all parameters at the same time, without the need for external sensors or devices, using only the measurement of the wheels velocities and the data from the exteroceptive sensor. The method did not require the robot to move along particular trajectories. Simultaneous calibration was formulated as a maximum-likelihood problem and the solution was found in a closed form. Experimental results showed that the accuracy of the proposed calibration method is very close to the attainable limit given by the Cramèr—Rao bound. We published this method in the **IEEE Transaction on Robotics** (Censi et al. 2013). [This paper is available in Appendix E.](#)

2.2.4 Circular Formation Control and Object Tracking

Furthermore I also considered the problem of localizing and encircling a target using a multi-robot system. This kind of task is interesting in view of the large number of potential applications, e.g., observation (retrieve and merge data about an object from different viewpoints), escorting (protect a member of the system from unfriendly agents) and entrapment (prevent the motion of an alien object). In (Franchi et al. 2010) we presented a control scheme for achieving multi-robot encirclement in a distributed way, i.e., with each robot using only local information gathered by on-board relative-position sensors. In particular, these are assumed to be noisy, anisotropic, and unable to detect the identity of the measured object. Communication between the robots is provided by limited-range transceivers. We provided experimental results with stationary and moving targets to support the theoretical analysis.

Figures 2.5 and 2.6 illustrate some trajectories and experiments relative to the proposed method. The complete control algorithm, that has the ability to ensure also obstacle avoidance has been published on **Autonomous Robots** (Franchi, Stegagno, and Oriolo 2016). [This paper is available in Appendix F.](#)

2.2.5 Student Mentoring and PhD Thesis

During my PhD I directly supervised several students in their master theses, bachelor theses, and in small research projects.

The work conducted during the three years of PhD, has been organically collected in my PhD Thesis entitled “Decentralized Methods for Cooperative Task Execution in Multi-robot Systems”, completed at the end of 2009 and successfully defended in Feb. 2010.

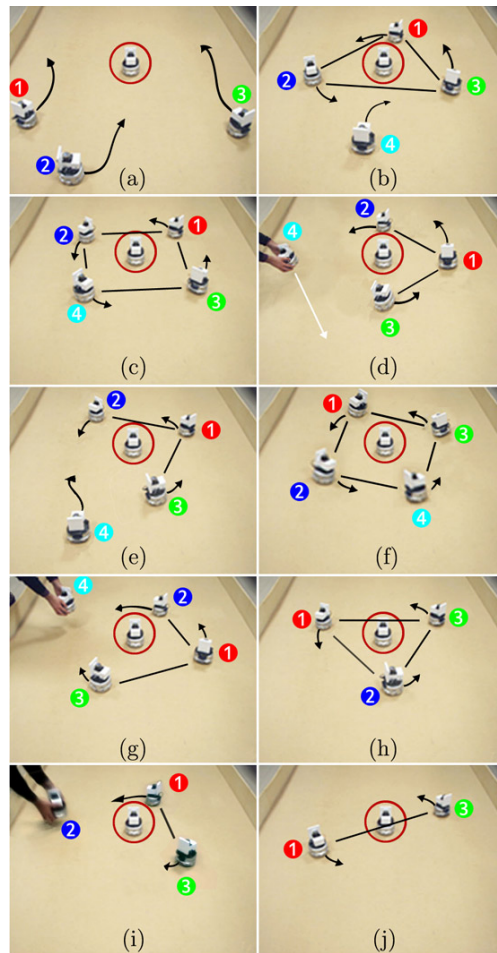

Figure 2.6: Experiments of the decentralized encirclement control with moving target and kidnapping.

2.3 Visiting PhD Student at University of California at Santa Barbara (Jan 2009 – July 2009)

During the third year of my PhD I have been visiting student at the University of California at Santa Barbara (UCSB), hosted in the lab of Prof. Francesco Bullo.

2.3.1 Persistent Monitoring

In cooperation with Fabio Pasqualetti (now at UC Riverside), I studied the problem of persistent monitoring, i.e., of designing optimal multi-agent trajectories to patrol an environment which is large w.r.t. the number of agents. Agents must continuously travel in order to periodically cover the whole environment but they can communicate with other agents only when they are “in visibility” and the inter-distance is small enough.

As performance criteria for optimal patrolling we considered the worst-case time gap between any two visits of the same region and the latency for a message to be transferred from any to any robot in the group. A first version of the proposed algorithm has been presented in (Pasqualetti, Franchi, and Bullo 2010), where we characterized the computational complexity of the trajectory design (patrolling)

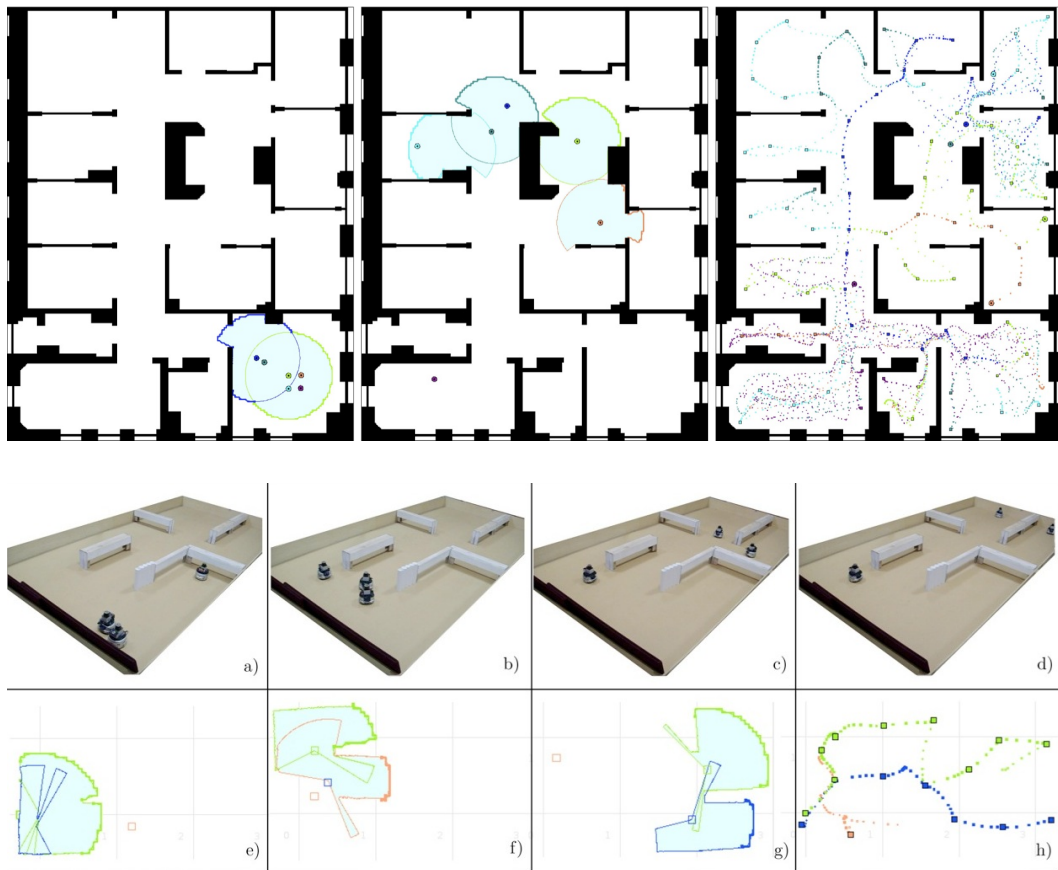

Figure 2.7: Simulations and experiments of the search without map method.

problem with respect to the environment topology and to the number of robots employed in the patrolling task. Even though the patrolling problem is generally NP-hard, We identified particular cases that are solvable efficiently, and we described optimal patrolling trajectories. Finally, we also presented a heuristic with performance guarantees, and an δ -approximation algorithm to solve the NP-hard patrolling problem.

An extension of those results has been published in the **IEEE Transactions on Robotics** (Pasqualetti, Franchi, and Bullo 2012), where also the case of a chain, tree, and cyclic graph have been studied separately. For the case of chain graph, we first described a minimum refresh time and latency team trajectory, and we proposed a polynomial time algorithm for its computation. Then, we described a distributed procedure that steers the robots toward an optimal trajectory. For the case of tree graph, a polynomial time algorithm has been developed for the minimum refresh time problem, under the technical assumption of a constant number of robots involved in the patrolling task. Finally, we showed that the design of a minimum refresh time trajectory for a cyclic graph is NP-hard, and we developed a constant factor approximation algorithm. [This paper is available in Appendix C.](#)

2.3.2 Decentralized Search without Map

During my visiting period at UCSB I also worked together with Joey Durham (now at Amazon Robotics, former Kiva Systems) on a distributed algorithm addressing the visibility-based search problem in which

one or more d-searchers with limited range sensors must coordinate to guarantee detection of any and all evaders in an unknown planar environment while using only local information.

The motivation was to develop algorithms to enable teams of robots to perform bomb or intruder detection and other related security tasks. A preliminary version of the algorithm has firstly been presented in a conference paper ([Durham, Franchi, and Bullo 2010](#)) and then the final version appeared on **Autonomous Robots** ([Durham, Franchi, and Bullo 2012](#)), ([paper available in Appendix D](#)). Figure 2.7 shows a real robot experiment performed in order to show the actual feasibility of the proposed algorithm.

The method it is built around guaranteeing complete coverage of the frontier between cleared and contaminated areas while expanding the cleared area. A novel approach to storing and updating the global frontier enables the algorithm to be truly distributed and to avoid using any kind of map and global localization method

Later, I further extended the developed search without-map method to the case of aerial robots equipped with down-facing cameras ([Gagliardi et al. 2014](#)).

2.4 Research Scientist: Max Plank Institute for Biol. Cybernetics (Jan. 2010 – Oct. 2012)

In January 2010 I was hired by Prof. H. H. Bülthoff as research scientist at the Max Plank Institute for Biological Cybernetics (MPI-KYB), and I started to work as associate leader of the Human-Robot Interaction Group. In this period I worked mainly in collaboration with Dr. Paolo Robuffo Giordano, the leader of the group.

During this period I addressed the problem of the interaction between humans and groups of robots whose local synergy is exploited to accomplish complex tasks. At the same time I kept on working on algorithms for controlling the motion of generic multi-robot systems. The interest on multi-robot systems came from the several advantages they possess w.r.t. single robots as, e.g., higher performance in simultaneous spatial domain coverage, better affordability as compared to a single/bulky system, robustness against single point failures.

As experimental multi-robot platform, we focused mainly to the case of group of aerial vehicles, because of their high motion flexibility and potential pervasivity in dangerous or unaccessible locations. We envisioned a scenario where the aerial vehicles possess some level of local autonomy and act as a group, e.g., by maintaining a desired formation, by avoiding obstacles, and by performing additional local tasks. At the same time, the remote human operator is in control of the overall motion of the aerial vehicles and receives, through haptic feedback, suitable cues informative enough of the remote aerial-vehicles/environment state. We addressed several possibilities for the human/single-multi-robot teleoperation which are recalled in the following. A high-level summary of the main concepts on this topic can be found in ([Franchi et al. 2012c](#)). Some experiments related to the shared control of multiple robots and the corresponding architecture are shown in Figures. 2.9 and 2.8, respectively.

2.4.1 Teleoperation of Multiple Aerial Robots with Fixed Topology

A first approach has been to consider the fixed-topology case (see ([Lee et al. 2013](#))) in which where the aerial vehicles are abstracted as 3-DoF first-order kinematic VPs (virtual points): the remote human

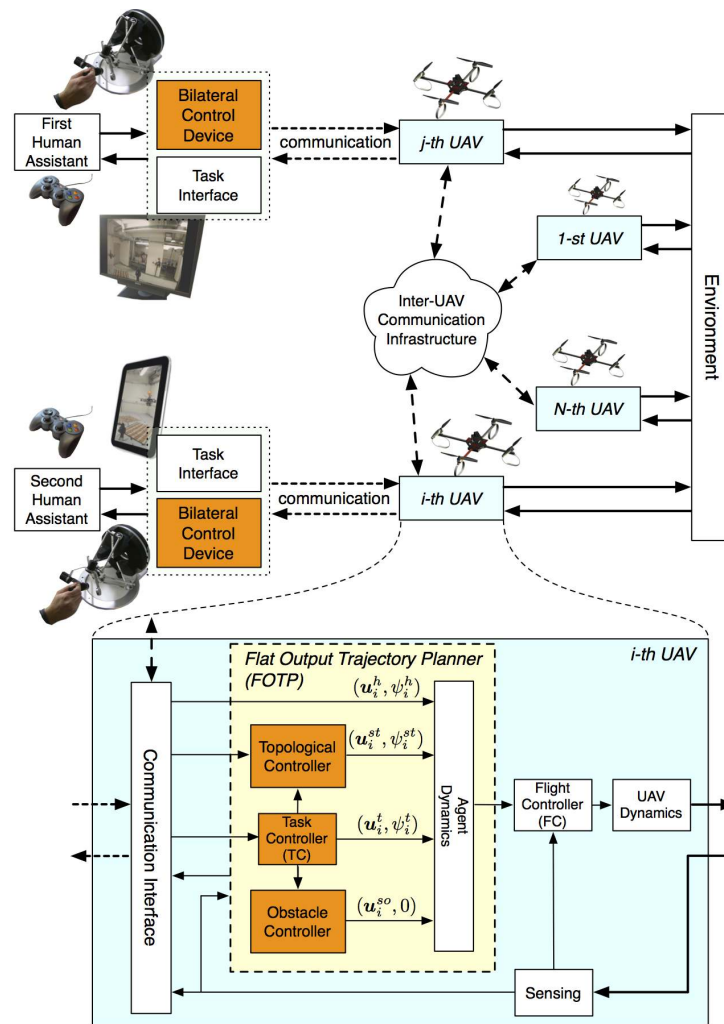

Figure 2.8: Architecture and overall framework of the shared control of multiple mobile robots.

user teleoperates a subset of the VPs, while the real robot position tracks the trajectory of its own VP. The VPs collectively move as an multi-nodes deformable flying object, whose shape (chosen beforehand) autonomously deforms, rotates and translates reacting to the presence of obstacles (to avoid them), and the operator commands (to follow them). The operator receives a haptic feedback informing him/her about the motion state of the real robots, and about the presence of obstacles via their collective effects on the VPs. Passivity theory is exploited to prove stability of the overall teleoperation system despite the delayed and unreliable internet connection.

The main results of this work have been published on the **IEEE/ASME Transaction on Mechatronics** (Lee et al. 2013). This paper is available in Appendix H. Figure 2.10-top illustrates some experiments based on this control strategy.

In (Riedel et al. 2012) we have tested this method with an experimental testbed for the intercontinental teleoperation and demonstrated its feasibility employing a communication channel going from Germany to South Korea.

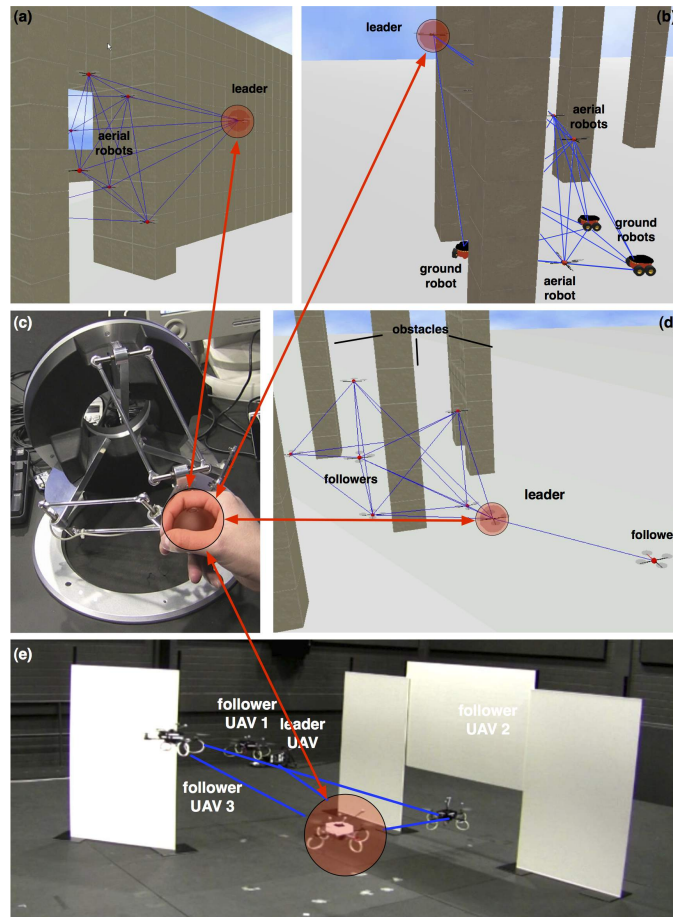

Figure 2.9: Simulations and experiments of shared control of multiple heterogeneous mobile robots.

2.4.2 Passivity-based control of Multiple Robots with Switching Topology

The time-varying topology approach has been firstly proposed in (Franchi et al. 2011) where the N robots (not necessarily all aerial vehicles) are abstracted as 3-DoF second-order VPs: the remote human user teleoperates a single leader, while the remaining followers motion is determined by local interactions (modeled as spring/damper couplings) among themselves and the leader, and repulsive interactions with the obstacles. The overall formation shape is not chosen beforehand but is a result of the motion of the robots. Split and rejoin decisions are allowed depending on any criterion, e.g., the robot relative distance and their relative visibility (i.e., when two robots are not close enough or obstructed by an obstacle, they split their visco-elastic coupling). The operator receives a haptic feedback informing him/her about the motion state of the leader which is also influenced by the motion of its followers and their interaction with the obstacles. The two-layer passivity-based approach is used to ensure stability of the overall teleoperation system. The main results of this work have been published on the **IEEE Transaction on Robotics** (Franchi et al. 2012a). This paper is available in Appendix I. Figure 2.10-bottom illustrates some experiments based on this control strategy.

An experimental validation of this approach approach has been also presented in (Robuffo Giordano et al. 2011b), where the decentralized velocity synchronization issue is also addressed while in (Franchi, Bühlhoff, and Robuffo Giordano 2011) an extension of the approach where the group autonomously

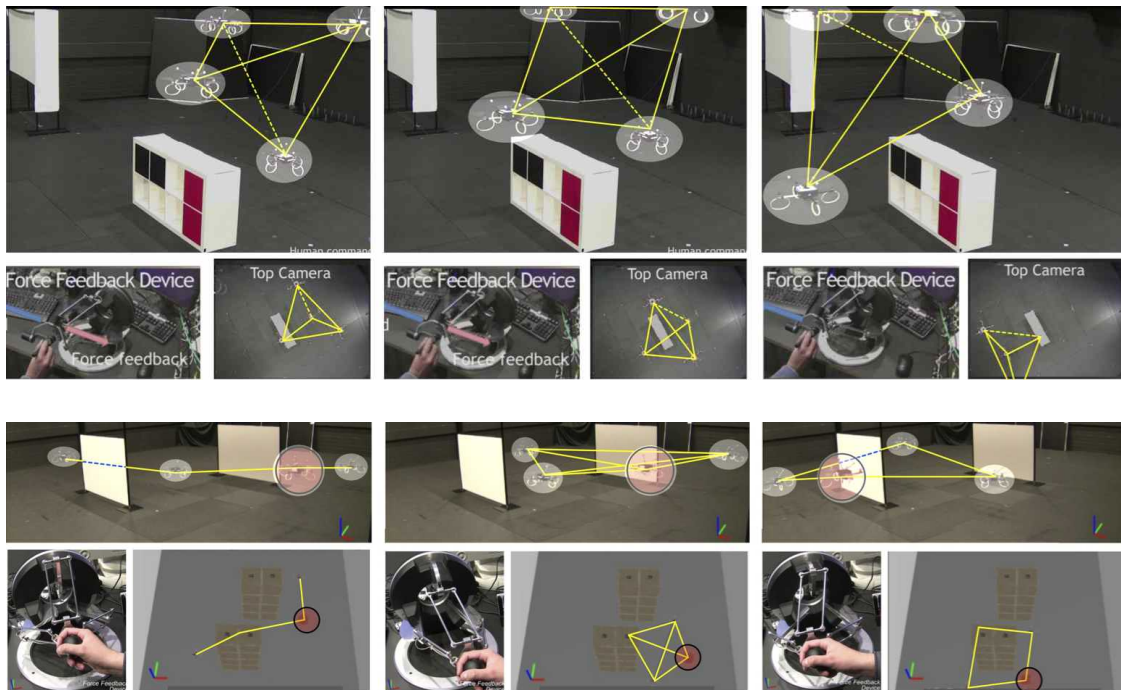

Figure 2.10: Experiments of shared control of multiple mobile robots. Fixed Topology versus time-varying topology case.

changes the leader in order to maximize the performances is presented. In (Secchi et al. 2012) the approach has been extended by explicitly consider the presence of time delays, both among the haptic device and the multi-robot system, and within the robots composing the multi-robot system.

2.4.3 Additional results on Shared Control with Haptic Feedback

Interactive planning The framework of bilateral shared control of mobile robots has been then extended with the aim of increasing the robot autonomy and decreasing the operator commitment. We considered persistent autonomous behaviors where a cyclic motion must be executed by the robot. The human operator is in charge of modifying online some geometric properties of the desired path. This is then autonomously processed by the robot in order to produce an actual path guaranteeing: i) tracking feasibility, ii) collision avoidance with obstacles, iii) closeness to the desired path set by the human operator, and iv) proximity to some points of interest. A force feedback is implemented to inform the human operator of the global deformation of the path rather than using the classical mismatch between desired and executed motion commands. The method has been first presented in (Masone et al. 2012) and further extended in (Masone et al. 2014).

Psychophysical evaluation In a work published on the *IEEE Transactions on Cybernetics* (Son et al. 2013) and in other works (Son et al. 2011a; Son et al. 2011b), I also collaborated to the investigation of the effect of haptic cueing on human operator’s performance in the field of bilateral teleoperation of multiple mobile robots, in particular multiple aerial vehicles.

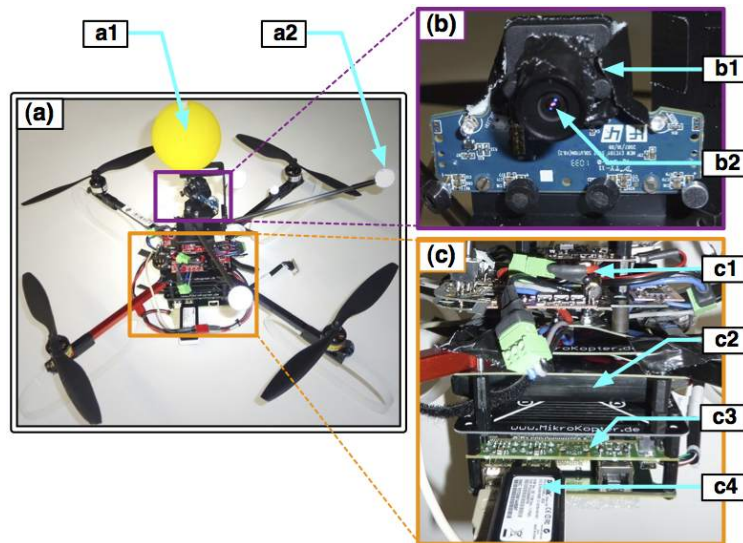

Figure 2.11: Quadrotor UAV developed for the experiments at MPI.

2.4.4 Vision-based Formation Stabilization

Another important research topic during my period at the MPI-KYB as research scientist has been the problem of controlling the motion of a group of UAVs bound to keep a formation defined in terms of only relative angles (i.e., a bearing-formation). This problem can naturally arise within the context of several multi-robot applications such as, e.g., exploration, coverage, and surveillance. In (Franchi et al. 2012b) we introduced and thoroughly analyzed the concept and properties of bearing-formations, and provided a class of minimally linear sets of bearings sufficient to uniquely define such formations. We then proposed a bearing-only formation controller requiring only bearing measurements, converging almost globally, and maintaining bounded inter-agent distances despite the lack of direct metric information. The controller still leaves the possibility to impose group motions tangent to the current bearing-formation. These can be either autonomously chosen by the robots to pursue any additional task (e.g., exploration), or exploited by an assisting human co-operator. Along this line an extension of this control strategy that make use of distributed estimation has been presented in (Franchi and Robuffo Giordano 2012). One of the platforms used to experimentally validate the method is shown in Figure 2.12. Additional explanations and illustrations are given in Section 3.5.3 and Figure 3.9.

The main results of this work have been published in **The International Journal of Robotics Research** (Franchi et al. 2012b). This paper is available in Appendix J.

2.4.5 Distributed Control Algorithms based on Generalized-Connectivity

An important part of my research has been to design decentralized controllers based on graph-theoretical methods in order to control a group of mobile robots while coping with the typical constraints of inter-robot sensing and communication. In the **RSS paper** (Robuffo Giordano et al. 2011a) we proposed a novel decentralized strategy able to enforce connectivity maintenance for a group of robots in a flexible way, that is, by granting large freedom to the group internal configuration so as to allow establishment/deletion of interaction links at anytime as long as global connectivity is preserved. A

peculiar feature of that approach was that we embedded into a unique connectivity preserving action a large number of constraints and requirements for the group: (i) presence of specific inter-robot sensing/communication models, (ii) group requirements such as formation control, and (iii) individual requirements such as collision avoidance. This is achieved by properly define the weights of the graph edges, by defining a suitable global potential function depending on the second smallest eigenvalue of the graph Laplacian, and by computing, in a decentralized way, a gradient-like controller built on top of this potential.

The main results of this work have been published on **The International Journal of Robotics Research** (**Robuffo Giordano et al. 2013**). [This paper is available in Appendix K.](#)

Some more details from the human-collaborative point of view can be found later in this document in Section 3.5.4. Figure 3.10 illustrates some experiments performed in order to test the proposed methods.

2.4.6 Rigidity-based Distributed Control Algorithms

Besides connectivity, another fundamental graph-theoretical concept is the one of rigidity, which is related to the ability to control a formation of robots (or to retrieve its geometric shape) only measuring a limited subset of inter-distances. In a **RSS paper** (**Zelazo et al. 2012**) we proposed a new index to measure the degree of rigidity of a group of robots that we called the *rigidity eigenvalue*. We then developed a decentralized control law that ensures the maintenance of the rigidity of the formation while allowing a dynamic change of the graph, similarly to the connectivity maintenance algorithm. Everything is done resorting only to local inter-distance measurements.

The main results of this work have been published on **The International Journal of Robotics Research** (**Zelazo et al. 2014**). [This paper is available in Appendix L.](#)

2.4.7 Student Mentoring and Participation in the Community

Student Mentoring

During my research scientist period at the MPI-KYB I supervised a one PhD student and several Master thesis students.

Participation in the community

In 2012 I was one of the organizers of the ICRA 2012 Workshop on “Haptic Teleoperation of Mobile Robots: Theory, Applications and Perspectives”. I also organized two events on intercontinental teleoperation of aerial vehicles at the 12th IAS and IEEE SMC 2012 conferences both in South Korea.

2.5 Project Leader: Autonomous Robotics and HMS Group at MPI (Nov. 2012 – Dec. 2013)

In November 2012 the leader of the Human-robot Interaction group left the MPI. I then proposed to the department administration, and obtained, to create a different group, called the “Autonomous Robotics and Human Machine Systems” group, and to be appointed leader of it. After about 6 months

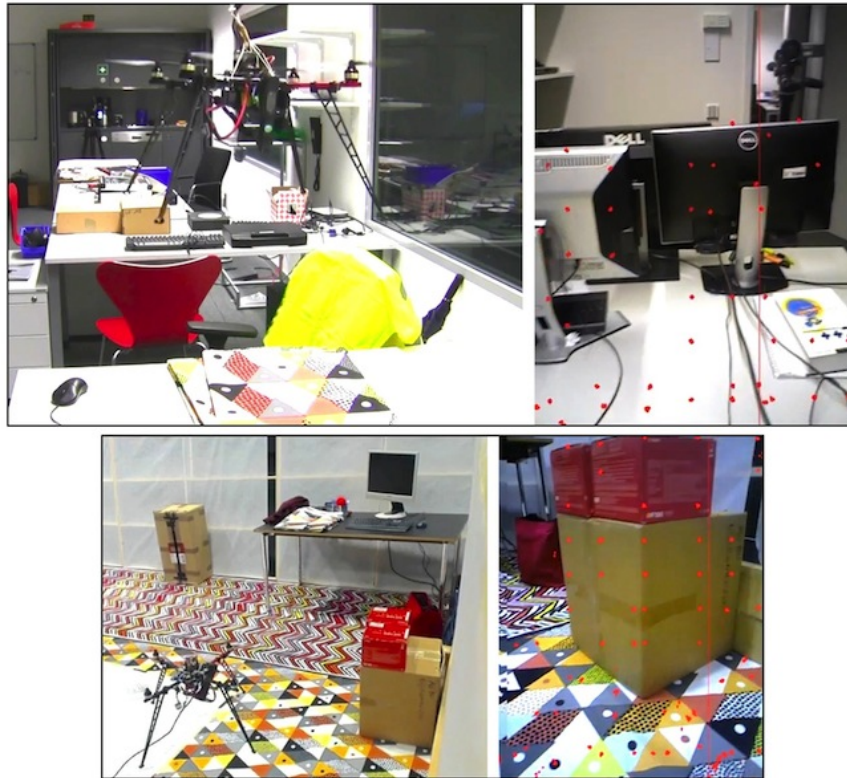

Figure 2.12: Semi-autonomous quadrotor that can be bilaterally teleoperated (i.e., with haptic feedback) by a remote user. The employed sensors are only the onboard RGB-D camera and IMU (no external motion capture is used).

from its constitution the new group counted about 10 members, among which, one postdoc, one fully supervised PhD student, 4 co-supervised PhD students, two engineers, three master students, and 2 undergraduate assistants.

With respect to the previous group I decided to keep the multi-robot research line but at the same time I diminished the focus in the human interaction aspects and replaced this axis with a research line on “physical interaction with aerial robots”, which at that time was, in my view, clearly emerging as a new and extremely promising research topic.

In parallel, I decided to develop a new experimental aerial robotic platform that could rely completely on onboard sensors, rather than making use of the motion capturing systems as it was with the existing one. Finally I also increased the interest of the group in finding novel control strategies for aerial robots also in the more classic case of contact-free flight.

2.5.1 Haptic Shared Control of Aerial Robots with Onboard Sensors Only

In order to investigate the use of haptic shared control with aerial vehicles using only onboard sensors, we developed the aerial platform shown in Figure 2.12.

Using this platform we tested a novel shared control strategy in which the human operator commands the desired forward velocity, the turning rate and the lift speed using a 3-DoF haptic interface. the haptic feedback is based on the distance measurements of the surrounding environment provided by the RGB-D

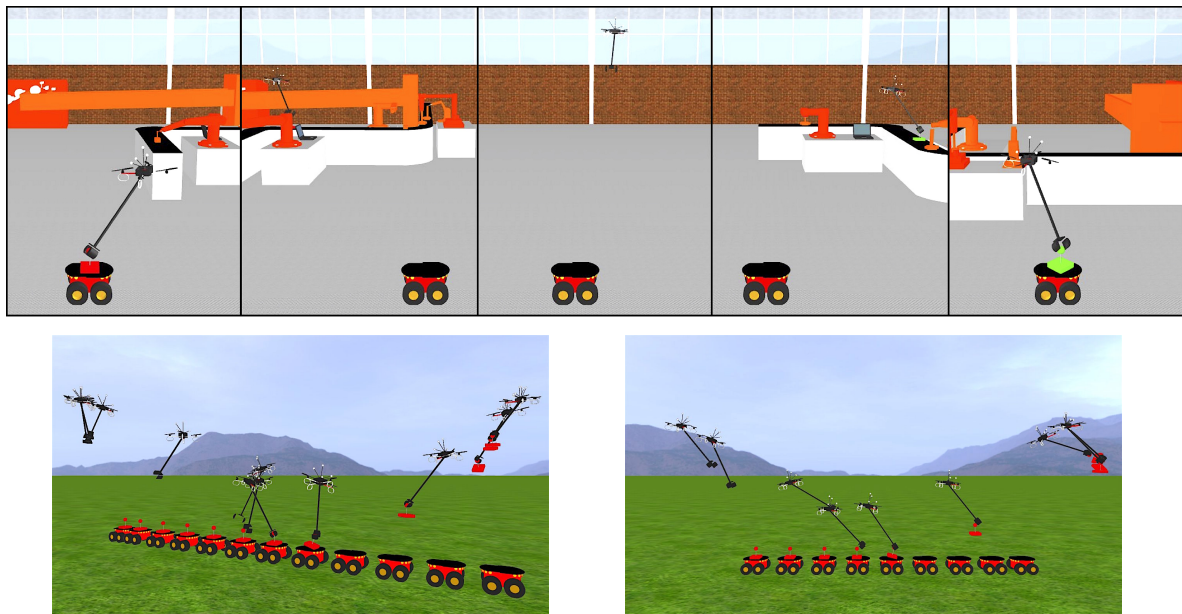

Figure 2.13: Dynamical simulations showing the planning strategy for allowing grasping of moving targets using an underactuated aerial robot equipped with a rigidly-attached gripper.

camera onboard. The robot autonomously estimates its own velocity using a photometric-error-based method. Furthermore, it automatically prevents the platform from colliding with the environment due to possible erroneous maneuvers of the the human operator. An automatic scanning of the environment is performed to overcome the limited field of view of the camera and it is automatically compensated in the video stream provided to the operator in order to provide him/her a virtually oscillation-free point of view. The method has been presented first in (Stegagno et al. 2013; Stegagno et al. 2014).

2.5.2 Control Aerial Robots in Contact-free Flight (I)

During this phase of my research career I started to concentrate more on novel strategies for control multi-rotor aerial systems.

Typically, multi-rotor system models assume a certain symmetry of the structure, such as the coincidence between the center of mass with the center of actuation of the propellers. In reality, the a priori knowledge of the exact center of mass of the platform is possible only with some error which can affect the performances of the control system. For this reason in (Antonelli et al. 2013) we developed an adaptive control law that can cope with the presence of this unknown parameter. Using the same strategy it is possible also to compensate for the presence of grasped loads and wind disturbances.

The most common approach used when automatically controlling aerial vehicles is to plan a trajectory (a path plus a time law) and to track it with a trajectory tracker. This yet powerful approach may be subject to some drawbacks in presence of sudden unexpected disturbances or in the case the planning does not (or cannot) properly take into account the actuation limits of the platform. In order to overcome these issues in (Spedicato et al. 2013) we proposed the use of a maneuver regulation strategy instead of a tracking one. We have shown how this strategy allows to robustify the tracking of the trajectory in presence of unexpected impediments to the motion or inaccuracies in the vehicle

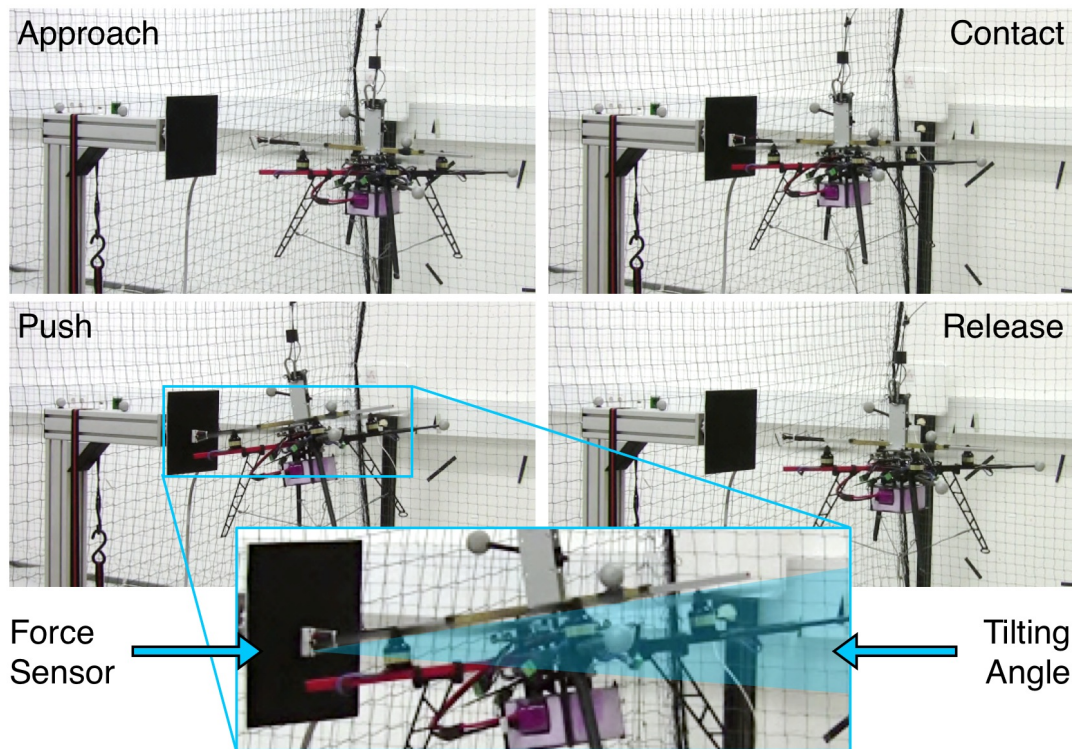

Figure 2.14: Experiments validating the controller of the force exerted by a quadrotor when using a rigid tool to physically interact with the environment.

model.

2.5.3 Planning & Control of Aerial Robots in Physical Contact (I)

As I mentioned before, the main new axis of research that I started with the new group was to contribute with novel algorithms for letting aerial robots deal with physical interaction. Classic control of aerial vehicles is designed for contact-free operation, and is not in general suited for physically interactive tasks, such as, pushing, inspecting, grasping, and manipulation.

In the first attempts in this direction ([Spica et al. 2012](#)) we studied the problem of planning a trajectory that connects two arbitrary states while allowing a quadrotor aerial vehicle to grasp a moving target at some intermediate time. We defined and characterized two classes of canonical grasping maneuvers. A planning strategy relying on differential flatness was then proposed to concatenate one or more grasping maneuvers by means of spline-based subtrajectories, with the additional objective of minimizing the total transfer time. The proposed planning algorithm is not restricted to pure hovering-to-hovering motions and takes into account practical constraints, such as the finite duration of the grasping phase. The effectiveness of the proposed approach has been shown by means of physically-based simulations. Figure 2.13 shows some simulations illustrating the developed methodology.

When considering physical interaction, one of the basic skills is the ability to apply a given 3D force against the environment in order, e.g., to push, pull, and lift an object. In ([Gioioso et al. 2014b](#)) we have shown how a standard near-hovering controlled multi-rotor vehicle can be turned into a 3D force

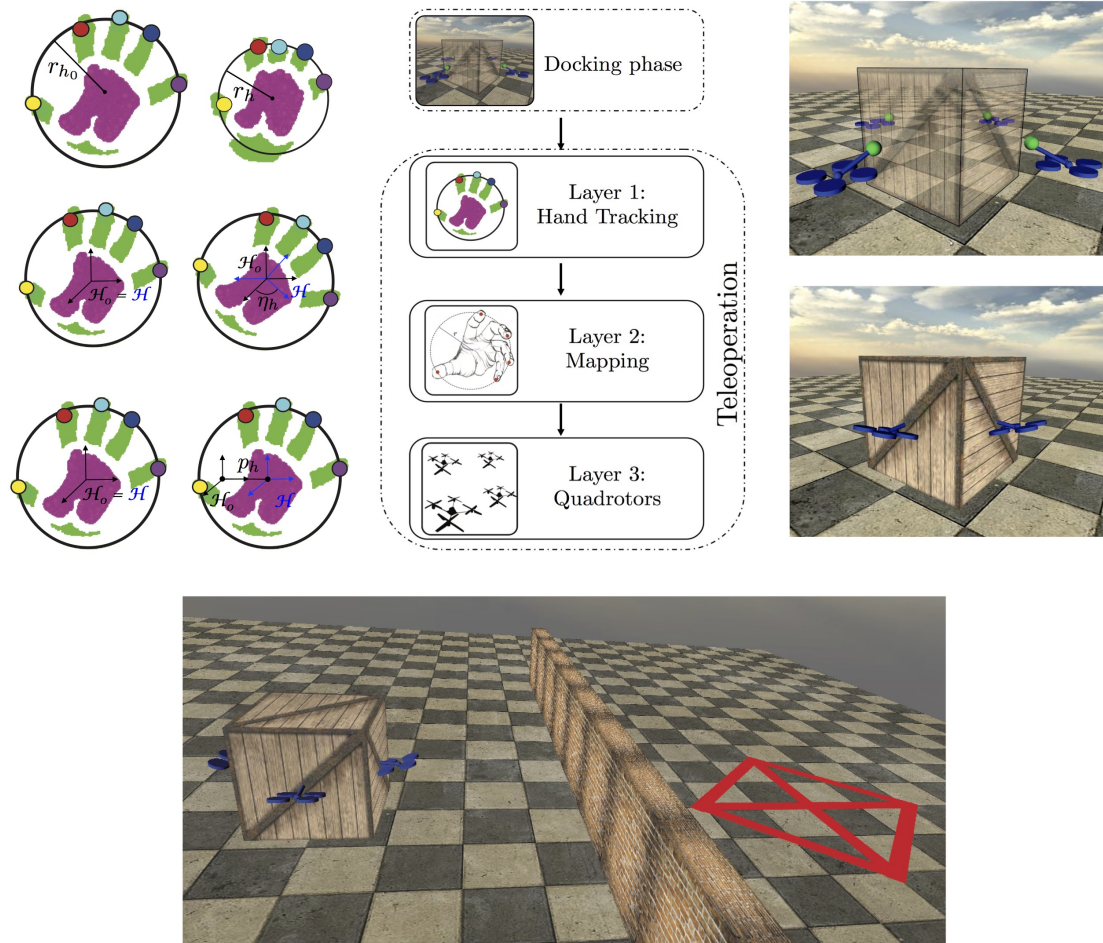

Figure 2.15: The Flying Hand concept: each quadrotor acts like a finger of a remote hand that can grasp large objects and can be, e.g., teleoperated by a human hand using gestures.

effector thus making it able to exactly track a desired profile of the force exerted on the environment. As it can be seen in Figure 2.14 we experimentally validated this method using a quadrotor platform equipped with a rigid tool and a special tip designed on purpose.

Once a single aerial vehicle is made capable to exert an arbitrary force on an object one can assimilate it to a flying finger. Composing several fingers we obtained then what we named the "flying hand" concept. A flying hand would consist of a group of several aerial robots that is able to transport and manipulate an object in the same way a large distributed hand would do it. This concept has been firstly illustrated in (Gioioso et al. 2014a). Figure 2.15 shows how this idea can be, e.g., integrated in a remote teleoperation scheme in which a human operator can teleoperate the whole team of robots using three abstraction layers. A block diagram of the algorithm is provided later in Figure 3.11.

A fundamental paradigm in interaction control for robots is the one in which the interface of the robot with the environment is made such that the robot resembles to a certain desired mechanical system from the input-output point of view. This is the paradigm behind, e.g., the impedance and admittance interaction control strategies. In (Yüksel et al. 2014b) we followed a similar paradigm in order to reshape the physical properties of a multi-rotor vehicle such as, e.g., its mass and damping.

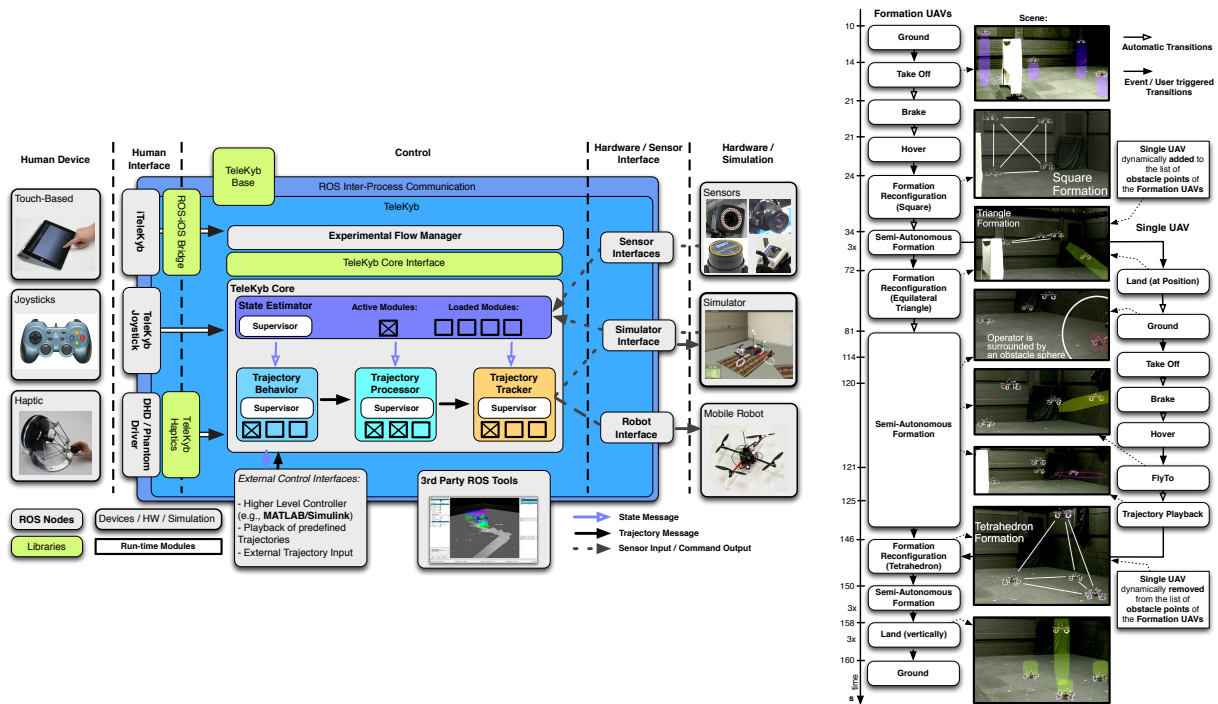

Figure 2.16: The TeleKyb software architecture allows a modular and extendible ROS-based control of single and multiple aerial robots with possible humans in the loop.

In order to do so we have employed a technique based on the interaction and damping assignment passivity based control. We have also shown how this kind of control strategy can be applied to aerial physical interactive tasks, such as, e.g., sliding for contact inspection.

A fundamental limitation of aerial robots is the often limiting payload. This comes with the fact that it is often impossible to equip an aerial robot with all the sensors that its ground counterpart could possess. Therefore it is of crucial importance to be able to estimate all the needed quantities with a limited amount of sensors. When it comes to control of the interaction, the measurement of the external force is often a requirement of the control scheme. However, force sensors are often heavy, expensive, and not available on small size aerial robots, for this reason in (Yüksel et al. 2014a) we developed a nonlinear force observer for multi-rotor systems and we have shown its application to physical interactive controllers such as the one proposed in (Yüksel et al. 2014b).

2.5.4 Hardware and Software for Aerial Robots

In the effort of testing the conceived control strategies we have developed both hardware platforms and software codes. When possible we have also tried to make this tools available to the community in the form of open-source hardware/software architectures.

Along this line, in (Spica et al. 2013) we propose an open-source hardware/software architecture for quadrotor vehicles. Several algorithms of general utility are made available for the calibration and estimation of the needed parameters and quantities, as well as basic control strategies.

In (Grabe et al. 2013) we have instead proposed the TeleKyb software framework (<http://wiki.ros.org/telekyb>) which allows a modular and extendible ROS-based control of single and multiple

aerial robots with possible human in the loop. Figure 2.16 shows the Telekyb software architecture and its application to the control of a team of multiple flying robots.

2.5.5 Student Mentoring and Participation in the Community

Student Mentoring

During the 14 months spent at the MPI-KYB as project leader of the autonomous robotics and human machine-systems group, I supervised a team that in average was made by about **8 to 9 members**, including one postdoc, 3 PhD students (directly or co-supervised) one engineer, two master students, and two undergraduate assistants.

Participation in the community

In this period, I co-organized the ICRA 2013 Workshop on “Towards Fully Decentralized Multi-Robot Systems: Hardware, Software and Integration”. I organized the technical tour of 2013 IEEE ICRA at the Max Planck Institutes in Tübingen and the demo on bi-operator haptic control of multiple aerial vehicles from the ICRA venue in Karlsruhe to the MPI-KYB in Tübingen.

In January 2013 I was appointed Associate Editor of the IEEE Robotics and Automation Magazine.

2.6 Permanent CNRS Researcher (CR1) at LAAS-CNRS (Jan. 2014 – Today 2016)

In March 2013 I participated and won the national public competition for the position of permanent researcher at CNRS (CR1). Even if I could have started in September 2013 I decided to postpone starting of my job at CNRS to January 2014, in order to better conclude the work with my team at MPI-KYB.

When I then started my work at LAAS-CNRS as permanent researcher I began to form a new group from the scratch with new members and new equipment. This process included the application for new sources of funding. Among others, the main funded projects that I was part of (and I am still part of) is the H2020 AeRoArms project <http://www.aeroarms-project.eu/> in which I am the LAAS Principal Investigator.

In parallel to the hiring of new people, from 2014 until now I managed the establishment of a new aerial robotics indoor testbed at LAAS, which was not present at the time I joined LAAS. This testbed is now equipped with a motion capture system, a small rapid prototyping workshop, and several robots, among which we have more than a dozen of multi-rotor aerial robots of several kinds which are used for different projects in parallel.

2.6.1 Control Aerial Robots in Contact-free Flight (II)

In this phase I kept on working on novel strategies for control multi-rotor aerial systems, as briefly illustrated in the following.

In (Staub and Franchi 2015) we have shown a new identification technique to learn the map between the pseudo-commands sent to each propeller (typically a PWM signal) and the total thrust

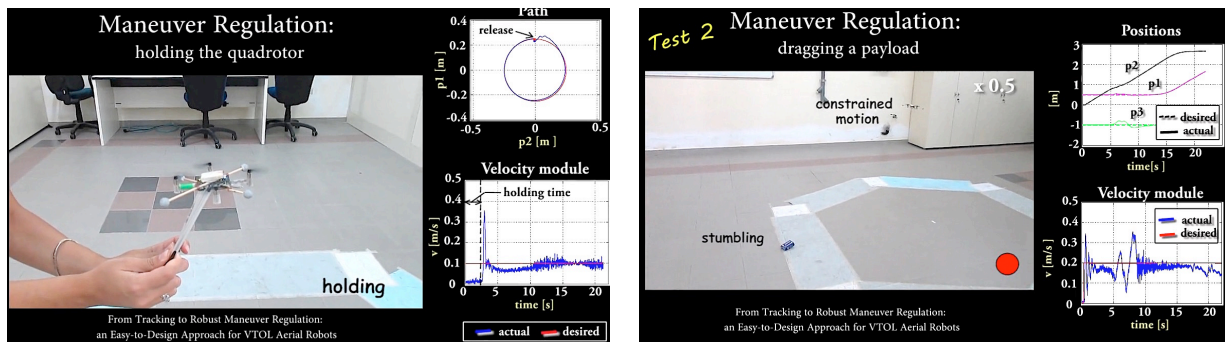

Figure 2.17: Experiments with a cm-scale aerial robot showing the robustness of the maneuver regulation approach (Spedicato, Franchi, and Notarstefano 2016) when the aerial robot is subject to unexpected external disturbances such as ‘holding’ (left) and ‘unknown payload dragging’ (right).

produced by the platform. The knowledge of this map is fundamental for the use of model-based estimation algorithm and for accurate tracking of trajectories. In particular we included in the map the knowledge of the battery voltage level, which is easily available onboard and has a non-negligible influence when pseudo-commands are used to drive the vehicle as, e.g., in standard low-end platforms. We have shown that the use of the sole measurements from an onboard accelerometer are enough for obtaining a model of the map whose accuracy is comparable with the one obtained with a post-processed data from a motion capture system.

Following up with the work presented in (Spedicato et al. 2013), in (Spedicato, Franchi, and Notarstefano 2016) we have shown how the maneuver regulation approach can be used as a plug-in to extend the functionality of any tracking control thus ensuring a robust implementation of the tracking. We have provided experimental validation of this technique with a nano-scale aerial vehicle subject to heavy unpredicted external disturbances, see Figure 2.17.

2.6.2 Planning & Control of Aerial Robots in Physical Contact (II)

In this period, kept on working on some novel control issues for aerial robots in physical contact with the environment, which are briefly summarized in the following.

Pushing and Cooperative Grasping

In (Gioioso et al. 2015) we have presented a force-based bilateral teleoperation framework for aerial robots exerting forces on the environment via pushing. An illustration of this concept is provided later in Section 3.4.5. An extension of this framework has been recently proposed in (Mohammadi et al. 2016) where we have followed up the flying hand concept introduced in (Gioioso et al. 2014a) in a much more complex and realistic scenario in which we considered, using an optimization approach, all the main constraints that appear in the aerial cooperative grasping transportation, such as: friction cones, actuation saturation, passive joint limits, object fragility, smoothness of the control. Figure 2.18 provides an illustration of the developed method.

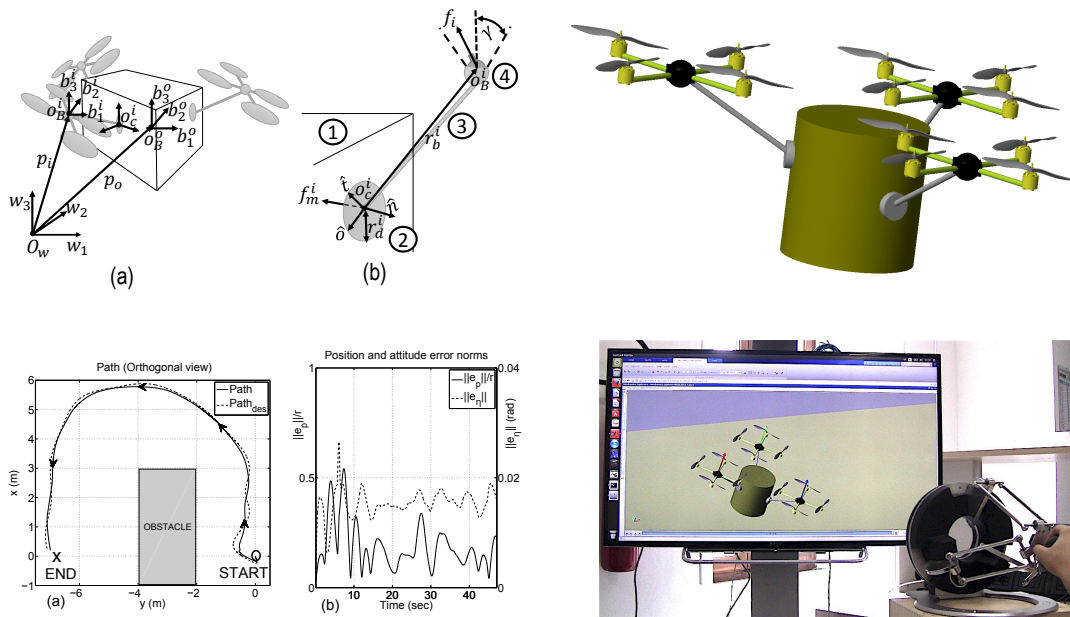

Figure 2.18: Human-in-the-loop simulations showing the developed cooperative aerial tele-manipulation control scheme. The robots perform a cooperative aerial grasping while taking into account all the main physical constraints of the system: joint limits, friction cones, maximum/minimum internal force, actuation limits, and smoothness of the control, to mention a few.

Control of Tethered Aerial Robots

A particularly relevant case of control of the physical interaction for aerial vehicles is the tethered aerial robot case. In the tethered case, a tether (typically a cable, but possibly any kind of link as, e.g., a bar) constrains the motion of the aerial robot on a lower dimensional subspace thus modifying the properties of the overall dynamical system. The use of tether for aerial robots can be beneficial, e.g., to improve stability in presence of external disturbances, to provide a mechanical coupling with a ground object in order to cooperate with or manipulate the object, to provide a mean for transportation, and to introduce new set of static equilibria for the aerial robot.

In our first work in this field (**Tognon and Franchi 2015b**) we have shown that both the position and the link stress (tension) can be stabilized independently along decoupled time-varying trajectories. Furthermore we have shown that this can be achieved resorting to a very minimal onboard sensorial equipment, i.e., a gyroscope and an accelerometer, using a nonlinear observer. Although quasi-static similar controllers have been proposed in the past for this system. At the best of our knowledge this has been the first controller working in the fully-dynamic case and also with minimal inertial sensing.

In a subsequent work we have shown that similar decoupling results apply also to a chain of tethered aerial robots (**Tognon and Franchi 2015a**) and that a nonlinear observer can be designed also in this case (**Tognon and Franchi 2015c**)

Then we have further extended these results to consider the case of an aerial robot tethered to a independently moving platform, and we have shown that also in this case it is possible to design an observer-based control of both the position and link tension. The latter work has been published on the **IEEE Robotics and Automation Letters** (**Tognon, Dash, and Franchi 2016**). *This paper is*

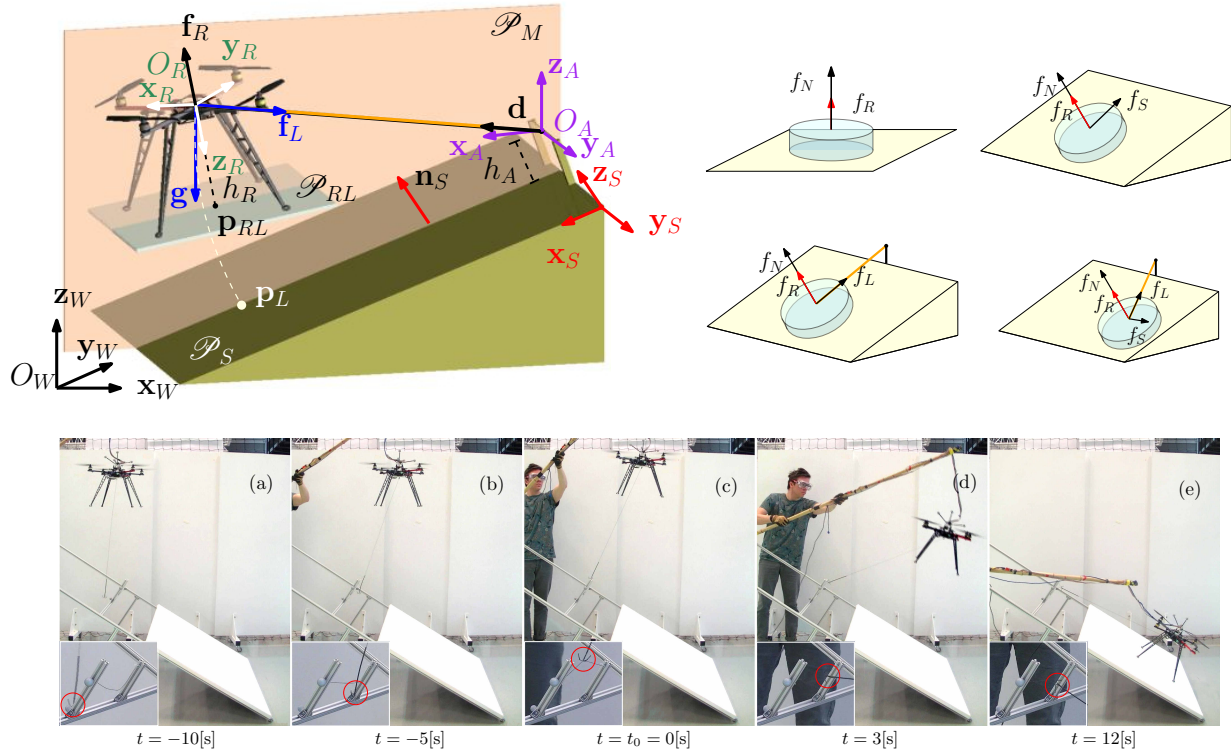

Figure 2.19: An experiment showing the use of the developed tethered control and planning methodology to robustly land on a sloped surface (perching).

available in [Appendix M](#).

Recently, in ([Tognon et al. 2016](#)), we have shown how passive tethers can be exploited to perform robust takeoff and landing on slopes (perching) without requiring precise exact tracking of very dynamic and almost open-loop maneuvers. Figure 2.19 illustrates the main concept proposed in this work.

2.6.3 Design, Modeling and Control of Novel Aerial Robots

In the last year I started also to work on the design, modeling and control of new sorts of aerial robots. In particular I directed my attention towards the case of aerial manipulators with possibly elastic-joint arms, and the case of fully- or redundantly actuated aerial vehicles, as briefly summarized in the following.

Aerial Manipulators with both Rigid- and Elastic-joint Arms

The study of aerial manipulators has received an huge increment of interest in the very recent years. The ability to perform mobile manipulation in any point the 3D environment opens a much wider set of applications but also comes with many design and control challenges.

In this field my group is among the first in studying the properties of elastic-joint arms mounted on floating (aerial) bases.

In ([Yüksel et al. 2015](#)) we have shown the design of a novel light-weight flexible-joint arm for aerial physical interaction, which is illustrated in Figure 2.20-(top, right). We have proposed an identification

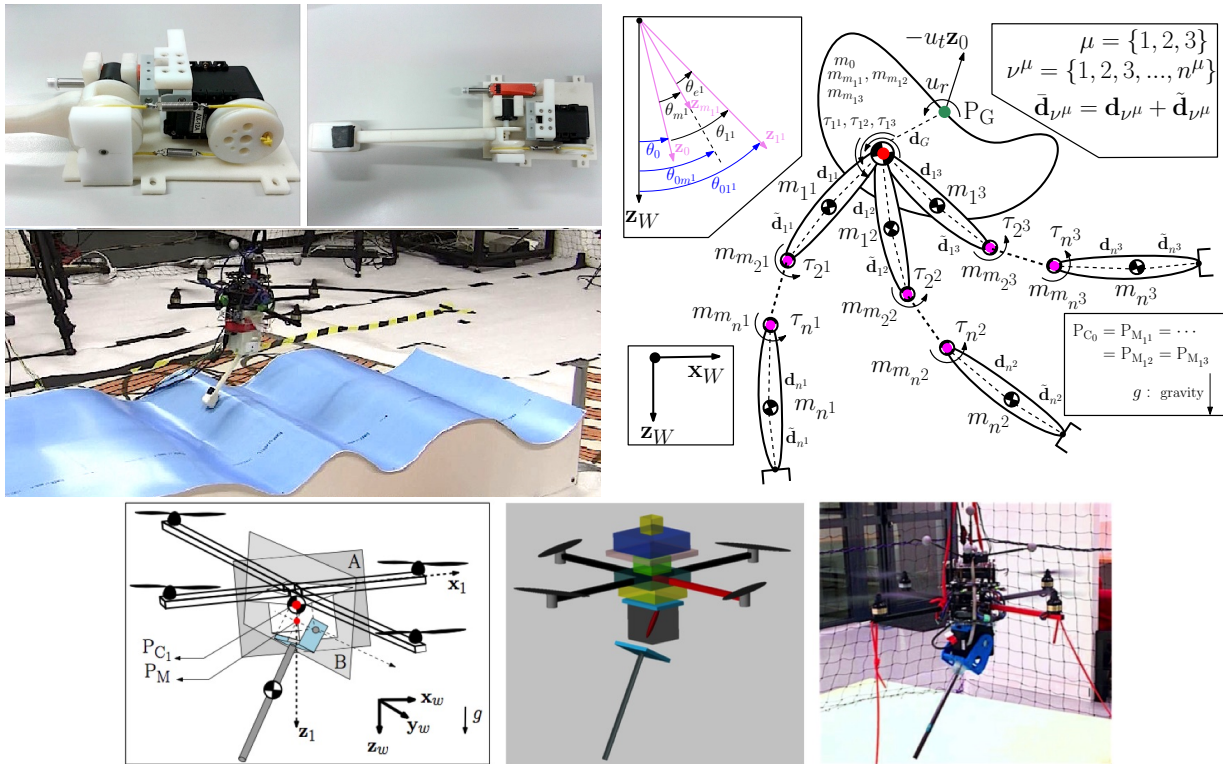

Figure 2.20: Experiments and kinematics of aerial manipulators with mixed rigid- elastic- joint arms. Top-left: a in-house developed elastic-joint arm for aerial manipulation. Bottom: a quadrotor equipped with a qbmove VSA elastic-joint from <http://www.qbrobotics.com/>.

method for the robot parameters and an experimental testing to assess the possible critic aspects of this kind of design. In (Yüksel, Staub, and Franchi 2016) and we have instead studied analytically the controllability properties of such systems and we have tested the proposed controller with a commercially available elastic joint that provides variable stiffness functionality, Figure 2.20-(bottom) illustrates the aerial robot in exam.

Recently, in (Yüksel, Buondonno, and Franchi 2016) we have generalized the previous results to the case of any number of manipulators and of mixed rigid- and elastic-joint arms. In particular we have proven the differential flatness property of the end-effector position for the so called “protocentric aerial manipulators”, i.e., aerial manipulators in which the first joint coincides with the center of mass of the aerial platform (but not necessarily with the geometric center of actuation of its propellers. An illustration of the kinematics of these kind of manipulators is shown in Figure 2.20-(top, right).

Fully-actuated Aerial Platforms

Typical aerial platforms are under-actuated, because, even in the case of six or more propellers, the rotors are all co-planar and therefore it is impossible to fully-decouple the body orientation from the higher order derivatives of the center of mass position trajectory.

In (Rajappa et al. 2015) we have presented the modeling, control and design optimization for a fully-actuated hexarotor aerial vehicle, the fully actuation is achieved by having non-coplanar (tilted) propellers. For this case input-output exact static linearization is possible. We have conducted also a

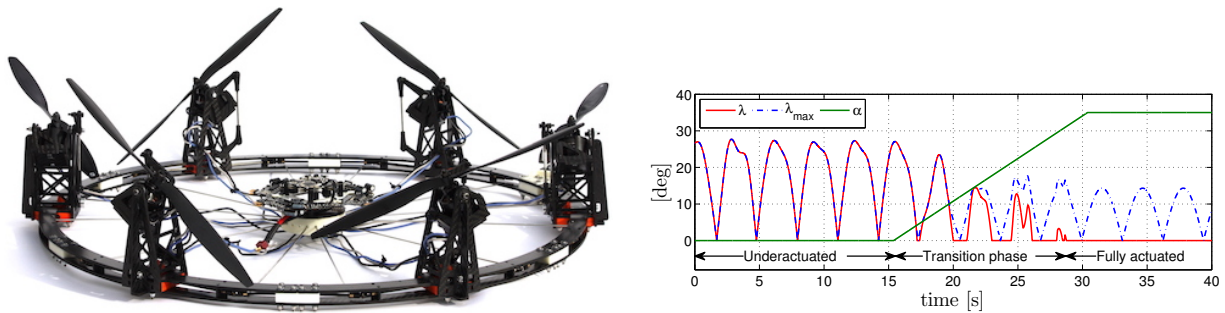

Figure 2.21: Left: one of the developed fully-actuated aerial prototypes. Right: smooth transition from under- to full-actuation.

study on the optimal choice of the tilting angles in function of the task.

The main drawback of an exact linearization approach for this platform is that it does not take into account the fact that the propellers can produce only a force whose intensity is positive and bounded. With small tilting angles, exact linearization may ask the propellers a huge or negative amount of force that is impossible to be produced. Recently, in (Franchi et al. 2016), we have proposed a completely new controller based on a geometric approach in $SE(3)$ that is able to naturally take into account the strict actuation bounds and allows a smooth transition from the under- to fully-actuated condition.

Still very recently, in (Ryll, Bicego, and Franchi 2016), we have proposed a novel mechanical design and fully-actuated by synchronized-tilting hexarotor that is able to switch between efficient (but underactuated) and fully-actuated (but less efficient) flight conditions with a minimal amount of motors. This novel platform is shown in Figure 2.21-left.

2.6.4 Decentralized Cooperative Manipulation: Estimation and Control

In parallel to the aerial robotics work I kept on working on multi-robot systems. The field of cooperative manipulation with multiple mobile robots has been deeply studied in the past. However, quite surprisingly, not so many approaches providing fully decentralized control strategies are available in the literature. Furthermore, the scarcity of existing solution becomes even more evident if the geometry of the grasping and the load parameters are considered unknown.

In some recent works, (Franchi, Petitti, and Rizzo 2014; Franchi, Petitti, and Rizzo 2015), we studied and solved the problem of estimating in a fully distributed way all the inertial parameters of an unknown load, all the parameters of the grasping, and the full state of the load by assuming that each robot only knows the local force applied to robot and the local velocity of its contact point, and it is able to communicate only with the neighbors in the communication network. The method is based on the manipulation kinematics and dynamics, and on a nonlinear observer. In (Petitti et al. 2016) we have designed a robust decentralized controller for the cooperative manipulation and we have shown how the previously described estimation method can be used to control the motion of the load with a distributed team of networked mobile manipulators. Figure 2.22 illustrates the problem and the block diagram of the proposed control architecture.

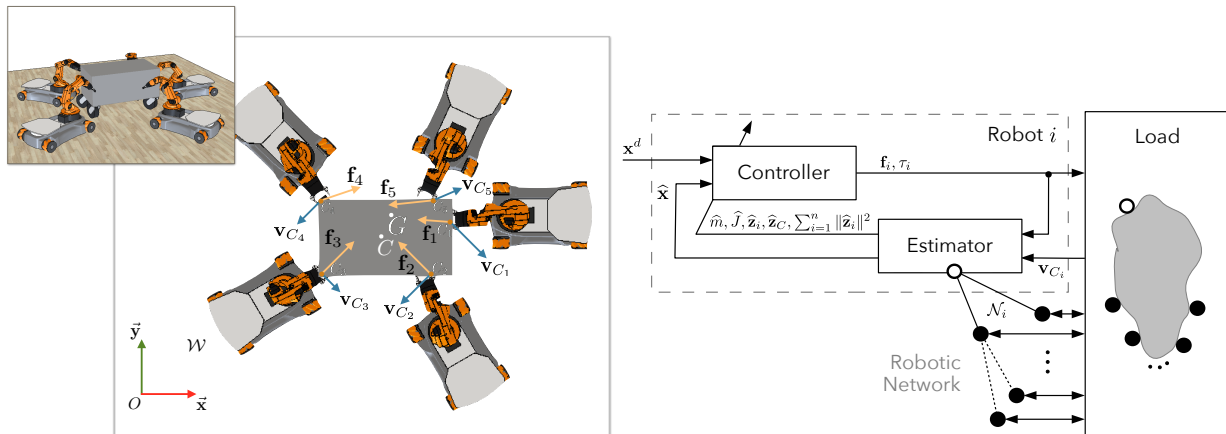

Figure 2.22: Fully-decentralized cooperative manipulation with unknown load parameters, unknown grasping parameters, and unknown load state.

2.6.5 Other Multi-robot Research Activities

Distributed Online Leader Selection

In a recent work, accepted for publication on the **IEEE Transactions on Control of Network Systems** (Franchi and Robuffo Giordano 2016), we proposed an extension of the popular leader-follower framework for multi-agent collective tracking and formation maintenance in presence of a time-varying leader. In particular, the leader is persistently selected online so as to optimize the tracking performance of an exogenous collective velocity command while also maintaining a desired formation via a (possibly time-varying) communication-graph topology. We analyzed the effects of a change in the leader identity and exploited this analysis for defining a suitable error metric able to capture the tracking performance of the multi-agent group, that is based on the properties of a special graph induced by the choice of the leader.

Rigidity of Multi-Robot Formations in SE(2) and SE(3)

A follow-up of the work on rigidity presented in Section 2.4.6 has been to extend the rigidity concept to non-Euclidian spaces that arise naturally when one considers the orientation of the robots and the bearing (angular) measurements instead of the distance one.

Along this line we have extended the rigidity control theory to SE(2) for the estimation of unscaled position (Zelazo, Franchi, and Robuffo Giordano 2014) and for the formation control (Zelazo, Robuffo Giordano, and Franchi 2015; Schiano et al. 2016) using only bearing measurements. Recently, we further extended the bearing rigidity theory to SE(3) (Michieletto, Cenedese, and Franchi 2016).

2.6.6 Student Mentoring and Participation in the Community

Student Mentoring

At date, I am managing a group of about **14 members**, including, one permanent CNRS engineer, one postdoc, 4 PhD students graduating at LAAS or MPI, 4 co-advised PhD students graduating outside of LAAS or MPI, 2 visiting PhD students, and 2 master students. My group is part of a larger team

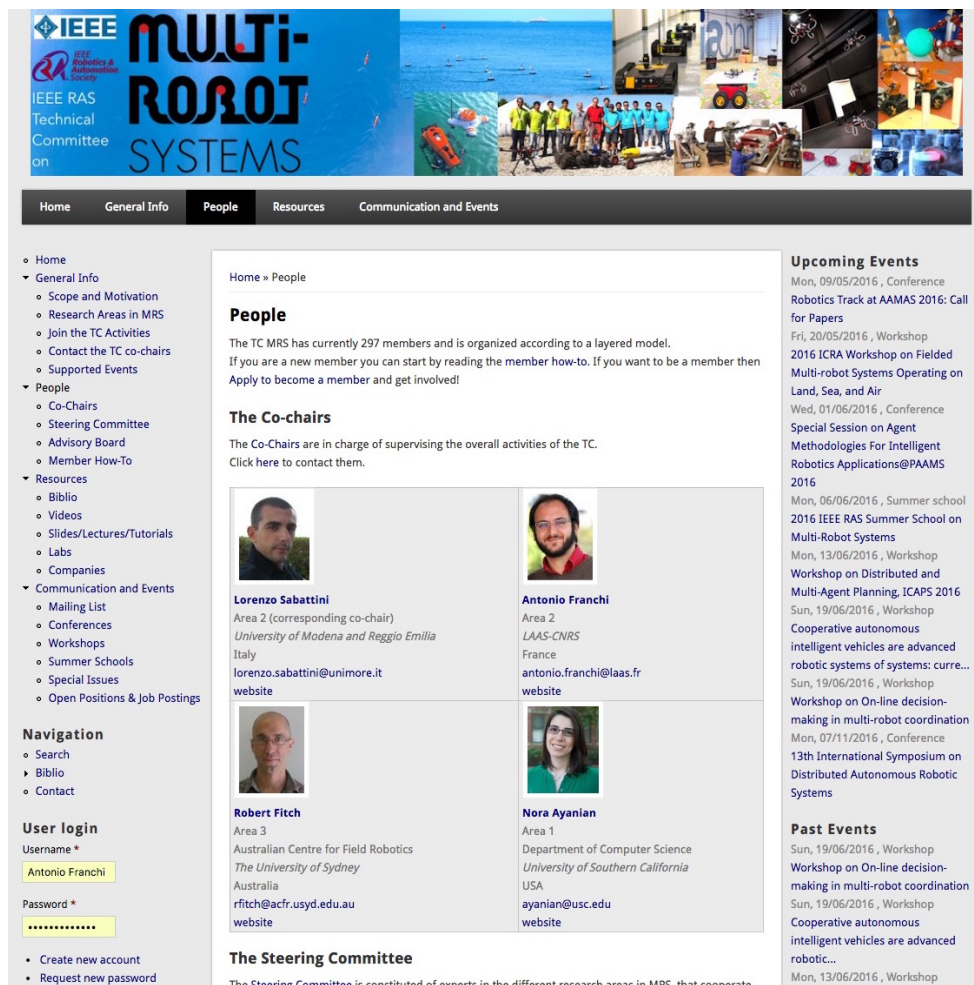

Figure 2.23: The website (of which I am the webmaster) of the co-founded and co-chaired IEEE RAS Technical committee on Multi-Robot Systems.

of LAAS, named 'Robotics and InteractionS' (RIS) which counts 8 permanent researchers, each one managing his own group with an average of 7-8 members per group, for a total of about 50 members. Managing the interaction of my group with the other members of the RIS team and the other researchers working in robotics at LAAS is also an crucial task of my current activity of researcher.

Participation in the community

During the last 30 months spent at LAAS-CNRS I co-organized 5 workshops in flagship robotics conferences: 1) the 2014 IEEE ICRA Workshop named "On the Centrality of Decentralization in Multi-robot Systems: Holy Grail or False Idol?", 2) the 2014 IEEE/RJS IROS Workshop on "The Future of Multiple-robot Research and its Multiple Identities", 3) the 2015 RSS Workshop on "Principle of Multi-Robot Systems", 4) the 2016 IEEE ICRA Workshop on "Fielded Multi-Robot Systems Operating on land, Sea, and Air", and the 5) the 2016 IEEE ICRA Workshop on "Aerial Robotics Manipulation: from Simulation to Real-life".

I then also organized the Invited Session: Rigidity Theory for Problems in Multi-Agent Coordination,

at 2015 54th CDC.

I kept on serving as Associate Editor of the IEEE Robotics and Automation Magazine and I also temporarily served in 2015 as Associate Editor, IEEE Aerospace and Electronic Systems Magazine.

I served as associate editor for the three 2014-, 2015-, and 2016 IEEE ICRA conferences and for the three 2014- 2015-, and 2016 IEEE/RSJ IROS conferences.

In Oct 2014 I co-founded of the Technical Committee on Multi-Robot Systems of IEEE RAS <http://multirobotsystems.org/> and have been serving as co-chair of the same committee since then. After only 1.5 years the Technical Committee is very active and successful, counting already almost 300 members, see Figure 2.23.

In 2016, I also co-proposed and co-organized the 2016 IEEE RAS Summer School on Multi-Robot Systems, that will be held at NUS, Singapore.

Since April 2016 I am an IEEE Senior Member.

Chapter 3

A Focused Chapter: Human-Collaborative Schemes in the Motion Control of Single and Multiple Mobile Robots

With this chapter I aim focusing the report on a particular topic that is transversal to my research activities, in the sense that it spans a broad set of works and several years of research. I treat this topic in an more comprehensive way compared to the short overview given in Chapter 2 and I also put my works in this topic in perspective with respect to the state of the art.

This chapter has served as a basis for a very recent book chapter ([Franchi 2016](#)) that I wrote as single author and that is part of the book “Trends in Control and Decision-Making for Human-Robot Collaboration Systems”. Ed. by Y. Wang and F. Zhang. Springer.

3.1 Abstract

In this chapter we show and compare several representative examples of human-collaborative schemes in the control of mobile robots, with a particular emphasis on the aerial robot case. We first provide a simplified yet descriptive model of the robot and its interactions. We then use this model to define a taxonomy that highlights the main aspects of these collaboration schemes, such as: the physical domain of the robots, the degree of autonomy, the force interaction with the operator (e.g., the unilateral versus the bilateral haptic shared control), the near-operation versus the teleoperation, the contact-free versus the physically interactive situation, the use of onboard sensors, and the presence of a time-horizon in the operator reference. We then specialize the proposed taxonomy to the multi-robot case in which we further distinguish the methods depending on their level of centralization, the presence of leader-follower schemes, of formation control schemes, the ability to preserve graph theoretical properties, and to perform cooperative physical interaction. The common denominator of all the examples presented in this chapter is the presence of a human operator in the control loop. The main goal of the chapter is to introduce the reader and provide a first-level analysis on the several ways to effectively include human operators in the control of both single and multiple aerial robots and, by extension, of more

generic mobile robots.

3.2 Introduction

A mobile robot is primarily a machine that is able to perceive the surrounding environment and move in it in a safe and effective way for the humans, for itself, and for the given objective. The ability to automatically control its own motion, at both the higher level (guidance, planning) and the lower one (navigation and servoing), constitutes one of the fundamental building blocks of the sought robot autonomy. However, robots, which in general do not exist and operate isolated from humans, can actually improve their effectiveness in achieving the given task by means of a well-designed human-collaborative control schemes. Analyzing and properly designing the way to achieve an optimal human collaboration is therefore a crucial aspect in order to attain a fully mature robotic system that is able to operate in a complex and real world.

In this chapter we show and compare several ways to effectively design the collaborative control. We do so by first introducing a simple yet descriptive model for the robots and the human interfaces. We then propose a list of what we consider fundamental axes for a proper classification of the collaborative scheme, namely the

- *physical domain of the robots* as, e.g., whether they are operating and moving on the ground or in the air;
- *degree of autonomy from the human operator*, i.e., at which level and with which frequency the human operator is involved in influencing the robot motion, in particular, in this chapter we mainly focus on the so called 'shared control' case. Within this case we further specialize our taxonomy depending on the *presence of a time-horizon in the reference* that is sent by the operator to the robots.
- *kind force interaction with the operator*, i.e., whether the collaboration involves or not mechanical interaction and haptics and in which direction (forward-force, feedback-force (bilateral), unilateral);
- *near-operation versus the teleoperation*;
- *amount of physical interaction with the environment*;
- *use of onboard sensors*;

The proposed taxonomy is then further specialized in the case of the use of multiple robots, for which we introduce an additional axes, namely the

- *level of centralization*;
- use of a scheme of the kind *master-leader-followers*;
- use of a scheme of the kind *formation-orthogonal*;
- use of a scheme of the kind *global property preservation*;

- *ability to perform cooperative physical maneuvers.*

The common denominator of all the axes presented in this chapter is the presence of a human operator in the control loop. In fact, fully autonomous control algorithms are not in general easy to extend in order to cope with (and to exploit) the presence of a human operator. The main goal of the chapter is therefore to introduce the reader to the several ways to effectively include human operators in the control of both single and multiple aerial mobile robots, and to provide a first-level analysis on these systems. A particular emphasis is set on the aerial robots case, which is at date not yet fully explored and understood, and is among the most challenging cases. Nevertheless, all the presented aerial robotics schemes are easily transferable to many other mobile robot as well.

3.3 Modeling of the Robot and the Interactions

In this section we provide a formal description of the robot and its interactions. The main goal is to introduce a standard model and a nomenclature that is convenient for the description of human-collaborative schemes like the ones that we illustrate in this chapter. For the sake of completeness, the notation introduced goes beyond the examples included in the taxonomy proposed in the next sections.

3.3.1 Mobile Robot

A *mobile robot* can be viewed as a mechanical system possessing some degrees of freedom (DoFs) that is equipped with actuators, sensors, a processing unit, a communication module, and a mathematical model of itself and the surrounding environment. The combination of all these components are used by the robot to control its own DoFs and, as a byproduct, to modify the state of the surrounding environment, in presence of external disturbances and uncertainties. We refer to Figure 3.1 for a high-level model of a mobile robot physically interacting and communicating with the surrounding environment.

The *configuration* of the $n_q \in \mathbb{N}$ DoFs of the robot is represented by a vector $\mathbf{q} \in \mathbb{R}^{n_q}$. The physical model of the robots is implicitly represented by a differential equation

$$\dot{\mathbf{x}} = \mathbf{f}_r(\mathbf{x}, \mathbf{u}, \mathbf{d}) \quad (3.1)$$

where $\mathbf{x} \in \mathbb{R}^{n_x}$ is the *physical state*, $\mathbf{u} \in \mathbb{R}^{n_u}$ is the *control input* (a signal that the processing unit can change arbitrarily and drives the robot actuators), and $\mathbf{d} \in \mathbb{R}^{n_d}$ is the *external input* (a signal that the is out of control to the robot and can represent both the interaction with the environment and the inaccuracies of the model). The vector \mathbf{x} includes the configuration \mathbf{q} and may include also its derivative, i.e., $\mathbf{x} = (\mathbf{q}^T \dot{\mathbf{q}}^T)^T$.

In presence of more than one robot we assume an index $i \in \{1, \dots, N\}$ being associated to each robot, where N is the total number of robots. We shall refer to the robot associated to i as the '*i*-th robot' or the 'robot *i*'. The quantities corresponding to the *i*-th robot are added the subscript *i*, e.g., \mathbf{x} becomes \mathbf{x}_i , \mathbf{u} becomes \mathbf{u}_i , and so on so forth.

The sensors of a robot typically provide a partial information about the physical state, the external input, and the surrounding environment. This information is in general represented by the measurement function

$$\mathbf{y} = \mathbf{h}(\mathbf{x}, \mathbf{u}, \mathbf{d}, \mathbf{x}_e) \quad (3.2)$$

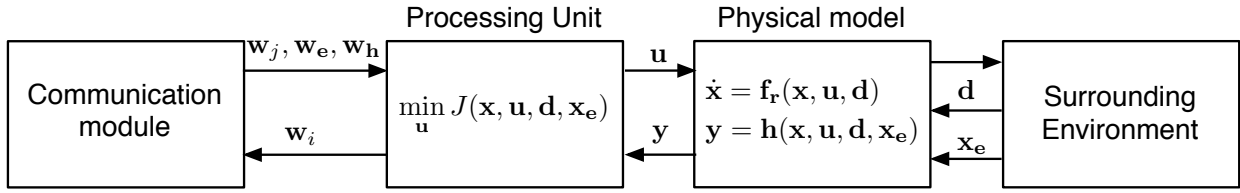

Figure 3.1: High-level model of the i -th mobile robot.

where $\mathbf{y} \in \mathbb{R}^{n_y}$ is the *measurement* and $\mathbf{x}_e \in \mathbb{R}^{n_{x_e}}$ is the *environment state*, which may include external objects, other robots as seen by the robot i , and a nearby human collaborator.

The *communication module* provides the robots additional signals that can be used by its processing unit to achieve their mission. A signal that comes from another robot j is denoted with $\mathbf{w}_j \in \mathbb{R}^{n_{w_j}}$, where $j \in \mathcal{N}_i$, being $\mathcal{N}_i \subseteq \{1, \dots, N\}$ the set of robots that communicate with the robot i (*communication neighbors*). A signal that comes from the human-robot interface is instead denoted with $\mathbf{w}_h \in \mathbb{R}^{n_{w_h}}$. A signal could come also from other sources (like, e.g., a smart environment) in that case we denote it with $\mathbf{w}_e \in \mathbb{R}^{n_{w_e}}$. The communication module is also in charge of disseminating to each robot j , with $j \in \mathcal{N}_i$, the signal \mathbf{w}_i coming from the robot processing unit.

The *processing unit* implements a robot control algorithm that chooses \mathbf{u} in order to, typically, minimize an objective function

$$J(\mathbf{x}, \mathbf{u}, \mathbf{d}, \mathbf{x}_e, \{\mathbf{w}_j | j \in \mathcal{N}_i\}, \mathbf{w}_h, \mathbf{w}_e). \quad (3.3)$$

In order to do so, the robot control algorithm can rely on the following information:

- a model of the robot (e.g., (3.1)) and a model of the environment
- the measurement \mathbf{y}
- the communicated signals $\{\mathbf{w}_j | j \in \mathcal{N}_i\}$, \mathbf{w}_h , and \mathbf{w}_e ,

which constitute the input to the control algorithm. The output of the control algorithm is \mathbf{u} , i.e., the control input to the actuators.

3.3.2 Communication Infrastructure

A network of robots is a group of robots whose processing units communicate through a communication infrastructure. The simplest way to model the overall communication state is to consider a graph $\mathcal{G} = \{\mathcal{I}, \mathcal{E}\}$, where the set of vertexes $\mathcal{I} = \{1, \dots, N\}$ represents the robots in the network, and $\mathcal{E} \subset \mathcal{I} \times \mathcal{I}$ is the set of edges for which $(i, j) \in \mathcal{E}$ if and only if $j \in \mathcal{N}_i$, where \mathcal{N}_i has been previously defined as the set of communication neighbors of the robot i .

A graph has an algebraic representation given by the adjacency and the incidence matrixes, denoted with \mathbf{A} and \mathbf{E} , respectively (see, e.g., (Robuffo Giordano et al. 2013; Zelazo et al. 2014) for the formal definitions of these and all the algebraic graph concepts mentioned in this chapter). Another matrix that plays an important role in the control of networks of robots is the Laplacian matrix $\mathbf{L} = \mathbf{E}^T \mathbf{E} \in \mathbb{R}^{N \times N}$, which is always positive semidefinite, i.e., with all real and non-negative eigenvalues. A fundamental result in algebraic graph theory is that the multiplicity of the eigenvalue $\lambda_1 = 0$ of \mathbf{L} is equal to number

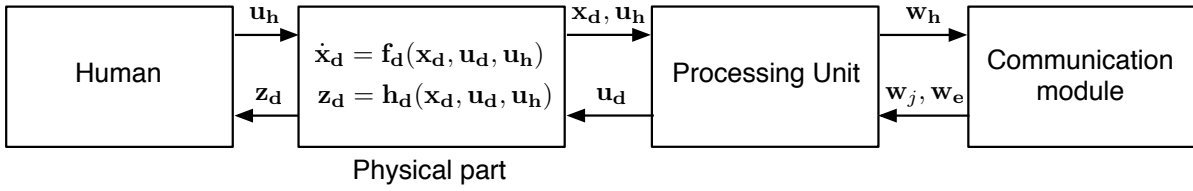

Figure 3.2: High-level model of the human-robot interface.

of connected components of \mathcal{G} (Fiedler 1973). For this reason, the second smallest eigenvalue of \mathbf{L} , typically denoted with λ_2 , is called algebraic connectivity, and $\lambda_2 > 0$ if and only if the graph is connected. Those definitions extend seamlessly to the case of weighted graphs, i.e., graphs in which a weight number is associated to each edge, representing, e.g., the quality of the communication. Algebraic graph theory plays a fundamental role in the control of networked robots, see, e.g., (Mesbahi and Egerstedt 2010) for an introduction to this vast topic.

3.3.3 Human-robot Interface

A *human-robot interface* is an input-output device that allows a human operator to retrieve/send information from/to one or more robots at the same time. The interface is constituted by a physical part, which is able to record the human actions and to provide a sensorial feedback to the human, a processing unit, and a communication module. Examples of interfaces are joysticks, control pads, button pads, displays, movement recognition units, and haptic interfaces, just to mention a few. We refer the reader to Figure 3.2 for a high-level model of a human-robot interface robot interacting with the human and communicating with the robots.

The *physical part* of the interface is implicitly modeled by a differential equation

$$\dot{\mathbf{x}}_d = \mathbf{f}_d(\mathbf{x}_d, \mathbf{u}_d, \mathbf{u}_h) \quad (3.4)$$

where $\mathbf{x}_d \in \mathbb{R}^{n_{x_d}}$, is the *state of the interface*, $\mathbf{u}_d \in \mathbb{R}^{n_{u_d}}$ is the *control input of the interface* (a signal that can be changed arbitrarily by the processing unit), and $\mathbf{u}_h \in \mathbb{R}^{n_{u_h}}$ is the *external input from the human operator* (a signal that is out of control of the interface and represents the human input to the system). We do not include inaccuracies and disturbances in the interface model since human-robot interfaces are typically well-calibrated instruments that operate in a structured environment. For the same reason we assume that the internal state of the interface \mathbf{x}_d is fully measurable.

The *communication module* feeds the interface with signals coming from a set of robots denoted with $\mathcal{N}_d \subseteq \{1, \dots, N\}$ and called *interface neighbors*. We denote the signal coming from the robot $l \in \mathcal{N}_d$ with $\mathbf{w}_{d_l} \in \mathbb{R}^{n_{w_{d_l}}}$. As in the previous case, additional signals coming from other sources (like, e.g., a smart environment) are denoted with $\mathbf{w}_e \in \mathbb{R}^{n_{w_e}}$. Finally, the communication module is also in charge of sending the signal \mathbf{w}_h to the robots in \mathcal{N}_d .

The *processing unit* of the interface has two roles. The first role is to compute \mathbf{w}_h on the basis of \mathbf{x}_d so that the human can influence the motion control of the robots. The second role is to provide a *feedback to the human operator* in the form of, e.g., an image, a change of color, a beep sound, a force provided back to the operator in a haptic interface, and so on. Generically speaking, any kind of

feedback can be modeled by a static function

$$\mathbf{z}_d = \mathbf{h}_d(\mathbf{x}_d, \mathbf{u}_d, \mathbf{u}_h). \quad (3.5)$$

The input \mathbf{u}_d is computed with the purpose of letting \mathbf{z}_d be informative of the communicated signals $\{\mathbf{w}_j | j \in \mathcal{N}_i\}$, \mathbf{w}_h , and \mathbf{w}_e .

3.4 A Taxonomy of Collaborative Human–robot Control

In this section we present a taxonomy¹ for the situation in which a human collaborates in the motion control of one or multiple mobile robots. We shall refer when needed to the terminology introduced in Section 3.3. A particular emphasis will be given to the case of aerial robots, even though many results and considerations hold for any kind of mobile robot.

3.4.1 Physical Domain of the Robots

First of all, the *collaborative human-robot control* can be divided in several categories, corresponding to the physical domain of the robotic system, i.e., terrestrial (ground), aerial, space, marine, and underwater, just to mention the main ones. In the following we provide a quick review on the models used for the first two domains.

The models of ground robots stop typically at the kinematic level. An example is to consider $\mathbf{x} = (\mathbf{p}^T \ \psi)^T \in \text{SE}(2)$ where \mathbf{p}^T and ψ are the position and orientation of the mobile robot, respectively. The simplest model can be represented as $\dot{\mathbf{x}} = \mathbf{u}$ if the robot is omnidirectional and holonomic or as $\dot{\mathbf{x}} = \mathbf{G}(\mathbf{x})\mathbf{u}$ with $\text{rank}(\mathbf{G}) < 3$ if the platform is underactuated and non-holonomic.

Aerial robots cannot be modeled just kinematically because the dynamic effects are non-negligible, due mainly to: 1) the larger speed of aerial robots when compared to ground robots, and 2) the impossibility to aerodynamically generate input forces that are as strong as the one generated using the motor-wheel actuators available in the ground robot case. Furthermore, in order to increase the energy efficiency, the mechanical simplicity and robustness, and the lightness of the platform, a low number of actuators are used, leading to underactuated robots. The most used aerial robots nowadays are multi-rotor platforms, such as, e.g., the quadrotor configuration (Franchi et al. 2012c). In this case the robot state is the one of a rigid body floating in space $\mathbf{x} = ((\mathbf{p}, \mathbf{R}), \mathbf{v}, \boldsymbol{\omega}) \in \text{SE}(3) \times \mathbb{R}^3 \times \mathbb{R}^3$, where \mathbf{p} , \mathbf{R} , \mathbf{v} , and $\boldsymbol{\omega}$ represent the position, attitude, velocity, and angular velocity of the robot, respectively. The dynamical model is then the following

$$\dot{\mathbf{p}} = \mathbf{v} \quad (3.6)$$

$$\dot{\mathbf{v}} = \mathbf{f}_1(\mathbf{x}) + \mathbf{G}_1(\mathbf{x})\mathbf{u} \quad (3.7)$$

$$\dot{\mathbf{R}} = \mathbf{R}\boldsymbol{\omega} \quad (3.8)$$

$$\dot{\boldsymbol{\omega}} = \mathbf{f}_2(\mathbf{x}) + \mathbf{G}_2(\mathbf{x})\mathbf{u}. \quad (3.9)$$

In most of the cases, e.g., for coplanar multirotors, the attitude dynamics (the last two equations) is fully actuated (i.e., $\text{rank}(\mathbf{G}_2) = 3$), while the position dynamics (the first two equations) is under-

¹A taxonomy that is comprehensive of all the possible cases and shows all the most important works in collaborative human-robot control is clearly out of the scope of this chapter, which does not claim to be a complete survey of this huge topic.

actuated (typically $\text{rank}(\mathbf{G}_1) = 1$). Furthermore there is a cascaded structure in which \mathbf{f}_1 , \mathbf{G}_1 , \mathbf{f}_2 , and \mathbf{G}_2 depend only on \mathbf{R} and ω .

The increased range applications enabled by the use of aerial robots with respect to the exclusive use of ground robots, together with the larger complexity of aerial robots platforms made the design of collaborative human-aerial-robot control a particularly interest research domain. In this chapter we will therefore focus especially on the aerial robot case. However the proposed taxonomy and the large majority of presented methods apply for all the other domains as well.

3.4.2 Degree of Autonomy from the Human Operator

The *collaborative human-robot control* can be then roughly divided in three categories, corresponding to the degree of autonomy of the robotic system. This kind of classification, recalled in Table 3.1, is similar to the one used in the teleoperation literature, see e.g., (Niemeyer, Preusche, and Hirzinger 2008).

The separation between the three categories cannot be sharp. Typically, real situations show intermediate aspects between the three categories. In this chapter we will present works that belong mainly to shared control category, with some supervisory control aspects as well.

Direct Control

Direct control refers to the case in which the robot motion is completely (i.e., in all its DoFs) decided by the human operator. The role of the robot is only to reproduce the human operator motion with as much fidelity as possible. In this case the human-robot interface has the same number of DoFs of the robot ($n_x = n_{x_d}$), $\mathbf{w}_h = \mathbf{x}_d$, and the goal of the robot control \mathbf{u} is to have

$$J = \|\mathbf{x} - \mathbf{w}_h\| < \varepsilon \quad (3.10)$$

with ε as small as possible.

Supervisory control

Supervisory control refers to the case in which the robot motion is mainly controlled by autonomous decisions of the robot, while the human operator is in charge of providing only high-level directives to be fulfilled. In this also case the human-robot interface has typically a much lower number of DoFs of the robot ($n_x > n_{x_d}$), and the goal of the robot control \mathbf{u} is to minimize

$$J = \|\mathbf{h}(\mathbf{x}(t^*), \mathbf{x}_e(t^*)) - \mathbf{w}_h\| \quad (3.11)$$

where in this case $\mathbf{h}(\mathbf{x}, \mathbf{x}_e(t^*))$ is a projection map for both the robot and environment state and t^* are some particular time instants in which the sub-task should be achieved.

Table 3.1: Degrees of autonomy in the human-robot collaborative control

<i>Non-robotic systems</i>	<i>Robotic systems</i>			
Fully human-operated	Collaborative human-robot control			Fully autonomous
	Direct	Shared	Supervisory	

Shared Control

Shared control refers to the case in which the robot motion is determined by both the human operator and robot decisions in a mostly balanced fashion. In this case typically the human-robot interface has a lower number of DoFs of the robot ($n_x > n_{x_d}$), and the goal of the robot control \mathbf{u} is to minimize

$$J = \|\mathbf{h}(\mathbf{x}) - \mathbf{w}_h\| \quad (3.12)$$

where $\mathbf{h}(\mathbf{x})$ is a map that projects \mathbf{x} on the lower-dimensional space controlled by the human operator.

Time Horizon in the Operator Reference Another important aspect in the collaborative control schemes that we are analyzing is the length of the time horizon associated to the reference signal (e.g., desired position or velocity) given by the operator to the robot. In the direct control case the length of time-horizon is intrinsically zero since the operator reference is instantaneous and refers to the ‘now’. On the contrary in supervisory control schemes the time-horizon is typically very large and the reference command pertains to some time instant in the relative long-term future, as explained before in this chapter.

In the shared control scenario the presence of intermediate cases is possible. However, in the literature, the majority of the shared control works considers that the human operator is in charge of guiding the aerial robot during the task by specifying the current reference position or velocity, as e.g., in (Schill, Hou, and Mahony 2010; Mersha, Stramigioli, and Carloni 2012; Stegagno et al. 2014). This persistent commitment can result rather demanding for the human operator. Furthermore instantaneous and persistent collaboration may be unnecessary in some parts of the task execution, such as in all the applications in which the robot has to follow a predefined path and the purpose of the operator is only to provide sporadic modification to the planned path in response to unpredicted changes of the external situation.

In the work presented in (Masone et al. 2014) (see Figure 3.3 for an illustration of this scheme) this consideration is taken into account and the collaboration is shifted directly at the planning level by letting the human operator control the planned path for a given future (and non-negligible) time horizon. First, the operator is in charge of modifying online the shape of a planned path with a haptic interface (e.g., by changing the location of some control points). Secondly the robot autonomously correct the modified path in order to meet additional requirements such as collision avoidance, dynamic limits etc. Finally, consistently with the spirit of feedback-force schemes, the haptic cue is computed based on the mismatch between the path modification requests asked by the operator and the autonomous modifications of the robot using an impedance-like algorithm. In our formalism, this kind of paradigm can be summarized by the following equations:

$$J = \|\mathbf{h}(\mathbf{x}_{[t,t+T]}) - \mathbf{x}_d\| \quad (3.13)$$

$$\mathbf{u}_d = \mathbf{K}(\mathbf{h}(\bar{\mathbf{x}}_{[t,t+T]}) - \mathbf{x}_d) + \mathbf{f}(\mathbf{x}_d), \quad (3.14)$$

where $\mathbf{x}_{[t,t+T]}$ represents the future state of the robot in the time horizon $T > 0$, and $\bar{\mathbf{x}}_{[t,t+T]}$ is state re-planned by the robot.

A interesting future direction in this sense would be to study task-dependent automatic adaptation of the length of the time-horizon in the operator reference.

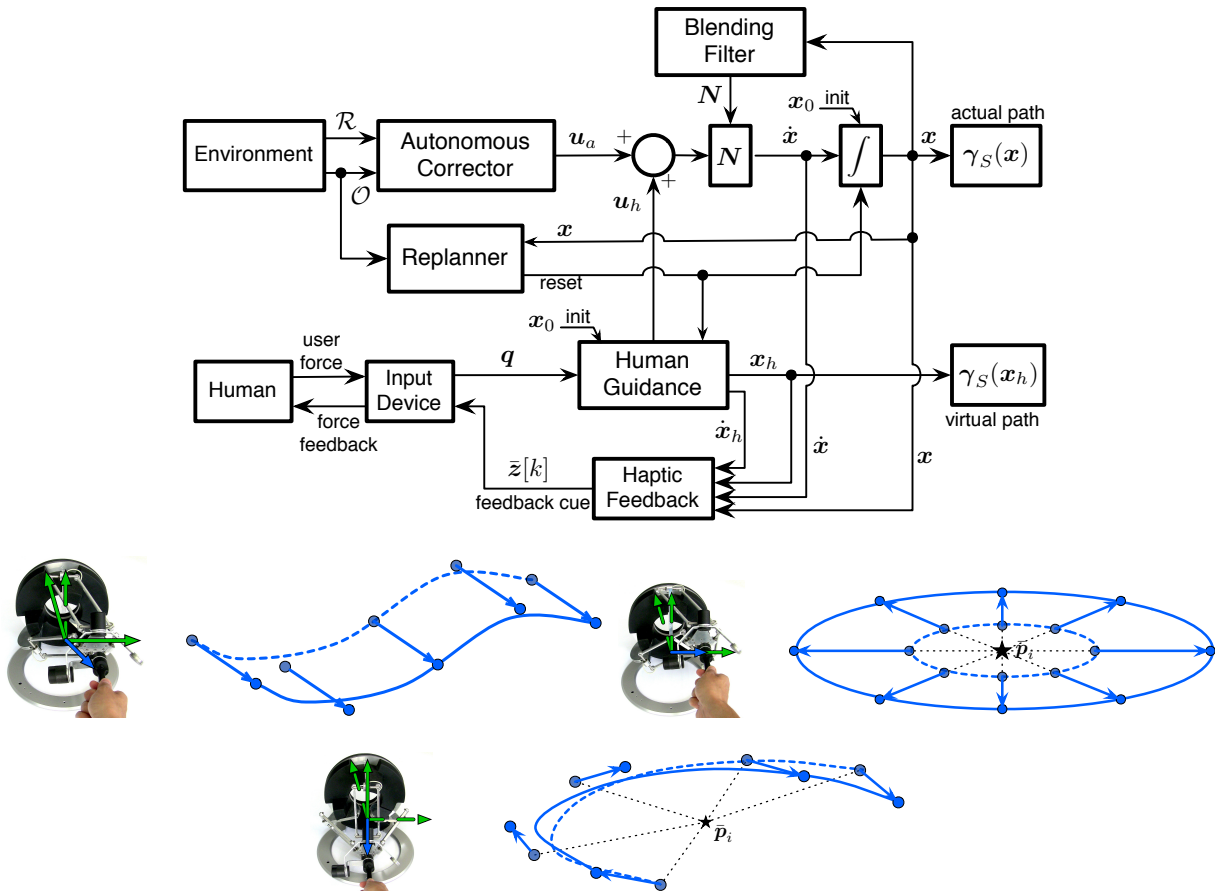

Figure 3.3: Top: block diagram of a feedback-force human-robot collaboration scheme with relatively long time horizon in the operator reference. Bottom: Examples of canonical path transformations. Green arrows represent the DoFs. Depending on the transformation the device motion is artificially restricted (continuous green arrows): 2 DoFs for translation, 1 DoFs for scaling, 1 DoFs for rotation. Blue arrows represent the commands and corresponding motion of the control points.

Outside the two extremes of collaborative control there are two cases which do not involve collaboration, see Table 3.1.

A robot is *fully autonomous* if the human operator has no influence on it, i.e., the signal \mathbf{w}_h is empty.

The antipodal case is when the human is in charge of steering all the DoFs by means of low-level actions, like while driving a (non-autonomous) car or operating a mechanical tool. In this case the machine is not a robotic system, because it lacks of any relevant autonomous aspect. The machine is said *fully human-operated*. In this case the human acts directly on \mathbf{u} .

Non-Collaborative Human-robot Control

Outside the two extremes of collaborative control there are two cases which do not involve collaboration, see Table 3.1.

A robot is *fully autonomous* if the human operator has no influence on it, i.e., the signal \mathbf{w}_h is empty.

The antipodal case is when the human is in charge of steering all the DoFs by means of low-level actions, like while driving a (non-autonomous) car or operating a mechanical tool. In this case the machine is not a robotic system, because it lacks of any relevant autonomous aspect. The machine is said *fully human-operated*. In this case the human acts directly on \mathbf{u} .

3.4.3 Force Interaction with the Operator

Another distinction can be made depending on the information value given to the *mechanical exchange* between the human operator and the interface.

A collaboration scheme is *forward-force* if the force exerted by the human operator is informative for the collaborative control. In other words, in a forward-force collaboration, the human input \mathbf{u}_h includes a measure (or an indirect estimation) of the force exerted by the human operator on the human-robot interface and this measure influences \mathbf{w}_h as well.

A collaboration scheme is *feedback-force* (or *bilateral*) if the human-robot interface exerts, towards the human operator, a force that conveys some information related to the collaborative control. In other words, in a feedback-force collaboration the feedback to the human operator \mathbf{z}_d includes a force exerted by the interface toward the human operator. An interface that is not feedback-force (bilateral) is said *unilateral*.

Notice that:

- in this terminology, ‘unilateral’ means that there is no force feedback. Other kind of feedback signals (e.g., visual) may be still present in a unilateral scheme;
- a feedback-force scheme does not necessarily imply that the scheme is also forward-force and, vice versa, a forward-force scheme could be unilateral;
- the previous definitions can be extended by replacing force with mechanical quantities related to forces and, more in general, mechanical power such as, e.g., moments, stiffness/compliance, and friction.

Forward-force schemes include the so-called ‘force–position’ or admittance-based schemes, in which the force provided by the human operator \mathbf{u}_h is recorded by a force sensor or estimated by an observer on the human interface and it is used to generate online a reference position and velocity that the robot tracks using a local position control loop. In our formalism this kind of scheme can be represented by

$$\dot{\mathbf{x}}_{\text{ref}} = \mathbf{f}(\mathbf{x}_{\text{ref}}, \mathbf{u}_h) \quad (3.15)$$

$$J = \|\mathbf{h}(\mathbf{x}) - \mathbf{x}_{\text{ref}}\|. \quad (3.16)$$

This kind of approach has been used e.g., in (Schill, Hou, and Mahony 2010) where the authors propose an admittance control modality for controlling an aerial vehicle. The operator applies a force to a haptic interface and the interface responds with a corresponding displacement, at the same time the force applied by the operator is used to generate a reference for the vehicle controller.

The simplest feedback-force schemes are the so-called ‘position-force’ or impedance-based schemes. In these schemes the configuration in which a haptic device is set by the operator is used a reference position or velocity for the robot. The force feedback is then proportional to the mismatch between the actual position/velocity and the reference. In our formalism this kind of scheme can be represented by

$$J = \|\mathbf{h}(\mathbf{x}) - \mathbf{x}_d\| \quad (3.17)$$

$$\mathbf{u}_d = \mathbf{K}(\mathbf{h}(\mathbf{x}) - \mathbf{x}_d) + \mathbf{f}(\mathbf{x}_d), \quad (3.18)$$

where \mathbf{K} and $\mathbf{f}(\mathbf{x}_d)$ are a gain matrix and a stabilizing term for the device, respectively.

A seminal work in this field is (Diolaiti and Melchiorri 2002), where a force feedback scheme based on virtual viscoelastic couplings is designed for controlling a ground mobile robot in an obstacle populated environment. Extension to the multiple ground-robot case has been considered, e.g., in (Lee, Martinez-Palafox, and Spong 2005). Finally many applications and extensions of this concept to the aerial robot case can be found in the very recent literature, see, e.g., (Stramigioli, Mahony, and Corke 2010; Rodríguez-Seda et al. 2010; Franchi et al. 2011; Lee et al. 2011; Mersha, Stramigioli, and Carloni 2012).

More advanced feedback force schemes include in the feedback the measurement of the force exerted by the robot on the environment or vice versa. In (Hou and Mahony 2013) the authors propose a scheme that is both forward-force and feedback-force to control an aerial robot. The forward scheme is similar to an admittance-like one, while the feedback force is used to display obstacles using the concept of dynamic kinesthetic boundary. In (Farkhatdinov and Ryu 2010) a variable force-feedback gain is instead proposed.

Researcher efforts have also been directed toward the critical comparison between different schemes. In (Hou, Mahony, and Schill 2016) a theoretical and experimental comparison between the admittance- and impedance-like schemes is proposed both from the perceptual and performance point of view. In (Son et al. 2013) the authors compare two different haptic cueing, namely the aforementioned reference mismatch versus the obstacle force cueing.

The main advantage of forward-force schemes is the availability of an additional intuitive information channel for the human operator in the forward channel. The main disadvantage of forward-force is the necessity to measure the human force, which is usually very noisy and also difficult to give a unique interpretation among the different human operators.

The main advantages of feedback-force schemes are:

- the additional channel for providing information to the operator, which hopefully results in a more immersive experience;
- the fact that haptic feedback may result more immediate to interpret than visual feedback due to the longer cognitive pipeline related to the latter;
- the fact that haptic feedback requires less bandwidth than vision (e.g., to feedback the distance from an obstacle), which in turns generates less delay than vision in long-distance internet based communication, see, e.g., (Riedel et al. 2012).

The main disadvantages of feedback-force are:

- the fact that the force applied to the interface influences back its the motion in a way that might result involuntarily for the operator;
- the increased difficult to ensure overall stability;
- the sensibility to delays;
- the need to take into account ergonomics issues, which may increase operator fatigue.

Stability issues in the bilateral human-collaborative control of mobile robots have been addressed in several ways, many of which related to passivity based control such as, e.g., the passivity observer/passivity controller (PO/PC) approach (Hannaford and Ryu 2002) the passive-set-position-modulation (PSPM) approach (Lee and Huang 2010), and the two-layer approach (Franken et al. 2011).

3.4.4 Near-operation vs. Teleoperation

A human-robot collaborative control is a *near-operation* if the human operator perceives the scene related to the control task by direct sensing, e.g., by line-of-sight, sense of touch, etc. Conversely, the human-robot collaborative control is a *teleoperation* when the perception is made through indirect sensing, e.g., tele-vision, haptic interfaces, etc.

A teleoperation is *delayed* when the delays of the communication are non-negligible (due to, e.g., long distances or long processing times). As it is well known, the presence of delays in the teleoperation may have a dramatic influence on the stability of feedback-force schemes if not properly addressed, see, e.g., (Niemeyer, Preusche, and Hirzinger 2008) and reference therein.

Large delays (usually greater than 0.15 s) between the operator and the robots are unavoidable in intercontinental collaborative control settings. In addition to stability, those delays generate also practical problems in the quality of video streaming, the safety and the ability to maneuver the robot. In fact, in long-distances communication, the video transmission has usually a larger delay than the reception of state of the remote robots because of the larger size of the packets of the video streaming.

Examples of intercontinental shared control of aerial robots are still very few at date. In (Riedel et al. 2012) the authors show experiments of collaborative control for aerial robots with German–Korean intercontinental communication using a standard internet channel with average delay of 0.35 s (see Figure 3.4). In this work it is shown that the feedback-force scheme can be made stable in presence of such large delay and packet losses by resorting to the PSPM passivity based technique (Lee and Huang 2010). The benefit of using force feedback to detect obstacles in advance with respect to the more delayed visual feedback is also made clear through the experiments. Following the results provided in (Riedel et al. 2012), other intercontinental schemes for human-collaborative control with aerial vehicles have been studied and experimentally validated, such as e.g., in (Mersha et al. 2013).

A different, but still passivity based, technique is used in (Secchi et al. 2012) to cope with delays in the collaborative force interaction control of aerial robots. In this case the control scheme resorts to the two-layer architecture, in which a passivity layer (whose goal is to preserve passivity, hence stability, of the interconnection) is built on top of the transparency layer, whose goal is instead to deteriorate the quality of the references and the force feedback as less as possible (Franken et al. 2011).

3.4.5 Physical Interaction with the Environment

Another important distinction concerns the nature of physical interaction of the robot(s) with the environment. This represents a sort of dual aspect with respect to the force interaction on the human-operator side. Table 3.2 summarizes the tree cases described in the following.

When the robot interacts with a solid/impenetrable environment which can significantly constrain the robot DoFs then the physical interaction is *with contact*.

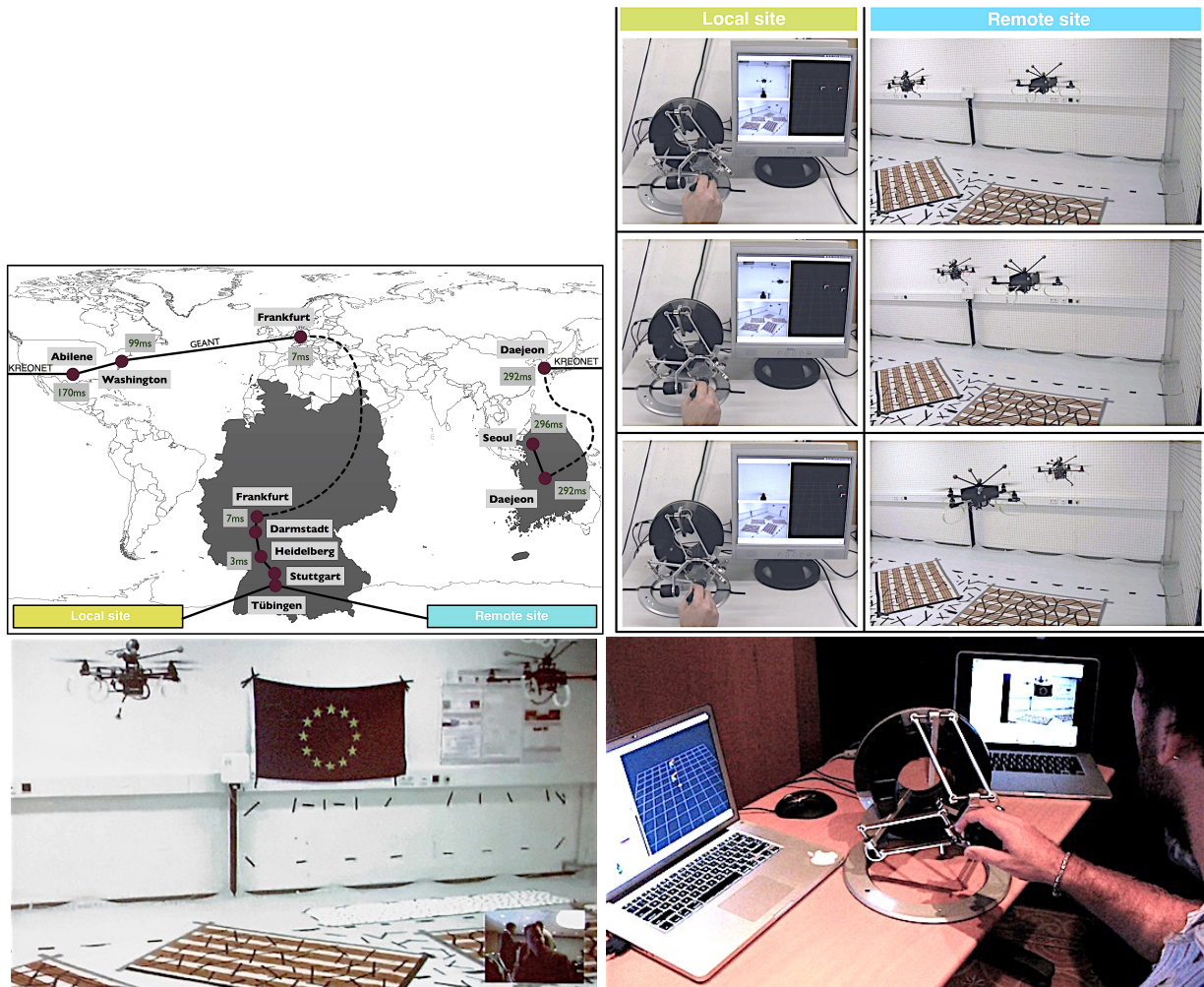

Figure 3.4: Experiments of intercontinental (Korean-German) feedback-force collaborative human-robot control. Top; scenario presented in (Riedel et al. 2012). Bottom: demo at the IEEE International Conference on Systems Man and Cybernetics 2012, in Seoul, South Korea.

The *contact-free physical interaction* case is instead when the robot is subject to external physical disturbances that are not constraining its DoFs, as in the previous case, but are mostly acting as an external disturbance, such as e.g., in the presence of wind, magnetic field, etc.

We finally refer to the *negligible physical interaction* case when physical interaction is only part of the actuation mechanism and plays almost no role in constraining or disturbing the robot motion. This is the case, e.g., of a ground mobile robot moving freely on a flat surface with perfect wheel traction, and of a multi-rotor robot flying in absence of wind and away from other surfaces (walls, floors, ceilings, etc.) thus not experiencing any undesired aerodynamical effect. Note that a sort of ‘physical interaction’ is actually present in both the examples and essential for the functioning of the robot (i.e., the wheel traction needed to produce the moving force, and the aerodynamic flow needed to produce the drag and the thrust forces). Nevertheless, these interactions do not constitute an impediment to the robot motion or an external disturbance that has to be compensated by the controller.

The cases of both fixed-base manipulators and grounded mobile manipulators have been deeply

studied in the past, see e.g., (Niemeyer, Preusche, and Hirzinger 2008; Lee and Spong 2005; Lee, Martinez-Palafox, and Spong 2005) and references therein for an overview of the state of the art.

A mostly open problem is instead the case of collaborative control of aerial robots in contact with the environment. In fact, while the study of control strategies for aerial robots in physical interaction with contact has received a lot of attention in the recent years, a few works exist at date addressing the more challenging problem of having a human in the loop with, e.g., a feedback-force scheme. An example of these few works is (Gioioso et al. 2015) where a teleoperation scheme is presented that allows to convert a contact-free physical interaction controller into a controller for physical interaction with contact, see Figure 3.5. The approach is based on the aerial physical interaction control algorithm presented in (Gioioso et al. 2014b), where using a rigid tool attached to the aerial vehicle the robot is able to exert a 3D force on the environment. Following the feedback-force paradigm, the algorithm in (Gioioso et al. 2015) provides the user with a force feedback that is proportional to the force measured by a force sensor at the tool-tip,

$$\mathbf{z}_d = \mathbf{d}. \quad (3.19)$$

During the contact-free approaching phases the algorithm automatically slows down the speed of the robot in order to achieve a smooth passage from free flight to contact constrained motion as shown in the block diagram of Figure 3.6. This kind of variable/tunable autonomy scheme is a typical example of collaborative shared control with physical interaction extended to the more challenging aerial robotics case.

3.4.6 Use of Onboard Sensors Only

Of fundamental importance in robotics is the ability of the robot to be fully autonomous from the sensing point of view. With respect to this issue we can roughly distinguish between two different classes of approaches: the approaches that use external sensorial infrastructures and the approaches that make use of onboard only sensorial equipment. The large majority of works in collaborative control of aerial robots belong to the first category. Motion capture systems, global positioning systems (GPS), and wireless based localization are some example of the infrastructures used in these works (Rodríguez-Seda et al. 2010; Franchi et al. 2012a; Lee et al. 2013; Mersha, Stramigioli, and Carloni 2012; Grabe et al. 2013).

Some recent efforts have been directed toward the second kind of approach, which presents clearly more challenges, especially in the aerial robotics case. The work in (Omari et al. 2013), where a bilateral teleoperation scheme for aerial robots is presented, represents a first step in the direction of the second class of approaches. In this work the state of the robot is retrieved using a motion capture system,

Table 3.2: Amount of physical interaction of the robot(s) with the environment

Amount of physical interaction of the robot with the environment		
With contact	Contact-free	Negligible
The external environment constrains the DoFs of the robot	The forces produced by the external environment do not constrain the DoFs of the robot	The disturbing/constraining external forces are negligible

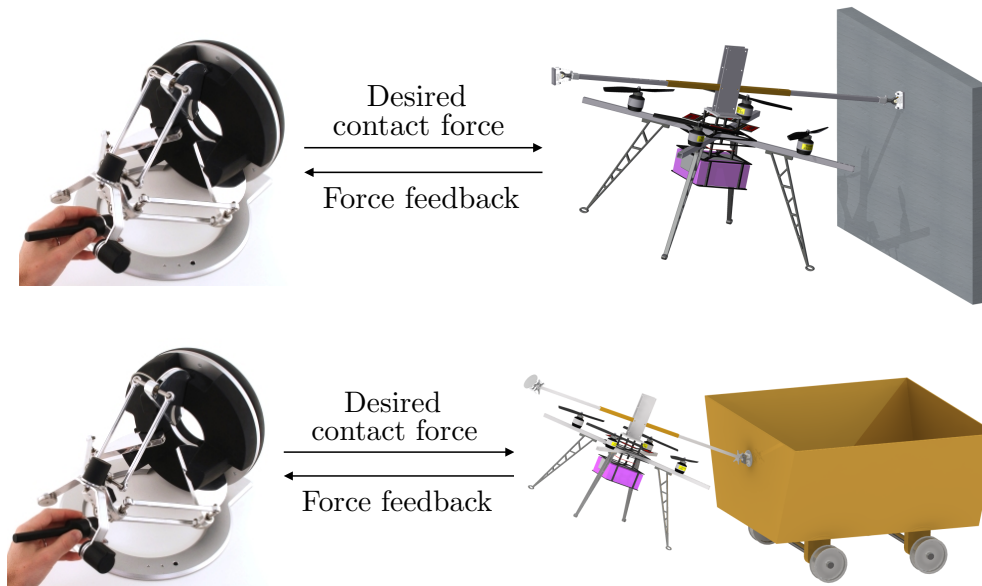

Figure 3.5: The scenarios of aerial teleoperation for physical interaction with contact considered in (Gioioso et al. 2015). Top: docking to a surface. Bottom: pushing a cart.

however the obstacle detection is performed using a laser range finder which then feeds the obstacle avoidance algorithm with onboard data.

In the experiments presented in (Franchi et al. 2012b) a human operator controls a group of aerial robots that use onboard cameras to measure the relative angles between themselves while the velocity is still estimated using an external motion capture system.

One of the first work addressing the problem of full-onboard sensorial equipment in the collaborative feedback-force control of aerial robots is presented in (Stegagno et al. 2014). The human operates with velocity control (and with the feedback-force paradigm) the aerial robot in an unstructured environment, see Figure 3.7. The state of the robot is estimated using only the onboard IMU and a depth camera (RGB-D). Thanks to the availability of the depth information the obstacle safety is ensured. During the collaboration the aerial robot conducts autonomously some extra-tasks that increase the ergonomics of the operation and its safety. The main of these tasks is a continuous pan scanning that temporarily enlarges the field of view of the robot exploiting the yaw DoF that is left free by the human operator collaboration. This movement is compensated in real time using an adaptive filter thus allowing the operator to experience a yaw-rate-free operation. The haptic feedback is based on the impedance paradigm where the actual velocity is estimated using a photometric error approach.

The development of human-collaborative control schemes that can cope with the use of onboard sensors only is crucial for the employment in the real world. However this aspect has been often overlooked by the recent literature, while it should probably deserve a higher attention.

3.5 A Taxonomy of Collaborative Human–Multi-robot Control

The collaborative scheme may include just one robot (*single-robot* case) or several distinct robots (*multi-robot* case). The use a group of coordinating and cooperating robots represents an enabling

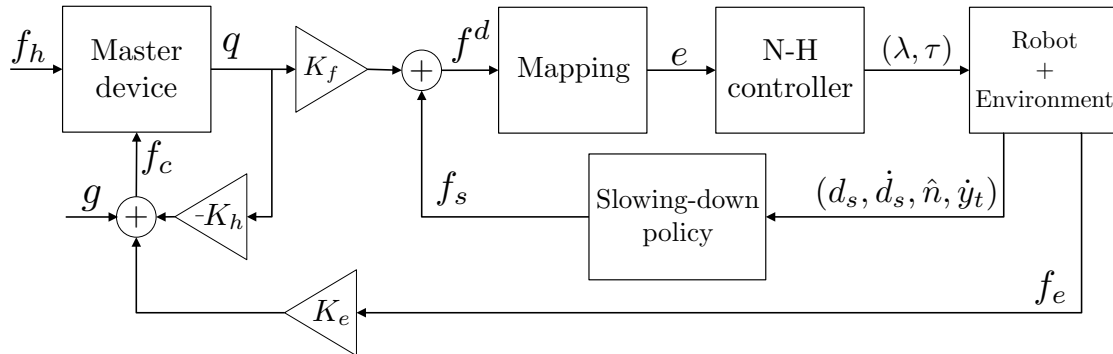

Figure 3.6: Block diagram of a control algorithm for aerial teleoperation in physical interaction with contact (Gioioso et al. 2015).

technology for a large number of applications. As a matter of fact multi-robot systems can show an improved robustness with respect to single point system failures and the capacity of adaptation to environments that are both uncertain and dynamic. Multi-robot systems may present also economical advantages compared to monolithic complex robots due to the lower price of small size systems. Range of applications span from data retrieval and collection, distributed sensing on large-scale areas, deep space interferometry, and search and rescue missions. Among multi-robot systems aerial robots play an essential role for their ability to cover large distances due to their speed and large areas thanks to the presence of the third (altitude) dimension.

Thanks to the appealing features and the great potentials of multiple aerial robot systems, the recent years have seen a sharp increasing in the study of collaborative human-robot schemes for such kind of robotic systems. The goal of this section is to revise and classify some of these approaches from a multi-robot perspective. In (Franchi et al. 2012c) the authors provide an overview that summarizes generic collaborative scheme for the bilateral shared control of groups of aerial robots. The proposed approach is able to integrate three main components, i.e., the human operator assistance, the force feedback and the control of the group topological and metrical properties. Regarding the last component the work suggests to consider three main cases, the unconstrained-, the connected-, and the constant-topology cases. In this section we aim at generalizing this classification taking into account additional aspects related to the collaborative human/multi-robot interaction.

3.5.1 Level of Centralization

A first classification when dealing with human collaborative schemes for multi-robot systems is about the level of centralization. Several definitions of decentralization has been given in the literature, which often overlap with the concept of a distributed algorithm. Here we adopt a simple definition that is the following: a scheme is decentralized (or distributed) if the amount of communication (packets exchanged) and computation (complexity) for unit of time, and the size of memory needed by each robot and by the human-robot interface, are constant when the total number of robots is increased. A scheme that is not decentralized is centralized. Centralized schemes are the one that need for example the communication graph \mathcal{G} to be complete, i.e., $(i, j) \in \mathcal{E} \forall i \neq j$. Centralized schemes are also the one assuming that the human-robot interface sends the message \mathbf{w}_h to all the robots in the team, i.e., $\mathcal{N}_i = N$.

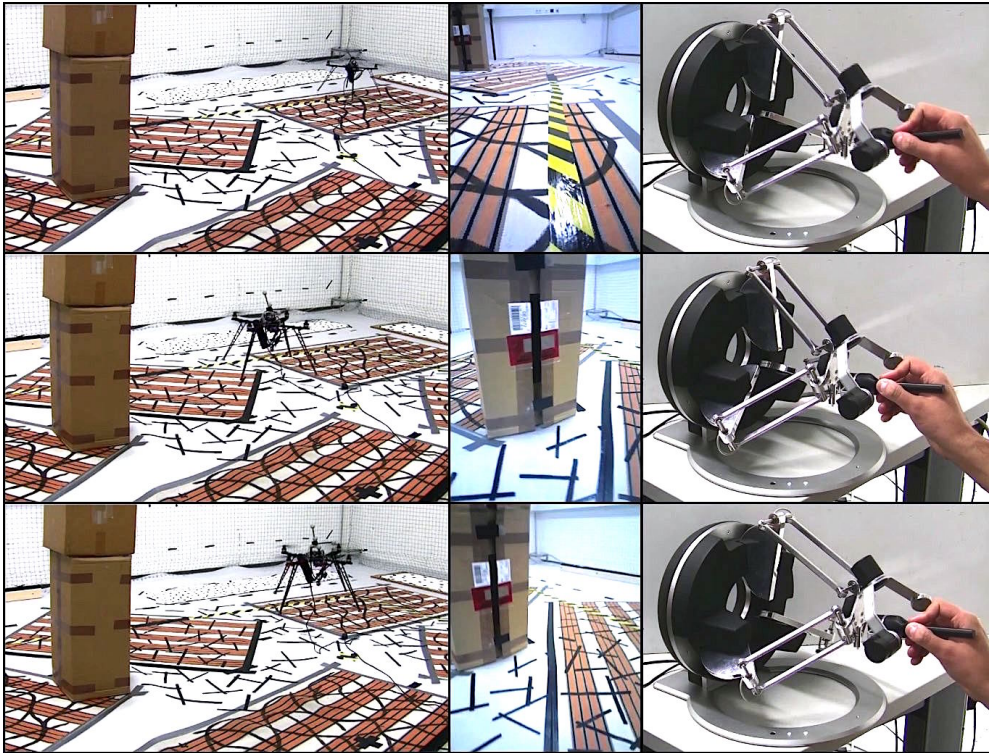

Figure 3.7: Experimental validation of a feedback-force collaboration scheme that uses onboard only sensors, namely an RGB-D camera and an IMU (Stegagno et al. 2014).

In general, decentralized algorithms are more scalable, i.e., applicable to higher number of robots, but are less efficient than centralized algorithm in the case of a smaller number of robot and when the communication bandwidth and the computation capabilities of each robot allow centralized implementations.

3.5.2 Master-leader-followers Schemes

A possible approach to collaboratively control a group of robots is the *master-leader-followers scheme*. In this scheme all the robots implement any decentralized control strategy resorting to local communication in order to carry on some task while the human operator (the master) communicates with only one robot of the group at time (the leader). All the non-leader robots are called the followers. For example the robotic team task could be to monitor a given area while keeping a certain formation, and the master, that is supervising the overall task providing, e.g., velocity references, can be in communication only with one robot at time due to long distance bandwidth limitations. This scenario is abstractly depicted in Figure 3.8(left).

Several challenging problems can arise even from this fairly basic situation when collaborative human-robot control is needed. A first example is the difficulty of maintaining the stability of the feedback-force interconnection between the human operator and such multi-robot system, especially in the case in which the multi-robot team interaction topology can arbitrarily switch even independently of the robot state. In fact, in (Franchi et al. 2012a) it is shown that this kind of switching interaction can generate a non-passive and potentially unstable behaviors. The authors then present a passivity-based

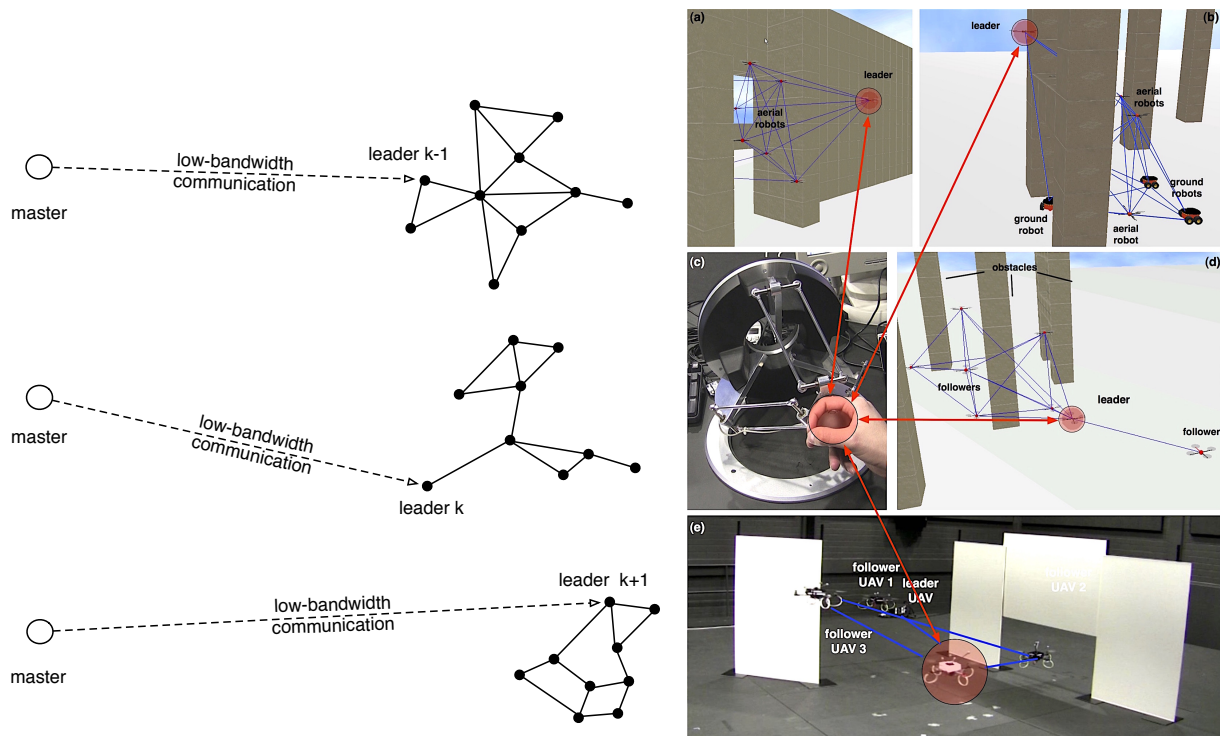

Figure 3.8: Left: abstraction of master-leader-followers scheme. The human operator (master agent) can communicate only with one robot at the time (the leader) using a low channel bandwidth. The leader robot and the followers communicated through a time-varying distributed communication topology.

Right: a human operator collaborates with a group of robots using as feedback-force scheme. Passivity of the heterogeneous team of robots is guaranteed despite the switching nature of the communication (Franchi et al. 2012a).

approach to guarantee a stable behavior of the leader and the followers regardless of the autonomous motion, the switching topology and the interaction with the environment. At the same time, making the multi-robot system passive turns instrumental for the feedback-force collaborative scheme with the human operator (the master). Experiments using this approach are show in Figure 3.8(right).

Another challenge arising in this context is called the *online leader selection* problem, i.e., the ability of the system to choose online the best leader that the master has to communicate with. This problem is addressed, e.g., in (Franchi, Bülthoff, and Robuffo Giordano 2011; Franchi and Robuffo Giordano 2016) for what concerns the maximization of the effectiveness of the velocity reference provided by the human operator. In this work the authors show that this effectiveness is upper-bounded by an index that depends on the current state of the robots and by a graph theoretical index, namely the algebraic connectivity of a special leader-dependent digraph.

3.5.3 Formation-orthogonal Control Schemes

Another approach to collaboratively control a group of robots is the *formation-orthogonal control* scheme. In this scheme the robots autonomously stabilize the relative geometry of the formation using relative or absolute measurements, while the human operator sends references to steer the remaining DoFs of the multi-robot system.

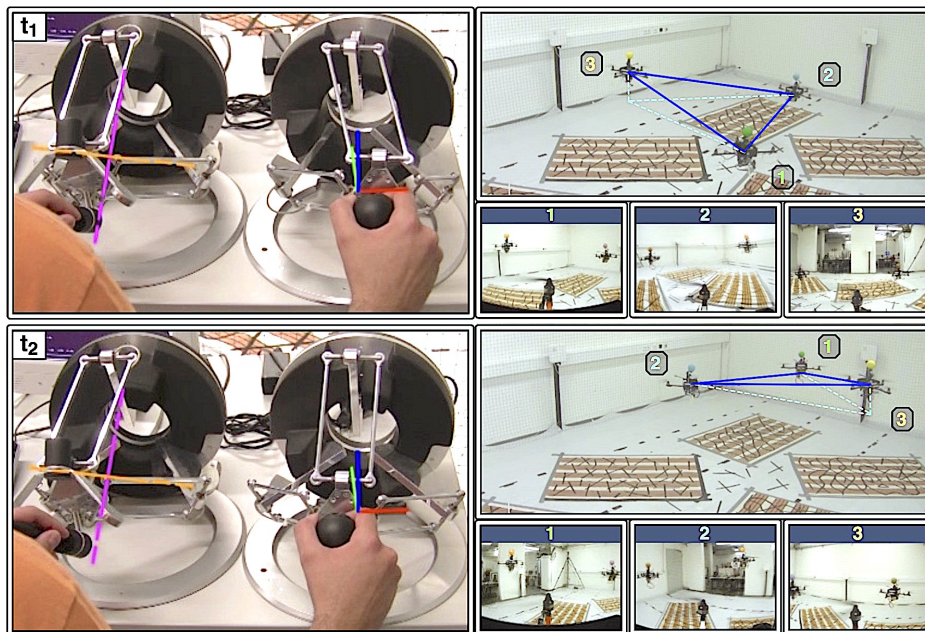
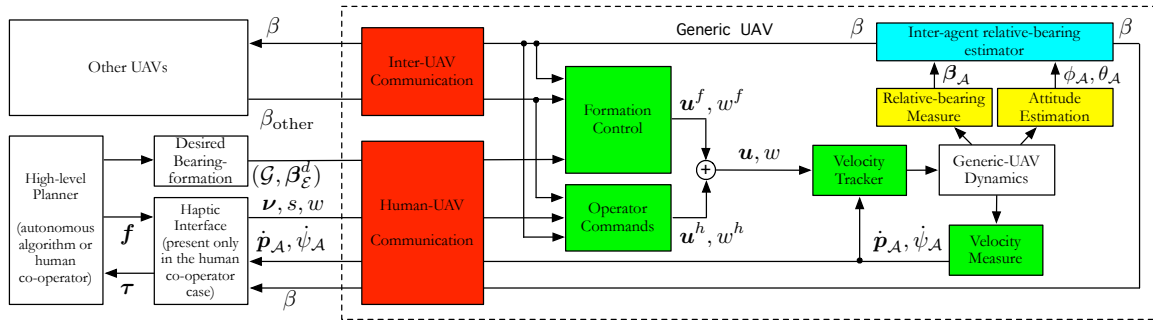

Figure 3.9: Top: block diagram of a formation-orthogonal collaboration scheme that uses relative bearing (angle) measurements (Franchi et al. 2012b).

Bottom: implementation with aerial robots using onboard cameras to retrieve the bearing measurements.

In (Lee and Spong 2005; Lee, Martinez-Palafox, and Spong 2005) the authors propose a method to bilaterally teleoperate a group robots such as, e.g., a group of ground mobile manipulators grasping an object. The main idea of the method relies on the concept of passive decomposition, with which it is possible to decompose the multi-robot dynamics in two independent systems while preserving passivity from an energetic point of view. The locked system abstracts the overall team motion and is controlled by the human operator using a feedback-force paradigm. The shape system defines instead the cooperative grasping aspect and is autonomously controlled by the team of robots. This paradigm allows the human to indirectly control the motion of the grasped object without influencing the reliability of the grasping.

Regarding the aerial robot case, in (Lee et al. 2013) the authors propose a feedback-force collaboration scheme in which the human operator teleoperates the motion of the multiple aerial robots that act as a virtual deformable object. The scheme is based on three layers: the low-level robot control, the online velocity reference generator, and the bilateral teleoperation layer. The low-level robot control

is used in order to abstract from the particular kind of dynamics of the robot. The velocity reference generator mixes together the velocity reference provided by the operator, the obstacle avoidance action, and the distance preservation term. The last two terms are based on an artificial potential approach. The haptic cue provided to the operator is proportional to the average of the velocity reference mismatch in a way that is similar to an impedance-like approach, but extended to the whole multi-robot system considered as a virtual large deformable object. In order to implement this formation control scheme the position measurements of each robot (e.g., from GPS) are needed.

An alternative (especially from the sensing point of view) formation-orthogonal control scheme is presented (Franchi et al. 2012b), see Figure 3.9. This case differs from (Lee et al. 2013) for three main aspects. The first is that it uses only measurements of the relative angles between the robots (that can be, e.g., retrieved from onboard cameras). The second is that the formation control approach used is almost globally convergent and it is not prone to local minima like the artificial potential schemes typically are. The third is that the human operator velocity reference acts on the tangent bundle of the manifold of configurations that keep the relative angles constant, which includes collective rotations, translations, and dilations. In this way the formation control specifications and the human control result always orthogonal and do not interfere with each others thus establishing a clear separation between the fully autonomous and the human-operated domains of intervention.

3.5.4 Group-property Preservation Schemes

Formation-orthogonal control schemes may excessively limit the relative mobility between the robots in the group by, e.g., blocking the relative distances and angles to some fixed or overly constrained values. On the other side, for some tasks it is enough to preserve some high-level structural properties of the group rather than determining the exact shape of it. We refer to such approaches as *group-property preservation schemes*.

A first example of high-level structural property of a group of robots is the connectivity of its topology, intended either as the communication network or the sensing graph. Connectivity is a very important property since it ensures that the data flow between the different robots cannot be broken and therefore the information can be successfully distributed.

In (Robuffo Giordano et al. 2013) the authors present a decentralized method that maintains group the connectivity in a flexible way, i.e., allowing the topology to change over time as long as connectivity is preserved, see Figure 3.10. Connectivity preservation is ensured by keeping the algebraic connectivity λ_2 (see Section 3.3.2) positive during all the robot maneuvers. The algebraic connectivity concept is then extended to take into account complex robot-to-robot interaction going beyond simple max-distance models, which brings to the definition of the generalized connectivity eigenvalue. This is obtained by introducing a state-dependent adjacency matrix $\mathbf{A}(\mathbf{x}_1, \dots, \mathbf{x}_N)$ and consequently, a state-dependent Laplacian $\mathbf{L}(\mathbf{x}_1, \dots, \mathbf{x}_N)$. The resulting generalized connectivity is also able to embed mild formation control constrains and obstacle avoidance if needed. Exogenous control actions coming from human operators or from a distributed target visiting algorithm, like the one presented in (Nestmeyer et al. 2016), can be also included. Using a feedback-force collaborative scheme one or more human operators can interact with the group of robots and immersively feel, through haptics, the connectivity force generated by the group.

Connectivity alone might be not enough to achieve certain tasks in which the robots can rely on relative sensing only. In these cases it is more appropriate to consider the concept of rigidity

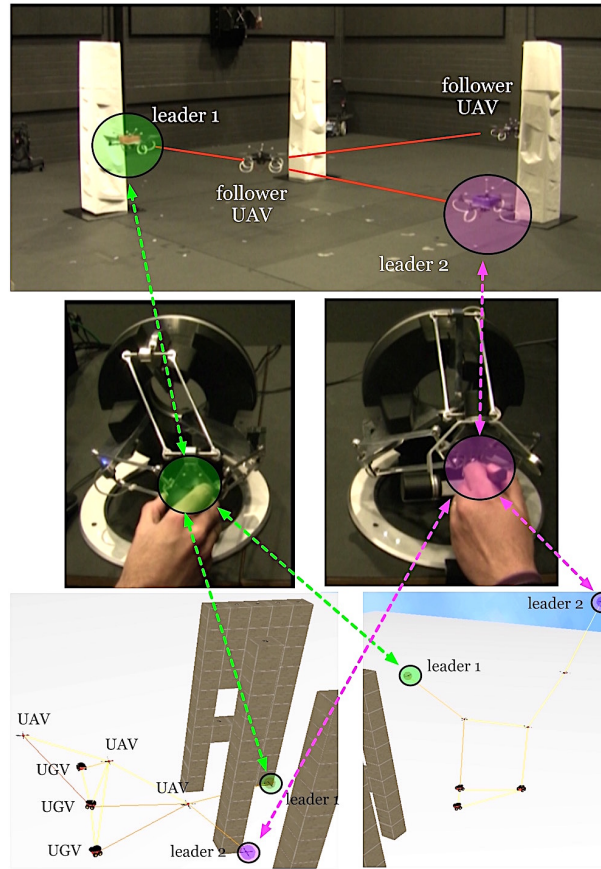

Figure 3.10: Experiments and simulations involving two operators controlling groups of mobile robots in a generalized connectivity preservation scheme (Robuffo Giordano et al. 2013).

instead, which defines the property of being able to instantaneously reconstruct the group shape using local relative measurements, such as relative distances or relative angles. The rigidity concept has been originally introduced in the structure theory in order to characterize the notion of flexibility and stiffness of rigid-body structures.

The main algebraic object of what is called infinitesimal rigidity (Zelazo et al. 2014) is the so called rigidity matrix $\mathbf{R}(\mathcal{G}, \mathbf{p}_1, \dots, \mathbf{p}_N)$ which is defined as

$$\mathbf{R}(\mathcal{G}, \mathbf{p}_1, \dots, \mathbf{p}_N) = [\mathbf{E}_l(\mathcal{G}_1)^T \dots \mathbf{E}_l(\mathcal{G}_N)^T] (\mathbf{I}_N \otimes [\mathbf{p}_1^T \dots \mathbf{p}_1^T]^T)$$

where $\mathbf{E}_l(\mathcal{G}_i)$ is the local incidence matrix relative to the i -th robot, \mathbf{I}_N is the $N \times N$ identity matrix, and \otimes denotes the Kronecker product between matrices.

In the context of multi-robot systems, the authors of (Zelazo et al. 2014) develop a theoretical machinery to express the degree of rigidity using a single non-negative number, namely the rigidity eigenvalue, defined as the smallest non-structurally-zero eigenvalue of the symmetric rigidity matrix

$$\mathcal{R} = (\mathbf{W}(\mathbf{p}_1, \dots, \mathbf{p}_N) \mathbf{R}(\mathcal{G}, \mathbf{p}_1, \dots, \mathbf{p}_N))^T (\mathbf{W}(\mathbf{p}_1, \dots, \mathbf{p}_N) \mathbf{R}(\mathcal{G}, \mathbf{p}_1, \dots, \mathbf{p}_N))$$

where \mathbf{W} is the diagonal matrix of the state-dependent weights defined on the edges of \mathcal{E} . The authors in (Zelazo et al. 2014) present a distributed algorithm that ensures the preservation of the

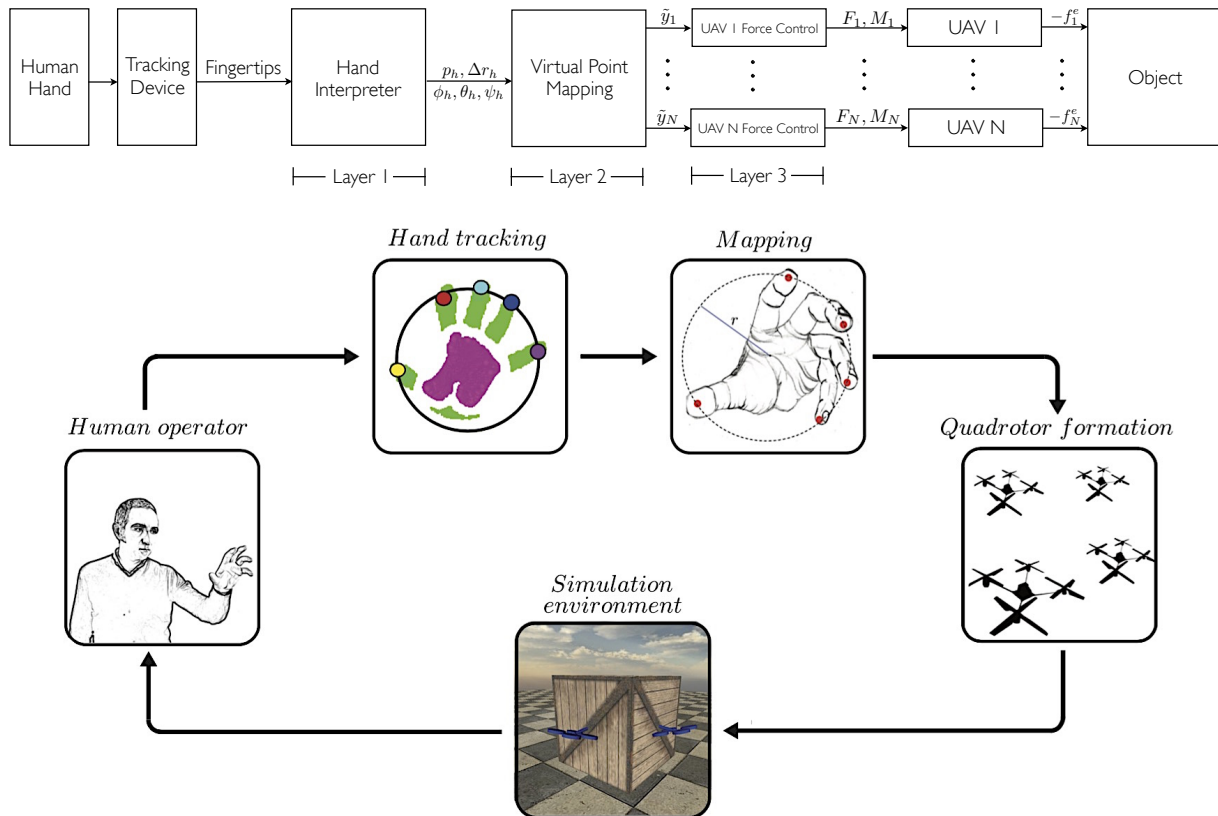

Figure 3.11: Block diagrams of the flying hand collaboration concept. Each aerial robot acts as a single finger to grasp an object and the is teleoperated by a human hand through the use of a suitable abstraction layer (Gioioso et al. 2014a).

rigidity resorting to local relative distance measurements only. Experiments are shown in which multiple human operators can interact with the group of robots providing velocity references while the group of aerial robots preserves the required degree of rigidity in an autonomous way. As in the connectivity case, haptic cues can be used to perceive the group rigidity using the feedback-force scheme.

Another advanced way of establishing a collaboration between human and the robotics team in the group-property preservation schemes is to let the human finely control the index that defines the group properties as, e.g., the connectivity and the rigidity eigenvalues, using one of the DoFs of the interface. A work that explores this idea in a feedback-force fashion for the connectivity index is presented in (Secchi et al. 2013).

3.5.5 Physical Interaction with Contact

We have already shown examples of coordination of ground robots physical interaction with contact, such as, e.g., (Lee and Spong 2005; Lee, Martinez-Palafox, and Spong 2005). Many other works are present in the literature for the ground mobile robot case which are not mentioned here. On the other side, human collaborative control of multiple aerial robots performing physical interaction with contact is a very young research field and not many works have been considering this scenario at date.

In (Gioioso et al. 2014a) it is proposed a control framework to let a group of aerial robots grasp an

object in a way that each robot uses an attached rigid tool to establish a single contact, see Figure 3.11. Each robot acts as a flying finger that collaborates with the others to establish a N-fingered hand. In this way the aerial robots realize a unique hand-like system that can grasp and transport an object. The whole system is operated by a human hand using a two-layer approach. First the operator hand is tracked with an RGB-D camera and some features are extracted and mapped to virtual attraction points. Secondly the aerial robots use an impedance force control in order to track the virtual attraction points with some compliance thus enabling grasping and transportation. The approach is validated in simulation only.

Another approach that solves a similar problem from the robot cooperative side but it lacks of the human collaborative part, is presented in (Nguyen, Park, and Lee 2015). In this work multiple aerial robots are connected to an object using spherical joints and are used as thrust generators to cooperative manipulate the object in a physical interaction with contact scenario. The method, which is validated with experiments using a team of quadrotors as aerial robots, represents a promising building block for a possible extension to the human collaborative case.

3.6 Conclusions

In this chapter we have shown and compared several different ways available in the literature to design the human collaborative control of the motion of mobile robots, with particular emphasis on the aerial robot case. We have introduced a simple yet descriptive model for the robots and the human interfaces and we have proposed a list of fundamental axes for a proper classification of the collaborative scheme, including but not limited to the degree of autonomy, the presence of interaction force with the human or with the environment, the kind multi-robot schemes and many others.

The common denominator of all the classification axes proposed in this chapter is the presence of a human operator in the control loop. In fact, fully autonomous control algorithms are not in general easily extendable in order to cope with the presence of a human operator and at the same time to take the best out of this collaboration. The main goal of the chapter has been to introduce the reader and provide a first-level analysis on the several ways to effectively include human operators in the control of both single and multiple aerial mobile robots. A particular emphasis has been set on the aerial robots case, which is at date not yet fully explored and understood, and is among the most challenging cases in robotics.

A lot of problems remain still unsolved in this field, among of which is worth to mention the possibility to perform effective bilateral teleoperation of aerial manipulators, the possibility of relying on onboard sensing in any environmental situation, the ability to cope with the large uncertainty in the perception and control of bilaterally teleoperated aerial robots thus enabling their use in the real world for helping humans in the industry and in their everyday life.

Chapter 4

A Research Perspective: Control Issues for Autonomy and Interactivity in Decentralized Teams of Heterogeneous Robots

In this Chapter, which concludes the document, I present one of the research perspectives that I am currently pursuing and that I have only partially attained at date (I would roughly say that only 15% of what is written in this chapter has been already achieved).

4.1 Context, motivation and objectives

4.1.1 Context

Recent scientific and technological efforts have been intensely directed toward the development of complex cognitive systems able to perceive the surrounding environment, build elaborate models of it, reasoning and act on it, and finally being able to learn and adapt to its unpredictable changes. Robotics represents the meeting point of all these fundamental research topics that involve, among the others, computer science, electronics, mechanics, and neuroscience. It is widely believed that developments of Robotics will lead a major “paradigm shift” in the society, e.g., bringing to the next industrial revolution (Gates 2007).

The huge expectation in the future outcomes of Robotics justifies its pivotal role played in the EU funding program, as testified by the following excerpt taken from the work program “Cognitive Systems and Robotics”: “... a research and innovation agenda, aiming to develop artificial systems operating in dynamic real life environments, reaching new levels of autonomy and adaptability and interacting in a symbiotic way with humans ... strong focus on advanced robotics systems, given their potential to underpin the competitiveness of key manufacturing sectors in Europe and a wide range of innovative products and services across the economy ... address advanced robotics functionalities in e.g. manipulation / grasping, ... autonomy, adaptability, scalability and robustness in different types of environments, and interaction concerns such as safety, natural human-robot interaction and robot-robot

cooperation.”

Robotics research generates huge expectations non only in the EU. From he 2013 roadmap made in the US, one can read *“Robotics technology holds the potential to transform the future of the country and is likely to become as ubiquitous over the next few decades as computing technology is today”* (A Roadmap for US Robotics – From Internet to Robotics¹)

The main (and most challenging) robotic applications for the future are related to operation in unstructured environments, as, for example, to assist humans in normal life, as domestic coworkers, to be a support for the elderly, or to be employed in hazardous works, e.g., in emergency situations like search and rescue after an earthquake, tsunami, flooding, or a power plant breakdown. Given the aforementioned foreseen applications, future robots must be able to operate in a wide variety of unstructured scenarios: environments with very sparse information distribution (forests, oceans, mountains) as well as dense-informative environments where many humans, move, work, and live together (cities, houses, farms, highway networks).

Future robotic platforms will then require autonomy, i.e., the capability of: *i)* obtaining information about the environment through onboard sensing and local communication; *ii)* possessing high mobility; *iii)* operating for an extended period; *iv)* having an autonomous decisional ability under dynamic situations; *v)* being able to act and interact with a dynamic and sparse environment while quickly adapt to unforeseen changes and being resilient to single-point failures. Secondly, a seamless and proactive interaction with humans must be achieved. Thirdly, robotics platforms will need versatility, i.e., the ability to be multi-purpose, by exploiting redundancy, heterogeneity, and parallelizability. Lastly, all the properties of the robotic platform must be validated and verifiable. All these features will enormously extend the capabilities of the robotic platform but, on the other hand, dramatically increase the difficulty of design providing new challenges to the robotics researchers of the next future.

In this scenario, heterogeneous multi-robot systems (and systems of systems) are the only viable way to fulfill all the aforementioned challenges. In fact, the proper coordination of many diverse robots can lead to the fulfillment of arbitrarily complex tasks in a more robust and flexible way than single robots. Teams of multi-robots will take advantage of their number to perform, for example, complex manipulation and assembly tasks, or to obtain rich spatial awareness by suitably distributing themselves in the environment. Use of multiple robots, or in general distributed sensing/computing resources, is also at the core of the foreseen Cyber-Physical Society (Lee 2008) envisioning a network of computational and physical resources (such as robots) spread over large areas and able to collectively monitor the environment and act upon it.

4.1.2 Motivation and objectives

The motivating substrate of this research perspective is the idea that in the future we will live in a world pervaded by ubiquitous robots each one possessing different abilities, some of which are now only barely conceivable. These robots will be networked together and available mostly everywhere, like Wi-Fi networks nowadays. When needed they will temporarily form an *Autonomous Collaboration Group* (abbr. ACG or simply called ‘group’ in the following), i.e., a sort of ‘robotic joint venture’, in order to attain complex tasks that would be impossible to achieve by a single robot alone.

¹<https://robotics-vo.us/>

Heterogeneity of the ACG will be the only way to overcome the impossibility (and inappropriateness), for a single robot, of being equipped with all the tools and abilities that are needed to accomplish the many different possible complex tasks. If we imagine the task as a complex mosaic, heterogeneity will allow to aggregate many polychrome tesserae in order to produce the conceived depiction. With the aim of increasing even more its flexibility, the group of robots will resort also to customization of the abilities in the sense that the robots will autonomously select and 'dress' the abilities pieces (be they physical abilities, e.g., sensors and effectors, or computing or algorithmic abilities) that are needed for the particular task. Those ability pieces, in the form of material tools or 'immaterial skills' will be either found disseminated in the environment or transported by other robots (e.g., by ground robots provided with trailers to store the tools and manipulators to 'mount' them on the members of the ACG).

In this envisioned scenario, the different robots forming an ACG will act as a distributed robotic platform in order to let the group benefit from the strength of each single component. They will establish a local dedicated network in order to efficiently cooperate by means of decentralized information exchange and physical interaction (i.e., contact). They will share representations of the environment coming from different sources of information (thanks to their heterogeneous sensorial abilities) and take collective decisions exploiting local communication and distributed computation. They will also coordinate their movements and join their physical effort and actions on the environment in order to execute the actual part of the task. Following the paradigm of systems of systems, they will also keep the connection with the external world and, in particular, with the network of robots that are outside the group and possibly will form other ACGs. This connection will allow the group to retrieve 'more' global information about the environment, establish higher level cooperations with other ACGs, reorganize in a different group composition by removing old members and including new ones. The last possibility, in particular, will bestow the ACG increased versatility by making it able to adapt to possible task modifications and structural changes of the 'boundary conditions' in the environment.

Another fundamental component of my vision is the fact that the heterogeneous group will be able to seamlessly and proactively interact with the humans. Humans will interact with the group in several possible ways: they will be able to simply perform a 'task request' (and then implicitly trigger the initiation of a new ACG); they will then have the possibility, if needed, to supervise the task execution and to help the group from a high-level point of view, by using suitable interfaces provided by the group itself (e.g., using 'interfacing robots'); they will also be able to closely collaborate with the team in the form of physical co-workers. On the other side, the last, unavoidable, form of interaction will be to actively minimize the interference with humans unrelated to the task that are just sharing the same space with the ACG.

Driven by this future scenario, in this research perspective one should consider the case of a broad interconnection of several ACGs, i.e., groups of locally networked robots. Each group is constituted by many heterogeneous robots that agreed on collaborating for a common task. Heterogeneity will result from a large number of different aspects, such, e.g., working environment (indoor, outdoor, ground, aerial, marine, underwater, . . .), kinematics and dynamics, mobility and reachable workspace, sensorial equipment, communication throughput, computational ability, size, weight, energy, battery autonomy, physical interaction tools (effectors), degree of safety in the interaction w.r.t. humans.

The *interplay between autonomy and interactivity* is a nodal point for this research perspective. In the context of this research perspective, 'interaction' and 'interactivity' must be intended with their original meaning of "reciprocal action or influence", i.e., regarding the ACG scenario, as the concept

of controlling a group of heterogeneous robots in order to obtain collaborative task achievement with humans. Furthermore, 'autonomous' must be interpreted in the sense described in Sec. 4.1.1, and not as 'isolated' or 'alone'. Given these clarifications in the definitions it is straightforward to understand that there is no contradiction between research on autonomy and research on interaction with humans. The more a robotics system is interactive the more it must be autonomous, especially when one considers task achievement. Furthermore, the more the system with which the robots are interacting is complex the larger is the needed degree of autonomy of the robots: deep collaborative interaction with such a complex system represented by a human being requires then an extreme degree of autonomy.

Guided by the understanding that achievement of human-free autonomy is preliminary to attainment of human-interactive autonomy, we divide the topics of this research perspective into two 'symbiotic' research areas. The first one deals with the aspects related to autonomy for collaborative groups of robots, while the second one faces the more challenging aspects related to interactivity with groups of robots. Before describing the two areas in detail in Sec. 4.2 and 4.3, respectively, we shall present the methodological objectives that are common to all the research topics of both areas. The remaining objectives that are peculiar of a specific topic will be introduced in the corresponding sections.

Common objectives of the research perspective The first primary objective common to all the topics of this research will be to design algorithms able to control the heterogeneity, i.e., exploit at most heterogeneity in order to achieve an indefinitely extendable set of tasks ranging (in order of needed autonomy and complexity) from human-assisted tasks to human-free tasks, up to the most challenging case of human-assistive tasks. Decentralization will be another primary objective in this research, i.e., property of *i*) being free of any central processing unit, *ii*) control every local action using only locally available information, and *iii*) limit the amount of computational resources w.r.t. the number of robots in the group (e.g., FLOPS, memory size, communication bandwidth). The last primary objective is the need to design and empirically validate systems that are functional in real-world conditions and use only onboard sensors, i.e., that *i*) take into account the practical limitations of onboard sensors, such as noise, presence of outliers, limited range and resolution, ... *ii*) can control their actuation in presence of disturbances, such as aerial turbulence, unexpected contact forces, friction, motor failures, etc., and *iii*) are able to robustly cope with brittle wireless ad-hoc communications.

4.2 Autonomy for Groups of Heterogeneous Networked Robots

The first research area of this perspective is focused on modeling, design, and development of novel architectures and algorithms for human-free autonomous groups of heterogeneous networked robots that are able to move in a different domains and physically interact with their surrounding environment. Execution of advanced coordinated tasks in a complete autonomous way is the leitmotif of this research area.

The single research topics of this area are classified in three categories, described in detail in the following sections. In our opinion these categories are among the fundamental pillars for bridging the theory-practice gap in human-free autonomous robotics:

A. The perception and estimation category comprises sensor fusion, cooperative localization, mapping, and tracking, and is described in Sec. 4.2.1;

B. the planning and motion control category encompasses, cooperative task assignment, collaborative motion / coverage / monitoring, and is illustrated in Sec. 4.2.2;

C. the cooperative manipulation category includes cooperative grasping / transportation / manipulation, and coordinated physical interaction and is explained in Sec. 4.2.3.

4.2.1 Perception and Estimation

Perception and estimation of the state of a robotic platform and the surrounding world are the first, foundational, building blocks for guaranteeing the sought autonomy. In the context of this research perspective, the research topics of this category will act as a support work for all the remaining categories of the two research areas.

Additional objectives for this category A peculiar objective of this category (that adds up to the ones presented in Sec. 4.1.2) is to avoid to use any external motion capture systems. On the contrary one should resort only to sensors that are mounted on-board, and therefore are lightweight, inexpensive, and low power-consuming, like, e.g., monocular cameras, MEMS-based IMUs, sonars.

Main problems to be addressed in the category The first topic addressed in this category will be the mutual localization among the different robots, i.e., the estimation of the time-varying transformations between the frames attached to the main body of each robot. This information is fundamental for any cooperative motion control strategy. We plan to address this problem in the following way: i) by extending the analysis of the observability in the mutual localization problem to presence of heterogeneous sensors, e.g., in part distance-based, in part vision-based, altitude, velocity, acceleration etc.; iii) using the most suitable filtering technique in order to merge the information obtained from the different sensors, e.g., non-linear variants of the Kalman Filter, Monte Carlo Localization, PHD filters. The main issues here will be to take into account the several constraints given by the onboard sensors, in particular, to cope with the limited range and field-of-view, and the presence of outliers; and to ensure an algorithm complexity that will allow fast on-line processing and control in-the-loop.

The second topic will be to let some of the robots in the team to form a portable motion capture (tracking) system that will ensure a very accurate localization of a small portion of the environment. This ability will ensure an extremely precise control of the motion in that region that will be used to finely operate, e.g., to perform delicate physical interaction operations, like ultra-precise assembly. We plan to achieve this goal by: i) using the state-of-the-art feature tracking algorithms; ii) extending the theoretical concept of graph rigidity to the heterogeneous sensor case. Rigidity is related to the instantaneous geometric solvability of the localization problem, which allows a very fast and robust position reconstruction. One of the main challenges here will be to ensure a robust tracking of the part of interest (typically the effectors) despite the changing of the light conditions and the occlusions. For this purpose the use of active sensors with emitters mounted on the parts to be tracked might be considered.

The final topic will be to build, and continuously update, a multi-layered model of the surrounding dynamic environment, on the basis of the different typology of sensors carried by the robots. We will particularly focus on two aspects of this topic: i) employing the most recent vision-based dense reconstruction algorithms in a real-time context in order to ensure an agile collision-safe operation of the

multi-robot system; *ii*) address the problem of matching the perception of totally different sensors from different locations and working environments (e.g., vision, laser, temperature, density), e.g., addressing the air-ground matching problem.

4.2.2 Motion Planning and Control

The quality of a good perception and estimation algorithm can be fully exploited only when additional high level planning tasks and complex collective control maneuvers are performed by the robotic system. Along this line, we will direct my research toward some of the most relevant problems in the field of planning and control of the collective motion of a multiple and heterogeneous mobile robot system.

Additional objectives for this category In addition to the objectives discussed in Sec. 4.1.2, we will consider in this category the minimality of the available information. This concept is related to decentralization and, in a way, pushes decentralization to the extreme. An example of minimality that we will consider is when either a map of the environment or the exact positions in global coordinates are not available to the robot controllers. It has been proven that high level complex tasks can still be achieved by the group of robots in this challenging conditions (see, e.g., (Durham, Franchi, and Bullo 2012; Gagliardi et al. 2014)).

Main problems to be addressed in the category A first class of problems on which we will focus can be generically referred to as coverage problems, i.e., problems connected to the keeping of some part of the workspace under the perception range of the robots. The special case of coverage where the objective is to cover every point of an unknown environment at least once is commonly denoted with the term exploration. Whenever either a static or moving object has to be found in the environment the exploration is better denoted as a search problem. Finally, another important case is the persistent monitoring one, where the robots have to continuously sweep an environment minimizing some objective function, e.g., the maximum time a point of interest remains unvisited. We will address the coverage problems extending both the probabilistic (Burgard et al. 2005) and frontier-based (Franchi et al. 2009; Durham, Franchi, and Bullo 2012) approaches firstly to the use of on-board vision sensors and then to multiple heterogeneous sensors. We will also aim at addressing the persistent monitoring problem from a different perspective, i.e., by using the collective control strategies based on algebraic graph theory in the case of periodically connected networks.

Additionally, we will examine the wide category of collective motion control objectives in which the group of robots is forced to preserve a certain group-property during the task, i.e., to generate an invariant of the controlled group. An example of these properties is the maintaining the connectivity of the communication network while the main objectives are being achieved. We will consider mainly two cases of connectivity, *i*) continual connectivity, which prescribes that the network must stay connected at any time, and *ii*) periodical connectivity, which allows the temporary separation in distinct subnetworks enforcing only connection on an average time-basis. Other important cases of property-maintenance that we will develop are: *i*) to keep the observability/measurability of the system (e.g., its rigidity), *ii*) keeping a certain degree of redundancy in order to ensure robustness to single failures. Rigidity will be particularly useful in the case of ‘portable motion capture system’ depicted above. For example we will extend to the realistic case of noisy positioning information the methods presented in (Robuffo

Giordano et al. 2013; Zelazo et al. 2012), This objective will be pursued by applying the POMDP theory to the algebraic graph-theoretic concepts of spectrum of the Laplacian and Rigidity matrix.

Beside that, we will also aim at carrying out an analysis on the main fundamental properties of a group of heterogeneous robots, to design algorithms that allow to achieve some fundamental property for the group if they are not 'present' yet, e.g., connectivity achievement, rigidity achievement, robustness achievement, etc.

Finally we will consider the use of suitable adaptive control techniques in order to compensate for the change of the dynamical parameters of the robot whenever a sensor or effector is either mounted or unmounted;

4.2.3 Cooperative Manipulation

Physical interaction with the environment is a fundamental feature that will reveal the full potentiality of the envisaged heterogeneous multi-robot platform.

Additional objectives for this category There are no additional objectives for this category, but we stress that all the manipulation problem addressed in this category must be solved by resorting only to on-board sensors, in particular vision, proximity distance sensors, and force/contact sensors, rather than external and extremely accurate tracking and localization system.

Main problems to be addressed in the category Cooperative manipulation tasks will be firstly studied in order to allow for ordinary maintenance of the robots (e.g., empty battery substitution, which is an important problem especially for aerial robots). In parallel, we will also study manipulation tasks involving physical transformation of the surrounding environment. Typical case studies will be grasping, transportation, pushing, pick-and-place, assembly, construction, and other complex manipulation activities. Since aerial robots cannot count on ground reaction forces and are typically underactuated, we will also explore the designing of novel actuation paradigms enabling full-wrench actuation at the effector side, resulting in a more versatile tool for the interaction. For example we will consider the use of aerial rotorcraft with tilted, or tilting, propellers. we will also not restrain our research to interaction maneuvers that only consider the quasi-static case, but we will study new techniques for agile interaction maneuvers (e.g., seizing a flying object, or performing an aerial grasping of an objects that moves quickly on the ground). In general we will be particularly interested in fast physical interactions. Another crucial point will be to design control algorithms that are robust to unexpected contacts, that will happen more frequently when dealing with a crowded environment filled with several autonomous robots working in close vicinity.

Given its huge potentiality, this class of novel problems has recently drawn the attention of many studies, especially for the aerial case (Lindsey, Mellinger, and Kumar 2011; D'Andrea et al. 2011; AIRobots 2010-2013; ARCAS 2011-2015; AeRoArms 2015-2019). Nevertheless, this important results are still preliminary and the extraordinary potential of this field remains still unveiled. Among the main challenges, the specificity of each robot, e.g., payload and power, must be taken into consideration very carefully. Due to the presence of a physical interaction, a small decision errors might severely compromise the task and damage both the environment and the robotic platform. The approach must have to cope with the underactuation that it is typically present in aerial, marine, and underwater

robotic platforms. Nonholonomicity of ground robots must also be taken into account. Nevertheless, the biggest problem will be to cope with the uncertainty originated by the use of low-cost onboard sensors.

From a mechanical design point of view, we plan to use a wide set of interaction tools that will be mountable on each mobile robot, ranging from simple soft bumpers for pushing to grippers for direct grasping, actuated winches for cable pulling, and N-degrees-of-freedom (DOFs) manipulators for fine object handling. From a methodological point of view we will address those problems by resorting to nonlinear control theory tools, e.g., impedance control, passivity, and hybrid control. Approximation algorithm theory will be used to solve the problem of optimally choose which ability has to be ‘dressed’ by which robot, considering the given task and all the robot constraints. This issue will generate novel and challenging combinatorial optimization problems (a sort of ‘extended’ knapsack problems). In order to address the cooperative grasping problem we will also resort to the multifingered-hand control methodologies for grasping that allow for complete restraint, e.g., form closure and force closure controls. Optimal placement of the robots will be achieved through formation control techniques based on the graph-theoretical concept of rigidity and nonlinear control theory. Control techniques from visual servoing will also be exploited in order to finely adjust the placement of the effector, e.g., in case of hooking, insertion, etc. Finally, in order to address problem like agile grasping we will make use of both tools from optimal control, such as the Pontryagin’s minimum principle, and techniques based on both deterministic and probabilistic trajectory planning.

4.2.4 Summary and Relationship with our Research

In the previous sections we presented the perspective research topics pertaining autonomy for a group of heterogeneous networked robots. Even though the categories have been presented separately, all the topics of each category are completely interdependent one to the other. Just to give some examples: an effective perception and estimation needs control of the mobility in order to ensure observability, and manipulation in order, e.g., to mount the correct sensors; motion control needs estimation and equipment maintenance; manipulation needs a precise state estimation, and correct placement of the effectors.

In order to carry out the outlined research we will rely on our experience in the large majority of the fields involved by the single topics of this area. Concerning the tasks described in Sec. 4.2.1 we can count on our experience on: mutual localization of multiple robots ([Franchi, Oriolo, and Stegagno 2009b](#); [Franchi, Oriolo, and Stegagno 2010a](#); [Franchi, Oriolo, and Stegagno 2010b](#); [Stegagno et al. 2011](#); [Cognetti et al. 2012a](#); [Cognetti et al. 2012b](#); [Franchi, Oriolo, and Stegagno 2013](#); [Franchi et al. 2012b](#)), development of ground and aerial robotic platforms, with the related state estimation techniques ([Franchi et al. 2012c](#); [Spica et al. 2013](#); [Grabe et al. 2013](#); [Riedel et al. 2012](#)), intrinsic parameter estimation ([Censi et al. 2013](#)). Concerning the tasks described in Sec. 4.2.2 and 4.2.3 we will benefit from our research on: exploration with multiple robots ([Franchi et al. 2009](#); [Franchi et al. 2008](#); [Franchi et al. 2007a](#); [Franchi et al. 2007b](#)), search without map ([Durham, Franchi, and Bullo 2012](#); [Durham, Franchi, and Bullo 2010](#)), persistent (periodical) monitoring ([Pasqualetti, Franchi, and Bullo 2012](#); [Pasqualetti, Franchi, and Bullo 2010](#)), flexible connectivity and rigidity maintenance ([Robuffo Giordano et al. 2013](#); [Nestmeyer et al. 2013](#); [Robuffo Giordano et al. 2011a](#); [Zelazo et al. 2012](#); [Zelazo et al. 2014](#)), force feedback control and haptics ([Franchi et al. 2012b](#); [Franchi et al. 2012c](#); [Son et al. 2011b](#); [Lee et al. 2011](#)), aerial grasping ([Spica et al. 2012](#)), and

formation control ([Franchi et al. 2010](#); [Franchi et al. 2012b](#); [Franchi and Robuffo Giordano 2012](#)).

4.3 Interactions with Autonomous Groups of Heterogeneous Networked Robots

The second research area of this perspective is focused on the design and control of novel human-machine systems to interface humans with a group of autonomous heterogeneous robots operating in a real-world scenario, and on the development of new methodologies to establish a close physical interaction and cooperation of the robotic group with one or more humans. The leitmotif of this research area will be the study of effective and modern ways of interaction and cooperation with a team of heterogeneous robots that are ‘equal in rank’ with respect to the humans, i.e., they can count on their own independence, onboard sensing capabilities and autonomous planning and control.

As for research pertaining to the autonomy of networked robots, the single research topics of this area are classified in three categories, described in detail in the following sections. In my opinion, these categories corresponds to the three fundamental levels of interaction that humans will have in the future with the ubiquitous network of heterogeneous robots populating our world.

A. The interaction through interface category comprises shared control of group of heterogenous robots though haptic and tactile interfaces in unstructured environments, and is described in [Sec. 4.3.1](#);

B. the direct interaction category encompasses the tasks in which some humans and a heterogenous group of mobile robots are co-workers acting on the same objects , and is illustrated in [Sec. 4.3.2](#);

C. the unaware interaction category, explained in [Sec. 4.3.3](#), presents a prospective vision in which the robots are ‘erased’ from the scene and act as hidden actuators of the environment.

4.3.1 Interaction through Interfaces

The topics of this first category will allow to study new human-machine systems and interfaces to let the human and the robotic group mutually influence themselves in several innovative ways. Teleoperation, for example, falls in this category. Nevertheless our research in this field will aim at going beyond the standard teleoperation, as it will be clear from the list of addressed problems.

Additional objectives for this category Together with the common objectives considered in [Sec. 4.1.2](#), We will consider the possibility that additional ACGs (i.e., the Autonomous Collaboration Groups) will be created in order to interface between the human and the ACG the human has to interact with. In fact, if the interacting ACG is remotely located, then an additional ‘local’ ACG will be spontaneously created at the human site in order to provide him/her the appropriate human/machine interfaces that are needed to supervise or partially steer the execution of the task accomplished by the remote ACG (e.g., visual, haptic, auditive, etc.). Furthermore, the creation of additional ACG will happen spontaneously, whenever needed, in order to ensure the best connection between the remote and the local ACGs, for example in the case where one of the two groups cannot be in direct communication with the backbone of the network infrastructure. This mechanism will be useful in order to implement remote house-keeping, working in hazardous locations (nuclear plants, Arctic, jungle), search and rescue, exploration of zones that are remote (e.g., aerospace) or out-of-reach (e.g., oceans, caves, nanoscale

environments). However, the interaction through interfaces will also be useful in the case that the human and the interacting ACG co-exist in the same space. In this last case some of the robots of the ACG will provide to the human the needed interfaces.

Main problems to be addressed in the category We will investigate and propose innovative ways by which a human will be able influence the status of a group of heterogeneous robots. Reciprocally, We will consider visual, haptic, auditive, and tactile feedback as some of the means for increase the human situational awareness and provide a 'way back' in the mutually-influential connection between human and robots. We will heavily exploit the disproportion between the DOFs that a human can control simultaneously (just a few) and the many DOFs of a heterogeneous multi-robot system. Rather than being a limit, the dynamic and kinematic dissimilarity between human-ergonomic interfaces and the mobile robots will represent a source of inspiration and a spur for the creativity. For example we will consider the problem of mapping each finger of the human hand to the effectors of different mobile robots in the group in order to perform grasping. The recent theory of grasping synergies (Gabiccini et al. 2011) and the use of tactile feedback will be instrumental in this case. Some of the other ways that we will develop to interact with a large group of robots will be leader-follower interaction, based on the seminal inspiring work (Leonard and Fiorelli 2001), boundary control, i.e. containment of the group operational area, e.g., extending the ideas presented in (Ji et al. 2008), and flow-based interaction, i.e., allowing a human to change the gradient of the flow of the multi-robot system, interpreted as a fluid, e.g., using the theory developed in (Kingston and Egerstedt 2011). The notion of multi-robot manipulability introduced in (Kawashima and Egerstedt 2011) will also be a source of theoretical inspiration.

The use of interfaces to keep under control a machine, especially in a remote one, represented one of the biggest dream of the human kind in the past. In fact, teleoperation is a research topic that started before the first industrial robot was invented (Hokayem and Spong 2006). Nowadays, teleoperation is a mature topic that can benefit of the development of a plethora of advanced control techniques. Despite these maturity, shared control of multiple-, heterogeneous-, and mobile-, robots it is still a young research field (Franchi et al. 2012c; Franchi et al. 2012a; Franchi et al. 2012b) and a lot of work has to be done, yet, to make those system work in the real world and becoming an everyday experience for the common people.

4.3.2 Direct Interaction

This second category of interactions will contain problems in which one or more humans are collocated with the group of robots and physically operate on the same objects in direct cooperation with the robots.

Main problems to be addressed in the category We will consider several problems in which one or more human will be physical co-workers for a group of effectors-enabled mobile robots. We will for example consider cooperative transportation, pick and place, peg in hole, screwing, hitching, and assembling. A primary issue when dealing with robots sharing the same workspace with humans is the safety. This topic will not be the main focus of our research perspective, but our research will definitely take advantage of the expertise of LAAS within this field, see, e.g., (PHRIENDS 2006-2009; SAPHARI 2011-2015).

We will aim at designing control, planning, and optimization algorithms for the multi-robot part of the hybrid human-robot system. Main goals will be to: *i)* let the robots dynamically understand the task from the human physical action (e.g., pulling, pushing, keeping), *ii)* ensuring the achievement of the detected task and stability of the system under any possible human action, and *iii)* optimizing some meaningful criteria, e.g., optimizing the choice of the roles, minimize the human effort, minimize the risks, and provide extended human perception and situational awareness by physical action (e.g. opposing resistance to potentially dangerous maneuvers).

While a lot of research has been already done in the case of manipulators co-worker, we will direct most of our attention toward the more challenging case of aerial robots physically collaborating with humans. Just to give an example, We will consider the case in which some humans cooperate with aerial robots using poles and cables in order to build a given structure. a problem that has been studied considering only aerial robots (ARCAS 2011-2015).

The main challenge task to ensure the stability of such a complex and dynamically-interconnected system where some of the components (the humans) are very difficult to model as standard dynamical systems and might act in an unpredictable way. Among the methodologies that we will use there will be robust control, passivity, the use suitable observers and possibly classification algorithms in order to understand human intentions.

4.3.3 Unaware (Invisible) Interaction

The third category will consider research topics addressing concepts that are very prospective. Nevertheless it will shed light, in our opinion, to one of the more exciting application of future robotics.

In the first two interaction categories the group of robots is visible to the human, the human is aware of the robots, shares his/her control with them and has expectations about their actions. In this third category we will push forward the idea of interaction with a group of autonomous robots and assume that they are completely hidden to the human(s). This 'masking' will be realized by resorting to wearable interfaces (e.g., active contact lens) that will display a 'reduced' portion of the reality (in contrast to the 'augmented' reality) where each robot is 'erased' and the portions of the environment that are not directly visible because of the occlusions caused by the robots are reconstructed in 3D using the vision systems of the robots themselves and integrated by the wearable display system.

Since the human is unaware of the presence of the robots he/she will act as if there were no robots in his/her neighborhood. The robots will then act as 'invisible ghosts' and will be able to 'animate' the passive object of the environment. This will open for a way of *flexibly and transparently automatizing the whole surrounding environment*. When the robots will move some object, it will appear as the object is moving by itself, i.e., it will be as if the object is 'actuated'. For example: when the human extends an arm toward a distant object then the object will automatically 'fly' into the hand; when the human pushes with a finger a table covered by unstable objects then the table will move without almost any effort from the human side and the objects will not fall down, because the 'ghost' robots will provide this kind of 'properties' to the table.

This scenario will disclose a completely new world of ways of interfacing a human with its surrounding environment. For example the human will be able to redefine the dynamical properties of the surrounding world, to change the masses of the objects, the direction, intensity and shape of the gravitational field, to create new force fields in the environment that will directly depend on his/her actions (finger movements, gaze, expert manipulation of some interface).

The advantages of this approach with respect to either the automation of each single part of the environment (as in the goals of domotics) or having a single visible helping robot (like a housekeeping robot) are that this approach will provide much more flexibility, customizability, and transparency. Humans will act in a ‘magic’ environment that will obey to ‘customized’ physics rules and they will get used to it, interaction with the environment will be much more direct and natural.

Notice that in some sense this category of interaction represents a fusion of the previous ones. In fact in this case there is both a close interaction and a mediation of the human-machine system that masks the robots from the environment. Therefore, it will present all the challenges of both problems plus many peculiar ones.

4.3.4 Summary and Relationship with our Research

In this research area we focused our attention on the fundamental aspect of interaction with an autonomous group of heterogeneous robots. We considered two complementary cases of controlling the interaction by means of suitable interfaces and ensuring a stable cooperation in the direct interaction. We also presented an exciting perspective research scenario that merges the two cases.

For this research area, in addition to all the research background already described in Sec. 4.2.4, We will also rely on our experience in shared control of multiple mobile robots ([Franchi et al. 2012c](#); [Franchi et al. 2012a](#); [Secchi et al. 2012](#); [Franchi, Masone, and Robuffo Giordano 2012](#); [Franchi et al. 2012b](#); [Riedel et al. 2012](#); [Franchi, Bülthoff, and Robuffo Giordano 2011](#)).

4.4 Conclusions

In this chapter we have presented a research perspective divided in two research areas revolving around the topic of controlling teams of heterogeneous robots. The first area is focused on modeling, design, and development of novel architectures and algorithms for human-free autonomous groups of heterogeneous networked robots that are able to move in a different domains and physically interact with their surrounding environment. The second area is focused on the design and control of novel human-machine systems to interface humans with a group of autonomous heterogeneous robots operating in a real-world scenario, and on the development of new methodologies to establish a close physical interaction and cooperation of the robotic group with one or more humans.

At date, only a little part of the work envisioned in this research perspective has been achieved, while a much larger part still remains for the future.

Bibliography

- AeRoArms (2015-2019). *EU Collab. Project ICT-644271*. www.aeroarms-project.eu.
- AIRobots (2010-2013). *EU Collab. Project ICT-248669*. www.airobots.eu.
- ARCAS (2011-2015). *EU Collab. Project ICT-287617*. www.arcas-project.eu.
- Burgard, W., M. Moors, C. Stachniss, and F. Schneider (2005). "Coordinated multi-robot exploration". In: *IEEE Trans. on Robotics and Automation* 21.3, pp. 376–386.
- D'Andrea, R., F. Augugliaro, M. Corzilius, C. Flores, M. Hamer, M. Hehn, S. Lupashin, C. Male, M. Mueller, and I. Thommen (2011). *Flying Machine Enabled Construction*. URL: http://www.idsc.ethz.ch/Research_DAndrea/fmec.
- Diolaiti, N. and C. Melchiorri (2002). "Teleoperation of a mobile robot through haptic feedback". In: *IEEE Int. Work. on Haptic Virtual Environments and Their Applications*. Ottawa, Canada, pp. 62–72.
- Farkhatdinov, I. and J. H. Ryu (2010). "Improving mobile robot bilateral teleoperation by introducing variable force feedback gain". In: *2010 IEEE/RSJ Int. Conf. on Intelligent Robots and Systems*. Taipei, Taiwan, pp. 5812–5817.
- Fiedler, M. (1973). "Algebraic connectivity of Graphs". In: *Czechoslovak Mathematical Journal* 23.98, pp. 298–305.
- Franken, M., S. Stramigioli, S. Misra, C. Secchi, and A. Macchelli (2011). "Bilateral telemanipulation with time delays: A two-layer approach combining passivity and transparency". In: *IEEE Trans. on Robotics* 27.4, pp. 741–756.
- Gabiccini, M., A. Bicchi, D. Prattichizzo, and M. Malvezzi (2011). "On the Role of Hand Synergies in the Optimal Choice of Grasping Forces". In: *Autonomous Robots* 31.2-3, pp. 235–252.
- Gates, B. (2007). "A Robot in Every Home". In: *Scientific American* 295.1, pp. 58–65.
- Hannaford, B. and J.-H. Ryu (2002). "Time-domain passivity control of haptic interfaces". In: *IEEE Trans. on Robotics and Automation* 18.1, pp. 1–10.
- Hokayem, P. F. and M. W. Spong (2006). "Bilateral Teleoperation: An Historical Survey". In: *Automatica* 42.12, pp. 2035–2057.
- Hou, X. and R. Mahony (2013). "Dynamic kinesthetic boundary for haptic teleoperation of aerial robotic vehicles". In: *2013 IEEE/RSJ Int. Conf. on Intelligent Robots and Systems*. Tokyo, Japan, pp. 4549–4950.
- Hou, X., R. E. Mahony, and F. Schill (2016). "Comparative Study of Haptic Interfaces for Bilateral Teleoperation of VTOL Aerial Robot". In: *IEEE Trans. on Systems, Man and Cybernetics: Systems*. URL: <http://arxiv.org/abs/1305.5719>.
- Ji, M., G. Ferrari-Trecate, M. Egerstedt, and A. Buffa (2008). "Containment Control in Mobile Networks". In: *IEEE Trans. on Automatic Control* 53.8, pp. 1972–1975.
- Kawashima, H. and M. Egerstedt (2011). "Approximate Manipulability of Leader-Follower Network". In: *50th IEEE Conf. on Decision and Control*. Orlando, FL, pp. 6618–6623.
- Kingston, P. and M. Egerstedt (2011). "Distributed-Infrastructure Multi-Robot Routing using a Helmholtz-Hodge Decomposition". In: *50th IEEE Conf. on Decision and Control*. Orlando, FL, pp. 5281–5286.

- Lee, D., O. Martinez-Palafox, and M. W. Spong (2005). “Bilateral teleoperation of multiple cooperative robots over delayed communication network: application”. In: *2005 IEEE Int. Conf. on Robotics and Automation*. Barcelona, Spain, pp. 366–371.
- Lee, D. and M. W. Spong (2005). “Bilateral teleoperation of multiple cooperative robots over delayed communication network: theory”. In: *2005 IEEE Int. Conf. on Robotics and Automation*. Barcelona, Spain, pp. 360–365.
- Lee, D. J. and K. Huang (2010). “Passive-Set-Position-Modulation Framework for Interactive Robotic Systems”. In: *IEEE Trans. on Robotics* 26.2, pp. 354–369.
- Lee, E. A. (2008). “Cyber-Physical Systems: Design Challenges”. In: *2008 11th IEEE Int. Symp. on Object Oriented Real-Time Distributed Computing*. Orlando, FL, pp. 363–369.
- Leonard, N. E. and E. Fiorelli (2001). “Virtual leaders, artificial potentials and coordinated control of groups”. In: *40th IEEE Conf. on Decision and Control*. Orlando, FL, pp. 2968–2973.
- Lindsey, Q., D. Mellinger, and V. Kumar (2011). “Construction of Cubic Structures with Quadrotor Teams”. In: *2011 Robotics: Science and Systems*. Los Angeles, CA.
- Mersha, A. Y., S. Stramigioli, and R. Carloni (2012). “Switching-based Mapping and Control for Haptic Teleoperation of Aerial Robots”. In: *2012 IEEE/RSJ Int. Conf. on Intelligent Robots and Systems*. Vilamoura, Portugal, pp. 2629–2634.
- Mersha, A. Y., X. Hou, R. Mahony, S. Stramigioli, P. Corke, and R. Carloni (2013). “Intercontinental haptic teleoperation of a flying vehicle: A step towards real-time applications”. In: *2013 IEEE/RSJ Int. Conf. on Intelligent Robots and Systems*. Tokyo, Japan, pp. 4951–4957.
- Mesbahi, M. and M. Egerstedt (2010). *Graph Theoretic Methods in Multiagent Networks*. 1st ed. Princeton Series in Applied Mathematics. Princeton University Press. ISBN: 9780691140612.
- Nguyen, H.-N., S. Park, and D. J. Lee (2015). “Aerial Tool Operation System using Quadrotors as Rotating Thrust Generators”. In: *2015 IEEE/RSJ Int. Conf. on Intelligent Robots and Systems*. Hamburg, Germany, pp. 1285–1291.
- Niemeyer, G., C. Preusche, and G. Hirzinger (2008). “Telerobotics”. In: *Springer Handbook of Robotics*. Ed. by B. Siciliano and O. Khatib. Springer, pp. 741–757.
- Omari, S., M. D. Hua, G. J. J. Ducard, and T. Hamel (2013). “Bilateral Haptic Teleoperation of VTOL UAVs”. In: *2013 IEEE Int. Conf. on Robotics and Automation*. Karlsruhe, Germany, pp. 2385–2391.
- PHRIENDS (2006-2009). *EU Collab. Project STReP IST-045359*. <http://www.phriends.eu/>.
- Rodríguez-Seda, E. J., J. J. Troy, C. A. Erignac, P. Murray, D. M. Stipanović, and M. W. Spong (2010). “Bilateral Teleoperation of Multiple Mobile Agents: Coordinated Motion and Collision Avoidance”. In: *IEEE Trans. on Control Systems Technology* 18.4, pp. 984–992.
- SAPHARI (2011-2015). *EU Collab. Project FP7-ICT 287513*. <http://www.saphari.eu/>.
- Schill, F., X. Hou, and R. Mahony (2010). “Admittance mode framework for haptic teleoperation of hovering vehicles with unlimited workspace”. In: *2010 Australasian Conf. on Robotics & Automation*. Brisbane, Australia.
- Stramigioli, S., R. Mahony, and P. Corke (2010). “A novel approach to haptic tele-operation of aerial robot vehicles”. In: *2010 IEEE Int. Conf. on Robotics and Automation*. Anchorage, AK, pp. 5302–5308.
- Antonelli, G., E. Cataldi, P. Robuffo Giordano, S. Chiaverini, and A. Franchi (2013). “Experimental validation of a new adaptive control for quadrotors”**. In: *2013 IEEE/RSJ Int. Conf. on Intelligent Robots and Systems*. Tokyo, Japan, pp. 2439–2444.
- Censi, A., A. Franchi, L. Marchionni, and G. Oriolo (2013). “Simultaneous Maximum-likelihood Calibration of Odometry and Sensor Parameters”**. In: *IEEE Trans. on Robotics* 29.2, pp. 475–492.
- Cognetti, M., P. Stegagno, A. Franchi, G. Oriolo, and H. H. Bühlhoff (2012a). “3-D Mutual Localization with Anonymous Bearing Measurements”**. In: *2012 IEEE Int. Conf. on Robotics and Automation*. St. Paul, MN, pp. 791–798.
- Cognetti, M., P. Stegagno, A. Franchi, and G. Oriolo (2012b). “Two Measurement Scenarios for Anonymous Mutual Localization in Multi-UAV Systems”**. In: *2nd IFAC Work. on Multivehicle Systems*. Espoo, Finland.

- Durham**, J. W., **A. Franchi**, and F. Bullo (2010). “Distributed Pursuit-Evasion with Limited-Visibility Sensor Via Frontier-based Exploration”. In: *2010 IEEE Int. Conf. on Robotics and Automation*. Anchorage, AK, pp. 3562–3568.
- (2012). “Distributed Pursuit-Evasion without Global Localization via Local Frontiers”. In: *Autonomous Robots* 32.1, pp. 81–95.
- Franchi**, A. (2016). “Human-Collaborative Schemes in the Motion Control of Single and Multiple Mobile Robots”. In: *Trends in Control and Decision-Making for Human-Robot Collaboration Systems*. Ed. by Y. Wang and F. Zhang. Springer.
- Franchi**, A., H. H. Bühlhoff, and P. Robuffo Giordano (2011). “Distributed Online Leader Selection in the Bilateral Teleoperation of Multiple UAVs”. In: *50th IEEE Conf. on Decision and Control*. Orlando, FL, pp. 3559–3565.
- Franchi**, A., C. Masone, and P. Robuffo Giordano (2012). “A Synergetic High-level/Reactive Planning Framework with Application to Human-Assisted Navigation”. In: *2012 IEEE IROS Work. on Real-time Motion Planning: Online, Reactive, and in Real-time*. Vilamoura, Portugal.
- Franchi**, A., G. Oriolo, and P. Stegagno (2009a). *Mutual Localization in a Multi-Robot System with Anonymous Relative Position Measures*. Tech. rep. 1. Department of Computer and System Sciences Antonio Ruberti.
- (2009b). “Mutual Localization in a Multi-Robot System with Anonymous Relative Position Measures”. In: *2009 IEEE/RSJ Int. Conf. on Intelligent Robots and Systems*. St. Louis, MO, pp. 3974–3980.
- (2010a). “On the Solvability of the Mutual Localization Problem with Anonymous Position Measures”. In: *2010 IEEE Int. Conf. on Robotics and Automation*. Anchorage, AK, pp. 3193–3199.
- (2010b). “Probabilistic Mutual Localization in Multi-agent Systems from Anonymous Position Measures”. In: *49th IEEE Conf. on Decision and Control*. Atlanta, GA, pp. 6534–6540.
- (2013). “Mutual Localization in Multi-Robot Systems using Anonymous Relative Measurements”. In: *The International Journal of Robotics Research* 32.11, pp. 1302–1322.
- Franchi**, A., A. Petitti, and A. Rizzo (2014). “Distributed Estimation of the Inertial Parameters of an Unknown Load via Multi-Robot Manipulation”. In: *53rd IEEE Conf. on Decision and Control*. Los Angeles, CA, pp. 6111–6116.
- Franchi**, A., A. Petitti, and A. Rizzo (2015). “Decentralized Parameter Estimation and Observation for Cooperative Mobile Manipulation of an Unknown Load using Noisy Measurements”. In: *2015 IEEE Int. Conf. on Robotics and Automation*. Seattle, WA, pp. 5517–5522.
- Franchi**, A. and P. Robuffo Giordano (2012). “Decentralized Control of Parallel Rigid Formations with Direction Constraints and Bearing Measurements”. In: *51st IEEE Conf. on Decision and Control*. Maui, HI, pp. 5310–5317.
- (2016). “Online Leader Selection for Improved Collective Tracking and Formation Maintenance”. In: *Accepted to IEEE Trans. on Control of Network Systems* abs/1305.5719. URL: <http://arxiv.org/abs/1305.5719>.
- Franchi**, A., P. Stegagno, and G. Oriolo (2016). “Decentralized Multi-Robot Encirclement of a 3D Target with Guaranteed Collision Avoidance”. In: *Autonomous Robots* 40.2, pp. 245–265.
- Franchi**, A., L. Freda, G. Oriolo, and M. Vendittelli (2007a). “A decentralized strategy for cooperative robot exploration”. In: *ACM International Conference Proceeding Series, Proceedings of the 1st international conference on Robot communication and coordination*. Vol. 318. 7. Athens, Greece.
- (2007b). “A Randomized Strategy for Cooperative Robot Exploration”. In: *2007 IEEE Int. Conf. on Robotics and Automation*. Rome, Italy, pp. 768–774.
- Franchi**, A., L. Freda, L. Marchionni, G. Oriolo, and M. Vendittelli (2008). In: *10th Int. Conf. on Intelligent Autonomous Systems*. Baden-Baden, Germany, pp. 348–355.
- Franchi**, A., L. Freda, G. Oriolo, and M. Vendittelli (2009). “The Sensor-based Random Graph Method for Cooperative Robot Exploration”. In: *IEEE/ASME Trans. on Mechatronics* 14.2, pp. 163–175.
- Franchi**, A., P. Stegagno, M. Di Rocco, and G. Oriolo (2010). “Distributed Target Localization and Encirclement with a Multi-robot System”. In: *7th IFAC Symp. on Intelligent Autonomous Vehicles*. Lecce, Italy.

- Franchi**, A., P. Robuffo Giordano, C. Secchi, H. I. Son, and H. H. Bühlhoff (2011). “A Passivity-Based Decentralized Approach for the Bilateral Teleoperation of a Group of UAVs with Switching Topology”. In: *2011 IEEE Int. Conf. on Robotics and Automation*. Shanghai, China, pp. 898–905.
- Franchi**, A., C. Secchi, H. I. Son, H. H. Bühlhoff, and P. Robuffo Giordano (2012a). “Bilateral Teleoperation of Groups of Mobile Robots with Time-Varying Topology”. In: *IEEE Trans. on Robotics* 28.5, pp. 1019–1033.
- Franchi**, A., C. Masone, V. Grabe, M. Ryll, H. H. Bühlhoff, and P. Robuffo Giordano (2012b). “Modeling and Control of UAV Bearing-Formations with Bilateral High-Level Steering”. In: *The International Journal of Robotics Research, Special Issue on 3D Exploration, Mapping, and Surveillance* 31.12, pp. 1504–1525.
- Franchi**, A., C. Secchi, M. Ryll, H. H. Bühlhoff, and P. Robuffo Giordano (2012c). “Shared Control: Balancing Autonomy and Human Assistance with a Group of Quadrotor UAVs”. In: *IEEE Robotics & Automation Magazine, Special Issue on Aerial Robotics and the Quadrotor Platform* 19.3, pp. 57–68.
- Franchi**, A., R. Carli, D. Bicego, and M. Ryll (2016). “Full-Pose Geometric Tracking Control on SE(3) for Laterally Bounded Fully-Actuated Aerial Vehicles”. In: *Submitted to 55th IEEE Conf. on Decision and Control*. Las Vegas, NV.
- Gagliardi**, M., G. Oriolo, H. H. Bühlhoff, and A. **Franchi** (2014). “Image-based Road Network Clearing without Localization and without Maps using a Team of UAVs”. In: *13th European Control Conference*. Strasbourg, France, pp. 1902–1908.
- Gioioso**, G., A. **Franchi**, G. Salvietti, S. Scheggi, and D. Prattichizzo (2014a). “The Flying Hand: a Formation of UAVs for Cooperative Aerial Tele-Manipulation”. In: *2014 IEEE Int. Conf. on Robotics and Automation*. Hong Kong, China, pp. 4335–4341.
- Gioioso**, G., M. Ryll, D. Prattichizzo, H. H. Bühlhoff, and A. **Franchi** (2014b). “Turning a Near-hovering Controlled Quadrotor into a 3D Force Effector”. In: *2014 IEEE Int. Conf. on Robotics and Automation*. Hong Kong, China, pp. 6278–6284.
- Gioioso**, G., M. Mohammadi, A. **Franchi**, and D. Prattichizzo (2015). “A Force-based Bilateral Teleoperation Framework for Aerial Robots in Contact with the Environment”. In: *2015 IEEE Int. Conf. on Robotics and Automation*. Seattle, WA, pp. 318–324.
- Grabe**, V., M. Riedel, H. H. Bühlhoff, P. Robuffo Giordano, and A. **Franchi** (2013). “The TeleKyb Framework for a Modular and Extendible ROS-based Quadrotor Control”. In: *6th European Conference on Mobile Robots*. Barcelona, Spain, pp. 19–25.
- Lee**, D., A. **Franchi**, P. Robuffo Giordano, H. I. Son, and H. H. Bühlhoff (2011). “Haptic Teleoperation of Multiple Unmanned Aerial Vehicles over the Internet”. In: *2011 IEEE Int. Conf. on Robotics and Automation*. Shanghai, China, pp. 1341–1347.
- Lee**, D. J., A. **Franchi**, H. I. Son, H. H. Bühlhoff, and P. Robuffo Giordano (2013). “Semi-Autonomous Haptic Teleoperation Control Architecture of Multiple Unmanned Aerial Vehicles”. In: *IEEE/ASME Trans. on Mechatronics, Focused Section on Aerospace Mechatronics* 18.4, pp. 1334–1345.
- Masone**, C., A. **Franchi**, H. H. Bühlhoff, and P. Robuffo Giordano (2012). “Interactive Planning of Persistent Trajectories for Human-Assisted Navigation of Mobile Robots”. In: *2012 IEEE/RSJ Int. Conf. on Intelligent Robots and Systems*. Vilamoura, Portugal, pp. 2641–2648.
- Masone**, C., P. Robuffo Giordano, H. H. Bühlhoff, and A. **Franchi** (2014). “Semi-autonomous Trajectory Generation for Mobile Robots with Integral Haptic Shared Control”. In: *2014 IEEE Int. Conf. on Robotics and Automation*. Hong Kong, China, pp. 6468–6475.
- Michieletto**, G., A. Cenedese, and A. **Franchi** (2016). “Bearing Rigidity Theory in SE(3)”. In: *Submitted to 55th IEEE Conf. on Decision and Control*. Las Vegas, NV.
- Mohammadi**, M., A. **Franchi**, D. Barcelli, and D. Prattichizzo (2016). “Cooperative Aerial Tele-Manipulation with Haptic Feedback”. In: *Submitted to 2016 IEEE/RSJ Int. Conf. on Intelligent Robots and Systems*. Daejeon, South Korea.
- Nestmeyer**, T., A. **Franchi**, H. H. Bühlhoff, and P. Robuffo Giordano (2013). “Decentralized Multi-target Exploration and Connectivity Maintenance with a Multi-robot System”. Karlsruhe, Germany.

- Nestmeyer**, T., P. Robuffo Giordano, H. H. Bühlhoff, and A. **Franchi** (2016). “Decentralized Simultaneous Multi-target Exploration using a Connected Network of Multiple Robots”. In: *arXiv abs/1505.05441*. URL: <http://arxiv.org/abs/1505.05441>.
- Pasqualetti**, F., A. **Franchi**, and F. Bullo (2010). “On Optimal Cooperative Patrolling”. In: *49th IEEE Conf. on Decision and Control*. Atlanta, GA, pp. 7153–7158.
- (2012). “On Cooperative Patrolling: Optimal Trajectories, Complexity Analysis, and Approximation Algorithms”. In: *IEEE Trans. on Robotics* 28.3, pp. 592–606.
- Petitti**, A., A. **Franchi**, D. Di Paola, and A. Rizzo (2016). “Decentralized Motion Control for Cooperative Manipulation with a Team of Networked Mobile Manipulators”. In: *2016 IEEE Int. Conf. on Robotics and Automation*. Stockholm, Sweden.
- Rajappa**, S., M. Ryll, H. H. Bühlhoff, and A. **Franchi** (2015). “Modeling, Control and Design Optimization for a Fully-actuated Hexarotor Aerial Vehicle with Tilted Propellers”. In: *2015 IEEE Int. Conf. on Robotics and Automation*. Seattle, WA, pp. 4006–4013.
- Riedel**, M., A. **Franchi**, H. H. Bühlhoff, P. Robuffo Giordano, and H. I. Son (2012). “Experiments on Intercontinental Haptic Control of Multiple UAVs”. In: *12th Int. Conf. on Intelligent Autonomous Systems*. Jeju Island, Korea, pp. 227–238.
- Robuffo Giordano**, P., A. **Franchi**, C. Secchi, and H. H. Bühlhoff (2011a). “Bilateral Teleoperation of Groups of UAVs with Decentralized Connectivity Maintenance”. In: *2011 Robotics: Science and Systems*. Los Angeles, CA.
- (2011b). “Experiments of Passivity-Based Bilateral Aerial Teleoperation of a Group of UAVs with Decentralized Velocity Synchronization”. In: *2011 IEEE/RSJ Int. Conf. on Intelligent Robots and Systems*. San Francisco, CA, pp. 163–170.
- Robuffo Giordano**, P., A. **Franchi**, C. Secchi, and H. H. Bühlhoff (2013). “A Passivity-Based Decentralized Strategy for Generalized Connectivity Maintenance”. In: *The International Journal of Robotics Research* 32.3, pp. 299–323.
- Ryll**, M., D. Bicego, and A. **Franchi** (2016). “Mechanical Design and Control of FAST-Hex: a Fully-Actuated by Synchronized-Tilting Hexarotor”. In: *Submitted to 2016 IEEE/RSJ Int. Conf. on Intelligent Robots and Systems*. Daejeon, South Korea.
- Schiano**, F., A. **Franchi**, D. Zelazo, and P. Robuffo Giordano (2016). “A Rigidity-Based Decentralized Bearing Formation Controller for Groups of Quadrotor UAVs”. In: *Submitted to 2016 IEEE/RSJ Int. Conf. on Intelligent Robots and Systems*. Daejeon, South Korea.
- Secchi**, C., A. **Franchi**, H. H. Bühlhoff, and P. Robuffo Giordano (2012). “Bilateral Teleoperation of a Group of UAVs with Communication Delays and Switching Topology”. In: *2012 IEEE Int. Conf. on Robotics and Automation*. St. Paul, MN, pp. 4307–4314.
- (2013). “Bilateral Control of the Degree of Connectivity in Multiple Mobile-robot Teleoperation”. In: *2013 IEEE Int. Conf. on Robotics and Automation*. Karlsruhe, Germany.
- Son**, H. I., J. Kim, L. Chuang, A. **Franchi**, P. Robuffo Giordano, D. Lee, and H. H. Bühlhoff (2011a). “An Evaluation of Haptic Cues on the Tele-Operator’s Perceptual Awareness of Multiple UAVs’ Environments”. In: *IEEE World Haptics Conference*. Istanbul, Turkey, pp. 149–154.
- Son**, H. I., L. L. Chuang, A. **Franchi**, J. Kim, D. J. Lee, S. W. Lee, H. H. Bühlhoff, and P. Robuffo Giordano (2011b). “Measuring an Operator’s Maneuverability Performance in the Haptic Teleoperation of Multiple Robots”. In: *2011 IEEE/RSJ Int. Conf. on Intelligent Robots and Systems*. San Francisco, CA, pp. 3039–3046.
- Son**, H. I., A. **Franchi**, L. L. Chuang, J. Kim, H. H. Bühlhoff, and P. Robuffo Giordano (2013). “Human-Centered Design and Evaluation of Haptic Cueing for Teleoperation of Multiple Mobile Robots”. In: *IEEE Trans. on Systems, Man, & Cybernetics. Part B: Cybernetics* 43.2, pp. 597–609.
- Spedicato**, S., A. **Franchi**, and G. Notarstefano (2016). “From Tracking to Robust Maneuver Regulation: an Easy-to-Design Approach for VTOL Aerial Robots”. In: *2016 IEEE Int. Conf. on Robotics and Automation*. Stockholm, Sweden.

- Spedicato**, S., G. Notarstefano, H. H. Bühlhoff, and A. **Franchi** (2013). “Aggressive Maneuver Regulation of a Quadrotor UAV”. In: *16th Int. Symp. on Robotics Research*. Tracts in Advanced Robotics. Singapore: Springer.
- Spica**, R., A. **Franchi**, G. Oriolo, H. H. Bühlhoff, and P. Robuffo Giordano (2012). “Aerial Grasping of a Moving Target with a Quadrotor UAV”. In: *2012 IEEE/RSJ Int. Conf. on Intelligent Robots and Systems*. Vilamoura, Portugal, pp. 4985–4992.
- Spica**, R., P. Robuffo Giordano, M. Ryll, H. H. Bühlhoff, and A. **Franchi** (2013). “An Open-Source Hardware/Software Architecture for Quadrotor UAVs”. In: *2nd IFAC Work. on Research, Education and Development of Unmanned Aerial Systems*. Compiègne, France.
- Staub**, N. and A. **Franchi** (2015). “Battery-aware Dynamical Modeling and Identification for the Total Thrust in Multi-rotor UAVs using only an Onboard Accelerometer”. In: *2015 IEEE Int. Conf. on Robotics and Automation*. Seattle, WA, pp. 3341–3346.
- Stegagno**, P., M. Cognetti, A. **Franchi**, and G. Oriolo (2011). “Mutual Localization using Anonymous Bearing-only Measures”. In: *2011 IEEE/RSJ Int. Conf. on Intelligent Robots and Systems*. San Francisco, CA, pp. 469–474.
- Stegagno**, P., M. Basile, H. H. Bühlhoff, and A. **Franchi** (2013). “Vision-based Autonomous Control of a Quadrotor UAV using an Onboard RGB-D Camera and its Application to Haptic Teleoperation”. In: *2nd IFAC Work. on Research, Education and Development of Unmanned Aerial Systems*. Compiègne, France.
- Stegagno**, P., M. Basile, H. H. Bühlhoff, and A. **Franchi** (2014). “A Semi-autonomous UAV Platform for Indoor Remote Operation with Visual and Haptic Feedback”. In: *2014 IEEE Int. Conf. on Robotics and Automation*. Hong Kong, China, pp. 3862–3869.
- Tognon**, M., S. S. Dash, and A. **Franchi** (2016). “Observer-based Control of Position and Tension for an Aerial Robot Tethered to a Moving Platform”. In: *IEEE Robotics and Automation Letters* 1.2, pp. 732–737.
- Tognon**, M. and A. **Franchi** (2015a). “Control of Motion and Internal Stresses for a Chain of Two Underactuated Aerial Robots”. In: *14th European Control Conference*. Linz, Austria, pp. 1614–1619.
- (2015b). “Nonlinear Observer-based Tracking Control of Link Stress and Elevation for a Tethered Aerial Robot using Inertial-only Measurements”. In: *2015 IEEE Int. Conf. on Robotics and Automation*. Seattle, WA, pp. 3994–3999.
- (2015c). “Nonlinear Observer for the Control of Bi-Tethered Multi Aerial Robots”. In: *2015 IEEE/RSJ Int. Conf. on Intelligent Robots and Systems*. Hamburg, Germany, pp. 1852–1857.
- Tognon**, M., A. Testa, E. Rossi, and A. **Franchi** (2016). “Exploiting a Passive Tether for Robust Takeoff and Landing on Slopes: Methodology and Experiments”. In: *Submitted to 2016 IEEE/RSJ Int. Conf. on Intelligent Robots and Systems*. Daejeon, South Korea.
- Yüksel**, B., G. Buondonno, and A. **Franchi** (2016). “Differential Flatness and Control of Protocentric Aerial Manipulators with Mixed Rigid- and Elastic-Joints”. In: *Submitted to 2016 IEEE/RSJ Int. Conf. on Intelligent Robots and Systems*. Daejeon, South Korea.
- Yüksel**, B., N. Staub, and A. **Franchi** (2016). “Aerial Robots with Rigid/Elastic-joint Arms: Single-joint Controllability Study and Preliminary Experiments”. In: *Submitted to 2016 IEEE/RSJ Int. Conf. on Intelligent Robots and Systems*. Daejeon, South Korea.
- Yüksel**, B., C. Secchi, H. H. Bühlhoff, and A. **Franchi** (2014a). “A Nonlinear Force Observer for Quadrotors and Application to Physical Interactive Tasks”. In: *2014 IEEE/ASME Int. Conf. on Advanced Intelligent Mechatronics*. Besançon, France, pp. 433–440.
- (2014b). “Reshaping the Physical Properties of a Quadrotor through IDA-PBC and its Application to Aerial Physical Interaction”. In: *2014 IEEE Int. Conf. on Robotics and Automation*. Hong Kong, China, pp. 6258–6265.
- Yüksel**, B., S. Mahboubi, C. Secchi, H. H. Bühlhoff, and A. **Franchi** (2015). “Design, Identification and Experimental Testing of a Light-Weight Flexible-joint Arm for Aerial Physical Interaction”. In: *2015 IEEE Int. Conf. on Robotics and Automation*. Seattle, WA, pp. 870–876.

- Zelazo**, D., P. Robuffo Giordano, and A. **Franchi** (2015). “Bearing-Only Formation Control Using an SE(2) Rigidity Theory”. In: *54rd IEEE Conf. on Decision and Control*. Osaka, Japan.
- Zelazo**, D., A. **Franchi**, and P. Robuffo Giordano (2014). “Rigidity Theory in SE(2) for Unscaled Relative Position Estimation using only Bearing”. In: *13th European Control Conference*. Strasbourg, France, pp. 2703–2708.
- Zelazo**, D., A. **Franchi**, F. Allgöwer, H. H. Bühlhoff, and P. Robuffo Giordano (2012). “Rigidity Maintenance Control for Multi-Robot Systems”. In: *2012 Robotics: Science and Systems*. Sydney, Australia.
- Zelazo**, D., A. **Franchi**, H. H. Bühlhoff, and P. Robuffo Giordano (2014). “Decentralized Rigidity Maintenance Control with Range Measurements for Multi-Robot Systems”. In: *The International Journal of Robotics Research* 34.1, pp. 105–128.

Appendix A

(Franchi et al. 2009)

A. Franchi et al. (2009). “The Sensor-based Random Graph Method for Cooperative Robot Exploration”. In: *IEEE/ASME Trans. on Mechatronics* 14.2, pp. 163–175

Appendix B

(Franchi, Oriolo, and Stegagno 2013)

A. Franchi, G. Oriolo, and P. Stegagno (2013). “Mutual Localization in Multi-Robot Systems using Anonymous Relative Measurements”. In: *The International Journal of Robotics Research* 32.11, pp. 1302–1322

Appendix C

(Pasqualetti, Franchi, and Bullo 2012)

F. Pasqualetti, A. Franchi, and F. Bullo (2012). “On Cooperative Patrolling: Optimal Trajectories, Complexity Analysis, and Approximation Algorithms”. In: *IEEE Trans. on Robotics* 28.3, pp. 592–606

Appendix D

(Durham, Franchi, and Bullo 2012)

J. W. **Durham**, A. **Franchi**, and F. Bullo (2012). “Distributed Pursuit-Evasion without Global Localization via Local Frontiers”. In: *Autonomous Robots* 32.1, pp. 81–95

Appendix E

(Censi et al. 2013)

A. Censi et al. (2013). “Simultaneous Maximum-likelihood Calibration of Odometry and Sensor Parameters”. In: *IEEE Trans. on Robotics* 29.2, pp. 475–492

Appendix F

(Franchi, Stegagno, and Oriolo 2016)

A. Franchi, P. Stegagno, and G. Oriolo (2016). “Decentralized Multi-Robot Encirclement of a 3D Target with Guaranteed Collision Avoidance”. In: *Autonomous Robots* 40.2, pp. 245–265

Appendix G

(Franchi et al. 2012c)

A. Franchi et al. (2012c). “Shared Control: Balancing Autonomy and Human Assistance with a Group of Quadrotor UAVs”. In: *IEEE Robotics & Automation Magazine, Special Issue on Aerial Robotics and the Quadrotor Platform* 19.3, pp. 57–68

Appendix H

(Lee et al. 2013)

D. J. Lee et al. (2013). "Semi-Autonomous Haptic Teleoperation Control Architecture of Multiple Unmanned Aerial Vehicles". In: *IEEE/ASME Trans. on Mechatronics, Focused Section on Aerospace Mechatronics* 18.4, pp. 1334–1345

Appendix I

(Franchi et al. 2012a)

A. Franchi et al. (2012a). “Bilateral Teleoperation of Groups of Mobile Robots with Time-Varying Topology”. In: *IEEE Trans. on Robotics* 28.5, pp. 1019–1033

Appendix J

(Franchi et al. 2012b)

A. Franchi et al. (2012b). “Modeling and Control of UAV Bearing-Formations with Bilateral High-Level Steering”. In: *The International Journal of Robotics Research, Special Issue on 3D Exploration, Mapping, and Surveillance* 31.12, pp. 1504–1525

Appendix K

(Robuffo Giordano et al. 2013)

P. Robuffo Giordano et al. (2013). "A Passivity-Based Decentralized Strategy for Generalized Connectivity Maintenance". In: *The International Journal of Robotics Research* 32.3, pp. 299–323

Appendix L

(Zelazo et al. 2014)

D. Zelazo et al. (2014). “Decentralized Rigidity Maintenance Control with Range Measurements for Multi-Robot Systems”. In: *The International Journal of Robotics Research* 34.1, pp. 105–128

Appendix M

(Tognon, Dash, and Franchi 2016)

M. **Tognon**, S. S. Dash, and A. **Franchi** (2016). “Observer-based Control of Position and Tension for an Aerial Robot Tethered to a Moving Platform”. In: *IEEE Robotics and Automation Letters* 1.2, pp. 732–737