



HAL
open science

Contribution to a non intrusive long-term sleep monitoring based on wearable patches and an algorithmic classification method

Qiang Pan

► **To cite this version:**

Qiang Pan. Contribution to a non intrusive long-term sleep monitoring based on wearable patches and an algorithmic classification method. Micro and nanotechnologies/Microelectronics. INSA de Toulouse, 2021. English. NNT : 2021ISAT0010 . tel-03191905v2

HAL Id: tel-03191905

<https://laas.hal.science/tel-03191905v2>

Submitted on 12 Jan 2022

HAL is a multi-disciplinary open access archive for the deposit and dissemination of scientific research documents, whether they are published or not. The documents may come from teaching and research institutions in France or abroad, or from public or private research centers.

L'archive ouverte pluridisciplinaire **HAL**, est destinée au dépôt et à la diffusion de documents scientifiques de niveau recherche, publiés ou non, émanant des établissements d'enseignement et de recherche français ou étrangers, des laboratoires publics ou privés.



THÈSE

DOCTORAT DE L'UNIVERSITÉ DE TOULOUSE

Délivré par l'Institut National des Sciences Appliquées de
Toulouse

Présentée et soutenue par

Qiang PAN

Le 23 mars 2021

CONTRIBUTION À UNE SURVEILLANCE LONGITUDINALE DU SOMMEIL A DOMICILE BASÉE SUR DES PATCHS PORTABLES ET UNE MÉTHODE DE CLASSIFICATION ALGORITHMIQUE

Ecole doctorale : **GEET - Génie Electrique Electronique et Télécommunications :**
du système au nanosystème

Spécialité : **MicroNano Systèmes**

Unité de recherche :

LAAS - Laboratoire d'Analyse et d'Architecture des Systèmes

Thèse dirigée par

Eric CAMPO et Damien BRULIN

Jury

M. Dan ISTRATE, Professeur, BMBI, Université de Technologie, Compiègne, Rapporteur

M. Mounir MOKHTARI, Professeur, Institut Mines-Telecom (IMT), Paris, Rapporteur

Mme Fati NOURHASHEMI, Professeur, Purpan Hospital, Toulouse, Présidente

M. Claudine GEHIN, Maître de Conférences, INSA Lyon, Examineur

M. Anthony FLEURY, Maître de Conférences, Institut Mines-Telecom (IMT), Douai, Examineur

M. Eric CAMPO, Professeur, Université Toulouse Jean Jaurès, Directeur de thèse

M. Damien BRULIN, Maître de Conférences, Université Toulouse Jean Jaurès, Co-directeur of thèse

Abstract

Sleep is essential for human health. Bad sleep and sleep disorders have been increasingly prevalent and are gradually becoming a social problem that cannot be ignored. Considerable effort has been devoted to academic and industrial research and development on wireless body networks for sleep monitoring in terms of non-intrusiveness, portability and autonomy. First of all, this thesis reviews current research on sleep monitoring in order to know the current state of research and to collect insights for future work. Specific selection criteria were chosen to include articles in which sleep monitoring systems or devices are covered.

The contributions of the thesis are mainly focused on 3 areas:

- The implementation of a complete hardware architecture for sleep monitoring based on an IoT network. It is based on the development of embedded autonomous patches, on the body (chest, wrists, feet) to measure movements and temperature, and in the environment close to the subject to measure the ambient level (sound, luminosity, temperature). These wireless sensors collect data continuously during the night and automatically transmit them to a remote database for display on a dashboard for the doctor. Two applications have been designed: a web-based interface and an Android application. Laboratory tests demonstrated the technical feasibility.
- The proposal of two original methods for the classification of sleep stages (threshold-based methods and k-means clustering). In this work, the proposed algorithms use only non-dominant wrist acceleration data. The calculations lead to a classification into 4-sleep stages ("awake", "light sleep", "deep sleep" and "REM") for night sleep. We validate our methods by referring to the results obtained by two commercial devices "Fitbit" and "Withings Sleep Analyzer" and to subjective comments from volunteers on their feelings about the quality of their sleep. Changes in sleep quality were evaluated for different nights with two volunteers to verify the performance of the proposed algorithms.
- The proposal and definition of sleep indicators to describe the sleep state (sleep positions, sleep stages, snoring and periodic leg movements) and its quality via the calculation of a sleep score based on the duration of each sleep stage. Five volunteers were recruited for the tests. Over the 15 nights of testing, the proposed algorithm based on the k-means clustering showed superior or equivalent performance compared to the results of the "Fitbit" tool. In terms of sleep stage classification, the device was compared to the clinical gold standard (PSG polysomnography) on one subject during one night at the sleep unit of the Purpan Hospital in Toulouse. This work showed that it was possible to propose a light, non-intrusive and autonomous system of continuous sleep monitoring at home.

Keywords: *Sleep monitoring, wearable sensors, k-means, clustering, classification, sensing, Polysomnography*

Résumé

Le sommeil est essentiel pour la santé humaine. Les troubles du sommeil sont de plus en plus répandus et deviennent progressivement un problème social qui ne peut être ignoré. Des efforts considérables ont été consacrés à la recherche et aux développements académiques et industriels sur les réseaux corporels sans fil pour la surveillance du sommeil en termes de non-intrusivité, de portabilité et d'autonomie. Tout d'abord, cette thèse passe en revue les recherches récentes sur la surveillance du sommeil afin de connaître l'état actuel de la recherche et de recueillir des informations pour les travaux futurs. Des critères de sélection spécifiques ont été choisis pour inclure des articles dans lesquels les systèmes ou dispositifs de surveillance du sommeil sont couverts.

Les contributions de la thèse sont principalement axées sur 3 volets :

- La mise en œuvre d'une architecture matérielle complète pour la surveillance du sommeil basée sur un réseau IoT. Elle est basée sur le développement de patchs autonomes embarqués, sur le corps (poitrine, poignets, pieds) pour mesurer les mouvements et la température, et dans l'environnement proche du sujet pour mesurer le niveau ambiant (son, luminosité, température). Ces capteurs sans fil collectent des données en continu pendant la nuit et les transmettent automatiquement à une base de données distante pour les afficher sur un tableau de bord à l'intention du médecin. Deux applications ont été conçues : une interface web et une application Android. Des tests en laboratoire ont démontré la faisabilité technique.

- La proposition de deux méthodes originales pour la classification des stades du sommeil (méthodes basées sur les seuils et sur le partitionnement k-means). Dans ce travail, les algorithmes proposés n'utilisent que des données sur l'accélération du poignet non dominant. Les calculs conduisent à une classification en 4 stades de sommeil ("éveillé", "sommeil léger", "sommeil profond" et "REM-mouvement rapide des yeux") pour le sommeil nocturne. Nous validons nos méthodes en nous référant aux résultats obtenus par deux appareils commerciaux "Fitbit" et "Withings Sleep Analyzer" et aux commentaires subjectifs de volontaires sur leurs sentiments concernant la qualité de leur sommeil. Les changements dans la qualité du sommeil ont été évalués pour différentes nuits avec deux volontaires afin de vérifier la performance des algorithmes proposés.

- La proposition et la définition d'indicateurs de sommeil pour décrire l'état de sommeil (positions de sommeil, stades de sommeil, ronflements et mouvements périodiques des jambes) et sa qualité via le calcul d'un score de sommeil basé sur la durée de chaque stade de sommeil. Cinq volontaires ont été recrutés pour les tests pendant 15 nuits et les performances entre les deux algorithmes proposés ont été comparées aux résultats du dispositif "Fitbit". En termes de classification des stades de sommeil, le dispositif a été comparé au gold standard clinique (polysomnographie PSG) sur un sujet pendant une nuit à l'unité du sommeil de l'hôpital Purpan à Toulouse.

Ce travail a montré qu'il était possible de proposer un système léger, non intrusif et autonome de surveillance continue du sommeil à domicile.

Mots clés : *Surveillance du sommeil, capteurs portables, k-means, classification, détection, Polysomnographie*

Acknowledgement

First of all, I would like to warmly thank my supervisors, Professor Eric Campo and Associate Professor Damien Brulin for their trust, their encouragement and their constant advice. What I have acquired is not only research skills but also a know-how and a scientific rigor essential to the profession of researcher. I sincerely thank them for their reactivity during each of my solicitations whether it is for research questions or needs in material. This unfailing support has made my work very pleasant. Thank you, I feel very lucky to have been your student.

I would like to thank the members of my thesis committee, Professors Dan Istrate, Mounir Mokhtari for agreeing to report my work, Mrs. Fati Nourhashemi for accepting the role of jury president and associate professors Claudine Géhin and Anthony Fleury for reviewing my work.

I would also like to thank Dr. Debs from the Toulouse Hospital (Sleep Unit) for allowing me to perform tests at the hospital and thus compare my results with clinical data.

Finally, I would like to thank all the volunteers for their participation in the experimental tests and especially Mostapha Zitouni for his technical support during the development of the hardware architecture. This help allowed me to progress very quickly.

A thought also for my fellow doctoral students Ghazi and Louis who are currently in their thesis. Enjoy these good moments of enrichment.

Contents

Abstract	1
Résumé	3
Acknowledgement	5
Contents	7
List of Figures	11
List of Tables	15
Glossary	17
General introduction	21
Chapter 1. State of the art in sleep monitoring system (SMS)	25
1 Introduction.....	25
1.1 Background.....	25
1.2 Sleep Stages Scoring Rules.....	25
1.3 Sleep disorders.....	27
2 Materials and methods.....	29
2.1 Inclusion criteria for sleep monitoring systems search.....	29
2.2 Search methods and strategy.....	30
2.3 Results.....	30
3 Current issues with SMS.....	34
3.1 User needs, perception and acceptance.....	34
3.2 Effectiveness.....	35
3.3 Interoperability.....	36
3.4 Hardware and software considerations.....	36
3.5 Medical, wellness, quality of life benefits.....	37
3.6 Cost, psychological and socio-economic barriers.....	38
3.7 Privacy, ethics, and legal barriers.....	38
3.8 Impact of sleep monitoring systems on society.....	39
4 Sleep Monitoring System Features.....	39
4.1 Conventional SMS.....	39
4.1.1 PSG.....	39
4.1.2 EEG.....	40
4.1.3 ECG.....	42
4.2 Wireless body area network (WBAN).....	43
4.2.1 Introduction.....	43
4.2.2 Hardware implementation.....	43

4.2.3 Software and algorithm processing.....	45
4.2.4 Research prototypes.....	48
4.2.4.1 <i>Non-contact methods</i>	48
4.2.4.2. <i>Contact methods</i>	51
4.2.5 Commercial products.....	55
5 Conclusion.....	57
Chapter 2. Hardware architecture proposal for sleep monitoring	59
1 Introduction.....	59
2 Overall SMS architecture	59
2.1 How the system works?.....	60
2.2 Choice of wireless communication techniques.....	62
2.3 Hardware system	64
2.3.1 Sensors	65
2.3.2 Master board	66
Figure 14. Master board composition.	67
2.3.3 Gateway.....	67
2.3.4 Android application	70
2.4 Sleep monitoring modules	71
2.4.1 Chest module	71
2.4.2 Wrist module	72
2.4.3 Foot module.....	72
2.4.4 Ambient module (Luminosity and Temperature).....	73
2.4.5 Sound module	74
2.4.6 Heart rate and SpO2 module.....	74
3 Conclusion.....	75
Chapter 3. Definition and detection of sleep indicators	77
1 Introduction.....	77
2 Definition of sleep indicators	79
3 Algorithms for obtaining sleep indicators.....	80
3.1 Sleep position detection.....	80
3.2 Snoring detection.....	81
3.2.1 Method	82
3.2.2 Result	84
3.3 Periodic leg movements (PLM) detection.....	86
3.4 Skin temperature (fingers, toes and chest)	87
3.5 Ambient conditions (luminosity and temperature)	87
4 Conclusion.....	89

Chapter 4. Sleep stages classification based on wrist movements	91
1 Introduction.....	91
2 Data acquisition and preprocessing.....	91
2.1 Data preprocessing.....	92
3 Threshold method.....	94
3.1 Sleep and Awake discrimination	94
3.2 Deep sleep and Light sleep/REM discrimination.....	95
3.3 Light sleep/REM discrimination.....	96
3.4 Detection of falling asleep and waking up	96
3.5 Optimization processing	97
4 K-means method	98
4.1 K-means clustering	98
4.2 Feature extraction	98
4.3 Sleep stages clustering	99
4.3.1 Awake	101
4.3.2 Light sleep.....	101
4.3.3 Deep sleep.....	101
4.3.4 REM	101
4.4 Voting rule	102
5 Experimental results.....	103
5.1 Processing time	103
5.2 Falling asleep/waking up detection analysis.....	103
5.3 Sleep stages classification analysis	104
6 Sleep score.....	107
7 Performance evaluation compared to commercial products	112
7.1 Reference devices	112
7.2 New “Threshold” method	112
7.3 New “k-means” method	112
7.4 Experimental setup.....	113
7.5 Falling asleep and waking up detection.....	114
7.6 Cumulative duration of each sleep stage.....	114
8 Conclusion.....	120
Chapter 5. Performance evaluation based on the PSG gold standard.....	121
1 Introduction.....	121
2 Real test in-situ	121
2.1 Environmental conditions	122
2.2 Synchronization protocol.....	123

2.2.1 Synchronization between the five sleep monitoring devices	123
2.2.2 Synchronization between the five sleep monitoring devices and the PSG.....	126
3 Sleep stages classification performance compared to the PSG	126
3.1 Hypnogram data preparation	126
3.2 Results analysis	129
4 PLMS detection performance compared to the PSG	136
4.1 Introduction.....	136
4.2 Results and discussion	137
5 Links between skin temperature and hypnogram.....	138
5.1 Data processing	138
5.2 Results.....	138
6 Links between skin temperature and PLMS	139
6.1 Data processing	139
6.2 Results	139
7 Conclusion	141
General conclusion.....	142
Appendix I. Hardware implementation in different works.	147
References.....	151
List of Publications	163

List of Figures

Figure 1. Terminology used by R&K and AASM for sleep stages scoring.	26
Figure 2. Number of results in the field of research on sleep monitoring systems over the last 5-year period (2016 - 2020).	33
Figure 3. Sleep monitoring by PSG - National Heart Lung and Blood Institute (NIH), November 2013.....	40
Figure 4. Typical EEG pattern for different stages of sleep [64].....	41
Figure 5. Typical EEG wave types.	42
Figure 6. Illustration of HF and LF from PPI [93].	54
Figure 7. Overall architecture of the proposed sleep monitoring system.	60
Figure 8. Sequence diagram for local configuration.....	61
Figure 9. System components tested individually and combined.....	61
Figure 10. The final L.S.M system appearance.	62
Figure 11. Overall hardware architecture of the proposed SMS.	64
Figure 12. The sensor's basic electronic board. (a) Front side; (b) Back side.	65
Figure 13. Illustration of the master board location.....	66
Figure 14. Master board composition.2.3.3 Gateway.....	67
Figure 15. Composition of the Gateway (two versions available: Lora-Wifi and Lora-2G).....	68
Figure 16. Basic diagram of the Lora-WiFi Gateway.....	68
Figure 17. General operation of the gateway.....	69
Figure 18. Gateway state machine and data flow.	69
Figure 19. The interface of the Android Application “L.S.M”.....	71
Figure 20. Chest module.	72
Figure 21. Wrist module.	72
Figure 22. Foot module.....	73
Figure 23. Ambient module.	73
Figure 24. Sound module.....	74
Figure 25. Heart rate and SpO2 module.	75
Figure 26. Result of body position detected by our chest module for one night.	80
Figure 27. Real environment of the sound level recording.....	81
Figure 28. Sound level epoch with snoring, freezer noise and movement noise (top: sound level recorded by a commercial smartphone application “Do I Snore or Grind”; middle: sound level	

recorded by the smart module with microphone; bottom: power spectrum of the sound level recorded by the smart module with microphone).	83
Figure 29. Procedure for the detection of snoring epochs.	84
Figure 30. Snoring level provided by the commercial smartphone application “Do I Snore or Grind” (top) and the algorithm presented (bottom).	85
Figure 31. Snoring detection report screenshot.	86
Figure 32. PLMS detected by our foot module.....	87
Figure 33. Recording of night temperature in three body positions.	87
Figure 34. Recording of ambient temperature and brightness during the night.	88
Figure 35. Position of the smart module.	92
Figure 36. Overnight data preprocessing scheme.	93
Figure 37. Illustration of M, EM, PM for a same night.	94
Figure 38. Illustration of three thresholds in sleep stages discrimination.....	95
Figure 39. Procedure of sleep stages discrimination.	96
Figure 40. Example of result obtained with the “Threshold method” for a night.	97
Figure 41. Sleep stages classification result of four methods for two nights.	100
Figure 42. Proportion of each sleep stages obtained from four methods for two nights.	100
Figure 43. Procedure for sleep stages clustering.	102
Figure 44. Procedure for calculating the sleep score.	109
Figure 45. Flow chart of the “Mkm2” method.	113
Figure 46. Moments of falling asleep and waking up obtained by reference and “Threshold” method.	114
Figure 47. Bland-Altman's plots agreement for four sleep stages determined by the “T1” method. (a) awake; (b) light sleep; (c) deep sleep; (d) REM.	118
Figure 48. Bland-Altman's plots agreement for four sleep stages determined by the “T2” method. (a) awake; (b) light sleep; (c) deep sleep; (d) REM.	118
Figure 49. Bland-Altman's plots agreement for four sleep stages determined by the “5km2” method. (a) awake; (b) light sleep; (c) deep sleep; (d) REM.....	119
Figure 50. Bland-Altman's plots agreement for four sleep stages determined by the “Mkm2” method. (a) awake; (b) light sleep; (c) deep sleep; (d) REM.....	119
Figure 51. Environment conditions of the whole ward.....	122
Figure 52. (a) The volunteer with the PSG and our wristband on the body in hospital; (b) Schematic diagram of the corresponding location of the PSG sensors and our modules on the body [169].....	123

Figure 53. Five hand-held sleep monitoring devices.	124
Figure 54. Sequence to create the synchronization sign.	124
Figure 55. The synchronization sign in the movement level waveform of each module.	125
Figure 56. Synchronization sign between PSG and left foot module.	126
Figure 57. Hypnogram obtained from the PSG, Threshold and 5km2 methods.....	127
Figure 58. “DeltaFree EEG reader” software interface.	128
Figure 59. Illustration of obtaining a hypnogram of PSG from the “DeltaFree EEG reader” software.	129
Figure 60. Proportion of each sleep stage obtained from the PSG, threshold and 5km2 methods....	130
Figure 61. Confusion matrix of the four methods proposed.	132
Figure 62. Confusion matrix for the recognition of each sleep stage with the T1 method.....	133
Figure 63. Confusion matrix for the recognition of each sleep stage with the T2 method.....	133
Figure 64. Confusion matrix for the recognition of each sleep stage with the 5km2 method.	134
Figure 65. Confusion matrix for the recognition of each sleep stage with the Mkm2 method.	134
Figure 66. PLMS detected by our foot module.....	137
Figure 67. Synchronous comparison between SD3T and the PSG hypnogram. (a) Hypnogram obtained by PSG. (b) SD3T.	139
Figure 68. Synchronous comparison between DTt, DTf and PLM overnight.	140

List of Tables

Table 1. Keywords used for the literature search.	30
Table 2. Number of occurrences in the field of sleep monitoring system research over 5 years.	31
Table 3. Characteristics of each stage of sleep.	42
Table 4. Choice of sensor for different sleep monitoring works.	44
Table 5. Implementation of software or algorithm in various works.	45
Table 6. Correlation between high and low frequency PPIs (pulse-to-pulse intervals) and sleep stages.	54
Table 7. Technical parameters of commonly used wireless communication technologies.	63
Table 8. Technical information of sleep monitoring modules.	65
Table 9. Detected body position and corresponding abbreviation.	80
Table 10. Time spent in each sleeping position.	80
Table 11. Result of a sleep stage obtained from 10 identical 5km2 methods for one night.	103
Table 12. Number of sleep and wake-up detection results in different time difference ranges.	104
Table 13. Comparison of the four methods of sleep stages classification.	104
Table 14. Appropriate sleep duration for each generation.	107
Table 15. Proportion of normal sleep stages for young adults and adults.	108
Table 16. Definition of symbols.	108
Table 17. Sleep stage information of the night used to illustrate the calculation of the sleep score.	110
Table 18. Comparison of the results of the proposed methods and the reference.	115
Table 19. Measures of the cumulative duration of each sleep stage between the reference and the proposed methods.	117
Table 20. Cumulative duration (in min) of each sleep stage obtained from the PSG, threshold and 5km2 methods.	129
Table 21. Cohen's Kappa coefficient (κ) of the four proposed methods relative to the PSG.	132
Table 22. Assessment indexes for recognition of each sleep stage with the threshold and 5km2 methods.	136
Table 23. Number of PLMS distributed in each sleep stage.	138

Glossary

A

AASM: American Academy of Sleep Medicine

APP: Smartphone application

B

BCG: Ballistocardiography

BLE: Bluetooth Low Energy

BMI: Body Mass Index

BodyLAN: Body Local Area Network

C

CRF: Conditional Random Field

D

DAN: Disorders of arousal from NREM

DFT: Discrete Fourier Transform

DT: Decision Tree

E

ECG: Electrocardiogram

EEG: Electroencephalogram

EMG: Electromyography

EOG: Electrooculography

F

FIR: Finite Impulse Response.

G

GATT: Generic Attribute Profile

GDP: Gross Domestic Product

H

HF: High frequency

HMM: Hidden Markov Model

HR: Heart rate

I

IDE: Integrated Development Environment

L

LD: linear discriminant

LDA: linear discriminant analysis.

LF: Low frequency

LoRa / LoRaWAN: Long Range Wide Area Network

L.S.M: LAAS Sleep Monitoring

M

mHealth: mobile Health

MODWT: Maximal Overlap Discrete Wavelet Transform.

MW: Middleware.

N

NB-IoT: Narrowband Internet of Things

NC: Network controller

NIH: National Heart Lung and Blood Institute

NN: Neural Network.

NREM: Nonrapid Eye Movement.

NTC: Negative Temperature Coefficient

O

OECD: Organisation for Economic Co-operation and Development

OSA: Obstructive Sleep Apnea

P

PIR: Passive infrared

PLM: Periodic Leg Movements

PLMD: Periodic Limb Movement Disorder

PLMI: Periodic Leg Movements Index

PLMS: Periodic Leg Movements during Sleep

PPI: Pulse-to-pulse interval

PSG: Polysomnography

PSQI: Pittsburgh Sleep Quality Index

R

RBD: REM sleep Behavior Disorder

REM: Rapid Eye Movement

RF: Random Forest

RLS: Restless Legs Syndrome

RR interval: the interval between R waves of the ECG

S

SAX: Symbolic aggregate approximation.

SMS: Sleep Monitoring System

SOM: Self-Organizing Map.

SpO₂: Peripheral oxygen saturation

STD: Standard deviation

SVM: Support Vector Machine.

SWS: Slow Wave Sleep

SYEL: Electronic Systems

T

T/R: Transmit/Receive

V

VLF: Very low frequency

W

WBAN: Wireless Body Area Network

W-band: Wearable band

Wi-Fi: Wireless Fidelity

WLBAN: Wireless Local Body Area Network

WSN: Wireless Sensor Network

General introduction

With increasing social pressures and the ageing of the world's population, sleep problems are becoming more and more frequent and represent a social issue that cannot be ignored [1][2]. Health professionals consider sleep as an important indicator of health status, poor sleep quality is indeed likely to be a sign of many diseases [3]. Moreover, it could lead to serious health consequences and to other physical and mental illnesses if the problem lasts over time. Therefore, it is of great significance to keep track of the sleep quality through sleep monitoring in order to better understand causes and consequences and to prevent possible medical complications. Polysomnography (PSG) is currently the internationally recognized gold standard for sleep monitoring [4]. Indeed, PSG monitors many body functions, including brain activity (EEG), eye movements (EOG), muscle activity or skeletal muscle activation (EMG), heart rhythm (ECG), and limbs movement, during sleep. The PSG typically records, in a minimal configuration, 12 channels requiring 22 wires attached to the patient. Although the PSG provides the most complete and accurate sleep monitoring information, the various electrodes with wires are spread over almost the entire body during monitoring, causing great discomfort to the user during sleep. Therefore, PSG is a highly invasive means of sleep monitoring. In addition, PSG sleep monitoring must be performed in a specialized sleep monitoring unit in the hospital and it is usual to perform only one night of PSG monitoring for a patient. This prevents PSG from being a long-term sleep monitoring solution. However, people's sleep status can vary from night to night, so that long-term sleep monitoring is essential for reliable results. Clearly, it is unrealistic to think that long-term sleep monitoring can be achieved if the hospital is the only place where sleep monitoring can be done. The only condition to enable long-term sleep monitoring would be to move the monitoring site from hospital to patient's home.

With the rapid development of wireless sensor networks (WSNs) and BodyLAN technology, alternative wearable solutions for sleep monitoring have recently emerged. These systems suffer from several drawbacks such as unreliability, complexity, their price which remains quite high in most cases besides the fact that these systems do not allow monitoring of all parameters and cannot be compared with gold standards, PSG or EEG. Finally, existing professional systems do not allow for remote monitoring at home, nor easy remote control by physicians. As a result, the patient must periodically visit the hospital to see his doctor and undergo a short sleep observation test, something most patients are reluctant to do. Based on the rich techniques and experience gained in the study of the WLBAN (wireless local body area network) monitoring system in our laboratory LAAS-CNRS since 1990 [5][6][7], we are attempting in this project to provide an alternative solution to this

problem by proposing a complete networked sleep monitoring system which provides information that is as relevant as current standards and that meets the requirements of physicians, while easing the constraints imposed on patients.

The contributions of the thesis are mainly focused on 3 areas:

- The implementation of a complete hardware architecture for sleep monitoring based on an IoT network. It is based on the development of (1) embedded autonomous patches, on the body (chest, wrists, feet) to measure movements and temperature, and of sensors distributed in the environment close to the subject to measure the ambient conditions (sound, luminosity, temperature). These wireless sensors collect data continuously during the night and automatically transmit them to a remote database for display on a dashboard for the doctor. Two applications have been designed: a web-based interface and an Android application. Laboratory tests demonstrated the technical feasibility.
- The proposal of two original methods for the classification of sleep stages (threshold-based methods and k-means clustering). In this work, the proposed algorithms use only non-dominant wrist acceleration data. The calculations lead to a classification into 4-sleep stages ("awake", "light sleep", "deep sleep" and "REM") for night sleep. We validate our methods by referring to the results obtained by two commercial devices "Fitbit" and "Withings Sleep Analyzer" and to subjective comments from volunteers on their feelings about the quality of their sleep. Our algorithms calculate the cumulative duration of each sleep stage to evaluate changes in sleep quality between different nights. Two volunteers carried out tests for 7 and 10 nights to verify the performance of the two algorithms.
- The proposal and definition of sleep indicators that will make it possible to describe the sleep state (sleep positions, sleep stages, snoring and periodic leg movements) and its quality via the calculation of a sleep score based on the duration of each sleep stage. Five volunteers were recruited for the tests. Over the 15 nights of testing, the proposed algorithm based on the k-means clustering showed superior or equivalent performance compared to the results of the "Fitbit" tool. In addition, to evaluate the performance of the proposed system in terms of sleep stage classification, we compared our device to the clinical gold standard PSG (Polysomnography) on a subject during one night at the sleep clinic of the Purpan hospital in Toulouse.

The manuscript consists of five chapters:

In Chapter 1, we present the state of the art of the sleep monitoring system. This review investigates the use of various common sensors in the hardware implementation of current SMS (Sleep Monitoring System), as well as the types of parameters collected, their positions on the body, the possible description of sleep phases, and their advantages and drawbacks. In addition, the data processing algorithms and software used in different SMS solutions, as well as their results are presented. This review is not limited to the academic research studies, but also investigated various commercial products available for sleep monitoring, presenting their characteristics, advantages and disadvantages. In particular, we categorized existing research on SMS based on how sensors are used, including the number and type of sensors, and preferred positions on the body. In addition to focusing on a specific system, issues related to SMS, such as privacy, economic and social impact, are also discussed.

Chapter 2 describes the hardware architecture of our proposed SMS. Detailed technical information on all components of the SMS, including the sleep monitoring modules, the master board, the gateway and the smartphone application is presented. Besides, we explain how the system works and justify our choice of wireless communication solutions.

Chapter 3 presents sleep indicators by referring to the Pittsburgh Sleep Quality Index (PSQI) which includes sleep stages, sleep positions, snoring, periodic leg movements during sleep (PLMS), distal skin temperature (fingers, toes) and proximal skin temperature (chest), ambient conditions (luminosity and temperature). Meanwhile, it describes the algorithms proposed to obtain these sleep indicators.

Chapter 4 presents the original sleep monitoring algorithms, including threshold and k-means clustering algorithms. All the algorithms proposed use only acceleration data acquired by our wrist module with a 3-axis accelerometer, allowing the detection of falling asleep and waking up and classification into 4-sleep stages (“awake”, “light sleep”, “deep sleep” and “REM”). We validate the proposed methods by comparing them to the results of the commercial products “Fitbit Charge 2” and “Withings Sleep Analyzer”. Based on wrist movement data collected during 32 nights of sleep from a total of 6 volunteers, we can show that the algorithms achieve promising results. Furthermore, we define a sleep score based on the duration of each sleep stage, which helps users without relevant sleep knowledge to intuitively understand their sleep.

In Chapter 5, we use PSG (Polysomnography) to follow the sleep of one of the volunteers throughout the night in a hospital’s professional sleep laboratory in order to evaluate the performance of the

algorithms proposed in chapter 4 in terms of sleep stage classification. Four confusion matrices are created to show the result. Performance assessment indexes such as Cohen's Kappa coefficient (κ), sensitivity, specificity, accuracy, precision, balanced accuracy and F1 score are calculated to assess performance from different perspectives. Besides, the links between skin temperature and hypnogram and between skin temperature and PLMS are also studied.

In conclusion, we will briefly remind the work carried out during these three and a half years of thesis and will highlight the main results obtained during the experiments. We will give research perspectives on the different aspects studied and a first reflection on the implementation of this type of device in current medical practices.

Chapter 1. State of the art in sleep monitoring system (SMS)

1 Introduction

1.1 Background

Sleep is crucial for human health and quality of life. Sleep corresponds to a decrease in the state of consciousness that separates two periods of wakefulness. It is characterised by a loss of alertness, a decrease in muscle tone and a partial preservation of sensory perception. Sleep is essential for many biological functions. Poor sleep and sleep disorders are increasingly prevalent among the world's older population [1][2]. The serious impact of sleep on health and well-being is the dominant motivation for sleep monitoring.

- On personal health, sleep is a foundation for good health as important as diet and exercise, according to the National Sleep Foundation. Poor sleep can lead to adverse health consequences, including obesity [8], cardiovascular disease [9], and depressive disorders [10]. Sleep is also associated with creativity [11], memory enhancement [12], and cognitive function [13]. Patients with sudden cardiac death and sleep disorders such as obstructive sleep apnea (OSA) have been reported to have peak mortality during sleep [14].
- On society, the incidence of sleep disorders appears to be a global concern. Among the world's population, 16.6% of people in Africa and Asia [15], 18% of people in Europe [3], and more than 20% of people in North America [16][17] are affected by nocturnal sleep disorders. Such prevalence has led to a series of societal problems, such as high rates of chronic diseases, road traffic accidents, and workplace accidents. Approximately 13% of work injuries are due to sleep problems [18]. In the United States, the expenditure for the treatment of moderate-to-severe sleep and related disorders amounts to US \$165 billion per year, far more than the cost of treating diseases such as heart failure, stroke, hypertension, and asthma, which ranges from US \$20 to US \$80 per year [19]. In five OECD (Organisation for Economic Co-operation and Development) countries, the economic costs of sleep deprivation represent 1.35% (Canada), 1.56% (Germany), 1.88% (United Kingdom), 2.28% (United States) and 2.92% (Japan) of their respective gross domestic product (GDP) [20].

1.2 Sleep Stages Scoring Rules

Schematically, sleep corresponds to a succession of 3 to 6 successive cycles, each lasting 60 to 120 minutes. A cycle is itself made up of an alternation of slow wave sleep and REM sleep, each

corresponding to different brain activities. Polysomnography (PSG) has long been considered as the gold standard for quantifying sleep time, differentiating sleep stages, and assessing sleep fragmentation. PSG provides comprehensive physiological information during sleep including electroencephalograms (EEGs), electrocardiograms (ECGs), electromyography (EMG), electrooculography (EOG), oral-nasal airflow, body position, thoracic and abdominal movements, pulse oximetry, and limb movements. Clinicians can obtain reliable sleep monitoring results, such as sleep stages, by analyzing the PSG recording during the night. For sleep stage guidelines and scoring rules, the R&K rules proposed by Rechtschaffen and Kales in 1968 [21] were used until 2007, when the American Academy of Sleep Medicine (AASM) updated the scoring manual commonly referred to as the AASM scoring manual [22]. The R&K rules and the AASM rules differ in the terminology used. The R&K rules divide sleep into 6 distinct stages: W (wake); non-rapid eye movement (non-REM [NREM]) stages S1, S2, S3, and S4; and REM sleep stage. The AASM rules recognize 5 sleep stages: W (wake) stage N1 (formerly stage 1 sleep), stage N2 (formerly stage 2 sleep), stage N3 (formerly stages 3 and 4 sleep), and stage R sleep (formerly stage REM sleep), as illustrated in Figure 1.

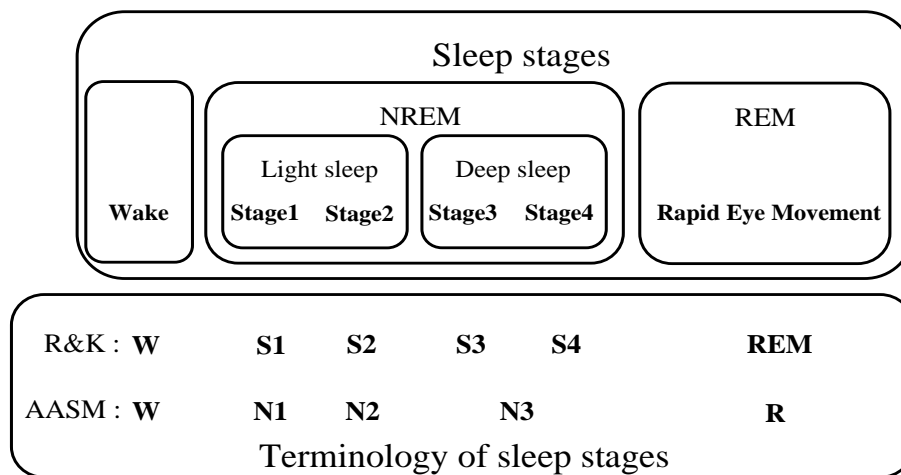

Figure 1. Terminology used by R&K and AASM for sleep stages scoring.

For the same sleep, the scoring results obtained from R&K rules and the AASM rules will be slightly different. One study [23] adopted both rules to score PSG sleep recordings of healthy subjects and patients (38 women and 34 men) aged 21 to 86 years. The results showed that sleep latency, REM latency, total sleep time, and sleep efficiency were not affected by the classification standard. In contrast, the time (in minutes and as a percentage of total sleep time) spent in stage 1 (S1/N1), stage 2 (S2/N2), and slow wave sleep (S3+S4/N3) differed significantly between the R&K and AASM classifications. Although light and deep sleep increased (S1 vs N1 [+10.6 min, (+2.8%)]: $P < .01$;

S3+S4 vs N3 [+9.1 min (+2.4%)]: $P < .01$), stage 2 sleep decreased significantly according to the AASM rules (S2 vs N2 [-20.5 min, (-4.9%)]: $P < .01$).

The differences between the results of the 2 sleep standards can be attributed to the different rules used [24].

The reader is reminded that sleep stages should not be considered as distinct entities but rather as a gradual transition of a waveform. Sleep usually follows a predictable pattern, moving cyclically between the light sleep stage, the deep sleep stage, and REM. Each sleep cycle typically lasts about 90 min and is repeated 4 to 6 times during the night. In each sleep cycle, people usually experience a transition from light to deep sleep first and then switch to REM. However, some stages can be skipped during sleep. For example, one can switch to REM or return directly to deep sleep from REM sleep [25]. Sleep quality is analyzed using standard parameters such as sleep efficiency, total sleep time, sleep latency, sleep stages 1 and 2, slow-wave sleep (sleep stages 3 and 4), rapid eye movement sleep, wake time after sleep onset, and nocturnal wake time [26].

1.3 Sleep disorders

The third edition of the International Classification of Sleep Disorders (ICSD-3), recently released, has identified 7 major categories of sleep disorders that include insomnia, sleep-related breathing disorders, central hypersomnolence disorders, circadian rhythm sleep-wakefulness disorders, sleep-related movement disorders, parasomnia, and other sleep disorders [27]. Most sleep disorders can be monitored by sleep monitoring systems, and some of them are detailed below:

- Insomnia refers to impairment in the quality and quantity of sleep. According to Ohayon [28], 10% to 30% of the adult population is affected by insomnia. The ICSD-3 criteria for this diagnosis include (1) a report of sleep initiation or maintenance problems, (2) adequate opportunity and circumstances for sleep, and (3) consequences during the day. The ICSD-3 duration criterion for chronic insomnia disorder is 3 months, and a frequency criterion (at least 3 times per week) was added.
- Sleep apnea is characterized by pauses in breathing or instances of shallow breathing during sleep [29]. Due to sleep apnea, the patient wakes up regularly throughout the night to retrieve breathing. Frequent awakening results in very poor quality of sleep and excessive daytime fatigue. Usually, sleep apnea may be accompanied by loud snoring, which can be easily monitored by a microphone (many researchers have studied Snoring signal processing-based methods to achieve a supplementary diagnosis way of sleep apnea) [30][31][32].

- Restless legs syndrome (RLS) is based on an urge to move the legs, sometimes accompanied by an uncomfortable sensation that (1) occurs primarily with rest or inactivity, (2) is partially or totally relieved by the movement, for as long as the movement occurs, and (3) occurs primarily in the evening or night [33]. Up to 30% of cases are caused by iron deficiency. These abnormal leg movements can be easily monitored with an accelerometer [34][35][36].
- Periodic limb movement disorder (PLMD) is characterized by abnormal limb movements and is responsible for deterioration in sleep quality [37]. For young people, it will be considered as pathologic when the index of periodic limb movement during sleep (PLMS; number of PLMS per hour) is greater than 5. For older people, an index of PLMS greater than 15 is usually adopted as the pathological threshold. This disorder can be detected by using EMG [38] or actigraphy [34].
- Disorders of arousal from NREM (DAN) include confusion arousal, sleepwalking, sleep terrors, and sleep-related breathing disorders [27][39]. The general criteria for disorders of arousal include (1) recurrent episodes of incomplete awakening, (2) absent or inappropriate responsiveness, (3) limited or no cognition or dream report, and (4) partial or complete amnesia for the episode. Detection of repeated wakes during the NREM stage can be a sign of DAN. This disorder can be detected using EEG.
- REM sleep behavior disorder (RBD) is characterized by the intermittent loss of REM sleep atonia and the appearance of elaborate motor activity associated with the situation in dreams, such as repeated episodes of behavior or vocalization resulting from REM [40]. When specific movements and sounds are detected during REM stage, RBD should be suspected. This disorder can be detected by using a microphone, actigraphy and an EEG.

Therefore, there appears to be a growing interest in researching new sleep monitoring system solutions to provide rapid, reliable, and long-term monitoring results to users and clinicians. Innovative home-used sleep monitoring systems offer users access to quality and sleep phases by themselves and can be a reference for the diagnosis of sleep disorders by clinicians.

For sleep monitoring, a sleep monitoring system can include a wide range of wearable or noncontact devices, including sensors, actuators, smart fabrics, power supplies, wireless communication networks, processing units, multimedia devices, user interfaces, software, and algorithms for data capture, processing, and decision support. These systems are able to measure vital signs, such as body and limb movements, body and skin temperature, heart rate, ECGs, EEGs, EMG, and respiratory rate. The measurements are transmitted via a network either to a central connection node,

such as a personal digital assistant, or directly to a medical center for storage, data processing, and decision making.

In order to discuss this potential, we thought it was important to review the current state of research and development in the field of sleep monitoring system, highlighting the main features of the most promising projects under development and future challenges.

2 Materials and methods

With the increasing occurrence of sleep disorders, the study of sleep monitoring systems has been one of the hotspots in the field of smart human monitoring. As a result, advances in sleep monitoring system development technology are constantly accelerating. Simple, lightweight, and small-size sensor systems are being adopted to acquire sleep-related physiological information. These systems are designed to be adaptable to the gold standard PSG, particularly with regard to sleep stages, sleep or wake, sleep apnea, sleeping positions, etc. In addition, the advantages of such a system over the traditional PSG method are that it is affordable, requires little or no technician intervention, is installed in the home, and can be used over the long term. The systems have undergone rapid development thanks to the progress made in the miniaturization of sensors, the reduction in energy consumption, and the various communication possibilities (Bluetooth, Wi-Fi, Sigfox, LoRa, and NB-IoT). These technologies allow today's sleep monitoring systems to be less intrusive and efficient, with remote and continuous monitoring. In this review, specific selection criteria are chosen as reference articles on sleep monitoring systems.

2.1 Inclusion criteria for sleep monitoring systems search

Most research projects on sleep monitoring systems have focused on smart, portable, and nonintrusive devices that encompass wireless communication, moving the monitoring site from the hospital to the home, in patch or contactless form. Systems that have the following features are included:

- Wearable, nonintrusive, wireless, and contactless.
- Patch, body sensor system, and sensor network.
- Band, watch, textile, bed sheet, and belt.
- Mobile, stationary, ambulatory, home and remote.

Automatic collection and transmission of acquired data and processing results can help physicians and caregivers easily monitor sleep conditions over time. In addition, it may be easier to find trends in the data, providing insight into individualized sleep patterns.

2.2 Search methods and strategy

This literature review focuses on the presentation of the hardware and software adopted in the current sleep monitoring system. We have included journal publications, conference publications, and information on related websites. The keywords for material collection are shown in Table 1. We conducted a keyword search in Web of Science, PubMed, and PubMed Central.

Table 1. Keywords used for the literature search.

Sleep	Long-term sleep monitor
Sleep quality	Sleep phase classification
Sleep monitor	Sleep stage classification
Sleep monitor system	Contactless sleep monitor
Sleep monitor and sensor	Nonintrusive sleep monitor
Sleep monitor and smart patch	Noninvasive sleep monitor
Sleep monitor and commercial products	Sleep big data
Sleep monitor at home	Sleep data mining
PSG	Sleep deep learning
EEG	Sleep machine learning
REM or light or deep sleep or wake	Sleep artificial intelligence

2.3 Results

Due to the large number of articles and abstracts retrieved, it was decided to include only articles published for the period 2016 to 2020 in Web of Science, PubMed, and PubMed Central. By counting the number of hits in the bibliographic database for each keyword, we can find search hotspots in this field and aspects that are still rarely covered. In this first search, we tried to find articles and abstracts, and websites with the keywords listed in Table 1. Keywords are used alone or combined using and, or operators. The article should report a clear description of the systems, the recipients or users requiring these systems, and issues related to sleep monitoring systems, including measured parameters, wireless sensor network (WSN), user needs and user acceptance. As this review is not an exhaustive presentation of the scientific literature in the field of sleep monitoring

systems, only a few representative sleep monitoring systems research and development projects or products from academia or industry are presented.

The number of hits in the sleep monitoring system research field between 2016 and 2020 is shown in Table 2.

Table 2 shows that the number of hits for the keywords sleep big data, sleep machine learning, sleep artificial intelligence, and sleep data mining is lower than the others. It would appear that techniques such as big data, machine learning, artificial intelligence and data mining have not been widely applied to the sleep monitoring research area, although they are now focused in other research areas. Therefore, the combination of these hotspot techniques with sleep monitoring may be a promising research direction and will attract more researchers in the future. To facilitate reading of the data in Table 2, a histogram is drawn, as shown in Figure 2.

Table 2. Number of occurrences in the field of sleep monitoring system research over 5 years.

Keywords	Web of Science	PubMed	IEEE Xplore
Sleep monitoring system	1606	1810	756
Sleep stage	4435	4920	499
Sleep phase	3747	2939	176
Light sleep	3796	2904	171
Deep sleep	1606	2086	356
REM	5568	3542	470
Sleep care	8277	18367	307
Sleep quality	20368	15539	637
Wearable device	16679	7678	6857
Assistive system	3259	36811	2519
Contactless monitoring	640	563	566
Nonintrusive monitoring	239	168	621
Noninvasive monitoring	5608	10888	1301
Smart patch	652	126	447
Medicine skin patch	108	983	25
Portable device	10956	6090	3350
eHealth	3660	18358	524
mHealth	4799	19055	442
Homecare	565	733	69
Telecare	520	745	70

Telemedicine	8959	15361	2084
Telemonitoring	974	845	152
Body sensor	13560	4306	7813
Body sensor network	3270	639	4093
Wireless sensor network	30322	2284	31289
Wireless sensor network wearable	815	162	1269
Body area network wearable	633	91	683
Personal area network	1808	23719	1435
Personal area network wearable	79	52	78
Sleep monitoring gold standard	151	326	50
PSG	2201	2557	399
EEG	32675	31203	7076
ECG	18739	26467	4815
Sleep, data processing	1794	1779	851
Sleep, big data	258	186	110
Sleep data mining	118	77	88
Sleep machine learning	644	515	336
Sleep artificial intelligence	94	461	456
User needs	58048	4617	17783
User acceptance	9588	2700	1235
User satisfaction	10905	1758	2177

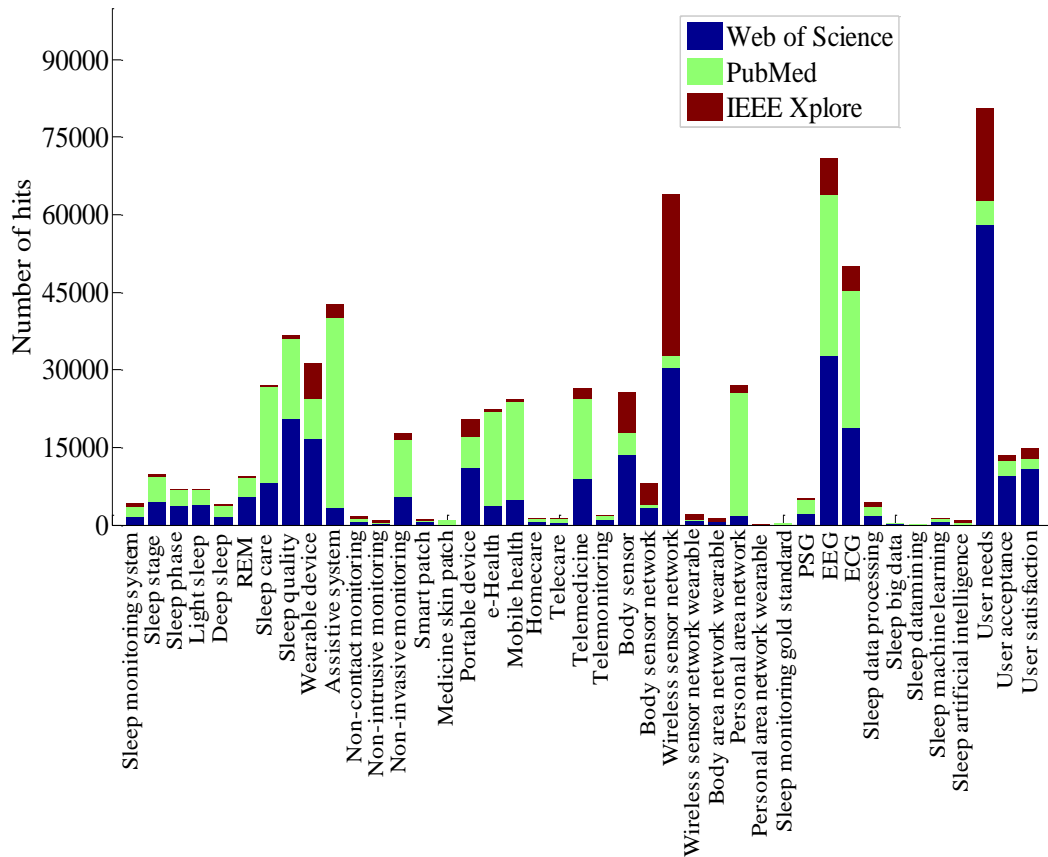

Figure 2. Number of results in the field of research on sleep monitoring systems over the last 5-year period (2016 - 2020).

The features and advantages of these hot techniques such as big data, artificial intelligence, machine learning and datamining make their applications in the field of sleep monitoring very promising.

Big data can be defined by 3 key concepts: volume, velocity, and variety. Volume refers to the amount of data generated and stored. In general, the larger the amount of data, the greater the statistical power for descriptive and predictive analysis. Applied to sleep monitoring systems, it could better describe sleep behavior and predict sleep-related disorders and health status. Velocity refers to the speed of data generation and processing. Big data are often available in real time. This makes it easier for people to get their sleep monitoring results in a timely manner, while helping subjects or medical staff to respond quickly to abnormalities and emergencies discovered during sleep monitoring. Finally, the term variety refers to different sources, types, and formats of data. Nowadays, more data types are being collected via sleep monitoring systems, including text, audio, image, and video data. Big data allow missing data to be completed through data fusion. This enables comprehensive sleep information to be obtained efficiently. In addition, big data can provide targeted information through the comprehensive and detailed collection of various relevant information, such as age, gender, BMI, place of residence, occupation, etc. For example, certain age groups, a certain

gender, people living in a certain location, people working in a certain profession, and people of a certain body type have a higher rate of poor sleep quality. Based on that observation, it is possible to organize more medical resources in certain areas, and at the same time, more attention in terms of sleep health can be given to some people who have a higher rate of poor sleep quality. This will improve the efficiency of the medical system.

Based on the large amount of data obtained through big data technology, techniques such as artificial intelligence, machine learning and data mining will be able to make full advantage of their benefits. Artificial intelligence refers to technology that presents human intelligence through computer programs. Machine learning uses data or previous experience to automatically improve the performance of specific algorithms. Data mining is a computational process that uses artificial intelligence, machine learning, statistics, and databases to discover patterns in relatively large data sets. In general, machine learning is considered a subset of artificial intelligence and consists mainly of data mining. As a tedious and repetitive task, sleep monitoring is well suited to the adoption of these promising and powerful approaches. When applying these approaches, it is more convenient and timely to obtain a large amount and variety of sleep-related data through the continued development of big data technology. This allows these approaches to be used to train more powerful models and to progressively extract higher-level features from the raw data to create a smarter, more efficient, and more convenient sleep monitoring systems. In summary, the combination of sleep monitoring and these hotspot technologies will certainly be the next exploration direction for researchers. Widespread application of these hotspot technologies in the field of sleep monitoring will be the future trend.

3 Current issues with SMS

3.1 User needs, perception and acceptance

A good sleep monitoring system should take into account user needs, perception, and acceptance before it is designed. User needs for sleep monitoring systems are diverse. These could include obtaining accurate and complete information about sleep. These needs could be met by professional medical instruments such as PSG and EEG. In addition, the user needs could also obtain auxiliary reference information, that is, only a small amount of key information such as sleep duration, number of awakenings, proportion of different sleep stages, and even only a summary of the sleep score. These needs are typically met by various apps in consumer electronics and smartphones with sleep monitoring functions. Compared to professional medical devices, this type of commercial product takes better account of the user's perception and is usually noninvasive, nonintrusive, or even

contactless. The user's perception of the sleep monitoring system is closely related to the number of electrodes or sensors attached to the body, the position, and the method of attachment to the body.

For the number of electrodes or sensors, the fewer the number, the better the user's perception. For the position of the attachment, it is preferable to attach it to the distal limbs such as the wrist, fingers, ankle, instep, and toes rather than to the main body, face and head. The method of attachment to the body can be with tape or a belt, such as a chest belt. In general, tape can give a better user perception than a belt because there is less surface contact with the body and less restraint on the body. User acceptance of sleep monitoring systems depends on the satisfaction of the user's needs and perception. Usually the satisfaction of the user's needs and the satisfaction of the user's perception are contradictory. In order to meet the user's needs as much as possible, more complete and accurate human physiological information needs to be collected, which often means attaching more sensors to more body positions which often aggravates the user's perception. Therefore, the design of a good sleep monitoring system has to find a compromise between user needs and user perception, which is usually related to ease of use while trying to meet the user's needs as much as possible.

3.2 Effectiveness

Although the PSG is the gold standard for sleep monitoring, it is expensive, highly invasive, and complicated to perform. PSG monitoring is not easily accessible, especially in developing countries [41]. Due to the many limitations of PSG, most people are only subject to PSG monitoring for one night. However, night-time monitoring is not sufficient to determine the actual sleep status. To improve effectiveness and obtain appropriate follow-up, long-term home monitoring is necessary.

Guettari et al [42] proposed a system based on a thermal sensor used over a long period of time to monitor changes in sleep quality and can be used at home and remotely consulted by sleep medicine experts. Changes in sleep quality derived from long-term monitoring are very useful in assessing sleep health. Using existing equipment daily for sleep monitoring is proving to be an effective approach, such as sleep monitoring using our smartphone router. Liu et al [43] proposed monitoring vital signs of breathing and heart rate during sleep using a single Wi-Fi access point (such as a router) and a single Wi-Fi device (PC or smartphone) without any wearable or dedicated devices. Thus, the system has the potential to be widely deployed and to provide continuous long-term monitoring. Smartphone apps are considered a good choice for large-scale, low-cost, and long-term sleep monitoring, which will improve efficiency and accuracy [25][44]. Sleep Hunter [45] is a mobile service that uses the built-in sensors of smartphones. It is implemented on the Android platform and can detect the transitions between sleep stages for monitoring sleep quality and the smart wake-up

call, which wakes up users in light sleep. The ability to perform long-term monitoring is important for the effectiveness of a sleep monitoring system. Long-term monitoring is essential for reliable results and early detection of abnormal sleep changes. To do this, sleep monitoring systems should be as inexpensive, easy to use, and easily accessible as possible.

3.3 Interoperability

Sleep monitoring devices are useful in health care. The value of these devices will increase if sleep monitoring system software apps can seamlessly collect medical data and upload them to a database. The ISO/IEEE11073 (X73) family of interoperability standards was originally designed for clinical point-of-care environments. The latest branch of X73, X73 for personal health devices (X73PHD), enables the development of interoperable personal health ecosystems and brings benefits to both technology producers (design cost reduction, experience sharing, and marketing facilities) and users (plug and play, accessibility, ease of integration, and price) [46]. OpenICE is an open source software project of the Massachusetts General Hospital's Plug-and-Play Medical Device Interoperability Program, which builds on much of research programs performed since 2004 to support four distinct user groups: use case demonstrations, clinical adoption, regulatory science, and commercial adoption [47]. Data sharing and interoperability are positive for users, researchers, physicians, and businesses. With the development and popularization of big data technology, improving interoperability is a hotspot in sleep monitoring system research and will be the trend for future developments.

3.4 Hardware and software considerations

The main hardware considerations for sleep monitoring system focus on 3 aspects: cost, comfort, and convenience, which could be the determining factors for acceptance of implementation. In terms of cost, the equipment should be affordable for most people. In addition, for devices that require frequent maintenance, such as the need for frequent replacement of specific components and the consumption of specific reagents or materials, their cost should be considered. For devices designed to use disposable batteries instead of rechargeable batteries, energy consumption should be taken into account, as frequent battery replacement will significantly increase the cost of use. In terms of comfort, contactless systems have the greatest advantage, but for contact systems, the emphasis is on wireless, miniaturization, and weight reduction. The comfort aspect includes ease of implementation and maintenance convenience. In terms of the convenience of implementation, daily implementation does not have to be complex and time-consuming. The main objective is to allow users to carry out

the application themselves without the intervention of professional technicians. In general, in terms of maintenance convenience, the longer the maintenance interval, the easier the operations are.

The main considerations for sleep monitoring system software are two-fold: effectiveness and efficiency. First, the sleep monitoring software must be able to effectively process the data collected to obtain the most accurate monitoring results. In terms of efficiency, this includes temporal efficiency and energy efficiency. It is very important for real-time sleep monitoring system processing takes into account temporal efficiency. The cost of execution time must be short enough to meet the real-time requirement.

For non-real-time sleep monitoring systems that process data after the end of monitoring, time efficiency is also of great importance. After sleep, users tend to be concerned about the results obtained. Waiting time will have an impact on the user experience, so the shorter the processing time, the better. Energy efficiency depends on 2 aspects: the optimization of the algorithm and the stand-by or wake programming for the hardware. If the algorithm can be well optimized, it will significantly reduce the energy consumption for the execution of the algorithm. Moreover, with reasonable stand-by or wake programming of the hardware, unnecessary energy consumption can be avoided.

3.5 Medical, wellness, quality of life benefits

Sleep quality is a crucial factor for human health and quality of life. The harmful effects of poor sleep quality and sleep disorders are increasingly recognized. Patients suffering from sleep disorders are prone to chronic diseases such as obesity, diabetes, and hypertension. The use of sleep monitoring systems could reduce the incidence of sleep-related illnesses, or illnesses could be predicted by sleep through long-term monitoring and trend analysis. McHill et al [48] demonstrated the relationship between obesity and sleep time. Lee et al [49] examined the impact of sleep quantity and sleep quality on blood glucose control in type 2 diabetes. Fuchs et al [50] showed that OSA is a clear risk factor for resistant hypertension. The application of sleep monitoring system can overcome infrequent clinical visits which may fail to detect transient events that predict dangerous future events. Early diagnosis through long-term trend analysis could prevent the potential severity of a disease. Such analyses could provide instant diagnosis of acute events, issue alerts to health care professionals, and reduce intervention time through teleradiology and teletherapy. Some typical sleep disorders, such as sleep apnea, restless leg syndrome, and periodic limb movement disorders can be detected in time through sleep monitoring. Unfortunately, people suffering from sleep disorders such as OSA tend to go undiagnosed [51] because they are usually unaware that sleep apnea has occurred.

This lack of symptom awareness during sleep is a serious health problem for modern life [52]. Early signs of these disorders could be monitored and treated with mild medication [53].

3.6 Cost, psychological and socio-economic barriers

Wireless patches, wristbands, chest belts, headbands, or other wearable devices that connect a sleeper to formal or informal caregivers, a data center or call center, who can then notify medical services in the event of abnormal sleep, are affordable and reliable. This technology has been available for more than 15 years, but despite its affordability [54], its adoption is minimal in almost all countries. Wearing permanent mobile health care devices and systems has psychological effects on patients. Significant barriers limit the widespread use of these systems due to the lack of studies which carry out test of smart wearable systems by end-users who give their feedbacks and preferences [55]. The high cost of current sleep monitoring system services limits their expansion. Wireless networks are another barrier to the deployment of sleep monitoring systems. Until the end of 2019, the global Internet penetration rate was only 58.7% [56]. As a result, access to services via internet is not always available. People with sleep disorders may have difficulties finding adequate sleep monitoring devices and services to support them monitor the quality of their sleep. Economic and social issues also need to be addressed to ensure that the market for sleep monitoring systems is open. A sound analysis of the costs and benefits of sleep monitoring systems has not been carried out. Some studies focus only on the technology and performance of the systems [44][57]. Socio-technical design science needs to be taken into account to ensure that sleep health care meets the needs of society. Ultimately, Coiera [58] argued that it is the beliefs and values of our culture that determine what we will create and what we will dream about. In total, there are 4 rules governing the design of health services: (1) technical systems have strong social consequences, (2) social systems have technical consequences, (3) we do not design technology; designing socio-technical systems does not just mean designing technology, and (4) the design of socio-technical systems must take into account how people and technologies interact.

3.7 Privacy, ethics, and legal barriers

With the continuous development of sleep monitoring technology, the collection of user information by the sleep monitoring system has become increasingly detailed and diverse. At the same time, it has gradually evolved from traditional night-time monitoring to long-term monitoring. This series of developments has improved the accuracy and reliability of sleep monitoring but has considerably increased the risk of leakage of user privacy information. To protect the privacy of users, the traditional method is to give informed consent before receiving sleep monitoring, and data collection

can only take place once the user has signed the informed consent. Consent is normally used to authorize a single study, and there are no specific regulations for data sharing in the research community. Given the high value and increasing popularity trend of big data applications, privacy issues related to data sharing need to be addressed urgently by legislators.

3.8 Impact of sleep monitoring systems on society

Sleep disorders affect a significant part of the population [3][15][16]. The socioeconomic consequences can be dramatic. These include drowsiness at the wheel, sleepiness at work, and cardiovascular disease [59]. Surantha et al [60] have argued that sleep quality monitoring is one of the solutions to maintaining sleep quality and preventing chronic diseases, mental problems, or accidents caused by sleep disorders.

Based on these considerations and issues, many types of sleep monitoring systems have been developed. The features of these are detailed in the following section.

4 Sleep Monitoring System Features

4.1 Conventional SMS

4.1.1 PSG

Polysomnography (PSG) is the gold standard in sleep assessment introduced in the 1960s as a tool for assessing sleep disorders. The subject equipped with a PSG is illustrated in Figure 3. A PSG records a minimum of 12 channels requiring a minimum of 22 wires attached to the patient. These channels vary in each laboratory and can be adapted to meet the physician's requirements. There are a minimum of 3 channels for the EEG, 1 or 2 measure for airflow, 1 or 2 are for chin muscle tone, 1 or more for leg movements, 2 for eye movements (EOG), 1 or 2 for heart rate and rhythm, 1 for oxygen saturation, and 1 is for each waist belt, which measures movements of the chest wall and upper abdominal wall. Belt movements are usually measured using piezoelectric sensors or respiratory inductance plethysmography. Breathing amplitude is often measured by the temperature changes that occur with breathing, as measured by a thermistor or thermocouple placed in the path of the airflow (nose and mouth). Body movements have been measured using the EMG. Oximetry is adopted to measure oxygen saturation levels in the blood by passing infrared light through the finger and measuring absorption patterns (made by the oxygen-carrying pigment, hemoglobin, in the blood). The body position sensor is used to distinguish between lying, standing, and lateral positions during sleep.

Although PSG provides the most accurate and objective measurement of sleep, specialized equipment, an elaborate facility, and dedicated and experienced PSG technologists are required to perform and analyze recordings, which are costly and labor intensive. This technique is not practical for large-scale and long-term sleep monitoring [61].

Figure 3 shows the standard configuration of a polysomnogram. In Figure 3, the patient lies in a bed with sensors attached to the body. In Figure 3, the polysomnogram recording shows the blood oxygen level, the respiratory event, and the REM sleep stage over time.

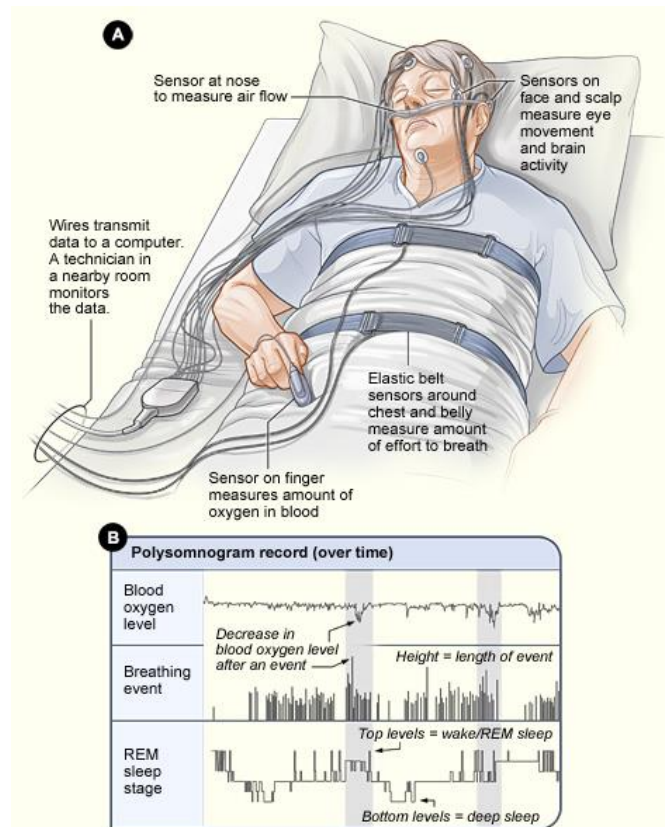

Figure 3. Sleep monitoring by PSG - National Heart Lung and Blood Institute (NIH), November 2013.

4.1.2 EEG

The EEG is an electrophysiological monitoring method that records the electrical activity of the brain using electrodes placed along the scalp to measure voltage fluctuations resulting from ionic current in the neurons of the brain [62]. The EEG signal is the most important signal in the classification of sleep stages [63].

Different sleep stages are characterized by different brain activities that can be detected by EEG recordings. The EEG patterns of the different sleep stages are shown in Figure 4. Stage 1 is the transition stage between wakefulness and sleep. It usually lasts between 1 and 5 min. This stage

consists of a low-voltage EEG pattern with well-defined alpha (Figure 5(a)) and theta (Figure 5(b)) activity, occasional peaks in vertex activity, and slow eye movements. This stage, which represents on average 4% to 5% of total sleep, is free of spindles (Figure 5(d)) and K-complexes (Figure 5(e)). Stage 2 is the baseline of sleep and is characterized by the occurrence of sleep spindles and K-complexes and a relatively low-voltage, mixed-frequency EEG background noise. In addition, high-voltage delta waves can account for up to 20% of stage 2 epochs. Stage 3 is a period in which at least 20% and no more than 50% of sleep consists of EEG signals with a frequency of 2 Hz or less and an amplitude greater than 75 μV (delta waves; Figure 5(c)). Stage 4 is quite similar to stage 3, except that delta waves cover 50% or more of the recording. Stage 4 generally accounts 12%-15% of total sleep time.

Stages 3 and 4 together are also called deep sleep or slow wave sleep (SWS), and it is the most restorative part of sleep. REM is the sleep stage in which dreams occur and makes up 20%-25% of a normal night's sleep. The incidence of rapid eye movements under closed eyelids, motor atonia, and low-voltage EEG patterns are well known. During REM sleep, brain activity is reversed from stage 4 to a pattern similar to stage 1. The characteristics of each sleep stage are summarized in Table 3. Although the EEG is accurate in determining sleep stages, the complexity and intrusiveness of the user make it difficult to monitor sleep on a large scale, over the long term and in the home.

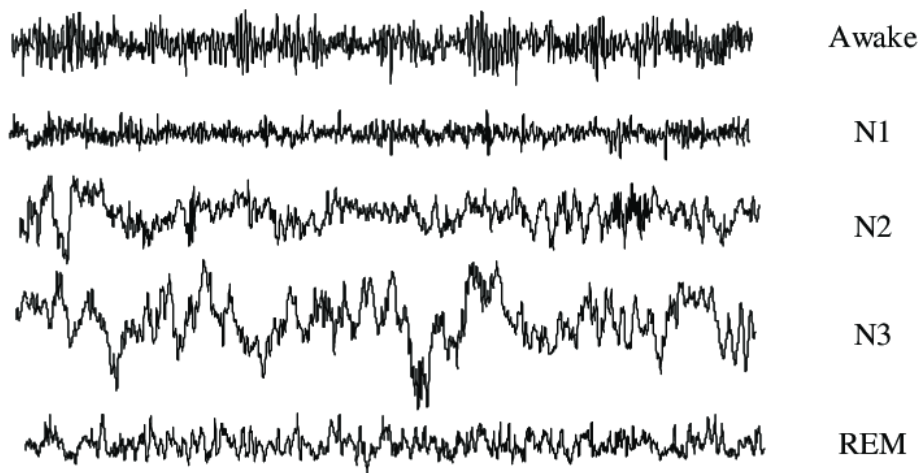

Figure 4. Typical EEG pattern for different stages of sleep [64].

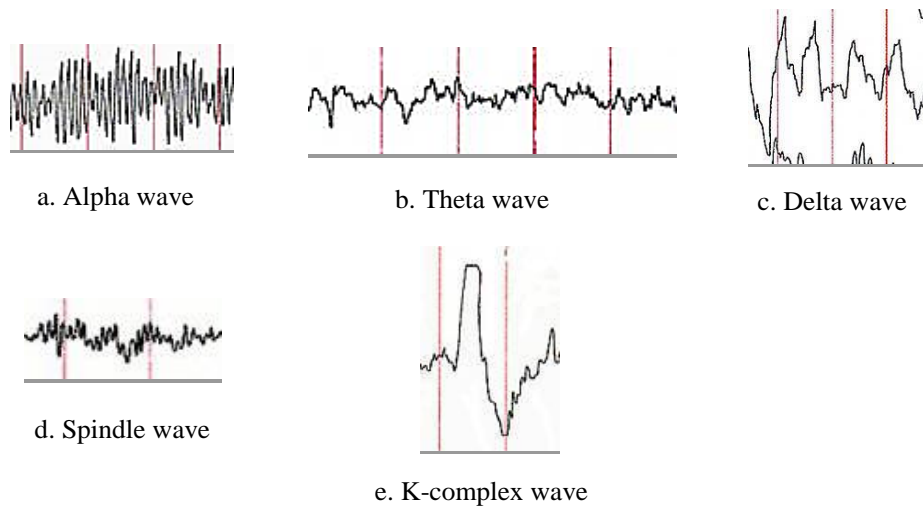

Figure 5. Typical EEG wave types.

Table 3. Characteristics of each stage of sleep.

Sleep stages	Proportion of sleep (%)	EEG frequency (Hz)	EEG amplitude (mv)	EEG percentage (one screen)
Awake	<5	15 to 50	<50	$\alpha > 50\%$
N1	2 - 5	4 - 8	50 - 100	Theta wave >50% or alpha wave <50%
N2	45 - 55	4 - 15	50 - 150	Delta wave < 20%; K-complex > 1.7%
N3	3 - 8	2 to 4	100 - 150	Delta wave 20% to 50%
N4	10 - 15	0.5 - 2	100 - 200	Delta wave >50%
REM	20 - 25	15 - 30	<50	EEG with mixed wave

4.1.3 ECG

Electrocardiography (ECG) is the process of recording the electrical activity of the heart over a period of time using electrodes placed on the skin. These electrodes detect tiny electrical changes on the skin that result from the electrophysiological pattern of depolarization and repolarization of the heart muscle with each heartbeat. In a conventional 12-lead ECG, 10 electrodes are placed on the patient's limbs and on the surface of the chest. The correlation behavior in the heartbeat rate differs significantly for light sleep, deep sleep, and REM sleep. During deep sleep, the heart rate is reduced, whereas a relative increase is observed in REM sleep [65]. In addition, spontaneous movements during sleep are preceded by an increase in heart rate [66]. These observations indicate a functional

link between cardiac activities and sleep stages. As with PSG and EEG, the complexity, high equipment, and expertise requirements of the standard ECG are barriers to its use as a large-scale, long-term, home sleep monitoring method.

4.2 Wireless body area network (WBAN)

4.2.1 Introduction

The wireless body area network (WBAN) is a wireless sensor network that aims to monitor the user's vital signs and physiological information by deploying sensors on or next to the human body. Parameters acquired from the WBAN can include brain waves, heart rate, body movements, skin temperature, blood oxygen saturation level, sound, etc. or environmental conditions such as temperature, brightness, noise level and humidity. Thanks to advances in sensor and communication technology, WBAN enables the exchange of information or commands over short distances between sensor components. Moreover, remote data transmission or control between the sensor components and the database or control center is also available based on WBAN. Features such as these make the WBAN a very suitable tool for performing continuous monitoring tasks without requiring too much manual intervention, thus meeting the requirements of sleep monitoring. As a result, many sleep monitoring systems have been developed by researchers and technicians based on the WBAN.

WBAN technology is highly valued in the fields of medical sciences and human health care [67]. In the health care field, WBAN has established itself as a leading technology capable of providing real-time patient health monitoring in hospitals, asylums, and even at home [68]. WBAN allows the removal of cables and the relocation of instrumentation and intelligence to the sensor nodes themselves, which is useful for establishing a nonintrusive, portable, continuous home sleep monitoring system [59]. Currently, the WBAN-based sleep monitoring system has attracted increasing attention from researchers around the world [69][70][71]. Like the evolution of the WBAN, the trends in sleep monitoring system are miniaturization, intelligence, and long-term monitoring capability. In this section, we have selected some representative works on WBAN-based sleep monitoring systems over the last few years, which we briefly present from a hardware and software point of view.

4.2.2 Hardware implementation

A WBAN-based sleep monitoring system is a sensor network application in which the sensor is an essential piece of hardware. The choice of sensor determines the type of body parameters that will be acquired, and the position of the sensors directly influences the efficiency, quality of data acquisition,

and user acceptance. For these reasons, we list the type and position of sensors used in several works, specify the possible description of sleep phases, and briefly analyze the advantages and drawbacks of each type of sensor, as presented in Appendix I. Table 4 lists the sensors used in each study.

Table 4. Choice of sensor for different sleep monitoring works.

Source	Accelerometer	Pressure sensor	Temperature sensor	Thermopile sensor (Infrared)	Microphone	ECG sensor	Pulse sensor
Kalkbrenner et al [74]	✓ ^a	— ^b	—	—	✓	—	—
Guettari et al [42]	—	—	—	✓	—	—	—
Seba et al [97]	✓	—	✓	✓	—	—	—
Velicu et al [72]	✓	—	—	—	—	✓	—
Suzuki et al [93]	✓	—	✓	—	—	✓	✓
Suzuki et al [80]	✓	—	—	—	—	—	✓
Saad et al [114]	✓	—	✓	—	—	—	✓
Sadek et al [95]	—	✓	—	—	—	—	—
Sadek et al [98]	—	✓	—	—	—	—	—
Lee et al [99]	✓	—	—	—	—	✓	—
Chan et al [94]	✓	—	—	—	—	✓	—
Samy et al [100]	—	✓	—	—	—	—	—

^aTick mark: the sensor is included

^bEm dash: the sensor is not included

As shown in Appendix I, the accelerometer is the most commonly used sensor in these works, usually placed on the wrist or chest or close to both positions. The microphone has been adopted only once in these works. However, the microphone is a sensor widely used in the monitoring of sleep apnea [67][101][102]. As a sound recording sensor, the microphone is useful for detecting snoring or even abnormal breathing [103], which are also important physiological parameters related to the sleep state. Both the ECG sensor and the pulse sensor are used for heart rate monitoring, but due to different detection principles, their positions are different. Appendix I shows that in most cases, the ECG sensor is placed close to the chest, while the pulse sensor is placed close to the wrist. Thus, for user acceptance, the pulse sensor is better than the ECG sensor.

Both the accelerometer and the thermopile sensor can be used for motion detection, but they have their own advantages. In terms of user acceptance, the accelerometer should generally be attached to the user's body, but the thermopile sensor is a non-contact sensor, so the thermopile sensor is

preferable. However, with regard to measurement accuracy, thermopile sensors are easily disturbed by the user's coatings, such as duvets, which affect the measurements. In addition, thermopile sensors can only monitor effectively in a limited and fixed area. It is difficult for thermopile sensors to specifically measure the movement of certain parts of the body, such as measuring only leg movement to detect periodic leg movements during sleep. As a result, the accelerometer outperforms the thermopile sensor. In short, the type of sensor to be chosen depends on the application scenario and specific requirements.

4.2.3 Software and algorithm processing

Software or algorithms are used to process the data collected by the hardware. Table 5 presents the algorithms, software, and system results illustrated in several books or articles.

Table 5. Implementation of software or algorithm in various works.

Source	Involved algorithms or software	Outputs
Kalkbrenner et al [77]	<ol style="list-style-type: none"> 1. An FIR bandpass filter with boundaries between 200 and 2000 Hz was used on the initial raw tracheal body sound signal acquired by microphone to obtain a pure breathing sound signal 2. A bandpass filter with the boundaries between 5 and 30 Hz was applied on the initial raw tracheal body sound signal acquired by microphone to suppress breathing and most of the artifacts to get heart beat sound 3. A LD classifier was used on cardiorespiratory features and movement features for automated sleep staging 	<ol style="list-style-type: none"> 1. Sleep and wake classification 2. Wake, REM, and NREM classification 3. Wake, REM, light sleep, and deep sleep classification
Sadek et al [95]	<ol style="list-style-type: none"> 1. Wavelet decomposition was used on microbend fiber optic sensor data to achieve the measuring of heart rate 2. Third-order polynomial fit and Savitzky-Golay smoothing was used on microbend fiber optic sensor data to achieve the measuring of respiratory rate 3. Adaptive thresholding method was used on SD of the respiratory signal for apnea or nonapnea classification 4. Chebyshev type-I bandpass filter was used on microbend fiber optic sensor data to extract BCG and respiratory signals 5. The MODWT with the multiresolution analysis was used on microbend fiber optic sensor data to estimate heart rate 	Heart rate, respiratory, and apnea
Guettari et al [42]	<ol style="list-style-type: none"> 1. SAX method was used on thermal sensor data for segmentation processing of the thermal signal 2. SOM algorithm—Kohonen maps is used on features of thermal signal segmentation level, thermal signal segmentation duration and the variance of each thermal signal segmentation for achieving classification 	Classification of signal segments as 3 phases of sleep: <ol style="list-style-type: none"> 1. Deep and paradoxical sleep (<i>REM</i>, N3) 2. Agitated and light sleep (N1, N2) 3. Awake phase (<i>Wake</i>)
Seba et al [97]	K-means algorithm was used on IButton skin temperature sensor data to achieve data clustering and classification	Classification of the activities into 3 classes: <i>awakening</i> , <i>calm sleep</i> , and <i>agitated sleep</i>
Saad et al [90]	This sleep monitoring system involves Arduino IDE software and Visual Studio 2015. <ol style="list-style-type: none"> 1. Arduino IDE is programmed that consist of sensor algorithms to enable those 	The relationship between the room ambience and quality of

	<p>sensors and to read the value that has been captured from room ambience and body condition.</p> <ol style="list-style-type: none"> 2. A window application was programmed by Visual Studio to display the value of those parameters. 	sleep
Sadek et al [96]	<ol style="list-style-type: none"> 1. Multiresolution analysis of the maximal overlap discrete wavelet transform was used on piezoelectric sensor data to compute heart rate. 2. Bandpass Butterworth filter is used on microbend sensor data to retrieve BCG signal. 	Heart rate of the person sitting in the massage chair
Velicu et al [72]	Kushida algorithm-derived equation was used on accelerometer data as the discriminator for wake or sleep, wake or REM, and light or deep by applying 3 different thresholds.	Discrimination for wake or sleep, wake or REM, and light or deep
Sadek et al [98]	<ol style="list-style-type: none"> 1. For comparison, 5 classifiers are employed, that is, RF, SVM, multilayer, feedforward NN, LDA, and DT 2. Butterworth bandpass filter with frequency limits of 1 Hz and 12 Hz was used on microbend fiber optic sensor data to extract BCG component 3. MATLAB based software was developed as a data labeling tool 	Classification of informative and noninformative signal for further heart rate detection work
Kalkbrenner et al [74]	<ol style="list-style-type: none"> 1. The developed software for visualizing and storing received data 2. Heart sound was extracted by applying a bandpass filter ranging from 15 Hz up to 80 Hz on microphone data 3. Breath sound was extracted by applying a bandpass filter ranging from 100 Hz up to 1.5 kHz on microphone data 4. Stable results of accelerometer are provided by using the Madgwick-Filter 	Heartbeats, breathing, snoring, sleeping positions, and movements of the volunteer
Sadek et al [104]	<ol style="list-style-type: none"> 1. The BCG signal is decomposed using CEEMDAN (complete ensemble empirical mode decomposition with adaptive noise) 2. Sensor data fusion method: time domain average 3. The BCG signal is extracted using a Butterworth high-pass filter (fifth-order with a cutoff frequency of 0.2 Hz) followed by a Butterworth low-pass filter (10th order with a cutoff frequency of 30 Hz) on microbend fiber optic sensor data 	Heart rate
Suzuki et al [93]	<ol style="list-style-type: none"> 1. Silmee framework provides basic functionality of Silmee system by locating Silmee sensor node, smartphone (or tablet or wearable terminal) and cloud server 2. Silmee firmware provides vital signal processing capabilities such as noise reduction, important information extraction, or data compression 3. Silmee API: This API provides basic information to realize wide-variety of smart healthcare MWs and apps 4. Silmee MWs are located in smartphone (or tablet or wearable terminal) or in health care cloud server. The MWs provide less medical expert API than Silmee API. For example, determination of REM and non-REM sleep, which is a popular term, is one of Silmee MW API, which is calculated by R-R intervals information included in the Silmee API 	ECG wave, pulse wave, skin temperature and body movements were measured by the set and send to a smartphone using a Bluetooth wireless connection
Suzuki et al [80]	<ol style="list-style-type: none"> 1. The Cole algorithm for wake and sleep identification from the amount of activity data 2. Fast Fourier transformation (FFT) is executed for the even-interval pulse-to-pulse intervals (PPIs) to get the frequency spectrum 3. The k-means clustering method is adopted to classify sleep stages 	Wristwatch-shaped physiological sensor that monitors user's wrist motion and pulse wave interval
Lee et al [99]	<ol style="list-style-type: none"> 1. To capture the respiratory signal, first-order derivation is used to compensate for the drifting phenomenon of pressure sensor 2. A low-pass filter is applied to eliminate short-term fluctuations in respiration 	Classification of sleep stages: <ol style="list-style-type: none"> 1. Wake 2. NREM

	<p>signals</p> <ol style="list-style-type: none"> Sum all the pixels in the lower half of the pressure image and mark a leg movement when a significant drop or increase in pressure is detected A simple thresholding technique for movement reporting 	<ol style="list-style-type: none"> REM
Beattie et al [105]	The Scikit library used to explore different types of classifiers: LD classifiers, quadratic discriminant classifiers, RF, and SVM approaches, and the LD classifier achieved the best performance	<p>Classification of sleep stages:</p> <ol style="list-style-type: none"> Wake Light (N1 or N2) sleep Deep (N3) sleep REM
Teruaki et al [119]	<ol style="list-style-type: none"> To convert the video image to grayscale images to calculate the inter-frame difference. To calculate the difference in luminance between two frames at each pixel. If the difference in the luminance value at a pixel is greater than a set threshold, the pixel is converted to white (luminance value is 255) or black otherwise (luminance value is 0) for binarization. Noise in the inter-frame difference is reduced by expansion and erosion. The number of white pixels is counted, and the summed value is regarded as a measure of the amount of body movement. Four sleep stages classification using support the vector machine (SVM) classifier. 	<p>Classification of sleep stages:</p> <ol style="list-style-type: none"> Wake Light (N1 or N2) sleep Deep (N3) sleep REM
Kim et al [120]	<ol style="list-style-type: none"> To calculate the sum, mean, standard deviation (STD) and maximum values of the movement data as a feature for the sleep quality classification. Five classifiers: decision tree, Naïve Bayes, multilayer feed-forward neural network, AdaBoost, and random forest were used for the sleep quality classification. 	<p>Classification of sleep quality:</p> <ol style="list-style-type: none"> good moderate poor
Chang et al [121]	<ol style="list-style-type: none"> To calculate the root mean square, the ratio between the low-band and high-band energies and the variance of the acoustic signal recorded by the smartphone's built-in microphone as a feature for detecting snoring, coughing and body movements. Decision tree classifier to classify different sleep-related events. 	<p>Classification of sleep-related events:</p> <ol style="list-style-type: none"> Snore Cough Body movement

Data or signal processing algorithms typically include spectral analysis, wavelet transformation, Empirical Mode Decomposition (EMD), and a variety of filters. Many sleep-related physiological signals, such as the EEG and ECG, are non-stationary. Wavelet analysis is very useful for processing non-stationary signals and has been adopted by many researchers specialized in sleep monitoring. EMD, proposed by Huang et al [106], is generally used to extract breathing and heartbeat signals from the measured data. Unlike wavelet decomposition methods, this method is based on data and does not require the prior definition of a mother wavelet. With this technique, any complicated signal can be decomposed into a defined number of high and low frequency components, called intrinsic mode functions. This technique is suitable for the analysis of non-linear and non-stationary biosignals [107] and allows the extraction of local temporal structures such as heartbeats superimposed on respiration signals [108]. In sleep monitoring, several types of biosignals of

different frequencies are acquired simultaneously. Therefore, filters are effective and simple tools for signal discrimination that are widely adopted in this field.

The classification algorithm is usually used for the classification of sleep stages. Sleep stage classification is an important and common output of the sleep monitoring system. Although sleep stages include stages 1, 2, 3, and 4 and the stage REM according to the AASM [22], most research classifies sleep stages more simply as a wake, light sleep (stages 1 and 2), deep sleep (stages 3 and 4), REM [105] or wake, NREM (stages 1, 2, 3, and 4), REM [99], or some other similar way. This simplification of sleep stages implies a balance between the difficulty of the task and the application requirements. Commonly used classifiers include Random Forest (RF), Support Vector Machine (SVM), Multilayer, Feedforward Neural Network (NN), Linear Discriminant Analysis (LDA), Decision Tree (DT), and Bayes. Some papers compare the performance of several classifiers in their work to find the best [98][105].

4.2.4 Research prototypes

4.2.4.1 Non-contact methods

Seba et al [97] discussed the development of a new approach to sleep analysis. This system, based on temperature monitoring (patient and ambient), aims to be integrated into the telemedicine platform developed in the framework of the Smart-EEG project by the SYEL—SYstèmes ELelectroniques team. The proposed method is based on the thermal signature to classify the activity into 3 classes: awakening, calm sleep, and agitated sleep by k-means clustering. A thermopile sensor (TMP007) was placed above the bed at a distance close to 2 m to measure the upper Bed+Patient temperature. A thermal camera giving images in medical format but also information on the target temperature according to a spatial distribution is used to label the different events related to changes in the patient's posture in the bed by visual analysis by an expert. An inertial unit is used to obtain the wrist acceleration along 3 axes to compare the responses of the thermopile sensor. The system measured wrist, distal and proximal skin temperatures using IButtons [109], giving a numerical example of classification of sleep based on thermal data. The day/night alternation corresponds, on the one hand, to the alternation between wakefulness and sleep and, on the other hand, to the alternation between high and low temperatures. During sleep, the core body temperature decreases, while during the day it increases. Skin temperature, unlike the core body temperature, increases during sleep and decreases after waking. The work of [110] examined a possible mechanic sleep monitoring system linking rhythms in sleep and core body and skin temperature, focusing on the causal effects of core

and skin temperature changes on sleep regulation. Several studies refer to the links between core body or skin temperature and sleep [109][111].

Guettari et al [42] presented the design and first evaluation of a new monitoring system based on contactless sensors to estimate sleep quality. A passive thermopile sensor mounted on the wall produces thermal signals to detect human presence in the bed and then to estimate sleep quality. The Symbolic Aggregate Approximation (SAX) method has been implemented [112], which uses Gaussian window in the processing of the thermal signal segmentation. Each segment is generated by the SAX method based on a segmentation of the mid variance and then identifying its sleep phase. The system extracted 3 features: the duration of the thermal data segment, the variance of the thermal segment of each segment, and the level of each segment. The Kohonen self-organized map (SOM) [113] was used to classify the signal segments into 3 sleep phases: deep or paradoxal sleep (R, N3), agitated or light sleep (N1, N2), and awake phase (W). It synchronized the thermal signal with the sleep stage labels according to the physiological parameters measured by the PSG, with a hypnogram being established manually by the doctors. This study involved 13 patients, 11 people for the learning of the SOM model, and 2 other patients for the evaluation of the learned SOM model. In total, 87% (40/46) of the evaluation results showed good classifications.

Gu et al [45] presented Sleep Hunter, a mobile service that detects the transition between sleep stages for monitoring sleep quality and intelligent wakefulness. The smartphone was placed next to the participant's pillow. Using sensors built into smartphones, Sleep Hunter integrates body movements, acoustic events, environmental lighting conditions, sleep duration, and personal factors using a statistical model: the linear-chain conditional random field (CRF) [114] for sleep stage detection. He argued that, compared to the Hidden Markov Model [115], CRFs are more relevant for sequences that have long interdependencies and may therefore perform better in this application. Based on the duration of each sleep stage, Sleep Hunter also provides a report on sleep quality and a smart call service for users. In this work [45], the commercial product Zeo [116] was adopted as the reference device. A study [117] indicated that the quality of sleep is actually determined by the distribution of the different stages of sleep rather than the length of sleep during the night. This work distinguished the sleep stages between wakefulness, light sleep, deep sleep, and REM. The sleep quality score is then calculated according to the duration of each sleep stage. The detection accuracy of the Sleep Hunter proposed in this work [45] was 64.55%.

Krishna et al [118] proposed SleepSensei, an automated sleep quality monitor that estimates the sleep duration for the user. It uses (1) the built-in webcam and microphone of a personal computer

connected to a power source, and custom software to collect environmental features, and (2) the accelerometer sensor of a smartphone to detect body movements. Smartphones are placed close to the user (next to the pillow). In this system, the user can be in 1 of 2 sleep states: deep sleep or light sleep. The user's sleep state (sound or light) is determined solely on the basis of the variance of the user's body movements during sleep. Environmental features such as light intensity, ambient noise, temperature, and humidity have been entered by using custom software.

Temperature, ambient sound (noise and music), and light conditions have been proven to be strong indicators of the user's environment that clearly affect sleep [122]. The system proposed a regression model consisting of linear regression and SVM regression. The regression model estimates the share of each time slot (30-min window) that contributes to the completion of a user's sleep quota (the total duration of sleep a user needs to obtain satisfactory sleep). The ground truth of this system comes from the data provided by users on the quality of sleep by answering the question: was the sleep fulfilling? It uses SVM and naive Bayes models as classifiers. By comparing the results of each classifier with 2 and 4 times cross-validation, the SVM model with 2 times cross-validation has the best results and has an average accuracy of 79.84%.

Teruaki et al [119] developed a sleep monitoring system based on an infrared web camera (DC-NCR300U, Hanwha Q CELLS Japan co. ltd., Japan) placed on the bedroom wall. They extracted data on body movements by processing the recorded video data. Five parameters were then calculated from the extracted body movement data. Finally, four sleep stages (Wake, Light, Deep and REM) were estimated by applying these five parameters to a SVM classifier. A total of 23 nights of 6 subjects were used for the performance tests. The overall estimation accuracy was $70.3 \pm 11.3\%$ with the highest accuracy being that of Deep ($82.8 \pm 4.7\%$) and the lowest being that of Light ($53.0 \pm 4.0\%$) and $68.0 \pm 6.8\%$ that of REM compared to the PSG results.

Kim et al [120] propose an unobtrusive sensing environment including a high-sensitive accelerometer on a bed and passive infrared (PIR) motion sensors in every room, for monitoring the elderly's sleep-wake conditions, to assess their sleep quality. The PIRs are installed on the wall and just below the ceiling of the room to detect the presence of a person in the room. The accelerometer (BMA250E) was placed under the mattress to detect the presence of a person sleeping on a bed and the detected signal was collected for storage and analysis to determine the quality of sleep. Four parameters including the sum, mean, standard deviation (STD) and maximum values of the movement data collected by the accelerometer under the mattress, were calculated as features of the sleep quality classification. Five classifiers: decision tree C4.5, Naïve Bayes, multilayer feed-forward

neural network, AdaBoost, and random forest were used for the sleep quality classification (including three classifications level: good, moderate and poor). The Pittsburgh Sleep Quality Index (PSQI) was adopted as the ground truth. 235 nights of 4 elderly people were included in the performance tests. The classification accuracy of five classifiers decision tree C4.5, Naïve Bayes, multilayer feed-forward neural network, AdaBoost, and random forest is 90.87%, 85.00%, 94.17%, 92.5% and 92.43 respectively.

Chang et al [121] present a system called iSleep to monitor the quality of people's sleep using a standard smartphone. iSleep uses the smartphone's built-in microphone to detect events that are closely related to sleep quality, and derives quantitative measures of sleep quality using actigraphy scoring criteria and the Pittsburgh Sleep Quality Index (PSQI). They extracted three features: the root mean square, the ratio between low and high band energies and the variance of the the recorded acoustic signal to detect snoring, coughing, and movement events during sleep through a decision tree classifier. They evaluated iSleep in a long-term experiment involving seven participants and a total 51 nights of sleep. The experimental results show that iSleep achieves an accuracy of more than 90% for the classification of sleep events in different contexts.

4.2.4.2. Contact methods

Distributed Sensor System on the Body

Velicu et al [72] proposed a system based on an accelerometer and an ECG sensor for the classification of sleep phases (wakefulness, light sleep, deep sleep, and REM). The accelerometer was embedded in a wristband, but the position of the ECG sensor was not mentioned. It described the classification logic: (1) the body movements become less intense and less frequent when we enter the deeper phases of sleep and (2) the HR becomes more stable as the sleep deepens. The equation derived from the Kushida algorithm [73] was adopted in this system as a discriminator between wake and sleep using accelerometer data collected every minute, with a 9-min sliding time window, showing 69% agreement with the EEG sensor result. This work shows part of the classification results for an experiment lasting 3 hour and 43 min. However, the results have not been validated against the PSG or any other reliable standard.

Kalkbrenner et al [74] presented the first step in the development of a sleep monitoring system. It includes the capabilities to capture heartbeats, breathing, snoring, sleeping positions, and movements of 2 volunteers. In this system, a microphone was set up at the suprasternal notch to record breathing sounds and heart sounds. The heart signal is extracted by applying a band-pass filter from 15 Hz to

80 Hz. Nakano [75] and Yadollahi [76] have shown that placing a stethoscope such as a microphone in the suprasternal notch at night can detect sleep apnea. At the same time, an MPU6000 inertial measurement unit embedded in an abdominal belt worn by the patient determines sleep position and movements. The data is transmitted wirelessly to the laptop via Bluetooth and processed, visualized, and stored using specially developed software. The validation of the proposed system by comparison with the gold standard was published in [77]. A total of 60 adult subjects were diagnosed at night, and PSG screening was included for validation of the proposed system. A total of 30 feature dimensions were extracted from the data on breath, heartbeat, and movement. A linear discriminant (LD) classifier was used for automated sleep staging. The classifier achieved an accuracy of 86.9% and a kappa of 0.69 for the sleep or wake classification, an accuracy of 76.3% and a kappa of 0.42 for the Wake or REM or NREM classification, and an accuracy of 56.5% and a kappa of 0.36 for the wake or REM or light sleep or deep sleep classification.

Lee et al [78] have proposed smart patches and wearable bands (W-band) to record biosignals during sleep. The system consists of 15 smart patches attached to the user's face to monitor multiple biosignals (EEG, ECG, EMG and EOG). A total of 14 biosignal sensor (SN) patches to monitor biosignals, a network controller (NC) patch placed behind the ear to manage the whole system and used as a reference electrode for ECG, EEG and EOG signals. All electrodes are implemented on a multilayered fabric patch based on the Planar Fashionable Circuit Board technology. The biosignals recorded by the SN patches are collected in the NC patch with an internal 20 kb SRAM via the W-band. When the memory is full, the recorded data is transmitted to an external device via an inductively coupled interface. The program displaying the data runs on an external PC so that the user can check the monitoring result after waking up. The performance of biosignal recording by this system has not been compared to a gold standard.

Stand-Alone System with Several Sensors

Shambroom et al [79] evaluated a wireless system for the automatic collection and scoring of human sleep. This system uses dry silver-coated fabric sensors in the headband to collect electrophysiological signals from the forehead, which include contributions from the EEG and eye and forehead muscle movements. The resulting signal is transmitted to a base station using an ultra-low-power wireless protocol at 2.4 GHz. The system was compared with the PSG data scored by 2 technicians using R&K criteria. A reduced set of sleep stage classifications was adopted, including awake, REM, light sleep (combined N1 and N2 stages), and deep sleep (combined N3 and N4 stages) [21]. A total of 26 healthy adults were subjected to simultaneous sleep measurements using this

system and the PSG. Agreement was 62% and 56%, respectively, for PSG1 (recording of PSG noted by technician 1) and PSG2 (recording of PSG noted by technician 2). The mean agreement (SD) on the complete night sleep stage for the 26 subjects was 75.9% (7.0%) for this system compared to PSG1 (PSG recording noted by technician 1), 74.7% (8.5%) for this system compared to PSG2 (PSG recording noted by technician 2), and 81.2% (7.4%) for this system compared to PSGC (PSG recording noted consistently by 2 technicians).

Suzuki et al [80] described a wristwatch-shaped wearable sleep monitoring system for home use. The sensor incorporates a photoelectric pulse wave sensor and a 3-axis accelerometer to measure pulse waves and accelerations at the user's wrist and stores the calculated pulse intervals (PPIs) and amount of activity in a flash memory (4 MB). It uses the Cole's algorithm to identify waking or sleeping from the amount of activity data [81]. The system compared the estimation result with the PSG results. A Fast Fourier transform (FFT) is performed to obtain the heart rate spectrum. In the frequency domain, the integral value of the power from 0.04 Hz to 0.15 Hz is called LF (low frequency), which indicates both sympathetic and parasympathetic nervous activities. The integral value of the power from 0.15 Hz to 0.4 Hz is called HF (high frequency), which indicates parasympathetic nervous activity. The balance between sympathetic and parasympathetic nervous activity is related to the stages of sleep. According to the study by Baharav et al [82], there is a decrease in LF during sleep, with minimal values during non-REM slow wave sleep, i.e. deep sleep, and high levels similar to those of wakefulness during REM.

The HF increased with the onset of sleep, reaching maximal values during slow wave sleep, and behaved as a mirror image of LF, as shown in Figure 6. The correlation between HF, LF of PPI, and sleep stages is summarized in Table 6.

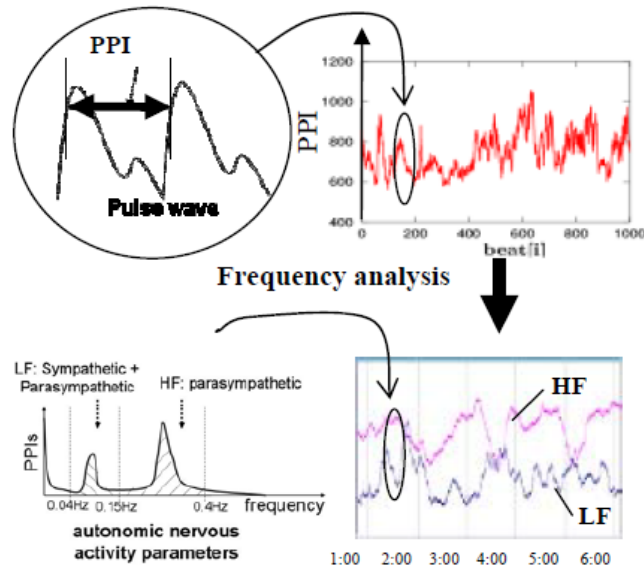

Figure 6. Illustration of HF and LF from PPI [93].

Table 6. Correlation between high and low frequency PPIs (pulse-to-pulse intervals) and sleep stages.

Frequency band	Sleep onset	Slow wave sleep	Wakefulness
HF	Increase	Maximum	Low level
LF	Decrease	Minimum	High level

The sympathetic predominance that characterizes wakefulness decreases during non-REM sleep, is minimal during slow wave sleep and approaches average levels of wakefulness during REM sleep. Autonomic balance shifts to parasympathetic predominance during slow wave sleep. To classify sleep stages from the LF and HF data sets, the k-means clustering method is adopted. It defines the coincidence ratio as a moving average sleep stage correlation coefficient (20-min window) between the stages estimated by this method and those estimated by the PSG. A mean coincidence ratio of 0.735 (SD 0.052) was obtained for the classification of SWS, REM, non-REM, and wake stages.

Beattie et al [105] estimated sleep stages using a wrist-worn device that measured movements using a 3D accelerometer and an optical pulse photoplethysmograph, which provided data on movement, breathing, and heart rate variability. Night-time recordings were obtained from 60 adult participants wearing these devices on their left and right wrists, simultaneously with a type III home sleep testing device (Embletta MPR) that included EEG channels for sleep stages. The reference Embletta recordings were scored for sleep stages using the AASM guidelines [83], which indicate sleep stages as awake, light (N1 or N2), deep (N3), and REM over a 30-second epoch period. Motion-based

features include the number of activities over 30 seconds, the magnitude of rotation (using the 3D accelerometer to combine the maximum–minimum of each axis), the time from the last significant movement and the time until the next significant movement. They extracted heart rate features such as HF power (0.15-0.4 Hz), LF power (0.04-0.15 Hz), very low frequency (VLF) power (0.01-0.04 Hz), root mean square of the successive differences, pNN50 (the proportion of the number of pairs of successive RR intervals -the interval between R waves of the ECG, i.e. the time between heart beats- that differ by more than 50 ms divided by the total number of RR intervals), delta RR (intervals between beats) and the average heart rate.

The spectral features of the estimated breathing rate on a 1 s basis such as HF power (0.15-0.4 Hz), LF power (0.04-0.15 Hz) and VLF power (0.015-0.04 Hz) were formed. The system used the Scikit library to explore different types of classifiers: LD classifiers, quadratic discriminant classifiers, RF, and SVM approaches. The LD mode seems to work a bit better than the others, so it was chosen as the final model. Based on a single validation, the overall accuracy per epoch of the automated algorithm was 69%, with a Cohen kappa of 0.52 (SD 0.14).

Only One Sensor Attached to a Single Body Location

Tataraidze et al [84] presented an algorithm for the detection of wakefulness, REM, and non-REM sleep based on a set of 33 features extracted from the respiratory inductive plethysmography signal captured by the PSG thoracic belt. The features extracted include logarithm of power in different frequency ranges, time and frequency domain features, motion, breathing, and volume-based features. A bagging classifier was used in the experiments and a heuristic algorithm was applied to increase the performance of the classification. Compared with the PSG gold standard, an accuracy of 80.38 (SD 8.32%) and a Cohen kappa of 0.65 (SD 0.13) were obtained with the classifier.

4.2.5 Commercial products

Given the various shortcomings of PSG, such as its invasiveness, high cost, and one-night monitoring, the industry has shown great enthusiasm for the development of commercial sleep monitoring products with the advantages of being portable, noninvasive, and suitable for long-term monitoring. Commercial products used for home sleep monitoring are currently available for direct sale on the market. Some of the most popular and representative products are briefly introduced below.

Zeo [116] is a headband based on a true lightweight EEG brainwave pod monitor. It can provide a classification of sleep stages into awake, light (stages 1 and 2 combined), deep (stages 3 and 4

combined), and REM sleep. The Companion for Zeo smartphone app has been developed for data collection. A validation study has been published [79]. Compared to the PSG, the epoch-to-epoch concordance of light, deep, and REM sleep is greater than 74%.

Up (Jawbone) [85] is a soft rubber wristband. In terms of sleep monitoring, it provides total sleep duration, time to fall asleep, and the number of night-time awakenings. It also interacts with smartphone applications. To date, no validation studies have been carried out.

Fitbit [86] is also a wristband product. Its sleep monitoring algorithm classifies night sleep into awake, light sleep, deep sleep, and REM based on wrist movements and heart rate data. It also provides total sleep duration, sleep starting time and sleep end time. The publication [83] evaluates the performance of the Fitbit against the PSG. It shows a sensitivity of 0.96 (sleep detection accuracy), a specificity of 0.61 (wakefulness detection accuracy), an accuracy of 0.81 for the detection of N1+N2 sleep (light sleep), an accuracy of 0.49 for the detection of N3 sleep (deep sleep), and an accuracy of 0.74 for the detection of REM sleep.

RestOn [87] is a thin belt. It uses a single click of the magnetic cover to fix the device on the bedsheet; the position corresponds to the user's chest. RestOn can measure heart rate and respiratory rate in real time. The 2-foot-long medical-grade sensors are embedded into a thin belt less than 2 mm long. The device can provide sleep time, actual sleep time and sleep stages including awake, light, medium, and deep sleep. Its smart alarm can wake the user during the lightest sleep time.

The Sleep Dot [88] measures sleep cycles and body movements by simply attaching it to the upper corner of the pillow. It can play music to help the user fall asleep. Soothing sounds and music are adopted as alarm tones to wake the user more naturally during the lightest sleep. This product works with a smartphone application and generates a sleep report that can be shared with family and friends.

Withings Aura [89] is a bedside device with a white fabric sleep sensor placed under the mattress, aligned in position with the user's chest. It is recommended that the 11-inch high bedside device be placed at least 1 m from the bed. The bedside device measures environmental parameters such as temperature, light, and noise. The white fabric sleep sensor indicates the sleep time, the number of awakenings during the night, the duration of light sleep or deep sleep or REM sleep, and the percentage of the sleep target achieved.

5 Conclusion

Sleep observation and analysis is a very important medical issue considering the possible consequences on people's behavior. Indeed, sleep is a very important biological function for humans and it strongly contributes to the quality of life. The analysis of sleep quality makes it possible to diagnose sleep disorders or even to explain them by linking them to external factors (diseases, stress, anxiety, depression, pathologies, etc.). It appears that sleep disorders are increasing sharply among the world's population. The scientific challenge of finding solutions that can be deployed on a large scale, automated and as reliable as the techniques used in the medical field is important and is attracting the interest of researchers and manufacturers.

So, the objective of this chapter was to recall the societal, medical but also technological stakes on the issue of sleep monitoring and analysis. It provides an overview of the current state and future prospects of research and development of sleep monitoring systems. The gold standard used is the PSG technique, which is an intrusive method that can only be used in a clinical setting. Several studies have focused on the development of methods and strategies for lighter and longitudinal monitoring. Sleep monitoring systems have been proposed but they raise questions about user acceptance of wearing these devices, socio-economic aspects, privacy and impact on society, but also about the performance of the proposed algorithmic processing. This chapter deals with these issues and the different solutions reported in the literature and available on the market.

The sleep monitoring system features a broad and heterogeneous range of devices, WSN standards and applications, and involves the efforts of many researchers, developers, and users. Due to its interdisciplinary nature, several applications related to sleep monitoring integrate biomedical engineering and medical informatics. Other knowledge in the fields of medicine, social sciences, psychology, economics, ethics, and law must be taken into account and integrated into the development and deployment of wearable healthcare systems. Most systems are still at the prototype stage and developers have not yet faced deployment issues. Information technology and electronics are mature fields and can provide viable, disposable, and affordable wearable systems.

In chapter 2, we will present our global hardware proposal for sleep monitoring with the deployed hardware and architecture.

Chapter 2. Hardware architecture proposal for sleep monitoring

1 Introduction

As mentioned in Chapter 1, sleep monitoring is mainly carried out in hospital sleep units and is based on international standards: PSG (Polysomnography) and EEG (Electroencephalography). However, PSG and EEG have many disadvantages. Indeed, they are very invasive and very complicated to implement and transport. In addition, they are very expensive and can only be found in hospitals and specialized units. However, with the rapid development of wireless sensor networks (WSNs) and BodyLAN technology, alternative wearable solutions for sleep monitoring have recently emerged. As we see in Chapter 1, these systems have a number of disadvantages such as unreliability, complexity and still high cost. Besides these systems do not allow to monitor all parameters as PSG and EEG and do not achieve the same level of performance and reliability. Finally, the existing professional systems do not allow remote monitoring at home, nor easy remote control by doctors. As a result, the patient has to visit the hospital periodically to see his doctor and make short sleep observation stays (1 or 2 nights at most), which most patients are reluctant to do.

In this chapter, we attempt to provide an alternative solution to these issues by proposing a complete SMS hardware architecture providing information that is as relevant as current standards and meets the requirements of doctors.

2 Overall SMS architecture

After discussions with researchers, technicians and doctors, we specified the requirements that the system should meet. Technically, it is mainly a matter of proposing and building a communicating portable system within a network architecture, which can include several people at home or in the hospital. This system must be fully configurable locally by the person concerned and also remotely by the doctor. In addition, the system must be able to feed monitoring data from each patient (at home or in hospital) to a server-based database to be viewed and analyzed by doctors on a suitable interface. Thus, the overall architecture of the proposed sleep monitoring system was specified as shown in Figure 7.



Figure 7. Overall architecture of the proposed sleep monitoring system.

The overview of the main functions/services of the system is divided into several sub-systems: The "Sensors", The "Master", the "Gateway", the Android application, the database and the website.

The sensors acquire sleep-related physiological data that will be sent to the master board via BLE (Bluetooth Low Energy) [123] when the user sends “data uploading” command to the master board through customized smartphone application “L.M.S”. After receiving the data from the sensors, the master board sends the data to the gateway via LoRaWAN (Long Range Wide Area Network, hereinafter referred to as LoRa) [124]. The gateway is responsible for sending the received data to the database via Internet, which is done through the WiFi network of patients [125]. Finally, doctors or users can easily check the sleep monitoring data through web pages that perform requests to the database. Users can use the customized smartphone application “L.S.M” (LAAS Sleep Monitoring) to send control commands to the system via BLE, thus conveniently performing operations such turning the system on and off or downloading data.

2.1 How the system works?

Notification is used for transferring measurement data from sensors at the end of the night; depending on the protocol, the client can request a notification for a particular feature from the server. The server then sends the value to the client when it becomes available. In our case, each sensor notifies the BLE client (Master) whenever there is data to be transmitted (every 12.5 ms). This is a huge advantage of this technology. It prevents the client from constantly probing (polling) the server, as this would require the server's radio circuit to be constantly operational, resulting in considerable energy optimization. The Master is the heart of our system. It simultaneously plays the two roles of BLE (BLE master for the sensors and BLE slave for the Android application “L.S.M”). It has the same operating modes as the sensors. The operation of the system can be represented by the following sequence diagram (Figure 8):

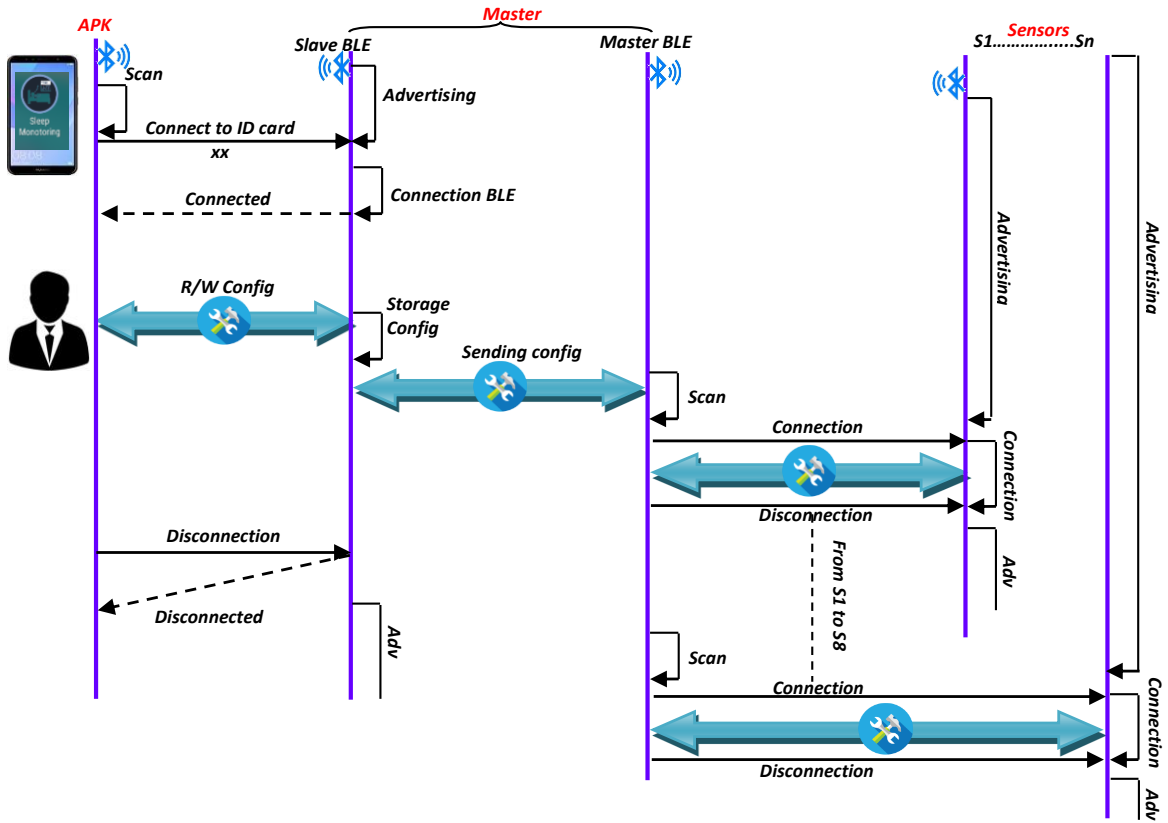

Figure 8. Sequence diagram for local configuration.

In the system development and testing phase, the physical shots of the components of the system are shown in the Figure 9.

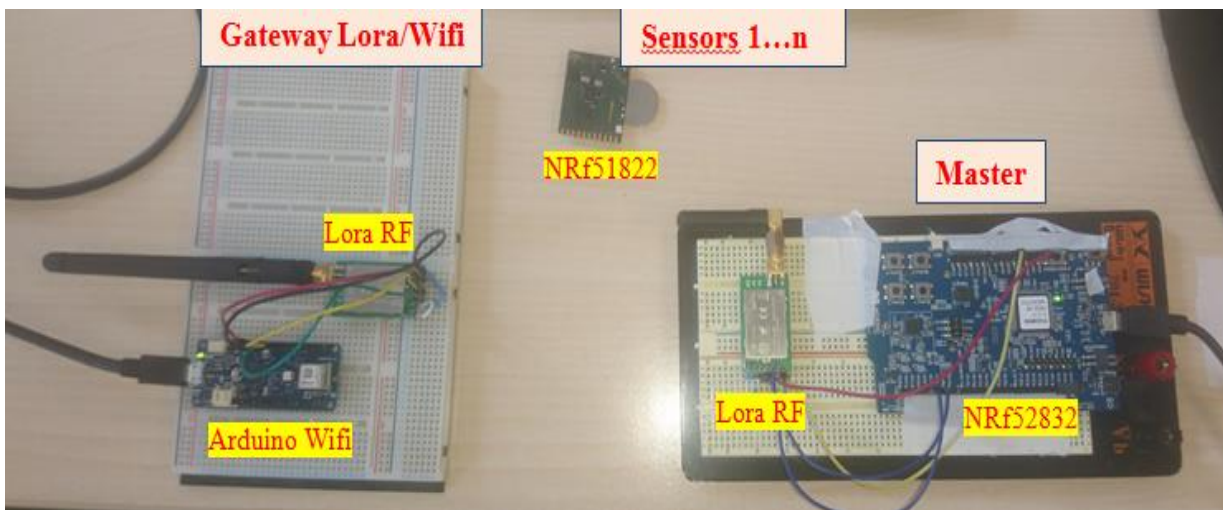

Figure 9. System components tested individually and combined.

The different components of the system were brought into interaction during several integration tests in order to synchronize the exchange and transmission speed taking into account the different types of communication used (BLE, Wifi, LoRa). The various errors detected in this way were corrected,

and to avoid the loss of data during transmission, corrective measures were introduced such as acknowledgments of receipt and data retransmission.

Finally, the system components were integrated into packaging with LEDs for signaling. No buttons (except for power on) have been added to facilitate use and operation by medical staff (Figure 10). All possible commands must be executed either locally via the Android application or remotely from the web interface. The L.S.M system is very flexible and scalable. Indeed, a new sensor can be added at any time by a simple configuration.



Figure 10. The final L.S.M system appearance.

2.2 Choice of wireless communication techniques

There are many wireless techniques available, each with its own characteristics and suitable for different application scenarios. We have listed several commonly used wireless communication techniques and their main technical parameters, as shown in Table 7. Several techniques are adopted in our proposed system architecture.

Table 7. Technical parameters of commonly used wireless communication technologies.

Wireless techniques	Spectrum Band	Transmission range	Data rate	Power consumption
BLE	2.4 to 2.4835 GHz	>100 m	0.27 to 1.37 Mbit/s	10 to 500 mW
LoRa	433 MHz, 868 MHz (Europe), 915 MHz (Australia and North America), 865 MHz to 867 MHz (India) and 923 MHz (Asia)	4.8 to 14.4 km in rural areas; 1.6 to 4.8 km in rural areas	0.3 kbit/s to 27 kbit/s	25 mW
NB-IoT	800MHz/900MHz	15 to 35 km	160 kbit/s to 250 kbit/s	100 mW
WiFi	2.4/5 GHz	20 m indoor; 150 m outdoor	600 to 9608 Mbit/s	100 to 500 mW
ZigBee [128]	868/915 MHz and 2.4GHz	50 to 300m	250 kb/s in 2.4 GHz, 20 kbit/s in 868 MHz, 40 kbit/s in 915 MHz	10 to 100 mW
Sigfox	868MHz (Europe), 902MHz (the US)	20 to 50km	0.1 kbit/s to 0.6 kbit/s	30 mW

The communication between sensors and master board is through BLE. The sensors and master board are designed to be in the same room when system works. Therefore the transmission range of the wireless technique is unnecessary to be long. The BLE and WiFi are both suitable for indoor communication scenarios with relatively short transmission range. However, the WiFi has much higher data rate and power consumption as shown in Table 7. As the data rate of BLE can meet our requirement for the sensors' data transmission, the BLE is adopted. For the similar reason, the communication techniques between the smartphone application "L.S.M" and the master board also uses BLE.

The communication between master board and gateway is through LoRa. When the room where the user under sleep monitoring by our system can't access to the Internet, the gateway will be put in another place where it can access to the Internet so that to upload the sleep monitoring data to database. As a consequence, the distance between gateway and master board could be several kilometers. The transmission range of LoRa and NB-IoT (Narrow Band Internet of Things) [126] techniques can meet this requirement. However, the data rate and power consumption of NB-IoT are much higher than LoRa. As the data rate of LoRa is enough to transmit the sleep monitoring data and considering the life of battery, LoRa seems better. Sigfox [127] is also a widely used IoT

communication technology with a long transmission range and low power consumption. However, Sigfox requires an additional monthly fee, which is more costly than LoRa. In addition, unlike LoRa, which is open, Sigfox's network can only be deployed by the operating company, while LoRa's network can be built by individuals themselves. Therefore, LoRa is more flexible than Sigfox and more suitable for personal application scenarios, while Sigfox is more suitable for public application scenarios. Clearly, in personal application scenarios such as sleep monitoring, LoRa seems to be the better choice.

The communication between gateway and database is done through Internet. WiFi is the most widely used Internet access technology; we choose to use WiFi to connect the gateway to the Internet. In addition to WiFi, the gateway can also be directly connected to the Internet by directly using the 2g/3g/4g/5g service provided by the network operator, but this method requires a separate SIM (Subscriber Identity Module) card for each gateway device and a separate monthly network usage fee. The cost is high. When using WiFi, multiple gateway devices can share one WiFi hotspot and only pay one network fee.

After defining the overall architecture, the details of technical and development of sub-system including sensors, master board, gateway and Android application “L.S.M” (LAAS Sleep Monitoring) are described as follows.

2.3 Hardware system

According to the methodology adopted to meet the specifications, and after a study of the various technical possibilities corresponding to the defined logical architecture (the subsystems), the overall hardware architecture is presented in Figure 11.

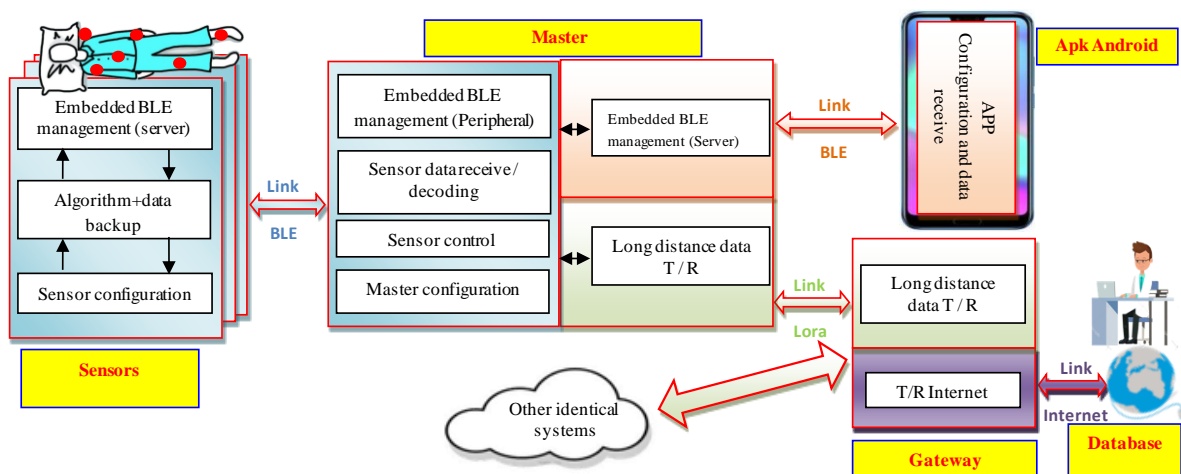

Figure 11. Overall hardware architecture of the proposed SMS.

2.3.1 Sensors

The data acquisition of the system are realized by various sleep monitoring modules, and each sleep monitoring module uses specific sensors to collect important physiological data related to sleep. Table 8 lists technical information for each sleep monitoring module. A more detailed description for each module is presented in section 2.4 of this chapter.

Table 8. Technical information of sleep monitoring modules.

sleep monitoring modules	Sensors used	Position on body	Parameters to acquire
Chest module	Accelerometer (ADXL362)	Front chest	Sleep position
Wrist module	Accelerometer (ADXL362), Temperature sensor (NTC)	Left wrist	Wrist movement, finger temperature
Heart rate and SpO2 module	MAX30102	Right wrist	Heart rate and blood oxygen saturation (SpO2)
Foot module	Accelerometer (ADXL362), Temperature sensor (NTC)	Left foot, right foot	Foot movement, toe temperature
Sound module	Microphone (MAX9814)	Next to the head within one meter	Sound
Ambient module	Luminosity (TSL2591), Temperature sensor (NTC)	Sleeping room	Luminosity and temperature of sleep environment

The sensors we use are integrated into a miniaturized electronic board (see Figure 12) designed at LAAS [129]. It is positioned at specific positions on the body, with the integrated sensors being chosen according to the parameters to be monitored, as listed in Table 8.

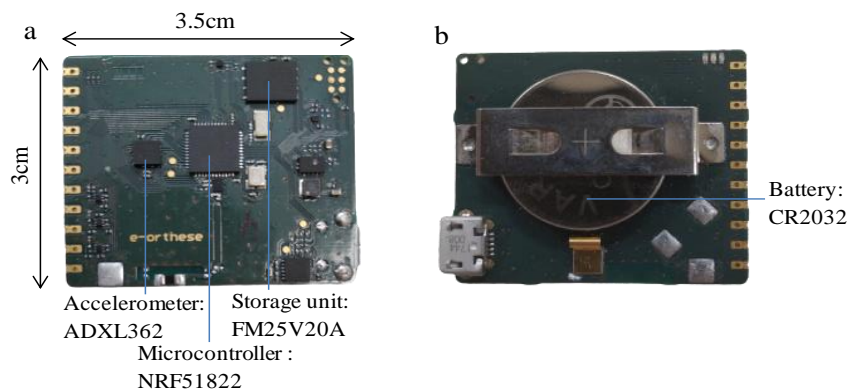

Figure 12. The sensor's basic electronic board. (a) Front side; (b) Back side.

The board is a system-on-chip, connected, and powered by a button cell (3V). Here are the main components we used on the sensor's basic electronic board for sleep monitoring:

-An NRF51822 microcontroller containing a 32-bit ARM Cortex M0 processor and a 256kB flash memory. This microcontroller is equipped with a BLE V4 LE module with a power of +4dBm and a sensitivity of -93dBm, for data transfer.

-16kB non-volatile FRAM memory for data backup during sleep.

-An ADXL 362 low consumption triaxial accelerometer.

-I/O ports for interfacing with other sensors, depending on the parameters to be observed.

Programming is done in C using Keil μ Vision.

2.3.2 Master board

The master board is the control and data collection center of the proposed SMS. When the SMS is running, just place it in the room where the sleeper is, as shown in Figure 13.



Figure 13. Illustration of the master board location.

The master board carries out five tasks:

- 1) Reception of operating commands, including the search of sensors (discovery phase), connection and disconnection of sensors (connecting phase) via BLE from a custom smartphone application.
- 2) After connecting with the sensors, receive control commands from the custom smartphone application via BLE to set the operating modes of the sensors. The sensor operating modes include work on, work off and data transmission (data exchange).
- 3) Reception and gathering data from the sensors.

- 4) Gathering ambient luminosity and temperature data from sensors integrated in the master board.
- 5) Send all collected data to the gateway via LoRa network.

To perform these tasks, the master board (Figure 14) consists of:

- A 32-bit nRF52832 (ULP) microcontroller, which contains an ARM Cortex M4 processor, 512 KB Flash memory and 64 KB RAM memory. It is equipped with a BLE V4.2 LE module with a power of + 4dBm and sensitivity -96dBm, for data transfer and is able to establish 8 simultaneous BLE connections.
- A LoRa SX1276 Wireless RF 868 MHz transmitter / receiver with a sensitivity of -146.5 dBm20 and a power of +20 dBm.
- Ambient temperature (thermistor) and luminosity sensors.



Microcontroller nRF52832



Module Lora RF



Luminosity sensor TSL2591



CTN AVX NI24

Figure 14. Master board composition.

2.3.3 Gateway

The gateway is the data transfer station of the system. On the one hand, it is connected to the master board via LoRa and receives the sleep monitoring data sent by the master board. On the other hand, it is connected to WiFi network, transmitting the data received from the master board to any network terminal or database located anywhere via the Internet.

To achieve these tasks, the master board (Figure 15) consists of:

- Arduino MKR WIFI 1010 microcontroller containing an ARM Cortex-M0 + 32-bit processor.
- IEEE WiFi module from the U-BLOX NINA-W10 series.

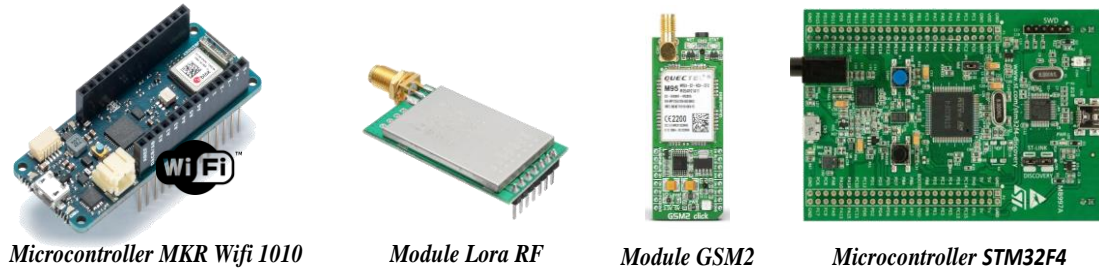

Figure 15. Composition of the Gateway (two versions available: Lora-Wifi and Lora-2G).

The Lora-WiFi Gateway works in T/R (Transmit/Receive) in both directions (Figure 16):

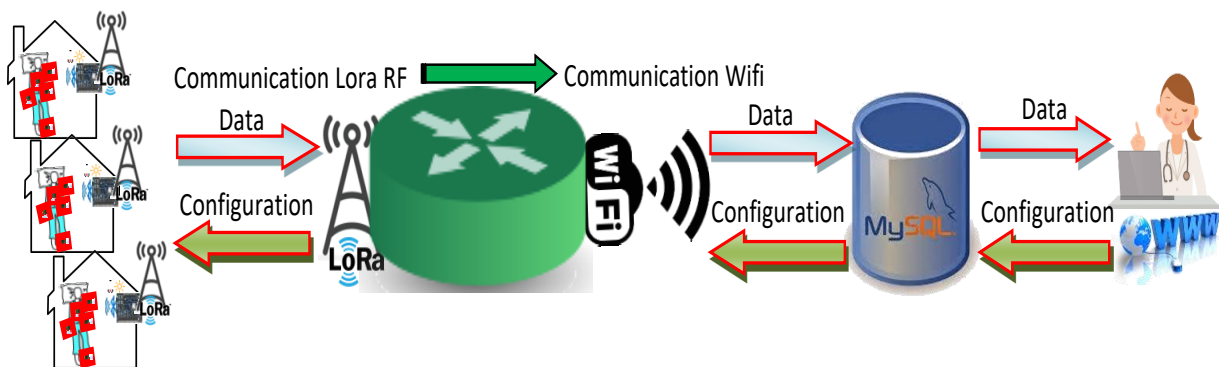

Figure 16. Basic diagram of the Lora-WiFi Gateway.

- Uplink: reception of sensor data from several master boards (differentiated by an Id) via LoRa's RF support and send them to the server (database) via WiFi support for processing and visualization by the web application (Data upload).
- Downlink: reception of configurations from the web application via the WiFi support and send them to the concerned master board (designated by its Id) via LoRa RF support for its own configuration and sensors configurations (remote configuration).

As it is a customized gateway, specific have been defined with custom preambles (&... \ n: in uplink, @ ... \ n: in downlink), headers (source, destination...), data fields and sizes. The Gateway software is in charge of forming the frames and distributing them according to their destination.

The Wifi and LoRa connections are essential for the gateway operations. The gateway does not record data, therefore the gateway always checks the availability of the different connections. If one of its connections is down (no WiFi signal, etc.), it interrupts its operation to initialize and repair the connection concerned (Figure 17).

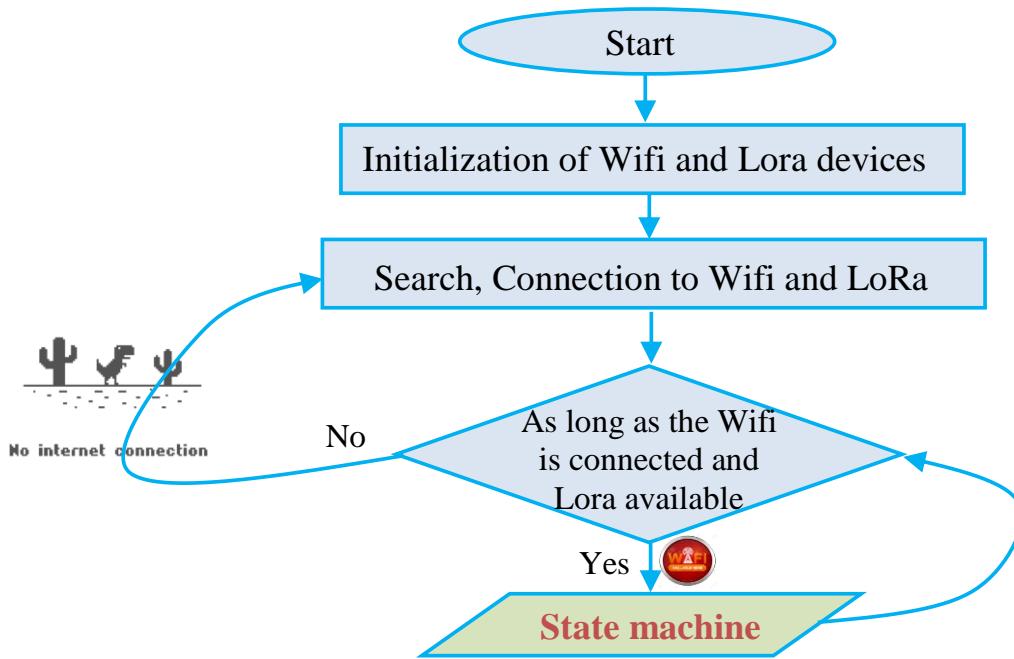

Figure 17. General operation of the gateway.

The protocol used for WiFi communication with the server (database) is the http protocol, which works on the "request-response" principle. The Arduino WiFi module communicates via a temporary PHP file that receives data from the gateway and distributes it to the different tables in the database according to various parameters (sensors, data type, patient, etc.). The gateway is always listening to receive a frame, either by WiFi (configuration) or by LoRa (sensor data). As soon as it detects that this is a frame header specific to our system, it decodes it and sequentially forms a new frame in order to distribute it to its recipient. The simplified overall operation of the Gateway is managed by a state machine shown in Figure 18.

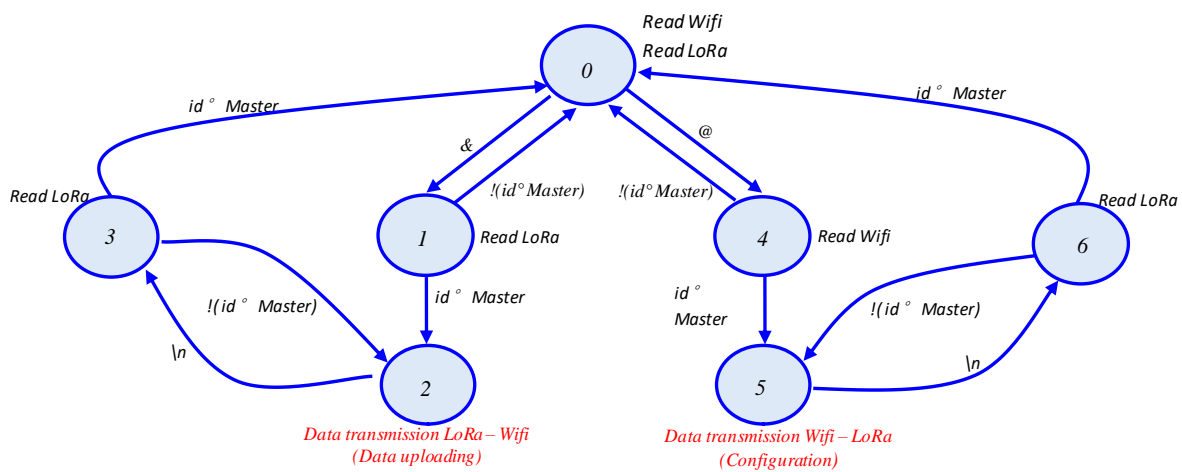

Figure 18. Gateway state machine and data flow.

At the end of the transmission of all sensors data, the master sends a “flag” to the database to trigger calculations and data processing. The algorithms are implemented in python language and launched by a "Crontab" on a web server. The results of the processing on the sensor data give access to sleep indicators that allow to determine a global sleep index by crossing the different indicators (sleep score, as we will see in Chapter 4).

2.3.4 Android application

Given the availability and democratization of the use of tablets and smartphones, we have decided to develop an Android application “L.S.M” (LAAS Sleep Monitoring) with the system for controlling and viewing surveillance data. The application will be used by medical personnel or by patients.

The application allows interaction between a smartphone running on Android that will act as a "BLE Device" and the Master board (NRF52832 microcontroller) that will act as a "BLE Server". The application has been built in the Android Studio mobile application development environment. This application can be launched on any version of Android that supports BLE communications (API above level 18), regardless of screen size.

The application allows users to perform the following basic operations:

- Scanning: searching for BLE devices.
- Filtering: filter found devices according to the BLE services they have as well as their name to identify only specific devices (type S4M-MASTER).
- The BLE connection to a GATT (Generic Attribute Profile) server of a specific type S4M-MASTER device.
- Sending data to a BLE service.
- Receiving data by "Read" or "Notification".

According to the specifications, the graphical interface of the application has been adapted for user-friendly approach without requiring special skills with visual indications and animations to guide the user (doctor, nurse, patient, etc.).

The graphical interface is divided into several pages to simplify the use of the application for the user (Figure 2.10). It allows the following operations to be carried out:

- Scanning and connection: this function allows the user to search for compatible BLE type LAAS-S4M devices that are broadcasting as well as to connect to them.
- Data Upload: This function allows to retrieve sensor data by notification.

- Configuration: allows to carry out all the Master board and Sensors configurations, these configurations are grouped into several categories:
- General configuration: switch ON/OFF all systems (storage status), view existing sensors, know the status of the sensors batteries...
- Commands: switch ON/OFF, Stop advertising.
- Configuration of the number of sensors, and of acquisition frequencies.
- Time configuration: Time Now, Time On, Time OFF.
- Activation or deactivation of the audible alarm to wake up the person at the Time OFF.
- Configuration of sensors and Master passwords.

Figure 19 shows the interfaces of the Android Application “L.S.M”.

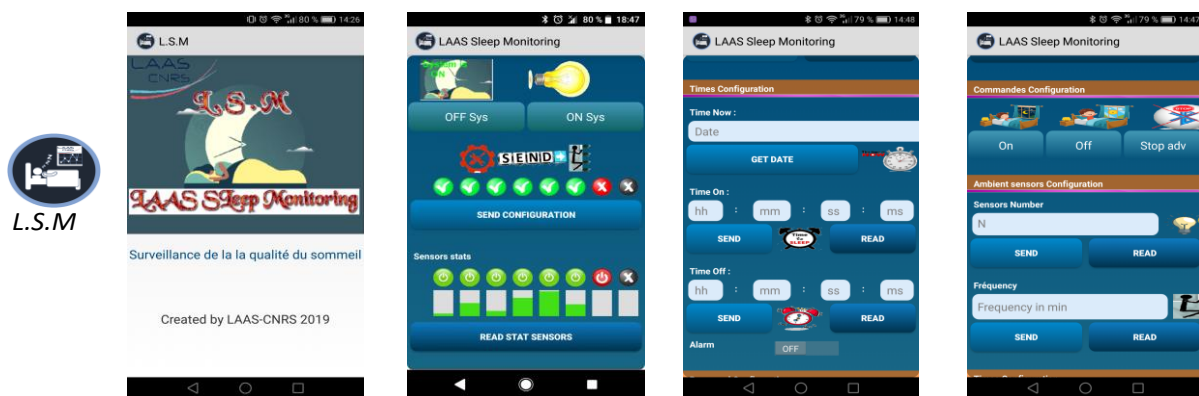

Figure 19. The interface of the Android Application “L.S.M”.

2.4 Sleep monitoring modules

The sleep monitoring modules are the essential elements of the SMS we propose. They collect the raw data necessary for sleep monitoring. In section 2.1, we briefly mentioned the sensors used by all sleep monitoring modules, where they are placed on the body and the data collected. In this section, we will present each sleep monitoring module in more detail.

2.4.1 Chest module

The chest module consists of a smart module and a temperature sensor (negative temperature coefficient, NTC), as shown in Figure 20(a). It is wrapped in soft paper and attached to the front of the chest with medical tape, as shown in Figure 20(b). This module is designed to measure chest temperature and detect the sleeping positions.

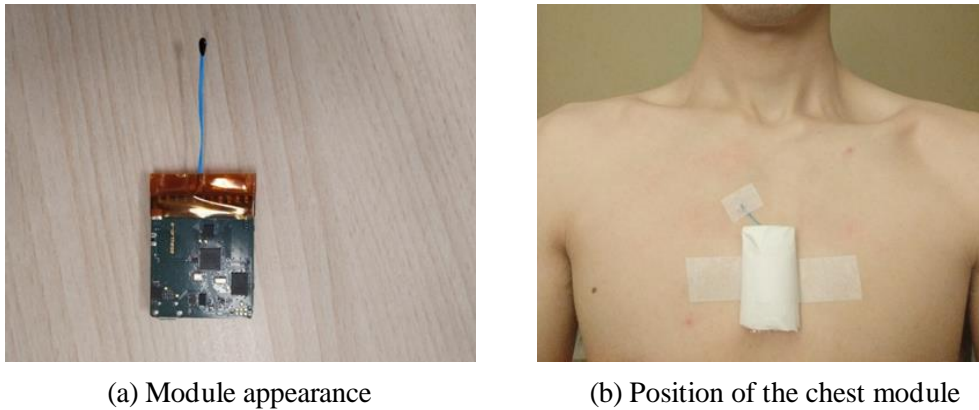

Figure 20. Chest module.

2.4.2 Wrist module

The wrist module consists of a smart module and a temperature sensor (negative temperature coefficient, NTC), as shown in Figure 21(a). It is wrapped in soft paper and worn on the non-dominant wrist like a watch. The temperature sensor is attached to the index finger by medical tape, as shown in Figure 21(b). This module is designed to measure the temperature of the fingertrips and record data concerning wrist movements.

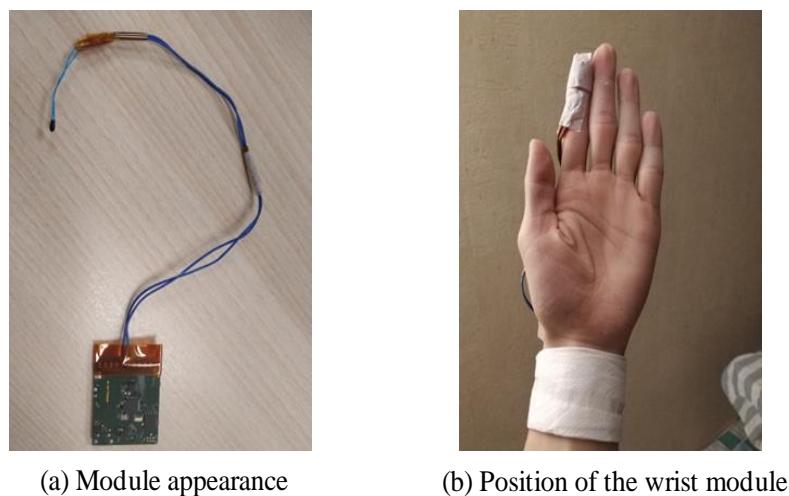

Figure 21. Wrist module.

2.4.3 Foot module

The foot module consists of two sub-modules: sub-module *a* and sub-module *b*. Sub-module *a* consists of a smart module and a temperature sensor (negative temperature coefficient, NTC), as shown in Figure 22(a). Sub-module *b* consists of one smart module only. The two sub-modules are wrapped in soft paper and attached on two insteps (sub-module *a* is on the left instep, sub-module *b*

is on the right instep) as shown in Figure 22(b). The temperature sensor in sub-module *a* is attached to the big toe with medical tape, as shown in Figure 22(c). Sub-module *a* is designed to measure the temperature of the extremities of the toe and record foot movement data, sub-module *b* records only foot movement data.

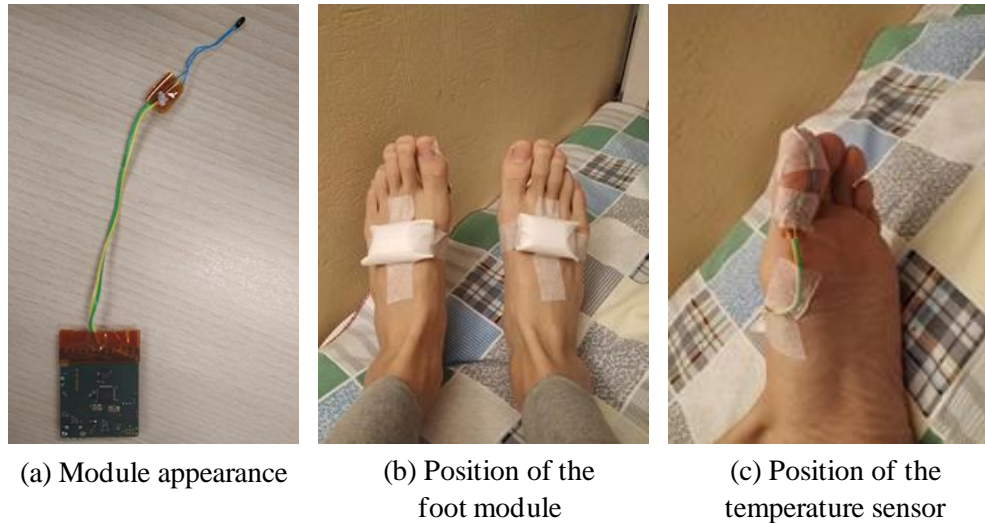

Figure 22. Foot module.

2.4.4 Ambient module (Luminosity and Temperature)

The ambient module can measure the temperature and luminosity of the sleeping environment. Both sensors are integrated in the collector box, as shown in Figure 23(a). They are located at the top of the collector box, as shown in Figure 23(b). The temperature sensor is also a Negative Temperature Coefficient (NTC) sensor, the luminosity sensor is a TSL2591, as shown in Figure 23(c). The temperature data and luminosity data will be collected every minute.

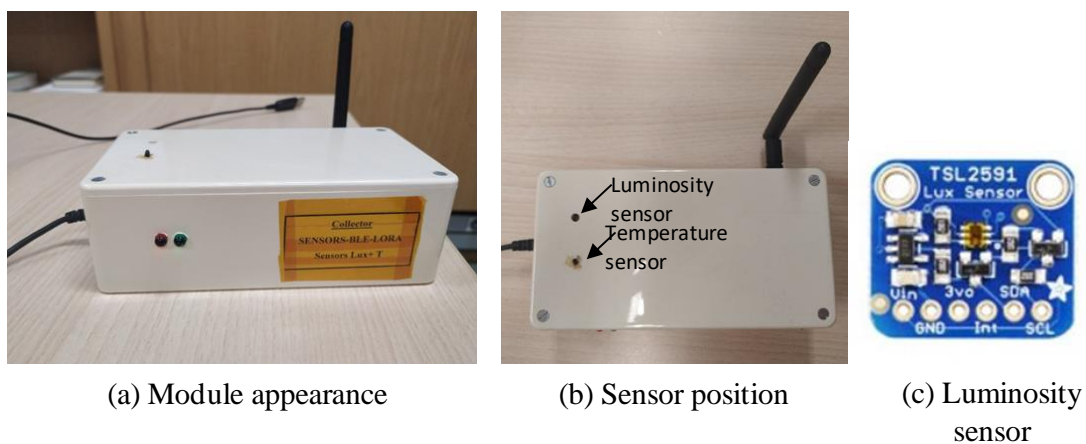

Figure 23. Ambient module.

2.4.5 Sound module

The sound module collects sound data using a MAX9814 microphone, as shown in Figure 24(b). It is powered by two 03-2032 batteries to ensure continuous sound data collection throughout the night. The appearance of the sound module is shown in Figure 24(a). It is placed next to the head within one meter during monitoring, as illustrated in Figure 24(c). Sound level data is collected every second.

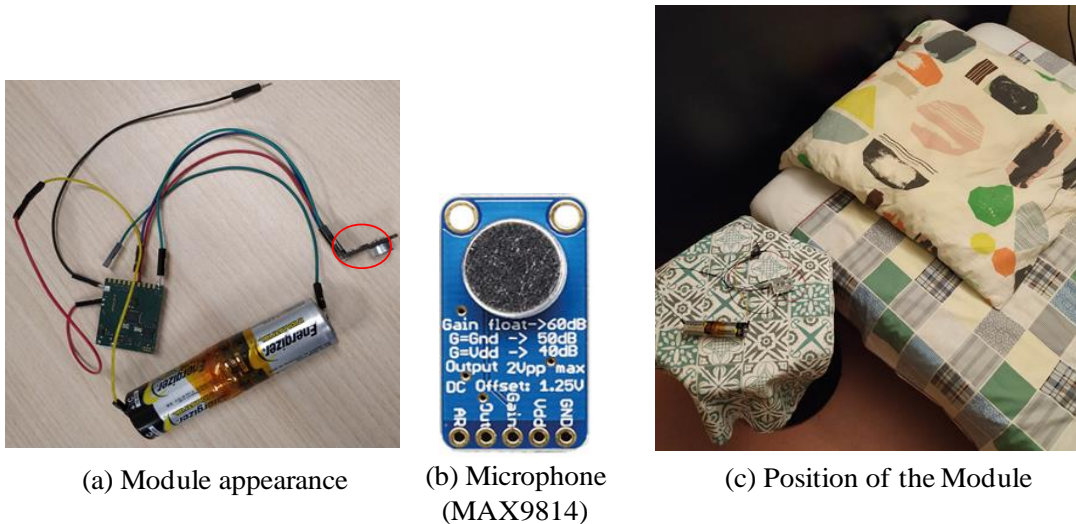
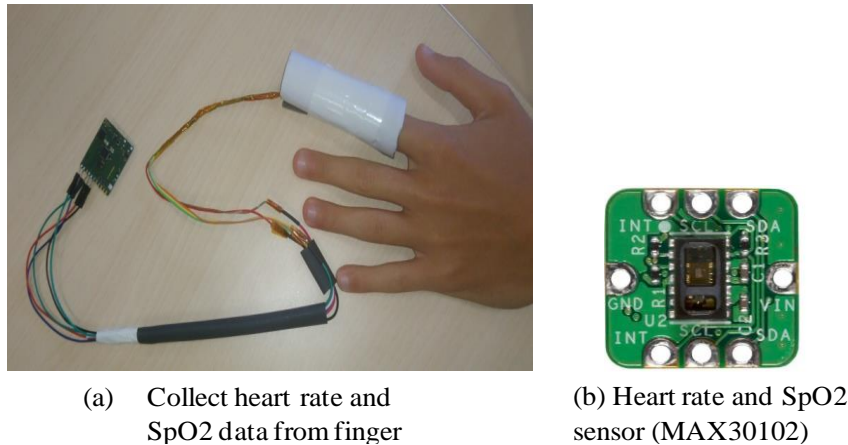

Figure 24. Sound module.

2.4.6 Heart rate and SpO2 module

The heart rate and SpO2 module monitors heart rate and blood oxygen saturation (SpO2). To meet the need for heart rate and blood oxygen monitoring while ensuring battery life, we have selected the MAX30102 sensor (Figure 25(b)) operating in I2C and allowing these functions to be performed with minimum power consumption and a 1.8V supply. It is an optical biosensor that integrates a red LED (660 nm), an infrared LED (880 nm) and a photodetector. Data are collected from the finger (Figure 25(a)). Its operating principle is based on the absorption properties of hemoglobin in the blood. Oxygenated hemoglobin absorbs more infrared light than red light, while deoxyhemoglobin absorbs more red light than infrared light. Therefore, the red and infrared LEDs of the oximeter emit light alternately, and the photodiode receives an optical signal that is not absorbed. The ratio between red and infrared light received by the photodiode is used to calculate the percentage of oxygen in the blood. The heart rate is also determined by the pulsating nature of the arterial blood flow.



(a) Collect heart rate and SpO2 data from finger

(b) Heart rate and SpO2 sensor (MAX30102)

Figure 25. Heart rate and SpO2 module.

3 Conclusion

This chapter presents the overall hardware and software (with the exception of computation engine) architecture of our SMS proposal. The overall hardware architecture includes sensors, a master board, a gateway and a smartphone application. The sensors are integrated into several sleep monitoring modules, including a chest module, a wrist module, a foot module, a sound module and an ambient module, to enable the acquisition of sleep related data. The master board collects all data acquired by the sensors via BLE and sends it to the gateway via LoRa. After receiving the data sent by the master board, the gateway can send it to the database for data storage via WiFi. Thus, doctors or users can check the sleep monitoring results through a web page by accessing the database anytime and anywhere. The smartphone application is developed to help users to send commands such as switching the system on and off and transmitting data with a simple smartphone operation.

Since BLE is a short-range transmission technology (around 10 meters in open field), the master board must be placed in the same room as the monitored user. However, the gateway can be placed anywhere within the range of 2-10 km from the master board, as the transmission range of LoRa communication technology is 2-10 km. Since the system needs to connect to WiFi to send sleep monitoring data over the Internet, users who do not have WiFi coverage available in their living environment can find a place with a available WiFi coverage within 2-10 km from where they live and place the gateway there to ensure normal operation of our sleep monitoring system. This is very useful for areas where network construction is relatively undeveloped.

Work on the specification of the overall architecture required to perform sleep monitoring was discussed. The system designed is easy to be used by medical staff or even non-specialists. In

particular, it facilitates sleep monitoring at home and provides doctors with detailed measurements over a longer period of time than conventional hospital observations. Various functionalities such as sleep data acquisition with the sleep monitoring modules, collection of data acquired by each sleep monitoring module with the master board, system control with a customized smartphone application and remote data transmission with the gateway required by the specifications have been validated. In addition, the project was fully documented. Finally, the system was built following the advice of sleep specialists from the Toulouse center hospital. The Toulouse center hospital gave us the opportunity to test the system on site, at the sleep unit, in March 2020 , for comparison with the PSG gold standard. These results will be presented in chapter 5.

Chapter 3. Definition and detection of sleep indicators

1 Introduction

Sleep quality can be reflected by sleep indicators. As sleep is a complex physiological phenomenon, a single indicator is not enough to measure sleep quality. For a SMS, it is very important to select and define an appropriate number and type of sleep indicators. Many indicators are needed to assess sleep quality from different perspectives. The sleep indicators we propose refer to the Pittsburgh Sleep Quality Index (PSQI) [130]. The PSQI was proposed in 1988, by researchers at the University of Pittsburgh [130]. It is a self-assessment questionnaire that evaluates sleep quality over a one-month period. It consists of 19 items, measuring several aspects of sleep, and offers seven scoring items and a composite score. The seven scoring items include:

1. Subjective quality of sleep
2. Sleep latency (i.e., the time it takes to fall asleep),
3. Sleep duration,
4. Usual sleep efficiency (i.e. the ratio of sleep duration to total duration in bed. It is calculated by dividing the amount of time spent asleep (in minutes) by the total amount of time in bed (in minutes).),
5. sleeping disorders,
6. Use of medicines for sleep,
7. Daytime malfunction.

Based on the PSQI (Pittsburgh Sleep Quality Index) questionnaire [130] and the recommendations of the sleep experts at the Center Hospital of Toulouse, we have defined six sleep indicators. These are sleep stages, sleep position, snoring, periodic leg movement index (PLMI) (the number of periodic leg movements per hour over the total sleep duration), skin temperature (finger, toe and chest) and ambient condition (luminosity and temperature). These indicators are all correlated to the sleep. The choice of these six indicators is explained and justified below.

For the **sleep stages**, obtaining the time spent in the different sleep stages can provide better information to guide behavioral changes and recommendations to improve sleep quality [131]. It is therefore very important to obtain the overnight sleep hypnogram.

Several studies have analyzed the influence of **body position** on sleep. In [132], Arbinaga et al suggests that people who stated that they sleep on the right side appear to have lower sleep quality than the left-side group. Besides, a close relationship between sleeping position and sleep apnea has been demonstrated. For patients with obstructive sleep apnea (OSA), 25% to 70% of them reported that OSA was more severe in the supine position than in the non-supine position [133][134]. Hence, it's essential to monitor the body position during sleep, especially for people with sleep apnea.

Snoring is produced by the vibration of the respiratory upper airway during sleep, and can affect the quality of sleep [135]. Moreover, as a typical sign of sleep apnea, snoring monitoring may help people become aware of sleep apnea at an early stage. This is why we propose a snoring detection algorithm that can detect snoring during sleep.

Restless Legs Syndrome (RLS) is a sensorimotor disorder that often has a profound impact on sleep [136]. The severity of the symptoms varies greatly from an occasional stressful situation to a serious night-time situation, until total sleep disruption. In a recent study that followed 100 patients with RLS and 50 normal controls [38], 84% of patients had a PLMI greater than 5 and 70% had a PLMI greater than 10, compared to 36% and 18%, respectively, for controls. This suggests that PLMS (Periodic limb movement during sleep) is the typical symptom of RLS, the PLMI measure can be used to predict RLS. This is why we have developed our foot module to detect PLMS in order to obtain **PLMI**. The prevalence of RLS was 5.5% and that of PLMS (Periodic limb movement sleep) was 3.9% [37]. RLS and PLMS concern more women than men and the prevalence of RLS increased significantly with age [38].

The links between sleep patterns and **proximal and distal skin temperature** have been discussed in some studies [110][137]. In their study [110], Van et al discussed the relationship between sleep and body and skin temperature. They reported that core body temperature is lower during our usual sleep period than during our usual wake period, but skin temperature has the opposite tendency. Their study shows that there is probably a correlation between body and skin temperature and sleep. It may be possible to predict sleep status by monitoring body or skin temperature during sleep. For this reason, we measured skin temperature in three body positions, including the distal skin temperature on fingers and toes and proximal skin temperature on chest, to study their correlation with sleep.

The **luminosity and temperature of the sleep environment** can have a significant effect on sleep. It is reported that bright artificial light suppresses the nocturnal secretion of melatonin, a hormone mainly released by the pineal gland that regulates the sleep–wake cycle [138][139][140]. In addition,

the ambient temperature is an important determinant of sleep as thermoregulation is strongly linked to the sleep regulation mechanism [141]. An ambient temperature that is too high or too low could affect sleep even for healthy people without insomnia. This is why we propose a module for monitoring light and ambient temperature to find out whether the sleeping environment is suitable.

2 Definition of sleep indicators

The PSQI is now being used by researchers working with people from adolescence to the end of life. Clinical studies have found that the PSQI is, to some extent, reliable and valid in the assessment of sleep problems. However, the PSQI suffers from the same problems as other self-assessment questionnaire, in that scores can be easily exaggerated or minimized by a person's subjective feelings. It is therefore very useful to propose objective measurement methods for these items. The proposed sleep monitoring system can measure several sleep indicators from many perspectives, and these sleep indicators can provide an objective measure of the 1 - 5 scoring component in the PSQI. Sleep indicators detected by our system include:

1. Sleep stages
2. Sleeping position
3. Snoring
4. Periodic leg movements during sleep (PLMS)
5. Skin temperature (fingers, toes and chest)
6. Ambient conditions (luminosity and temperature)

For the sleep stages, the algorithms we propose use only the acceleration data of the wrist module, resulting in a classification into 4-sleep stages ("awake", "light sleep", "deep sleep" and "REM"). Algorithms are described in detail in chapter 4. The sleep position is determined by the chest module, the algorithm is described in detail in section 3.1 of this chapter. Snoring is detected by the sound module, the algorithm is described in detail in section 3.2 of this chapter. PLMS is detected by the foot module, the algorithm is described in detail in section 3.3 of this chapter. The skin temperature (finger, toe and chest) is measured by the temperature sensor of the wrist module, foot module and chest module as described in section 3.4 of this chapter. The ambient condition (luminosity and temperature) is measured by the ambient module as described in section 3.5 of this chapter.

3 Algorithms for obtaining sleep indicators

3.1 Sleep position detection

In our proposal, the sleep position is detected by a 3-axis accelerometer ADXL362 in the chest module. By inverting the trigonometric functions it is possible to obtain whether the person is standing up or lying. If he is lying down, the sleeping position can then be determined. We classify the sleep positions into 8 groups. A list of these 9 body positions and their corresponding abbreviations is presented in Table 9.

Table 9. Detected body position and corresponding abbreviation.

Body position	Corresponding abbreviation
Stand up	S
On the back	OB
On the back with right tendency	BR
Right side	R
Right side tends to stomach	RS
On the stomach	OS
Left side tend to stomach	LS
Left side	L
On the back with left tendency	BL

The result of the detection of the body position obtained by our chest module is presented in Figure 26. The data were acquired while the volunteer was undergoing the PSG test on the same night as presented in Chapter 5.

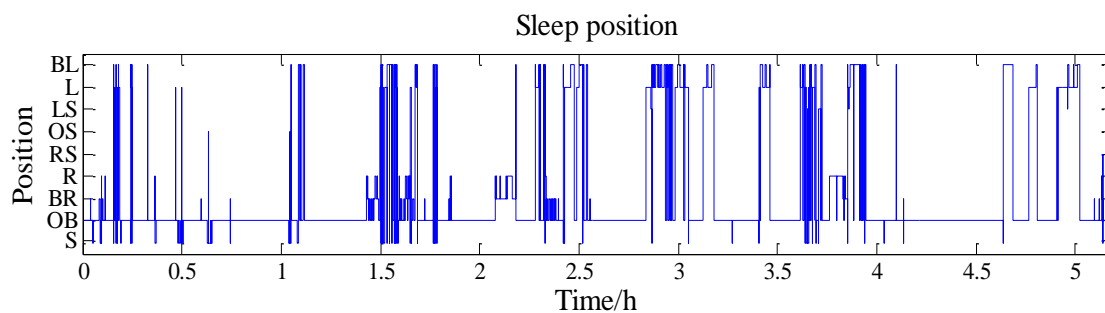

Figure 26. Result of body position detected by our chest module for one night.

Table 10. Time spent in each sleeping position.

Sleep position	S	OB	BR	R	RS	OS	LS	L	BL
Duration (minutes)	6.0	233.0	13.1	7.4	0	0.1	1.7	28.6	21.2

Table 10 shows the time spent in each sleeping position. As we can see, the duration of the OB, BR and BL positions takes the largest part of the total time and the duration of the OS, RS and LS only

takes a very small little proportion of the total time. In addition, the durations of L and R lie between the summation duration of OB, BR and BL and the summation duration of OS, RS and LS. This result is consistent with reality. When people are under PSG monitoring, their whole body is full of electrode lines. In this case, it is very difficult for them to turn their body over. Therefore, the most common position will be to lie on their back or lean slightly to the left or right (i.e. OB, BL and BR). Lying on the stomach or lying on the stomach with a tendency to the left or right side (i.e. OS, LS and RS) will all be rare. The difficulty of lying on the left or right side (i.e. L and R) lies between the back and the stomach, so the probability of occurrence of L and R should be somewhere in between. In summary, our chest module provides a reasonable sleep posture detection result in this test.

3.2 Snoring detection

The snoring detection algorithm is based on sound level data recorded by our sound module. The sound level is recorded by an electret microphone with amplifier MAX9814, microcontroller NRF51822. The sampling frequency of the sound level is 1 Hz. The real environment of the sound level recording is shown in Figure 27. The acquired sound level data is stored in the FRAM during monitoring. After the monitoring is completed, all data in the FRAM will be sent to a PC via Bluetooth for further processing.

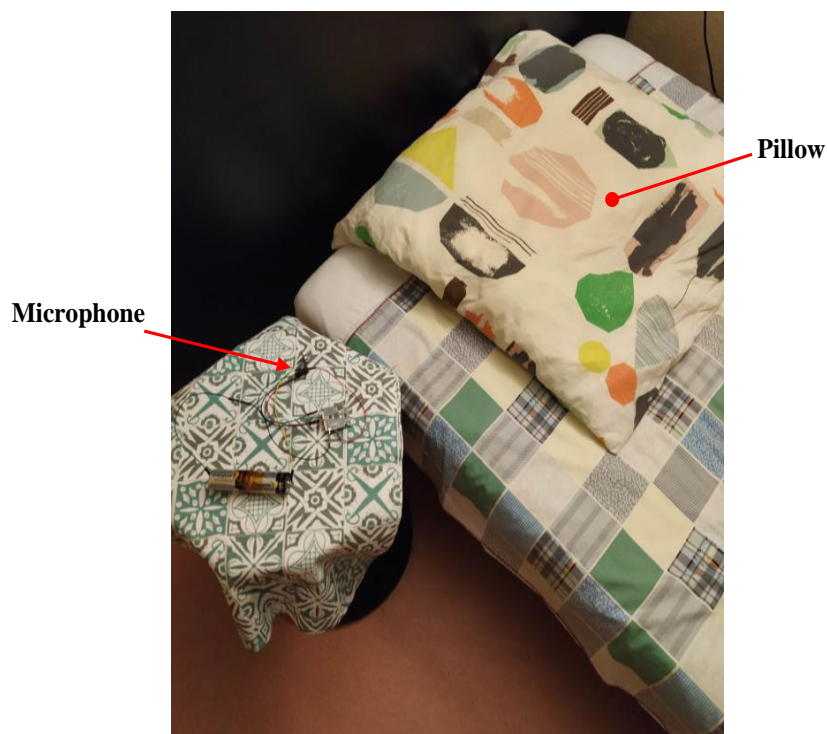

Figure 27. Real environment of the sound level recording.

3.2.1 Method

At a first step, we divide the overnight sound level recording $OvnRcd$ into equal length epochs from the beginning to the end using a rectangular window with no overlap as described in equation (3-1). Each epoch consists of 30 samples, a 30-second sound level recording, according to equation (3-2), where N is the total number of epochs. The goal is to determine whether or not an epoch contains snoring.

$$OvnRcd = \{ep_1, ep_2, ep_3, \dots, ep_N\} \quad (3-1)$$

$$ep_l = \{spl_{l1}, spl_{l2}, spl_{l3}, \dots, spl_{l30}\}, l = 1, 2, 3, \dots, N \quad (3-2)$$

Each sample of an epoch is reduced by the mean value of all 30 samples of that epoch to remove the direct-current component, according to equation (3-3).

$$spl_{l0m} = spl_{lm} - \frac{\sum_{h=1}^{30} spl_{lh}}{30}, m = 1, 2, 3, \dots, 30 \quad (3-3)$$

By observing Figure 28, it can be seen that the epoch with snore (Figure 28(a)) is more quasi-periodic so that power can be concentrated over a certain frequency range. Therefore, the power spectrum based on DFT (discrete Fourier transform) is used to discriminate epochs with snore in the frequency domain. First the DFT (discrete Fourier transform) is performed for the sound level samples of each epoch, as in equation (3-4), then the power spectrum is calculated by the periodogram method, as in equation (3-5).

$$SPL_l(k) = \sum_{n=0}^{29} spl_{l0n} e^{-\frac{2\pi i}{30}kn}, k = 0, 1, 2, \dots, 29 \quad (3-4)$$

$$P_l(k) = |SPL_l(k)|^2 \quad (3-5)$$

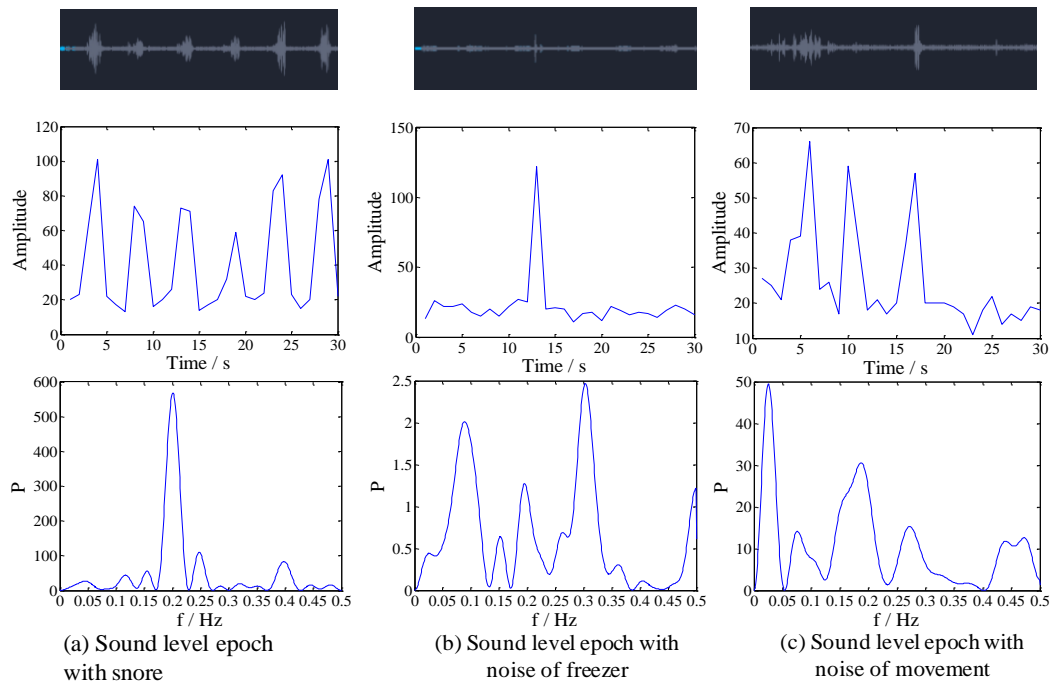

Figure 28. Sound level epoch with snoring, freezer noise and movement noise (top: sound level recorded by a commercial smartphone application “Do I Snore or Grind”; middle: sound level recorded by the smart module with microphone; bottom: power spectrum of the sound level recorded by the smart module with microphone).

By testing many epochs, many differences in the frequency domain are found between the snoring, freezer noise and motion noise epochs. Figure 28 shows the comparison of three representative epochs containing snoring, freezer noise and motion noise respectively. As can be seen, the power spectrum of the snoring epoch has a maximum value at about 0.2 Hz; the epoch with freezer noise has a maximum value at a higher frequency; the epoch with motion noise has a maximum value at a lower frequency. According to the tests carried out for many epochs, this assessment is true in most cases. It is possible to discriminate an epoch with snoring based on this rule. The specific requirements for determining the snoring epochs are described as follow.

For the power spectrum of the epoch with snoring:

- (1) the frequency with the maximum power value is between 0.15 and 0.25 Hz;
- (2) the maximum value is greater than 3 dB.
- (3) The epoch is not classified as “Wake” by the sleep stage classification algorithm based on wrist movements.

Requirement (1) is based on the quasi-periodic snoring, whose sound level curve is usually characterized by a certain range of periods, as shown in Figure 28 (a). Requirement (2) is used to exclude quiet epochs with very low maximum power. For requirement (3), it always determines epochs as no snoring when they are classified as “Wake” by the sleep stage classification algorithm

based on the wrist movements. Indeed, if an epoch is classified as “Wake”, it means that the user is moving around a lot at that time, but in most cases snoring occurs when people are motionless and snoring is usually interrupted by body movement. The procedure for detecting epochs of snoring is described in Figure 29.

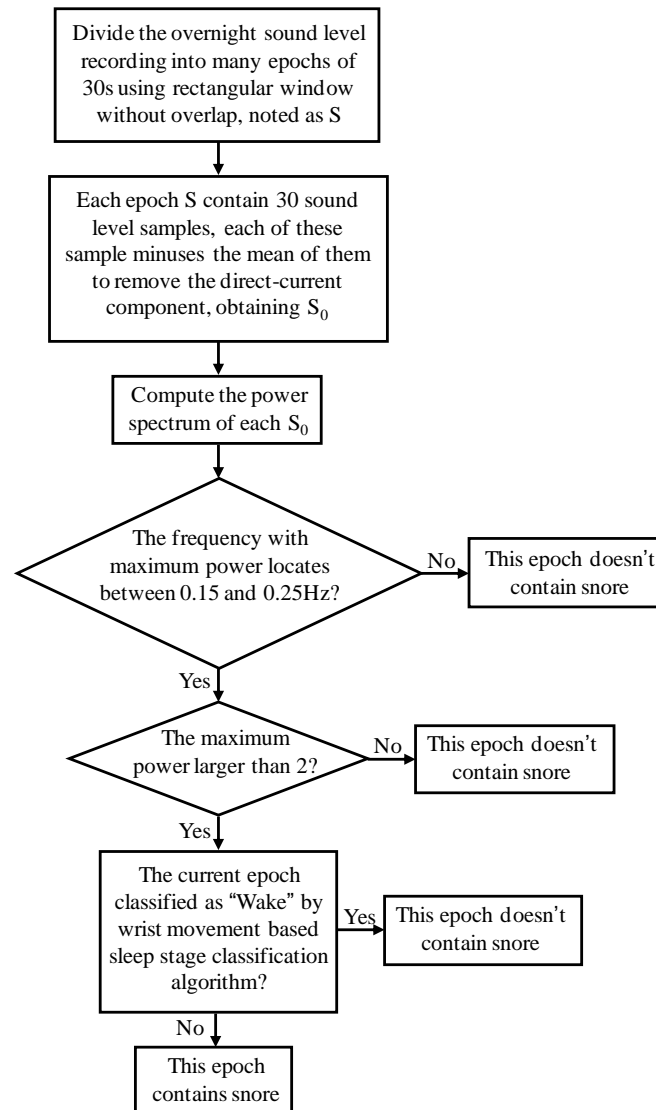

Figure 29. Procedure for the detection of snoring epochs.

3.2.2 Result

The result of snore detection is shown at the bottom of Figure 30. The height of the bar is the maximum value in the power spectrum of the epoch judged to contain snoring. Compared to the result of an APP (*Do I Snore or Grind*) [142], a similar pattern could be found between them, especially before 4am. The biggest difference in result between the APP and the proposed algorithm is around 5 am. As we can see, the APP reports a significant level of snoring but our algorithm does

not report any snoring. Listening to the sound recording around 5 am, we can hear that there is a lot of motion noise but no snoring, which is consistent with the result of the proposed algorithm.

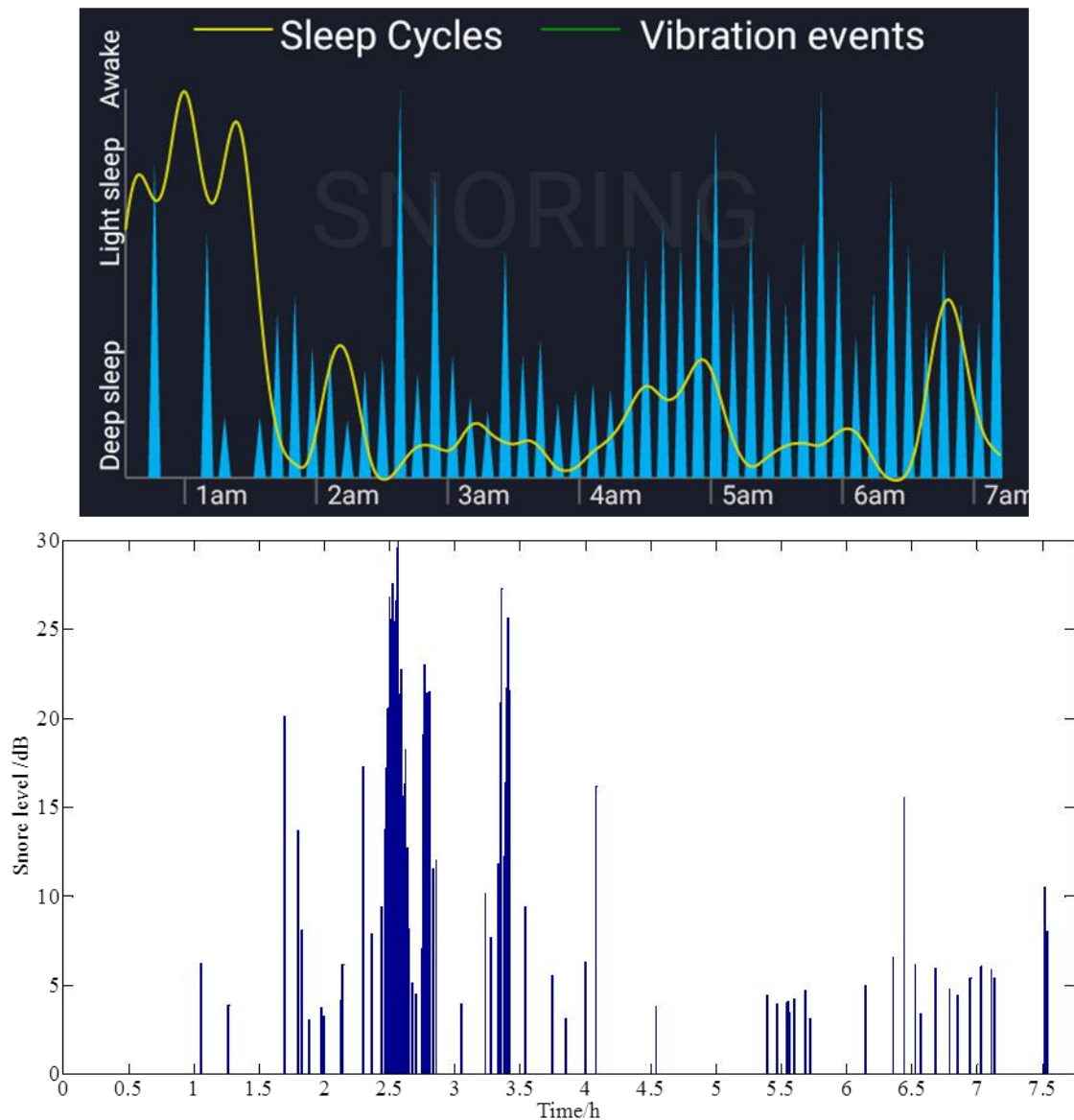

Figure 30. Snoring level provided by the commercial smartphone application “Do I Snore or Grind” (top) and the algorithm presented (bottom).

A sleep report will be generated automatically, which will include the duration of sleep, the proportion of each sleep stage, the timing of the epochs in the different sleep stages, the number of snoring epochs, the duration of the snoring epochs and the timing of the snoring epochs. The screenshot of the report is shown in Figure 31. The report can help the user and the physician with detailed information about sleep.

```

-----
Analysis Result:
Total sleep duration: 464.50 mins(7.74 h)
Duration of each stage:
-Wake:          155.00 mins(33.4 percents)
-Lightsleep:   124.00 mins(26.7 percents)
-Deepsleep:    104.50 mins(22.5 percents)
-REM:          81.00 mins(17.4 percents)

Total number of epochs with snore: 83
Total duration of epochs with snore: 41.5 mins
-----
The time point of snore takes place (the time point means the start point of an 30s epoch):
Time           The time from the start of sleep
0:36:38       (1:7:30)
0:49:8        (1:20:0)
1:15:8        (1:46:0)
1:21:8        (1:52:0)
1:22:38       (1:53:30)
1:26:8        (1:57:0)
1:31:38       (2:2:30)
1:33:8        (2:4:0)
1:41:8        (2:12:0)

```

Figure 31. Snoring detection report screenshot.

3.3 Periodic leg movements (PLM) detection

According to standard criteria [143][144], PLMS are only considered if they are part of a series of four or more consecutive movements lasting 0.5 to 10 seconds with an interval between movements of 5 to 90 seconds and an amplitude greater than 8 mV above the basic signal of an electromyograph (EMG). A PLMS index (number of PLMS per hour of sleep) greater than 5 for the entire night's sleep is considered as pathological [145] and can be used for younger people, but an index greater than 15 is now often used as a threshold for older subjects.

PLMS detection is a commonly used method for the diagnosis of RLS in the sleep laboratory [38]. Based on standard PLMS criteria, the rule for PLMS detection using the ankle module is defined as follows:

- 1) The movement level $M > 21$ (see the definition of M in equation 4.1 of chapter 4) is considered as the emergence of movement.
- 2) When the number of consecutive samples with $M > 21$ is between 1 and 10 it must be considered as a group of movements.
- 3) Adjacent movement groups with an interval of 5 to 90 seconds are considered as significant movement groups. The interval goes from the end of the movement group to the beginning of the next movement group.
- 4) A series of four or more consecutive significant movement groups will be considered as a PLMS group, the number of significant movement groups is the number of PLMS in that PLMS group.

The PLMI is the diagnostic indicator for PLMS based on the foot module. The PLMS detected using our foot module is shown in Figure 32. It is derived from the movement of the left foot. The PLMS is marked by a red vertical line, each red vertical line means one second of time with the PLMS.

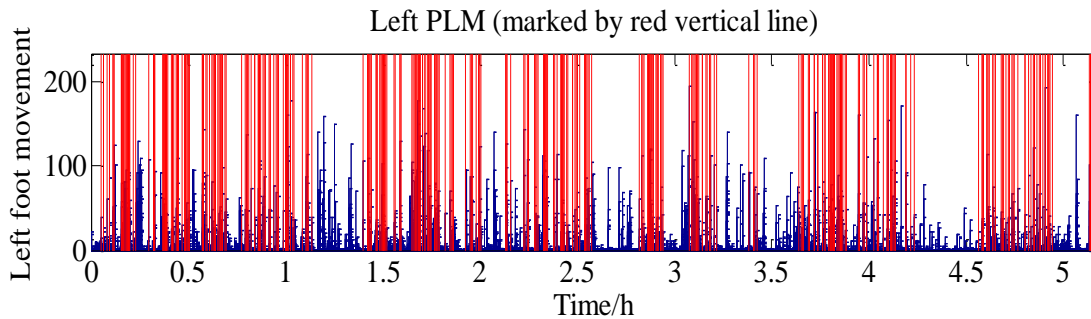

Figure 32. PLMS detected by our foot module.

The performance of PLMS detection was compared to that of PSG, the gold standard. The results are detailed in section 4 of chapter 5.

3.4 Skin temperature (fingers, toes and chest)

The distal skin temperature on finger and toe is acquired by the wrist module and the foot module respectively, the proximal skin temperature on chest is acquired by the chest module. All temperature data is collected every second. Figure 33 shows a recording of the temperature during the night in the three body locations.

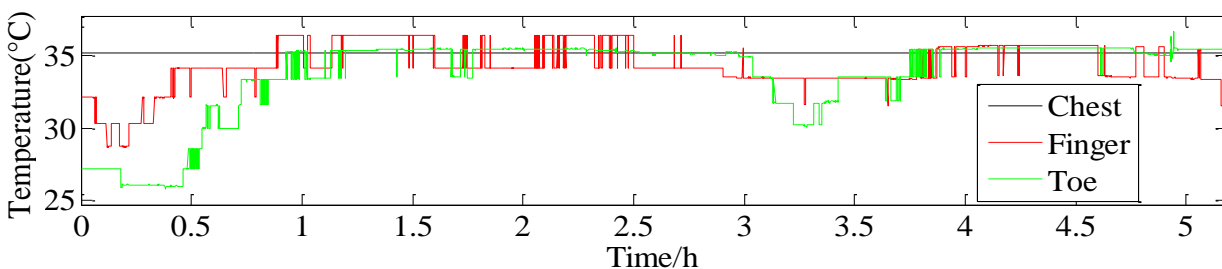

Figure 33. Recording of night skin temperature in three body positions.

The relationship between proximal and distal skin temperature and sleep was studied based on the results of the PSG gold standard. It is described in detail in section 6 of chapter 5.

3.5 Ambient conditions (luminosity and temperature)

Many studies have explored the relationship between sleep and ambient parameters such as temperature and luminosity. In one study [146], a significant deep sleep increase was observed in young women after exposure to a mildly cold environment (after sleep onset), sufficient to reduce core body temperature by 0.2 °C. In another study [147], total sleep time was a mean of 30 min

longer, mean sleep efficiency was higher ($77 \pm 11\%$ versus $71 \pm 13\%$ respectively), and patients were significantly more alert according to the Karolinska Sleepiness Scale in the morning at an ambient temperature of 16°C versus 24°C . Besides, studies have shown that light is a direct stimulant that increases brain activation and alertness [148] and impairs the ability to fall asleep and reduces sleep quality [149]. Therefore, monitoring the temperature and luminosity of the environment could help us determine whether the environment is conducive to good sleep.

Ambient temperature and luminosity data are collected every minute by our ambient module. Figure 34 shows an example of a recording of the ambient temperature and luminosity during the night.

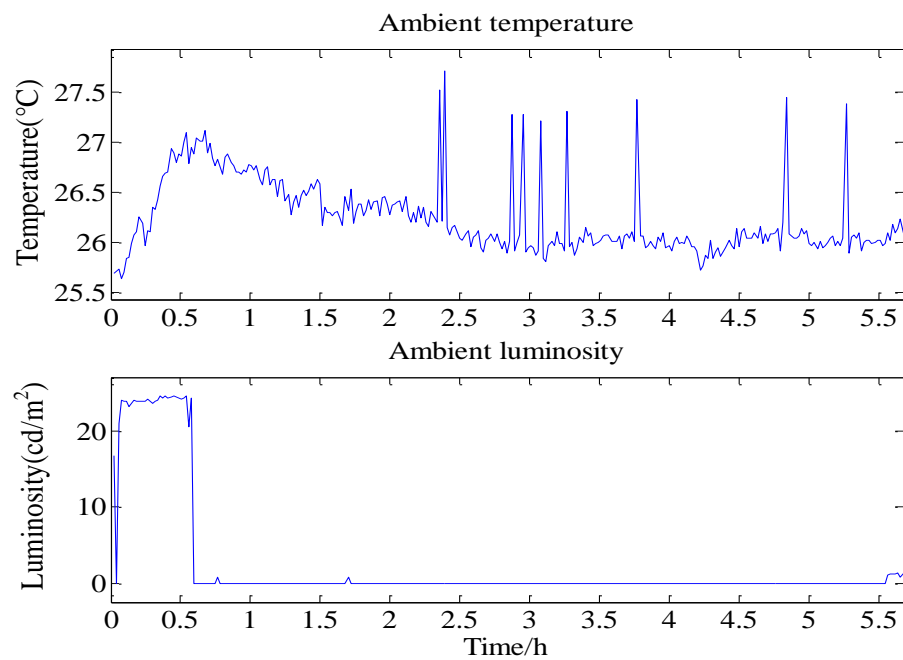

Figure 34. Recording of ambient temperature and brightness during the night.

4 Conclusion

This chapter presents the sleep indicators we propose and the methods to obtain these indicators based on the hardware modules we have developed. The proposed sleep indicators can cover five of the seven scoring items of the PSQI self-assessment questionnaire. Using our hardware modules and the proposed algorithms, we can obtain an objective measure of these sleep indicators to overcome the shortcomings of the PSQI self-assessment questionnaire which all stem from the subjective evaluation. In addition to the sleep indicators included in the scoring component of the PSQI questionnaire, the sleep indicators we propose also include PLMS detection. As a result, compared to the existing conventional sleep monitoring system, the system we propose has a greater potential to detect sleep-related diseases more comprehensively. Finally, all the modules presented in this Chapter have been tested in a real sleep environment during one whole night sleep and will be presented in Chapter 5.

Chapter 4. Sleep stages classification based on wrist movements

1 Introduction

In recent years, the classification of sleep stages has been a subject of in-depth studies, as it is one of the most critical steps in the effective diagnosis and treatment of sleep disorders. Obtaining the time spent in the different sleep stages in the environment of ordinary daily life is of great significance for research and commercial applications. For example, obtaining an accurate sleep architecture can provide better information to guide behavioral changes and provide recommendations for sleep improvement [131].

In the literature, most research adopts supervised machine learning methods that typically require large amounts of learning data to train the classifier and computation to implement the model. However, some works adopt unsupervised methods such as k-means clustering to achieve sleep stage classification. It is usually based on signals directly related to sleep stages such as EEG signal, which is highly intrusive and not easy to collect in a home environment. In this work, we propose a k-means clustering approach using only acceleration data from a wrist-worn sensor to obtain a sleep classification into four classes: awake, light sleep, deep sleep and REM. The k-means clustering method requires a relatively smaller amount of computation [150], which could make the algorithm implementation easier. Moreover, acceleration data from a wrist sensor are very easy to collect. The subject only needs to wear a small and lightweight watch such as the one he or she wears on the wrist, which is very suitable for the home environment and long-term monitoring.

2 Data acquisition and preprocessing

The smart sensing device used was presented in chapter 2. Although the output data rate of accelerometer is 12.5Hz, we sample the output acceleration data only every second. This reduces the amount of data and limits storage space, which could be advantageous for long-term monitoring applications.

We position the smart module on the non-dominant wrist, wearing it like a watch as shown in Figure 35. After switching on the smart module, it will first search for the corresponding Bluetooth slave device (in this case a PC) to try to pair with it. If the smart module can pair with the Bluetooth slave device within 10 seconds (usually 10 seconds is enough for pairing if the Bluetooth slave device is

advertising), it will start to send stored data in FRAM to the Bluetooth slave device for further processing. Otherwise, it will start to acquire acceleration data every second and store it in FRAM.

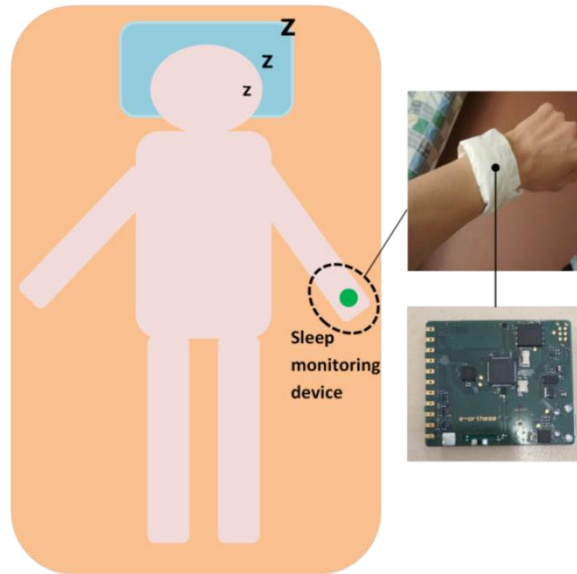

Figure 35. Position of the smart module.

2.1 Data preprocessing

With acceleration values A_x , A_y , and A_z , a corresponding movement level M_i for sample i , will be calculated by equation (4-1), where N is the number of samples for one night.

$$M_i = |Ax_{i+1} - Ax_i| + |Ay_{i+1} - Ay_i| + |Az_{i+1} - Az_i|, \quad i = 1, 2, 3, \dots, N-1 \quad (4-1)$$

The overnight movement level data is cut into 30-samples epochs, noted as S_j ($j = 1, 2, 3, \dots, L$, with L being the total number of epochs for one night). Each epoch is the shortest unit for further sleep stage classification, which has a duration of 30s, as in the Rechtschaffen and Kales Guidelines [151]. Using a sleep stage classification algorithm, each epoch will be classified as follows: awake, light sleep, deep sleep and REM.

For each epoch, movement levels of the corresponding 30 samples are summed to obtain an epoch movement level EM_j , as in equation (4-2).

$$EM_j = \sum_{k=1}^{30} M_{jk}, \quad j = 1, 2, 3, \dots, L \quad (4-2)$$

Where j is the index of epoch, L is the total number of epochs.

As sleep is a constantly evolving process, it is necessary to associate the previous and following periods when analyzing the sleep state at a given time. Thus, for each epoch, 9 epochs are considered before and after it. A weighted PM value is then defined (see equation (4-3)) to further facilitate sleep analysis. Equation (4-3) is inspired by Cole's algorithm. Cole's algorithm calculates the value also as a polynomial summation to distinguish sleep from wakefulness based on wrist activity. The difference is that Cole's algorithm only considers 4 minutes before and 2 minutes after the current epoch to calculate the distinction value. Besides, the coefficients of the polynomial that we have defined change periodically along the term, which can better simulate the characteristic that human sleep also changes periodically, as we have seen from observations.

$$\begin{aligned}
 PM_j = & e^{-0.25}EM_{j-9} + e^{-0.5}EM_{j-8} + e^{-1}EM_{j-7} + e^{-0.25}EM_{j-6} + e^{-0.5}EM_{j-5} + e^{-1}EM_{j-4} + e^{-0.25}EM_{j-3} + e^{-0.5}EM_{j-2} + e^{-1}EM_{j-1} \\
 & + e^0EM_j + e^{-1}EM_{j+1} + e^{-0.5}EM_{j+2} + e^{-0.25}EM_{j+3} + e^{-1}EM_{j+4} + e^{-0.5}EM_{j+5} + e^{-0.25}EM_{j+6} + e^{-1}EM_{j+7} + e^{-0.5}EM_{j+8} + \\
 & e^{-0.25}EM_{j+9}, \quad j = 10, 11, 12, \dots, L-9
 \end{aligned} \tag{4-3}$$

To sum up, the data preprocessing scheme is illustrated in Figure 36.

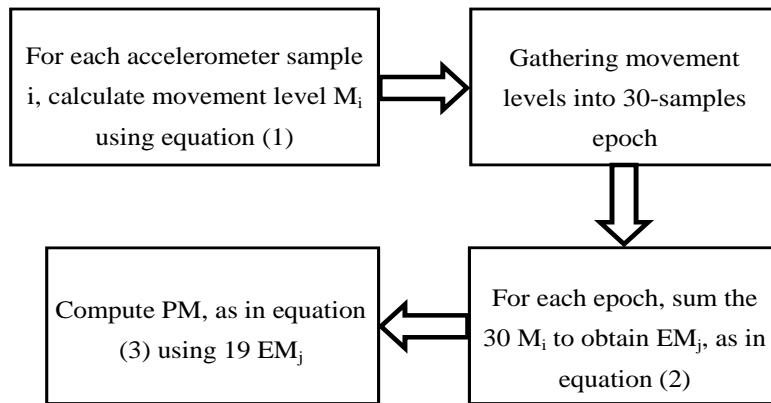

Figure 36. Overnight data preprocessing scheme.

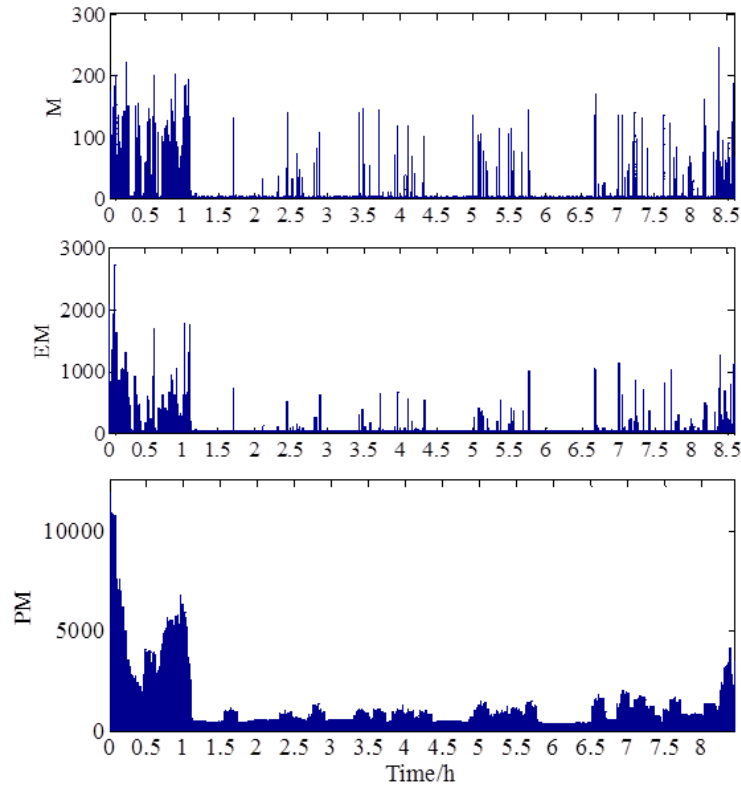

Figure 37. Illustration of M, EM, PM for a same night.

As shown in Figure 37, for one night's data, M is very scattered which further complicates the real sleep analysis. On the contrary, PM has a more orderly data evolution which is helpful for the further sleep stages classification. Based on the calculated PM, we have implemented two methods for classifying sleep stages: a threshold method and a k-means method, as described in the following sections.

3 Threshold method

We have defined 3 thresholds to achieve the classification of sleep stages. In our experiments, we first tried to set different values for the thresholds and then adjusted the values of the thresholds by observing the classification results. After many experiments (10 to 100 times), observations and adjustments, we determined the final threshold values.

3.1 Sleep and Awake discrimination

Wrist movement can be considered as an indicator of the wakefulness state [152]. The amount of wrist movement can therefore be a sign of sleep or awake. We define $T_{S/W}$ as a threshold (Figure 38(a) showing an overnight PM evolution) to discriminate 'Awake' and 'Sleep' epochs, which is 1350 determined from experimental observation and tests. When the PM value of an epoch is greater than

$T_{S/W}$, the epoch is classified as ‘Awake’. Otherwise, it is classified as ‘Sleep’ and the discrimination process continues to refine the classification.

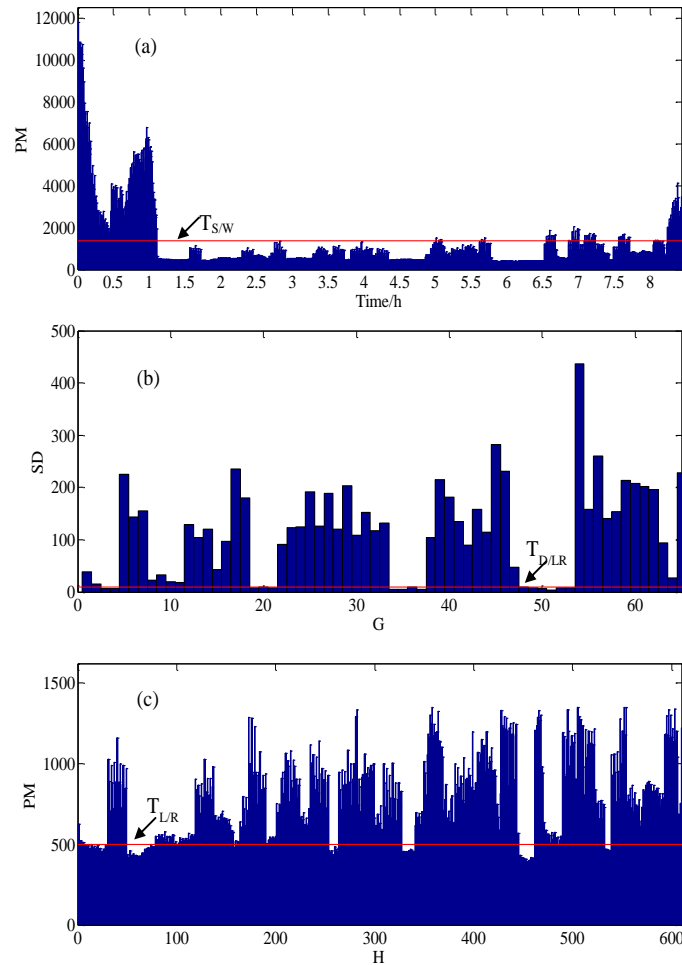

Figure 38. Illustration of three thresholds in sleep stages discrimination.

3.2 Deep sleep and Light sleep/REM discrimination

A lower movement level corresponds to a deeper sleep state [153]. It is possible to define a threshold of PM value or standard deviation of several continuous PM values to discriminate light sleep from deep sleep. REM sleep is shorthand defined as an activated brain in a paralyzed body, but muscle twitches often accompany REM [154]. It can therefore be assumed that the overall movement level during REM is very low, but the standard deviation of movement level may be relatively high due to muscle twitches. Based on the above analysis, we believe that deep sleep is characterized by the lowest standard deviation of movement level, which could be used as a feature to distinguish it from light sleep and REM. Hence, it is possible to define a standard deviation threshold of several continuous PM values to distinguish deep sleep from light sleep and REM. For epochs first classified as ‘Sleep’, 6-epochs groups G are formed (representing 3-minute data). For each G , the standard deviation (SD) of the PM values is calculated. If SD is less than a threshold $T_{D/LR}$ (as illustrated in

Figure 38(b)), the epochs in G are classified as ‘Deep sleep’. The value of $T_{D/LR}$ is 10 derived from testing, observation and correction.

3.3 Light sleep/REM discrimination

Light sleep and REM are characterized by a relatively high and relatively low movement level respectively. Thus, a threshold on the PM value can be used to discriminate between them. After the two previous steps, the remaining epochs noted as H can be classified as ‘Light sleep’ or ‘REM’. To discriminate these two stages, a 500 value threshold T_{LR} is defined (as illustrated in Figure 38(c)), derived from tests, observations and threshold adjustments. When the PM of H is greater than T_{LR} , it will be classified as ‘Light sleep’ otherwise as ‘REM’.

The overall classification procedure is described in Figure 39.

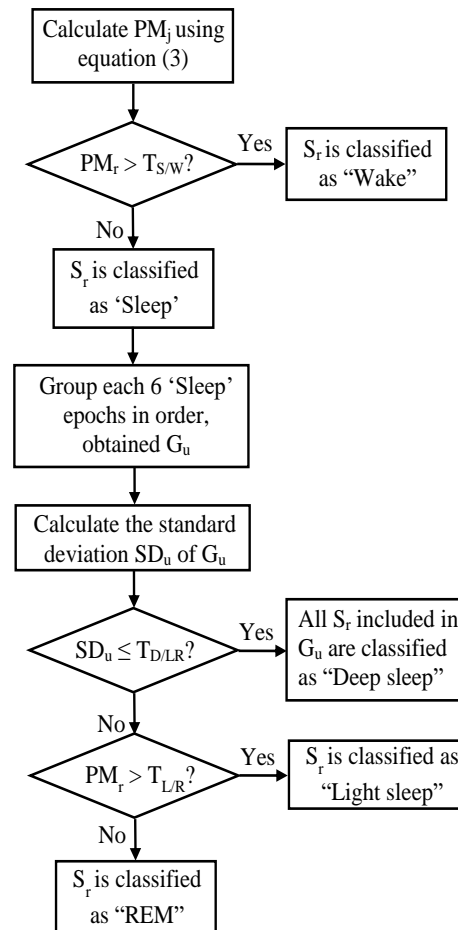

Figure 39. Procedure of sleep stages discrimination.

3.4 Detection of falling asleep and waking up

Based on “sleep” and “awake” detections using the threshold method described above, we have defined a falling asleep point and a waking up point corresponding respectively to the beginning and

end of a night's sleep. Once monitoring begins, if the “sleep” state lasts at least 5 minutes, the first point of the 5 minutes will be considered as the starting point for falling asleep, noted as the asleep point. From the end of the recording and the countdown monitoring, if the “sleep” state lasts at least 5 minutes, it will be considered as the last “sleep” epoch. Thus, the following epoch is considered to be the starting point of awakening, noted as the awakening point. The epochs between the asleep point and the awakening point are defined as the sleep segment.

3.5 Optimization processing

After obtaining the result of the sleep stage classification using the procedure shown in Figure 39, some steps are necessary to optimize the results:

- 1) When the falling asleep point has been determined, all the epochs before it will be considered as “awake”.
- 2) Once the point of awakening has been determined, all subsequent epochs will be considered “awake”.
- 3) When ‘light sleep’ lasts less than 1 minute and there is an “awake” state before and after, define this ‘light sleep’ period so that it is classified as ‘awake’.
- 4) When “REM” lasts less than 1 minute and there is a ‘light sleep’ before and after, define this “REM” period as a ‘light sleep’ one.

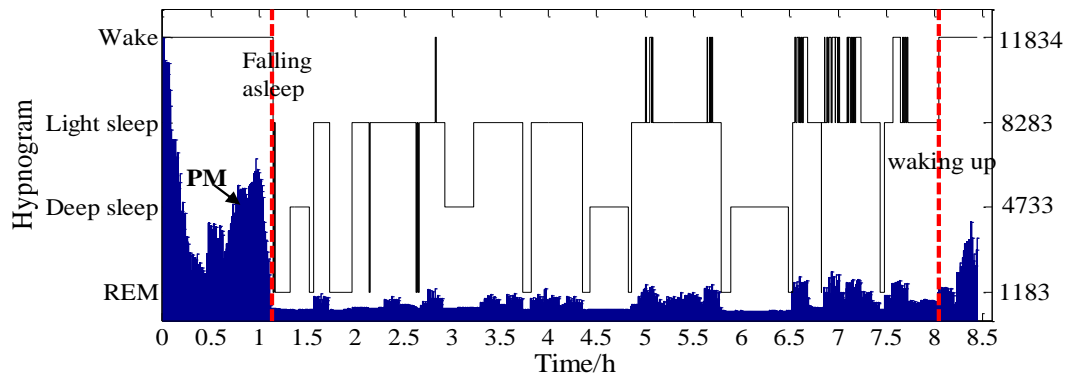

Figure 40. Example of result obtained with the “Threshold method” for a night.

Figure 40 shows a result of the “Threshold method” including the detection of the time of falling asleep, waking up and the hypnogram with the corresponding PM evolution.

The “Threshold method” uses three thresholds which are all absolute values to classify sleep stages. This means that the same thresholds will be applied to different people. It is difficult to make this a universally applicable method because people's movements during sleep are different, the amplitude

and frequency of movements are individual characteristics which can be explained by factors such as body height and weight, gender, physical condition, age, etc. In order to develop a universal method suitable for different people, we plan to test the k-means clustering that makes this possible as explained in section 4.1.

4 K-means method

4.1 K-means clustering

As a classic machine learning method, k-means clustering [155] has been widely used in fields as diverse as image segmentation, data compression, wireless sensor network routing, data mining, etc. It is an efficient method for automatically classifying a dataset into k-groups based on the similarity of the features of each data set. First, it randomly selects k initial cluster centers C_i and then iteratively performs the following steps:

1. Assign each sample s_i to its nearest clustering center;
2. Update each C_i clustering center with the mean of the samples currently in the cluster.

The algorithm converges when the assignment of samples to clusters does not change any more. For the k-means clustering algorithm, the selection of the initial cluster centers could significantly affect the final clustering result. As the initial clustering centers are randomly selected, the clustering result also has some uncertainty. During the experiments, we found that the final clustering results using randomly selected cluster centers generally did not change much, but in a few cases the final clustering results were far from the others. In order to prevent these rare cases from becoming the final clustering result, we repeat the same clustering procedure several times and then determine the final clustering result by voting, as described in the section 4.4.

The k-means method is applied for sleep epochs to obtain a hypnogram containing “Awake”, “Light sleep”, “Deep sleep” and “REM”. The sleep epochs start from the time where we fall asleep until we wake up, which is detected by the threshold method described in section 3. As far as we know, there are several works [156][157][158] that adopt k-means method to classify sleep stages using the EEG signal, but no one using the wrist movement signal.

4.2 Feature extraction

A 2-dimension feature based on PM is used for k-means clustering. We directly use PM as the first dimension of the feature. All PM s are grouped sequentially, and each group contains six PM values. The standard deviation of the PM values in each group is used as the second dimension of the feature

for the corresponding six epochs in the group. In other words, the second dimension of the feature for the six epochs in one group is the same, i.e. the standard deviation of their corresponding PM values.

4.3 Sleep stages clustering

The overall procedure of this “k-means” method consists of 5 iterations of k-means clustering with $k=2$, noted 5km2.

We also tried to classify the four sleep stages directly using only one iteration of the k-means clustering with $k=4$, noted 1km4.

We have adopted “Fitbit charge 2TM” as the reference device to evaluate the results of the “Threshold”, “5km2” and “1km4” methods. The “Fitbit charge 2TM” is a commercial device that has been compared with the PSG (polysomnography) gold standard and validated as promising for sleep stages and sleep-wake detection [159]. The “Fitbit Charge 2TM” has shown a sensitivity of 0.96 (accuracy to detect sleep), a specificity of 0.61 (accuracy to detect wake), an accuracy of 0.81 for the detection of N1+N2 sleep (“light sleep”), an accuracy of 0.49 for the detection of N3 sleep (“deep sleep”), and an accuracy of 0.74 for the detection of rapid-eye-movement (REM) sleep . The classification results of the Fitbit, threshold, 5km2 and 1km4 methods will be presented in section 5.3, and the hypnograms and the proportion of each two-night sleep stage obtained by each method are shown in Figures 41 and 42 respectively. The volunteer for this two-night test is 27 years old with a height of 180 cm and a weight of 60 kg, without sleep complaints.

According to the study [154], for normal young adults who live on a conventional sleep-wake schedule and without sleep disorders:

- Waking up during sleep usually represents less than 5% of the night.
- Light sleep generally accounts for about 47% to 60% of sleep.
- Deep sleep generally accounts for about 13% to 23% of sleep.
- REM sleep usually accounts for 20% to 25% of sleep.

It has been found that the proportion of light sleep should be much higher than that of deep sleep. However, given the experimental results, the 1km4 method still obtains too much deep sleep time and not enough light sleep time, which is contradictory with the results of the study [154] obtained by the PSG method [154]. The 5km2 and threshold methods have comparable results to those of the study [154]. We will therefore present the 5km2 method in detail.

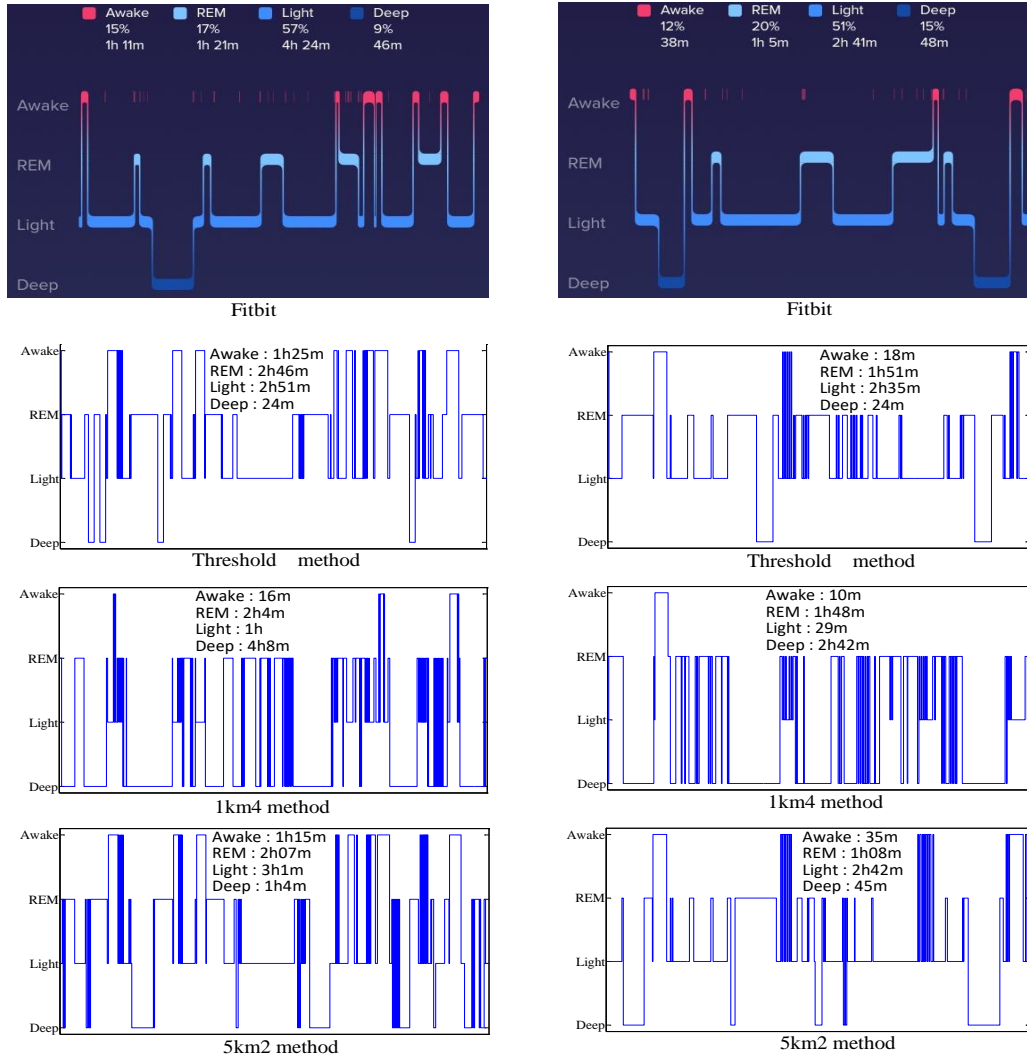

Figure 41. Sleep stages classification result of four methods for two nights.

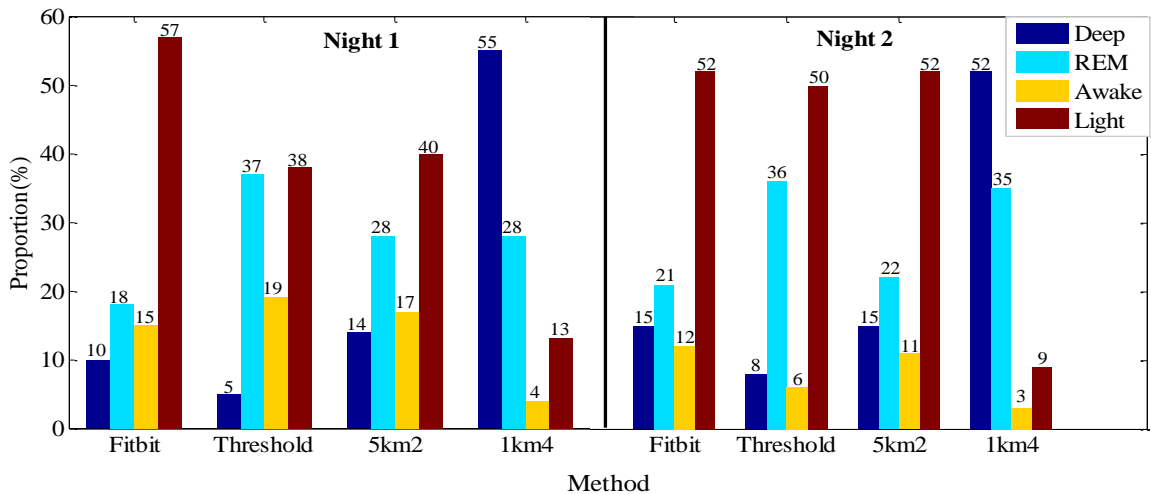

Figure 42. Proportion of each sleep stages obtained from four methods for two nights.

4.3.1 Awake

After a k-means clustering ($k=2$) on the sleep segment defined by the “Threshold” method, the cluster with the highest mean PM value is classified as “awake”. The other cluster is noted as S1.

4.3.2 Light sleep

The “Light sleep” comes from 2 sources. Firstly, after a second k-means ($k=2$) clustering on the previous cluster S1, the cluster with the highest mean value of PM is classified as “Light sleep”. The other cluster is noted S2. Then, a third k-means clustering ($k=2$) is performed on S2, and the cluster with the highest mean PM value is defined as quasi-REM noted S3, the cluster with the lowest mean PM value is defined as quasi-Deep sleep noted S4. Finally a fourth k-means clustering is performed on S3, and the cluster with the highest mean PM value is also classified as “Light sleep”. In summary, “light sleep” corresponds to cluster S2 and the last mentioned cluster.

4.3.3 Deep sleep

On the quasi-Deep sleep cluster noted S4, a new k-means clustering ($k=2$) is carried out. The cluster with the lowest mean PM value is classified as “Deep sleep”.

4.3.4 REM

The “REM”, as “light sleep”, also comes from 2 sources. On the one hand, after a k-means clustering for quasi-REM S3, the cluster with the lowest mean PM value is classified as “REM”. On the other hand, with the k-means clustering performed over quasi-Deep sleep S4, the cluster with the highest mean PM value is also classified as REM.

The procedure for sleep stages clustering is illustrated in Figure 43.

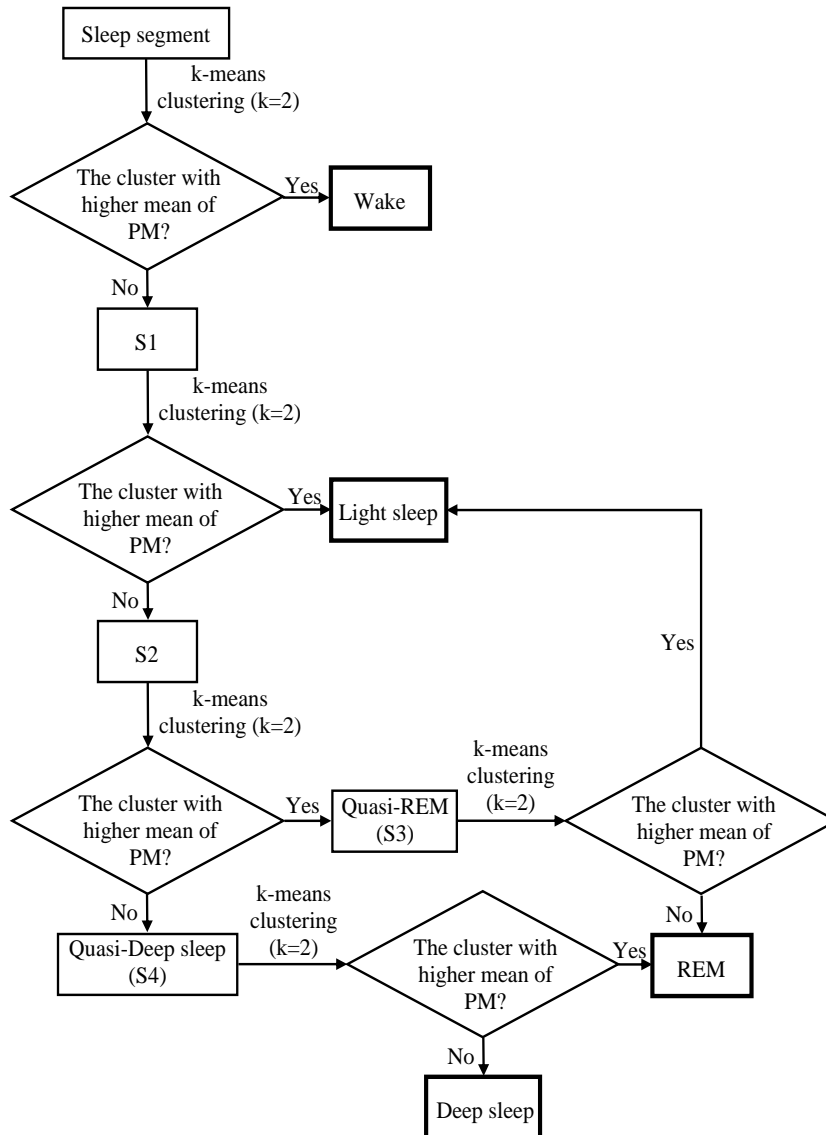

Figure 43. Procedure for sleep stages clustering.

4.4 Voting rule

For k-means clustering, the primary clustering centers are randomly selected, which increases the randomness of the final result. Given our tests, most of the time the final results is the same or very close whatever the randomly selected primary clustering center. However, in a few extreme cases, the final sleep stages distribution will be very abnormal [154]. Table 11 shows the sleep stage results obtained with 10 iterations of the 5km2 method for the same night randomly chosen. As can be seen, the 7th iteration has an abnormal result and is very different from the other 9 iterations. Therefore, 7th iteration could be considered as an extreme case resulting from a randomly selected primary cluster center. To eliminate these extreme cases, a voting rule has been designed.

First of all, we have carried out the above-mentioned sleep stages clustering procedure ten times. Thus, for each epoch, we obtained 10 clustering results. Then, for the 10 clustering results, the class to which the epoch finally belongs is determined by a majority vote. If different classes have the same number of votes, the selection priority is as follows: awake > light sleep > deep sleep > REM.

Table 11. Result of a sleep stage obtained from 10 identical 5km2 methods for one night.

Iteration index	Wake	Light sleep	Deep sleep	REM
1	29.5	134.5	117	187.5
2	29.5	134.5	121.5	183
3	29.5	167	121.5	150.5
4	29.5	167	117	155
5	29.5	131.5	119.5	188
6	29.5	167	121.5	150.5
7	29.5	109	260	70
8	29.5	134.5	117	187.5
9	29.5	134.5	117	187.5
10	29.5	134.5	117	187.5

Unit: minute

5 Experimental results

5.1 Processing time

The “Threshold”, “1km4” and “5km2” algorithms are all implemented on “MATLAB R2011b”, with the same computer with “Intel i7-2600 CPU @ 3.40GHz, 8GB RAM” . For 8-hour night-time data processing, the time spent on the "Threshold method", "1km4 method" and "5km2 method" is 1.04s, 1.73s and 1.84s respectively. The processing time for all algorithms is very short, less than 2 seconds. This indicates that proposed methods can be used in a real time application, giving fast results.

5.2 Falling asleep/waking up detection analysis

5 young adults, from 27 to 32 years old (3 females, 2 males), were recruited for the tests. A total of 15 nights of sleep were tested using four sleep stage classification methods, namely “Fitbit”, “Threshold (the method presented in section 5 which uses 3 thresholds)”, “5km2” and “1km4”. The “Threshold”, “5km2” and “1km4” methods are all implemented solely based on the wrist movement data. Considering every night, we have collected 30 falling asleep/waking up detection results. The difference between the "Fitbit method" and the proposed “Threshold method” for detecting the time of falling asleep and waking up is shown in Table 12.

Table 12 shows that 25 out of 30 results have a maximum time difference of 5 minutes. For night 14, subject 5 reported going to bed around 11.30pm, then watching his smartphone for 10 minutes and then falling asleep. The time of falling asleep detected by the proposed “Threshold method” is

therefore more accurate than Fitbit's for that night. For night 15, the difference in waking time is 49 minutes. However, subject 5 reported waking up around 8:00am that morning. Therefore, the 09:01am wake-up time determined by Fitbit is clearly incorrect. Subject 5 agrees with the wake-up time determined by the “Threshold method” for night 15.

Table 12. Number of sleep and wake-up detection results in different time difference ranges.

Time difference	≤ 5 min	> 5 min ≤ 10 min	> 10 min ≤ 15 min	> 15 min
Number of results	25	2	2	1

5.3 Sleep stages classification analysis

The results of the sleep stage classification are presented in Table 13. They are compared with users' self-reported feedbacks.

Table 13. Comparison of the four methods of sleep stages classification.

Subject	Night	Method	Awake	Light sleep	Deep sleep	REM	Sleep score	Declarative feedback of the subject on his sleep
1(male)	1	Fitbit	71	192	62	86	75.0	Very poor sleep, awake sleep many times
		Threshold	108.5	163.5	18	112	50.0	
		5km2	30	158.5	117.5	97	83.4	
		1km4	14	20	262.5	106.5	73.1	
	2	Fitbit	67	247	74	107	79.5	Very tired before sleeping, sleeps much better than the first night, less sleep awake
		Threshold	66.5	154	66	181	62.9	
		5km2	29.5	134.5	117	187.5	73.7	
		1km4	17.5	32	321.5	97.5	77.3	
	3	Fitbit	59	264	46	81	73.2	Normal sleep
		Threshold	85	169	51	142	63.2	
		5km2	75	181	64	127	71.5	
		1km4	15.5	59.5	248	124	78.4	
2(female)	4	Fitbit	53	184	112	111	84.3	Very light sleep with a distinct awake sleep
		Threshold	12.5	175.5	153	112	91.1	
		5km2	19.5	210	66	175.5	77.5	
		1km4	8.5	16	299.5	147	73.1	
	5	Fitbit	51	262	54	82	77.5	Sleep better than last night (night 4)
		Threshold	41	265	54	81	79.6	
		5km2	116.5	198	54	73.5	63.4	

	6	1km4	25.5	83.5	180	153	74.2	Normal sleep with a sleep awake
		Fitbit	60	236	55	79	76.6	
		Threshold	29.5	95.5	132	151.5	71.4	
		5km2	23	259.5	35	112	77.4	
		1km4	19	59.5	222.5	128.5	76.5	
3(female)	7	Fitbit	15	216	59	90	79.2	Very poor sleep, with a distinct awake sleep
		Threshold	3	95.5	132	151.5	70.5	
		5km2	61.5	146.5	6	169	41.8	
		1km4	18.5	44	240	80.5	71.5	
	8	Fitbit	56	373	61	115	62.4	Sleep much better than last night (night 7)
		Threshold	22.5	287	48	237	55.4	
		5km2	10.5	315	23.5	246.5	48.3	
		1km4	8.5	23.5	360.5	203	58.7	
	9	Fitbit	25	229	31	100	70.3	Normal sleep
		Threshold	11	102	42	225	49.8	
		5km2	10	197	35	139	67.7	
		1km4	9.5	32.5	203	136	65.7	
4(male)	10	Fitbit	38	161	48	65	60.0	Normal sleep
		Threshold	18	155.5	45	89	60.6	
		5km2	34.5	161.5	44.5	67.5	59.4	
		1km4	9.5	29	162	107.5	53.3	
	11	Fitbit	45	199	99	87	87.3	Normal sleep
		Threshold	30.5	243	90	51.5	83.2	
		5km2	136	152.5	94	33.5	57.6	
		1km4	33	76.5	192	114.5	76.3	
	12	Fitbit	59	195	82	79	80.7	Very poor sleep, feeling something unpleasant before going to sleep
		Threshold	32	317.5	30	28	58.5	
		5km2	121	249.5	30	8	45.1	
		1km4	6.5	75.5	169.5	157	73.2	
	13	Fitbit	79	156	92	49	65.0	Very poor sleep, feeling very anxious before going to sleep which affects sleep
		Threshold	23.5	279.5	36	22.5	55.6	
		5km2	126.5	127.5	6.5	102	34.6	
		1km4	45	79	150	88.5	65.8	
5(female)	14	Fitbit	43	272	33	166	66.6	Good sleep, get out of bed around 6:30 then go back to bed continue to sleep
		Threshold	16	280.5	66	132	86.6	
		5km2	10.5	270	136.5	78.5	93.3	
		1km4	7.5	6	334.5	147.5	73.1	
	15	Fitbit	39	379	35	91	64.8	Poor sleep, many dreams and awake during this sleep.
		Threshold	7.5	393	42	51	66.3	

		5km2	135.5	189.5	37.5	132	51.5	Get up around 8:15
		1km4	31	96.5	242	125	80.1	
	16	Fitbit	-	-	-	-		Normal
		Threshold	14.5	381.5	42	153	65.8	
		5km2	141	341	8.5	101.5	31.9	
		1km4	45	111	139.5	296.5	46.3	

(In this table, the unit of number representing the duration of sleep stages is the minute).

On night 2, the volunteer reported having slept well. Comparing the results of the “Fitbit”, “Threshold” and “5km2” methods, the 5km2 classifies less epochs as “Awake” and “Light sleep” and more epochs as “Deep sleep” and “REM”, which is consistent with subject's feedback.

During the fourth night, the volunteer felt that he had slept poorly with very light sleep and a distinctly awake sleep. It can be seen that the k-means method finds more “Light sleep” and less “Deep sleep” than the other two methods, which is more indicative of the subject's true state of sleep.

During night 7, the volunteer had the impression of very little sleep, which is associated with distinct awake sleep. It is noted that the results of the 5km2 k-means method show a much higher proportion of “Awake” and a lower proportion of “Deep sleep”. Compared to the “Fitbit” and “Threshold” methods, the 5km2 method better highlights sleep problems according to the subject's feedback.

During night 8, the volunteer mentioned better sleep compared to the previous night (night 7). On night 8, the results of the k-mean method show a significant decrease in “Awake” and an increase in “Deep sleep” compared to the result of night 7. However, the other two methods even show a significant increase in “Wake” and a near or significant decrease in “Deep sleep”, which may not indicate an improvement in sleep quality.

The test results on nights 1 and 5 show that the k-means method is less effective.

On night 1, the subject reports poor sleep and repeated awakening, but the k-means method gives the least “Wake” and the most “Deep sleep”, which is contrary to the actual sleep state.

On night 5, the subject sleeps better than the previous night (night 4). However on night 5, the k-means method shows a dramatic increase in “Wake” and a slight decrease in “Deep sleep” compared to the night 4, which is also contrary to the actual sleep state.

Nights 3, 6, 9 and 10 are considered by the subjects as normal sleeps. The results of the k-means method are comparable to those of the two other methods for these nights.

On nights 12 and 13, subject 4 reports very poor sleep. For the “5km2” and “Threshold” results, we can see the significant decrease in deep sleep time on nights 12 and 13 compared to nights 10 and 11 which are considered by subject 4 as normal sleep. However, for the “Fitbit” results, the deep sleep time even increases significantly on nights 12 and 13 compared to night 10.

As shown in Table 13, the deep sleep times obtained by “Fitbit”, “Threshold” and “5km2” increased, decreased and decreased respectively between nights 14 and 15. A study [160] has shown that individuals are less awake after the onset of sleep and that people who sleep more deeply report less daytime sleepiness. It can therefore be assumed that being awake is negatively correlated with good sleep and that deep sleep is positively correlated with good sleep. According to the feedback of sleepers, night sleep 14 is good and night sleep 15 is bad. Therefore, the decrease in the duration of deep sleep from night 14 to night 15 may better reflect the real change in sleep quality between these two nights. Considering all nights, 10 nights show better results with the 5km2 method, 4 nights show comparable performance between the 5km2 method, the “Fitbit” and “Threshold” methods, and 2 nights show lower performance for the 5km2 method compared to the “Fitbit” and “Threshold” methods. The test results for nights 2, 4, 7, 8 and 11 - 16 show that the “5km2” method appears to have superior performance in sleep stages classification.

6 Sleep score

After obtaining the hypnogram, we can obtain the duration of each sleep stages, which is closely related to the quality of sleep. It’s therefore possible to assess sleep quality by defining a sleep score based on the hypnogram, which helps users without relevant sleep knowledge to intuitively understand their sleep. For healthy sleep, the total sleep duration and the proportion of each sleep stage should be within a reasonable range. The appropriate sleep duration [161] for individuals of different generation is shown in Table 14.

Table 14. Appropriate sleep duration for each generation.

Generation	Appropriate sleep duration
newborns	14 ~ 17 h
infants	12 ~ 15 h
toddlers	11 ~ 14 h
preschoolers	10 ~ 13 h
school-aged children	9 ~ 11 h
teenagers	8 ~ 10 h
young adults and adults	7 ~ 9 h
older adults	7 ~ 8 h

In this study, all volunteers belong to the young adult and adult generation. The normal proportion of each sleep stage for individuals of this generation who do not complain about their sleep is shown in Table 15 [154].

Table 15. Proportion of normal sleep stages for young adults and adults.

Sleep stage	Normal proportion
Awake	< 5%
Light sleep	47% ~ 60%
Deep sleep	13% ~ 23%
REM	20% ~ 25%

The definition of the symbols is presented in Table 16. These symbols are used in the flowchart for calculating sleep scores.

Table 16. Definition of symbols.

	Awake	Light sleep	Deep sleep	REM
Duration	D_W	D_L	D_D	D_R
Lower limit of normal proportion	P_{WL}	P_{LL}	P_{DL}	P_{RL}
Upper limit of normal proportion	P_{WU}	P_{LU}	P_{DU}	P_{RU}
Total sleep duration	T			
Lower limit of appropriate sleep duration	T_L			
Upper limit of appropriate sleep duration	T_U			
Sleep score	S			

The steps for calculating the sleep score are shown in Figure 44.

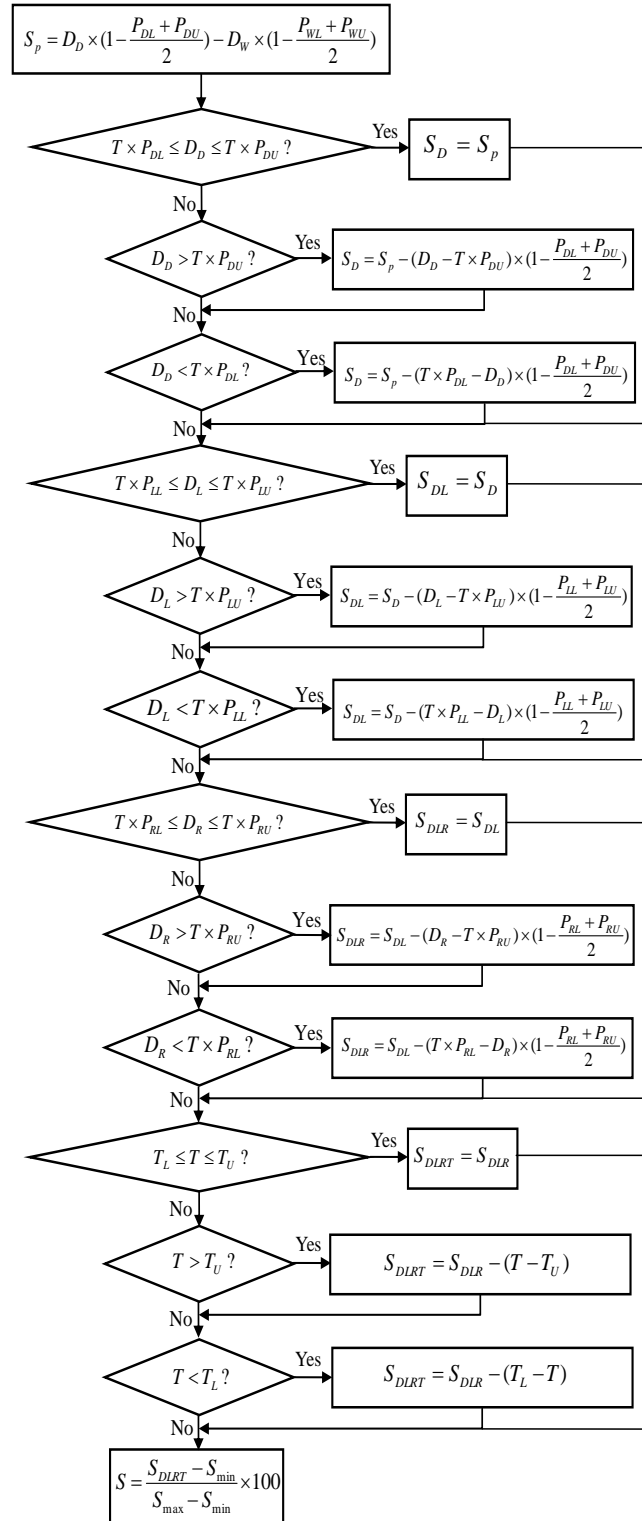

Figure 44. Procedure for calculating the sleep score.

The sleep score is calculated on the basis of the total sleep duration and the duration of each sleep stage. Depending on the normal range given in Tables 14 and 15, any parameter outside the range will result in a lower sleep score. Besides, within the normal range, more deep sleep epochs and less awake sleep epochs will result in a higher sleep score. After obtaining the sleep score, we rescale it

to a range of 0 ~ 100, with the higher score meaning better sleep. The rescaling method is the last step in the diagram in Figure 44.

In order to help the reader better understand the proposed calculation method of sleep score, we take the sleep of night 1 in Table 13 as an example to illustrate the complete sleep score calculation process. On that night, the duration of awake (D_W), light sleep (D_L), deep sleep (D_D) and REM (D_R) is 30, 158.5, 117.5 and 97 minutes respectively, as shown in Table 17.

Table 17. Sleep stage information of the night used to illustrate the calculation of the sleep score.

	Awake	Light sleep	Deep sleep	REM
Duration (Minutes)	30	158.5	117.5	97
Proportion	7.4%	39.3%	29.2%	24.1%
Normal Range	< 5%	47% ~ 60%	13% ~ 23%	20% ~ 25%

According to Table 15, P_{DL} is 0.13, P_{DU} is 0.23, P_{WL} is 0, P_{WU} is 0.05. According to the first step described in Figure 44, we can obtain the primary sleep score S_p from equation (4-4).

$$S_p = D_D \times \left(1 - \frac{P_{DL} + P_{DU}}{2}\right) - D_W \times \left(1 - \frac{P_{WL} + P_{WU}}{2}\right) \quad (4-4)$$

By introducing the value into the equation, we obtain $S_p=67.1$. Then we check if the proportion of deep sleep, light sleep and REM is in the normal range or not.

The proportion of deep sleep is 29.2%. According to Table 4-5, the proportion of deep sleep is too high. This results in a reduction of the score by the equation (4-5).

$$S_D = S_p - (D_D - T \times P_{DU}) \times \left(1 - \frac{P_{DL} + P_{DU}}{2}\right) \quad (4-5)$$

T is the total sleep duration which is the sum of each sleep stage duration. By introducing this value into the equation, we obtain $SD=46.76$.

The proportion of light sleep is 39.3%. According to Table 15, the proportion of light sleep is too low. This results in a reduction of the score by the equation (4-6).

$$S_{DL} = S_D - (T \times P_{LL} - D_L) \times \left(1 - \frac{P_{LL} + P_{LU}}{2}\right) \quad (4-6)$$

According to Table 15, P_{LL} is 0.47, P_{LU} is 0.6. and D_L is 158.5 minutes. By introducing the value into the equation, we obtain $S_{DL}=32.4$.

The proportion of REM is 24.1%. According to Table 15, the proportion of REM is within the normal range. The score will not change at this step:

$$S_{DLR} = S_{DL} \quad (4-7)$$

Finally, we check if the total sleep duration is within the normal range or not. The total sleep duration $T=403$ minutes (6.7h) is not in the normal range for young adults and adults, which should be 7~9h according to Table 14. This will result in a reduction of the score by the equation (4-8).

$$S_{DLRT} = S_{DLR} - (T_L - T) \quad (4-8)$$

According to Table 14, $T_L=420$ minutes (7h). By introducing the values into the equation, $SDLRT=15.4$ is obtained. The $SDLRT$ is the raw sleep score, we rescale the raw sleep score in the range of 0~100 to obtain the final sleep score S . The rescaling is performed by the equation (4-9).

$$S = \frac{S_{DLRT} - S_{\min}}{S_{\max} - S_{\min}} \times 100 \quad (4-9)$$

Where S_{\min} means the raw sleep score of a bad sleep, S_{\max} means the raw sleep score of a very good sleep. We define sleep that lasts only 5 minutes of light sleep as the worst sleep. For the worst sleep, the duration of awake, light sleep, deep sleep and REM is 0, 5, 0 and 0 respectively. We can then calculate the corresponding raw sleep score $S_{\min} = -417.2$. We define the best sleep when the total sleep duration and the proportion of deep sleep are both the upper limit of normal sleep, there is no awake, and the proportions of light sleep and REM are both within the range specified by normal sleep as listed in Table 4-5. For the best sleep, the duration of awake, light sleep, deep sleep and REM is 0, 280.8, 124.2 and 135 minutes respectively. We can then calculate the corresponding raw sleep score $S_{\max} = 101.8$. According to the equation (4-9), we can obtain the final sleep score $S=83.4$. This is the whole procedure of sleep score calculation with the given duration of each sleep stage.

We are trying to find a lower limit for a good sleep score. Here we define a lower limit for a good sleep as a sleep where the lower limit of the total sleep duration, the lower limit of the normal deep sleep proportion, the upper limit of the normal awake proportion, and light sleep, REM are both within the normal range. For the lower limit of good sleep, the duration of awake, light sleep, deep sleep and REM is 21, 252, 54.6 and 92.4 minutes respectively. The corresponding sleep score is defined as the lower limit of the sleep score for good sleep, which is 85.1. The sleep scores calculated for all volunteers on the basis of the hypnogram given by four methods are presented in

Table 13. Of all the 15 test nights, only the sleep score of night 4 with the threshold method, night 11 with the Fitbit method and night 14 with the threshold and 5km2 methods is above the lower limit of the sleep score for good sleep. Thus, according to the method proposed for calculating the sleep score and the good sleep baseline, the rate of good sleep with the Fitbit method is 6.67% (1/15); the rate of good sleep with the Threshold method is 13.3% (2/15); the rate of good sleep with the 5km2 method is 6.67% (1/15). It should be pointed out that the 5 volunteers for the tests are all PhD students. One study showed that only 11.5% of the students surveyed met the criteria for good sleep quality [162]. Thus, the relatively low rate of good sleep obtained by the methods we propose can be considered as a reasonable result.

7 Performance evaluation compared to commercial products

7.1 Reference devices

About one year after completing the experiment described in section 4.5.3, we purchased another commercial sleep monitoring device, “Withings Sleep Analyzer” [163]. We intended to re-test the algorithm in 4.5.3 using the average of the Withings and Fitbit data as a reference to evaluate the results of the proposed methods. We then re-tested subject 4 in Table 13 for 10 nights of sleep and found that the results obtained using the algorithm differed significantly from those of Fitbit and Withings as shown by the results of volunteer 1 in Table 18. Therefore, we decided to modify the algorithm in order to fit the results.

7.2 New “Threshold” method

Compared to the “Threshold” method mentioned in Section 3, the change to the new “Threshold” method only affects the value of $T_{D/LR}$ (threshold used to distinguish deep sleep from light sleep and REM) and $T_{L/R}$ (threshold used to distinguish light sleep from REM). In the new “Threshold” method, the $T_{D/LR}$ value is 49 and the $T_{L/R}$ value is 560, derived from experimental observation and testing. In the following content, the “Threshold” method mentioned in Section 3 is noted as the “T1” method, the new “Threshold” method noted as the “T2” method.

7.3 New “k-means” method

Compared to the “5km2” method mentioned in Section 4, the new “k-means” method uses the same features but the clustering procedure changes. The number of k-means clustering iterations in the new “k-means” method will not only be 5 as in the “5km2” method. An iteration condition is established which may lead to a number of iteration higher than 5. The overall procedure of the new

“k-means” method includes multiple iterations of k-means clustering with $k=2$, noted as “Mkm2” (M stands for Multiple). The detailed steps of “Mkm2” method are presented in Figure 45.

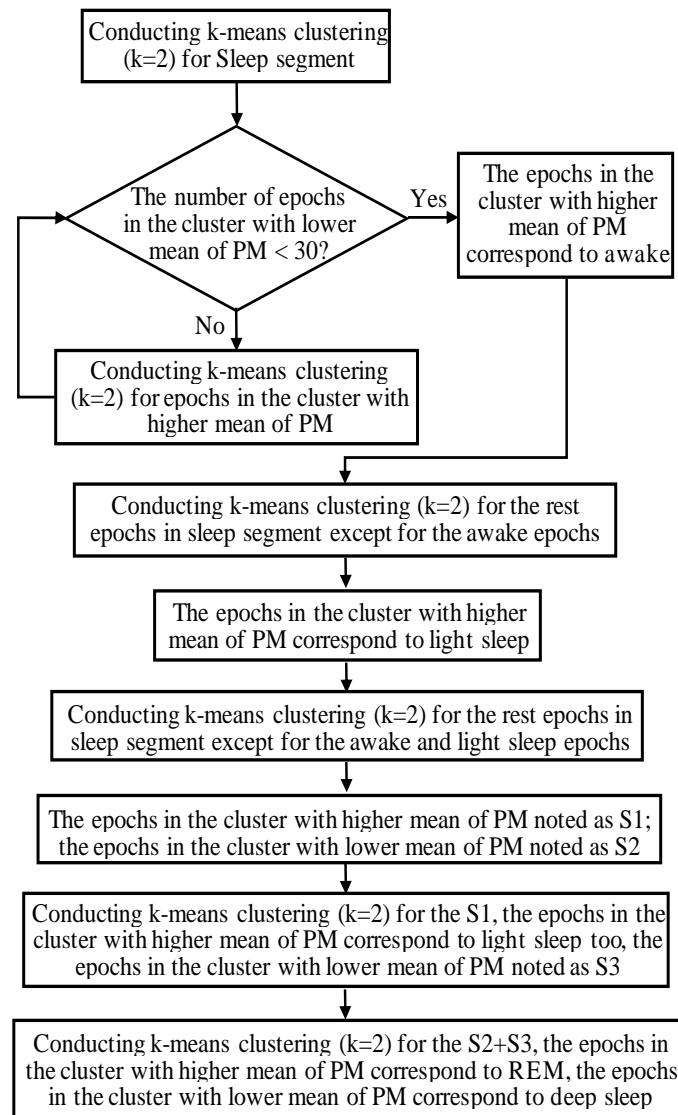

Figure 45. Flow chart of the “Mkm2” method.

7.4 Experimental setup

Two males adult without subjective sleep disorders were recruited as test volunteers. Volunteer 1 is 28 years old and has a BMI (body mass index) of 18.3. Volunteer 2 is 27 years old and has a BMI of 19.1. A total of 17 nights (10 nights for volunteer 1, 7 nights for volunteer 2) of sleep data acquired under real conditions were tested using six sleep stage classification methods: two commercial products including “Fitbit” and “Withings”, four proposed methods including the “T1”, “T2”, “5km2” and “MKm2” methods. The “T1”, “T2”, “5km2” and “MKm2” methods are implemented

solely on the basis of wrist movement data. The proposed algorithms are all implemented on the same computer with “Intel i7-2600 CPU @ 3.40GHz, 8GB RAM” on “MATLAB R2011b”.

7.5 Falling asleep and waking up detection

The detection of falling asleep and waking up is only achieved by the “Threshold” method (T1 and T2, they are the same in the algorithm for detecting falling asleep and waking up). The mean value of “Fitbit” and “Withings” for the moments of falling asleep and waking up is adopted as a reference. Over all nights, the absolute values of the time difference between the “Threshold” method and the reference for the falling asleep time is 13.3 ± 11.4 min, and for the waking up time is 8.6 ± 10.0 min. The 17 nights’ falling asleep and waking up moments obtained by the reference and the “Threshold” method are shown in Figure 46. As can be seen, most of falling asleep and waking up times are close to the reference.

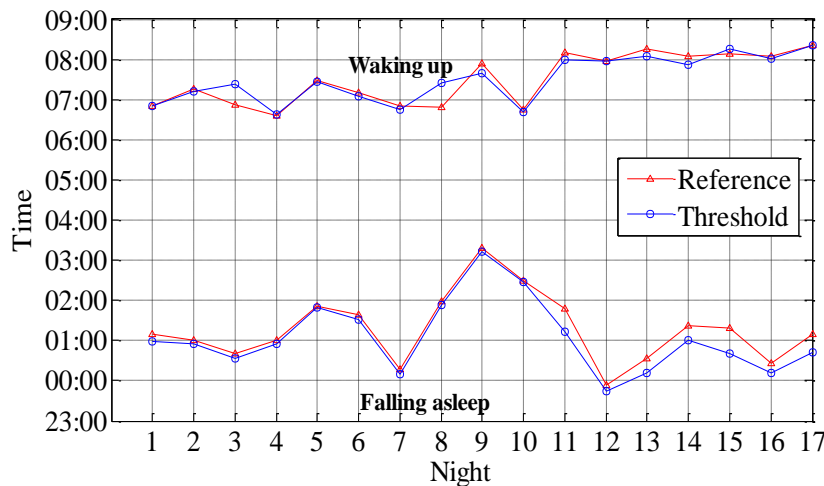

Figure 46. Moments of falling asleep and waking up obtained by reference and “Threshold” method.

7.6 Cumulative duration of each sleep stage

The cumulative duration of each sleep stage is calculated for the “Fitbit”, “Withings”, “T1”, “T2”, “5km2” and “Mkm2” methods. We take as a reference the mean value of the “Fitbit” and “Withings” methods for the cumulative duration of each sleep stage. The results of the comparison of the proposed methods and the reference in the sleep stage classification and the determination of the time of falling asleep and waking up are presented in Table 18. Overall, looking at Table 18, it can be seen that the results obtained by the new method (T2 and Mkm2) are closer to the reference than the old method (T1 and 5km2). The results obtained will then be analyzed to assess the performance of the proposed four methods.

Table 18. Comparison of the results of the proposed methods and the reference.

Volunteer	Night	Method	Awake	Light	Deep	REM	Time of falling asleep	Time of waking up
1	1	Reference	20	198.5	46	77.5	02:09	07:51
		T1	15	231	12	94.5	01:59	07:51
		T2	15	202	48	87.5		
		5km2	140.5	156	12	44		
		Mkm2	17	195.5	53	86		
	Reference	23	209.5	94.5	52.5	02:01		
	2	T1	24	272	54	26.5	01:55	08:12
		T2	24	186.5	114.5	52		
		5km2	81	182.5	18	95		
		Mkm2	11.5	124.5	158.5	81		
		Reference	15	186.5	75.5	96		
	3	T1	26	250.5	48	85	01:34	08:23
		T2	26	204.5	96	83		
		5km2	21	274.5	28.5	85.5		
		Mkm2	7	260.5	67	74		
		Reference	23	161	99	52.5		
	4	T1	14	204	46.5	77	01:56	07:38
		T2	14	183	88.5	55.5		
		5km2	122	122	28.5	68		
		Mkm2	10	167	115	48.5		
		Reference	26.5	217	67	25.5		
	5	T1	70	213.5	48	5.5	02 :49	08 :26
		T2	70	166	72	29		
		5km2	110.5	138	56	32.5		
		Mkm2	6.5	151.5	88	90		
		Reference	17	161.5	84	71		
	6	T1	52	253.5	18	9.5	02 :32	08 :05
		T2	52	206	48	26.5		
		5km2	144.5	116	56	17		
		Mkm2	8	191	88	45		
		Reference	30	225.5	63.5	74		
	7	T1	25	313.5	24	33	01 :10	07 :45
		T2	25	272	54	44.5		
		5km2	136.5	221	17	20		
		Mkm2	6	251	38.5	99		
		Reference	26.5	154	61	48.5		
	8	T1	50	189.5	24	66.5	02 :54	08 :24
		T2	50	142	82.5	55.5		
		5km2	62.5	177	22	67.5		
		Mkm2	5	99.5	120.5	104		
Reference		15.5	162.5	30.5	55	04 :19		
9	T1	11	159	18	78	04 :13	08 :39	
	T2	11	138	30	87			
	5km2	104.5	115	24	21.5			
	Mkm2	14	160.5	34.5	56			
	Reference	18.5	139	64.5	34			03 :29
10	T1	13	136.5	6	98	03 :27	07 :41	
	T2	13	109.5	54	77.5			
	5km2	73	118.5	26.5	35			
	Mkm2	0.5	121	63	68.5			
	Reference	24	209	87	78.5			01 :48
2	1	T1	35	300.5	54	17	01 :13	08 :00
		T2	35	175.5	168	28		

		5km2	88	115.5	9	193		
		Mkm2	14	145	229.5	17		
	2	Reference	17.5	230	120.5	116.5	23 :54	07 :58
		T1	1.5	170	72	250.5	23 :44	07 :58
		T2	1.5	128.5	174	190		
		5km2	166.5	193	83.5	50		
		Mkm2	4.5	258	119.5	111		
	Reference	98	226.5	80	64.5	00 :34		
	3	T1	44	140	42	246	00 :12	08 :04
		T2	44	101	136.5	190.5		
		5km2	26	244.5	44	156.5		
		Mkm2	7	104.5	190	169.5		
		Reference	19	184.5	110	93		
	4	T1	16.5	282.5	66	46.5	01:01	07:52
		T2	16.5	150.5	192	52.5		
		5km2	9.5	111	83	207		
		Mkm2	3.5	9	350.5	47.5		
		Reference	17.5	187.5	109	97.5		
	5	T1	16	279	42	117.5	00:41	08:15
		T2	16	185	174	79.5		
5km2		9.5	194.5	46	203.5			
Mkm2		7.5	146.5	166	133.5			
Reference		76	226.5	80.5	83	00 :27		
6	T1	31.5	154	54	230	00:11	08:01	
	T2	31.5	116.5	168	153.5			
	5km2	28.5	248	62	130			
	Mkm2	14	25.5	308	121			
	Reference	55	153	124.5	85.5			01 :10
7	T1	44.5	215	42	157.5	00 :42	08 :21	
	T2	44.5	145.5	198	71			
	5km2	50	268	18.5	121.5			
	Mkm2	37.5	38.5	286	96			

Table 19 shows the mean±SD of the cumulative duration of each sleep stage obtained by reference, using the “T1”, “T2”, “5km2” and “Mkm2” methods for the two volunteers. To check whether there is a statistically significant difference between the “T1”, “T2”, “5km2”, “Mkm2” methods and the reference with regard to the cumulative duration of each sleep stage, we also calculate the p-values of the Pearson correlation using a Student's t-distribution for a transformation of the correlation. The p-value is the probability of obtaining test results that are at least as extreme as the results actually observed, assuming that the null hypothesis is correct [164]. In general, there is no statistically significant difference when $p > 0.05$ [165].

Table 19. Measures of the cumulative duration of each sleep stage between the reference and the proposed methods.

Volunteer	Time in each sleep stage		Awake	Light	Deep	REM
1	Reference	Mean±SD(min)	21.5±5.1	181.5±29.9	68.6±20.9	58.7±21.2
	T1	Mean±SD(min)	30±20.3	222.3±53.2	29.9±17.5	57.4±35.3
		<i>p</i> -value	0.30	0.29	0.54	0.21
	T2	Mean±SD(min)	30±20.3	181.0±45.5	68.8±26.3	59.8±23.0
		<i>p</i> -value	0.30	0.35	0.52	0.10
	5km2	Mean±SD(min)	99.6±39.9	162.1±52.9	28.9±15.2	48.6±28.4
		<i>p</i> -value	0.46	0.71	0.77	0.97
	Mkm2	Mean±SD(min)	8.6±4.7	172.2±53.4	82.6±39.5	75.2±20.6
		<i>p</i> -value	0.51	0.70	0.47	0.03
	2	Reference	Mean±SD(min)	43.9±32.9	202.4±28.7	101.6±18.8
T1		Mean±SD(min)	27±16.1	220.1±67.3	53.1±12.2	152.1±95.9
		<i>p</i> -value	0.06	0.05	0.24	0.16
T2		Mean±SD(min)	27±16.1	143.2±30.4	172.9±19.9	109.3±67.4
		<i>p</i> -value	0.06	0.04	0.17	0.22
5km2		Mean±SD(min)	54±56.6	196.4±63.2	49.4±29.1	151.6±56.6
		<i>p</i> -value	0.46	0.07	0.69	0.75
Mkm2		Mean±SD(min)	12.6±11.8	103.9±88.2	235.6±83.1	99.4±51.9
		<i>p</i> -value	0.60	0.38	0.74	0.15

As shown in Table 19, only the *p*-value of Mkm2 method in REM for volunteer 1 and T2 method in light sleep for volunteer 2 are less than 0.05 showing a statistically significant difference from the detected cumulative duration of each sleep stage.

Bland-Altman plots were used to show this agreement. As shown in Figure 47 to 50, the number of points outside the range of the dotted line for the “T1”, “T2”, “5km2” and “Mkm2” methods is 3, 3, 1 and 4 respectively. The number of points outside the dotted line means the number of nights outside the 95% agreement limit in the determination of the cumulative duration for one of the sleep stage. Bland-Altman's plots show a good concordance between the four proposed methods and the reference.

In this section, the performance evaluation of the four proposed methods, using the results of two commercial devices as a reference, shows that the performance of the four methods is relatively similar. Therefore, in the next chapter, we will evaluate the performance of the four proposed methods using the PSG gold standard.

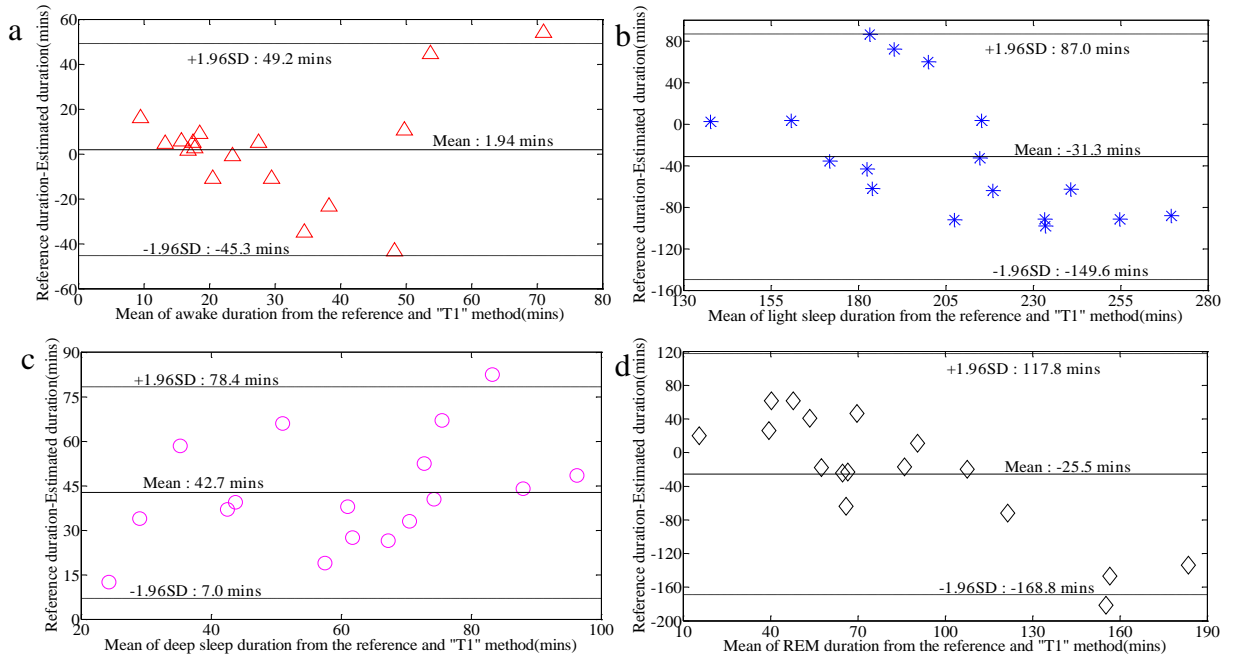

Figure 47. Bland-Altman's plots agreement for four sleep stages determined by the "T1" method. (a) awake; (b) light sleep; (c) deep sleep; (d) REM.

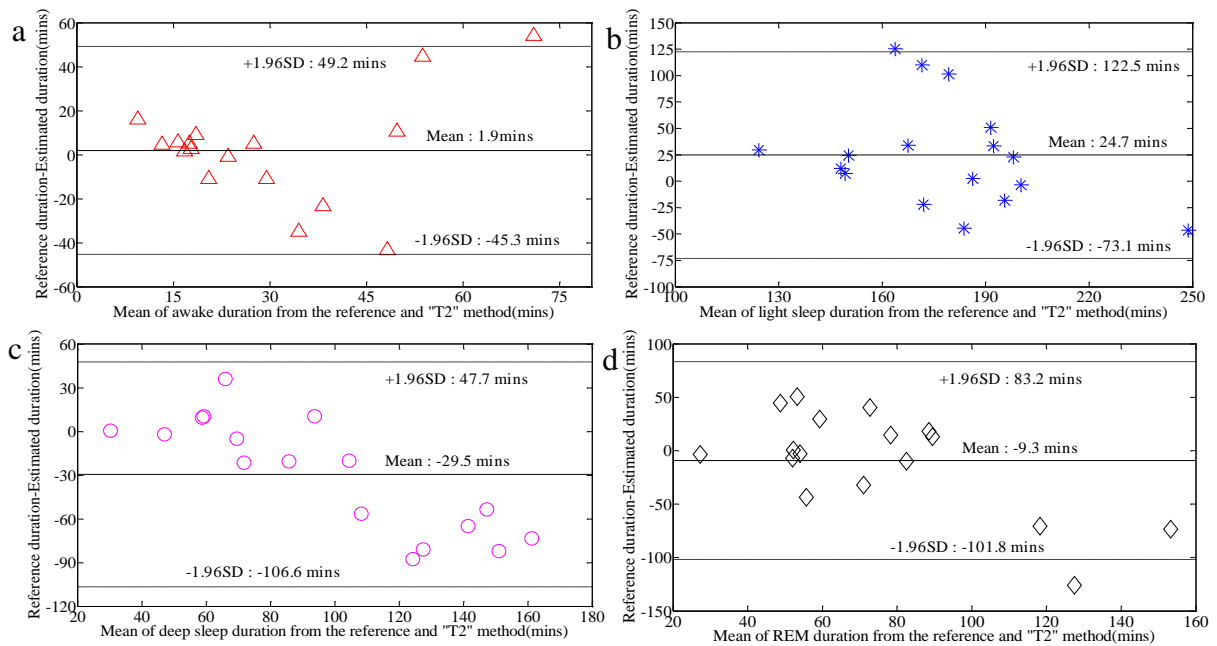

Figure 48. Bland-Altman's plots agreement for four sleep stages determined by the "T2" method. (a) awake; (b) light sleep; (c) deep sleep; (d) REM.

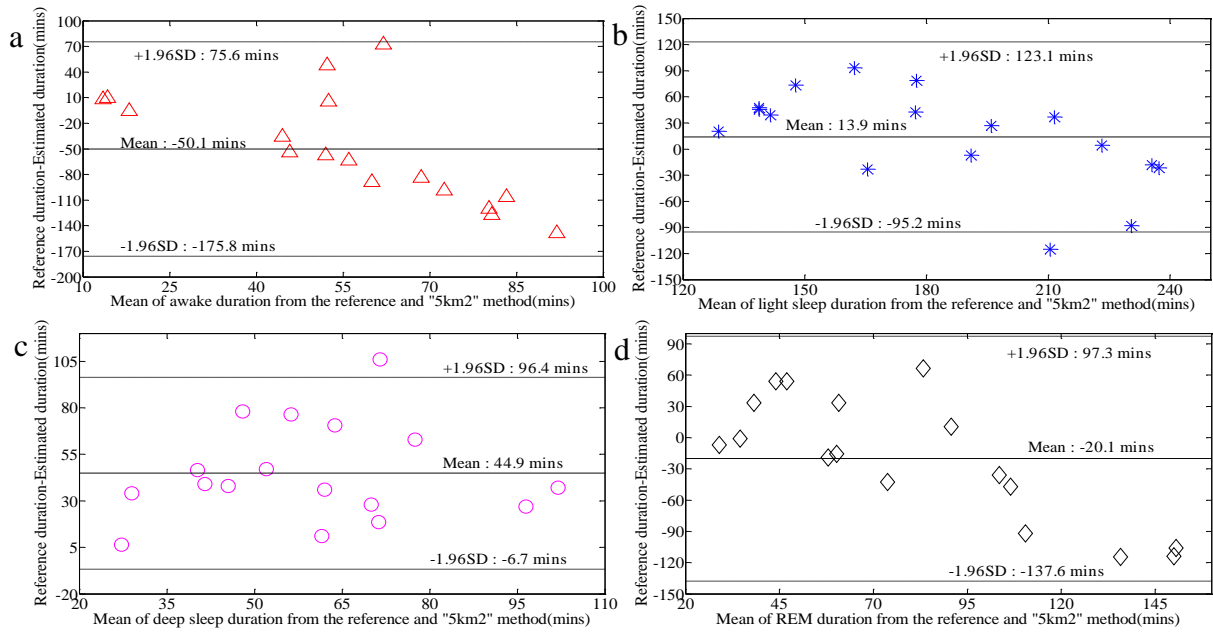

Figure 49. Bland-Altman's plots agreement for four sleep stages determined by the “5km2” method. (a) awake; (b) light sleep; (c) deep sleep; (d) REM.

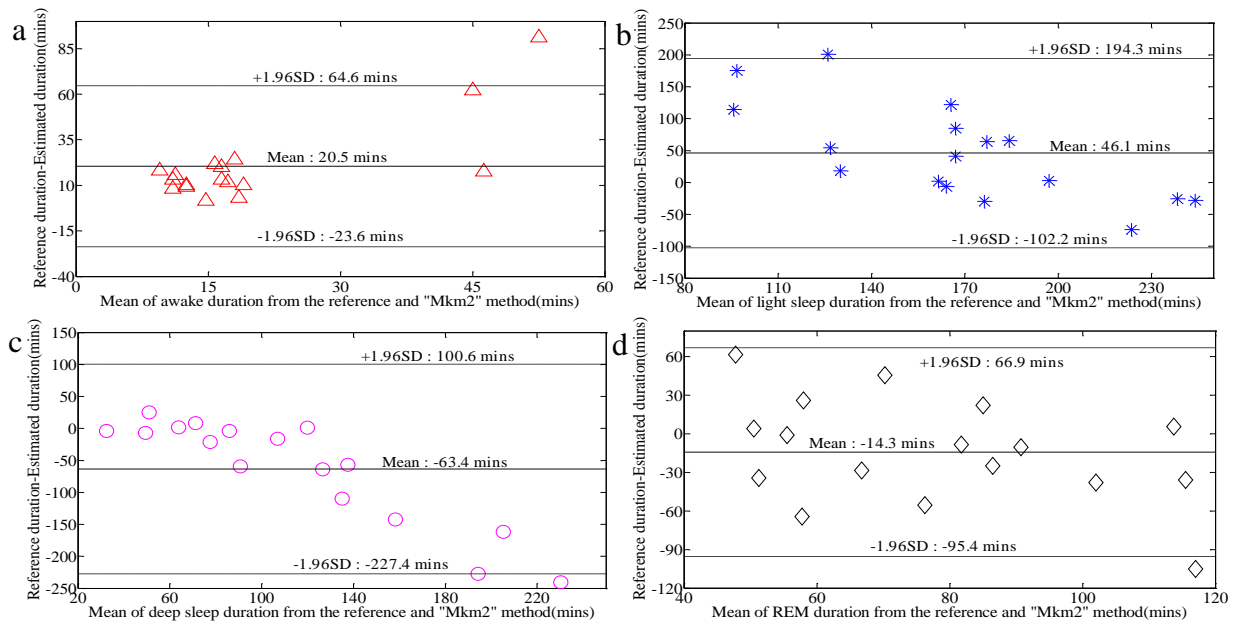

Figure 50. Bland-Altman's plots agreement for four sleep stages determined by the “Mkm2” method. (a) awake; (b) light sleep; (c) deep sleep; (d) REM.

8 Conclusion

In this chapter, we propose algorithms for classifying sleep stages based solely on wrist movements acquired by a worn accelerometer. The proposed algorithms include the threshold-based method (T1 method and T2 method) and the k-means clustering method (5km2 method and Mkm2 method). The threshold-based method uses three thresholds to obtain falling asleep/ waking up detection and sleep stages (“awake”, “light sleep”, “deep sleep” and “REM”) classification. The k-means clustering method allows the classification of sleep stages (“awake”, “light sleep”, “deep sleep” and “REM”) by performing a k-means clustering ($k=2$) 5 (5km2) or multiple (Mkm2) times. We recruited 5 volunteers (2 men, 3 women) who carried out validation tests for 16 full nights. Among the 16 nights, 10 nights show that the “5km2” method is better than the “Fitbit” and the T1 methods, 4 nights show a close performance, only 2 nights show that the “5km2” method is worse. Moreover, we have defined a sleep score calculation method to assess the quality of sleep of a full night. With tests conducted over 16 nights, the sleep score obtained by the method we propose shows a promising performance in determining whether sleep is good or not.

Furthermore, we adopt the mean value of two commercial products “Fitbit” and “Withings” as a reference to validate the four proposed methods. Experimental data are acquired from 17 overnights sleep of two volunteers with no sleep disorder. For the detection of the falling asleep and waking up time, the proposed method shows a deviation of 13.3 ± 11.4 mins and 8.6 ± 10.0 mins respectively from the reference. For the detection of the cumulative duration of each sleep stage a *p-value* is calculated, only the Mkm2 method in REM for volunteer 1 and T2 method in light sleep for volunteer 2 show a statistically significant difference with the reference. Meanwhile, Bland-Altman's plots show that the number of points outside the 95% agreement limit compared to the reference for the “T1”, “T2”, “5km2” and “Mkm2” methods is 3, 3, 1 and 4 respectively. It shows that the four proposed methods are in good agreement with the reference. However, the “Fitbit” and “Withings” are not the gold standard for sleep monitoring, the tests results with the PSG gold standard will be presented and analyzed in the next Chapter.

Chapter 5. Performance evaluation based on the PSG gold standard

1 Introduction

In chapter 4, we have evaluated the performance of our proposed methods by referring to commercial products and obtained good results with the analysis of p-value and Bland-Altman plots. Specifically, only the p-value of the Mkm2 method in REM for volunteer 1 and the T2 method in light sleep for volunteer 2 are less than 0.05, showing a statistically significant difference with respect to the detected cumulative duration of each sleep stage. Besides, the Bland-Altman plots show that the number of points outside the 95% agreement for the “T1”, “T2”, “5km2” and “Mkm2” methods is 3, 3, 1 and 4 respectively (the total number of points is 68, 4 sleep stages in 17 nights). However, commercial products are not the gold standard for sleep monitoring. In the context of rigorous research works, it is essential to use a gold standard to evaluate the performance of the methods we propose. In this way, in this chapter we present our real test in the hospital using the PSG gold standard and we evaluate the methods by comparing them to the PSG results. In addition to evaluating the performance of the wrist module sleep stage classification, we also evaluate the performance of the detection of periodic leg movements during sleep (PLMS) of the foot module with reference to the EMG of the PSG. The correlations between body and skin temperature and sleep have been explored by several studies [110][137]. Besides, the doctors in the hospital cooperating with this project also showed great interest in monitoring skin temperature during sleep to explore the correlations between skin temperature and PLMS. Therefore, to develop hypnogram and PLMS prediction algorithms based on the skin temperature measurement, the links between skin temperature and hypnogram and between skin temperature and PLMS are also studied referring to the results of PSG.

2 Real test in-situ

The PSG is the gold standard in sleep monitoring as it is widely used to evaluate the performance of new sleep monitoring devices. We use the five sleep monitoring modules developed by our research team and the PSG to simultaneously monitor the sleep of a volunteer in the sleep laboratory located in the university hospital center of Toulouse in France to test the four proposed methods.

2.1 Environmental conditions

The test was performed in a sleep laboratory in a standard ward. The environment of the whole ward is shown in Figure 51. The Figure 52(a) shows the volunteer equipped with the PSG system and our five sleep monitoring devices lying on the bed in the ward, ready to be monitored. The corresponding position of the PSG sensors and our modules (chest, wrist and foot module) on the body is illustrated in Figure 52(b). Generally speaking, the time required to wear the modules we proposed is roughly within ten minutes, and it can be done alone. In contrast, it takes about half an hour to install the PSG on the body, and it must be installed by at least one professionally trained medical staff. The volunteer recruited is a 28-year-old man with a BMI (body mass index) of 18.3. A one-night test was carried out for a primary evaluation of the performance of the four proposed methods.



Figure 51. Environment conditions of the whole ward.

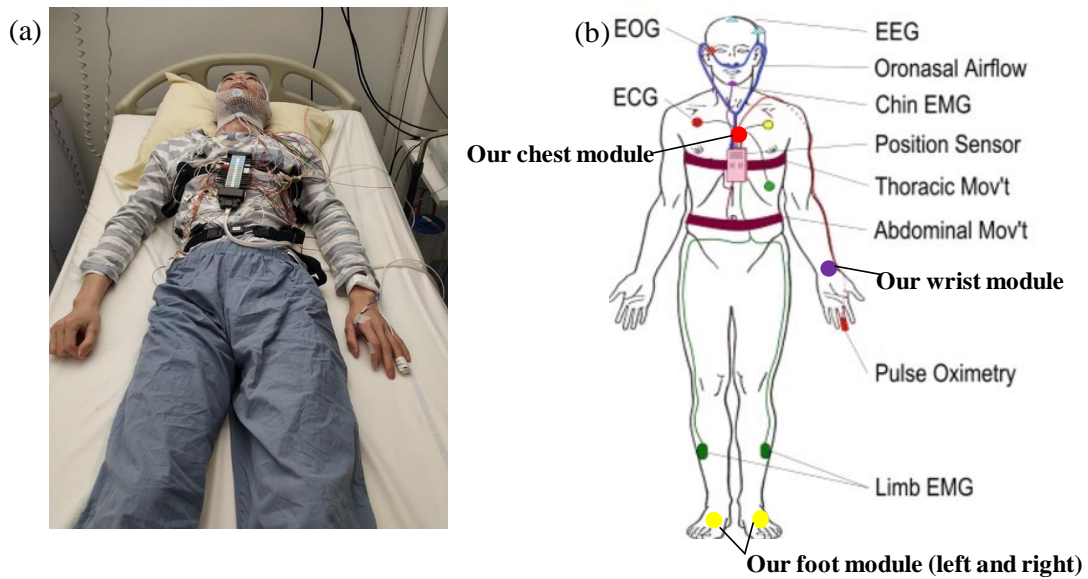

Figure 52. (a) The volunteer with the PSG and our wristband on the body in hospital; (b) Schematic diagram of the corresponding location of the PSG sensors and our modules on the body [169].

2.2 Synchronization protocol

Each of the five sleep monitoring modules and the PSG has their own independent control unit and data acquisition. In practice, it was difficult to ensure that they would all start collecting data at the same time. Therefore, it is essential to synchronize the data collected by all the sleep monitoring devices and the PSG after all data has been collected in order to obtain meaningful results.

The synchronization method we use consists of two steps. First, the five sleep monitoring devices are synchronized with each other. Since each sleep monitoring device has an accelerometer that collects movement data, we intend to synchronize them by shaking them simultaneously and looking for the same marker in the collected movement data. The second step is the synchronization between the five sleep monitoring devices and the PSG. Since all five sleep monitoring devices were synchronized in the first step, it was only necessary to synchronize one of the sleep monitoring devices with the PSG in this step. Since both our foot device and the EMG of the PSG collect leg movement data, we intend to compare the waveforms of the leg movement data collected by the two devices to perform the synchronization between them. The two synchronization steps are described in detail in the following sections.

2.2.1 Synchronization between the five sleep monitoring devices

First, the step is to hold the five sleep monitoring devices together in one hand, as shown in Figure 53, then hold them, without moving, still for 10 seconds, and shake them for 10 seconds. This operation is repeated three times and ends by holding the devices without moving for 10 seconds, as

illustrated in Figure 54. Since all modules will record the movement level, the waveform of the movement level recorded by them will have a shape similar to that in Figure 54.

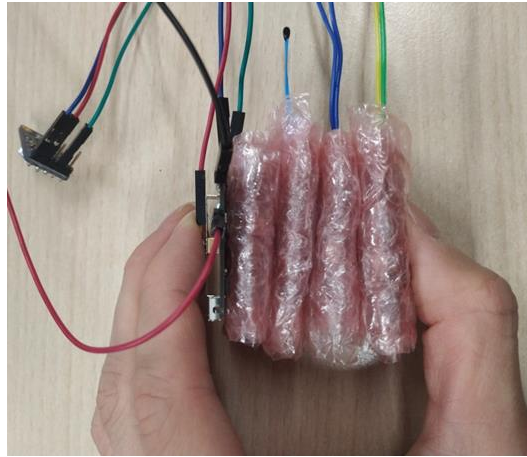

Figure 53. Five hand-held sleep monitoring devices.

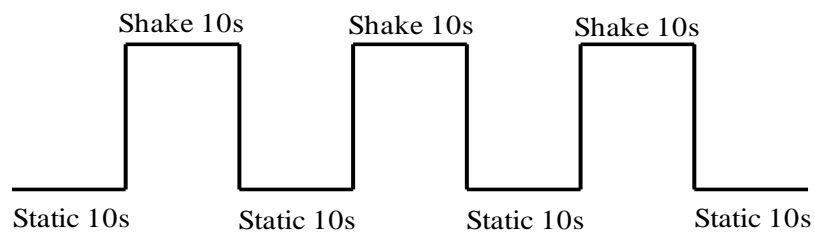

Figure 54. Sequence to create the synchronization sign.

Figure 55 shows the first 4 minutes of the movement level collected by each module. We can easily find the synchronization sign in the waveform of the movement level, as the part noted by the dotted box. The synchronization sign consists of three movement epochs, the edges of each movement epoch can be adopted as a synchronization flag, as indicated by the vertical red dotted line.

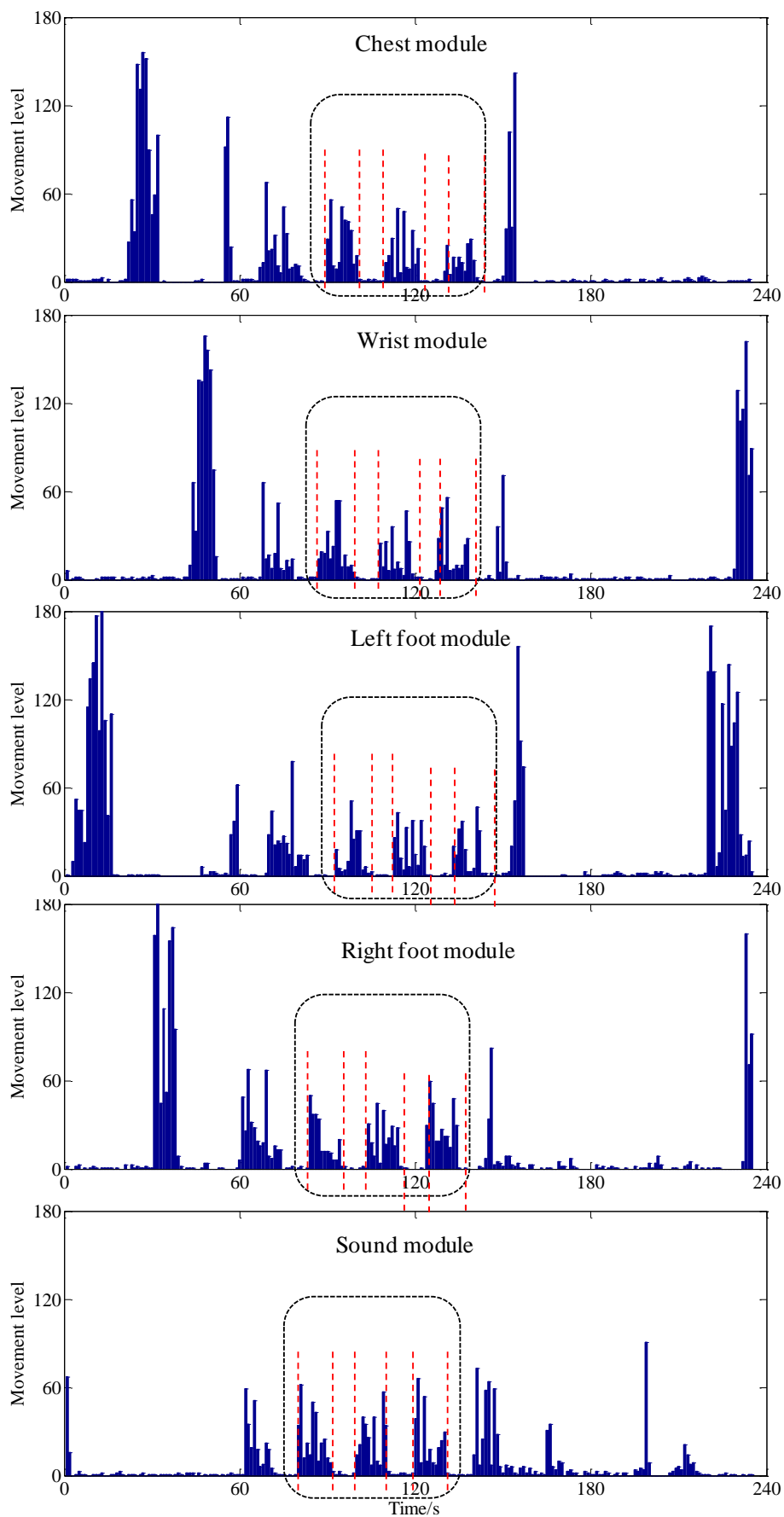

Figure 55. The synchronization sign in the movement level waveform of each module.

2.2.2 Synchronization between the five sleep monitoring devices and the PSG

The PSG records EMG of the legs, whose waveform can be clearly displayed in dedicated software. The foot devices record the movement level of both feet. Here, the PSG and the devices are synchronized by comparing the EMG waveform of the left leg and the movement level waveform of the left foot. The left leg EMG waveform and the left foot movement level waveform should be similar in terms of the change pattern. As shown in Figure 56, the green waveform corresponding to “JAMBG” channel in the upper part of the figure is the left leg EMG waveform recorded by the PSG, the lower part of the figure is the left foot movement level waveform. As we can see, their waveform trends fit perfectly to each other, allowing them to synchronize with each other.

The PSG recording starts at 22:48:46, 06 March, and ends at 03:59:50, 07 March.

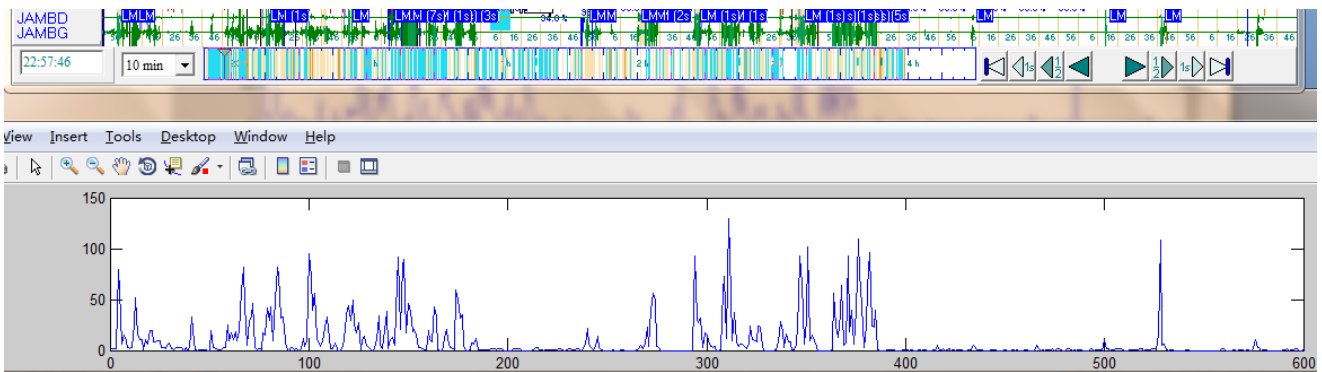

Figure 56. Synchronization sign between PSG and left foot module.

3 Sleep stages classification performance compared to the PSG

3.1 Hypnogram data preparation

We compare the hypnograms obtained by the T1, T2, 5km2 and Mkm2 methods with the hypnogram obtained by the PSG as shown in Figure 57. The hypnogram data of the methods we propose are obtained directly by operating the algorithms on Matlab by programming. The hypnogram of the PSG is read by the software “DeltaFree EEG reader”. The interface of the software after reading the PSG data is shown in Figure 58. The interface shows only the waveforms of each PSG signal and does not directly display the sleep structure diagram. To display the hypnogram, we need to click on button 1 as illustrated on Figure 58.

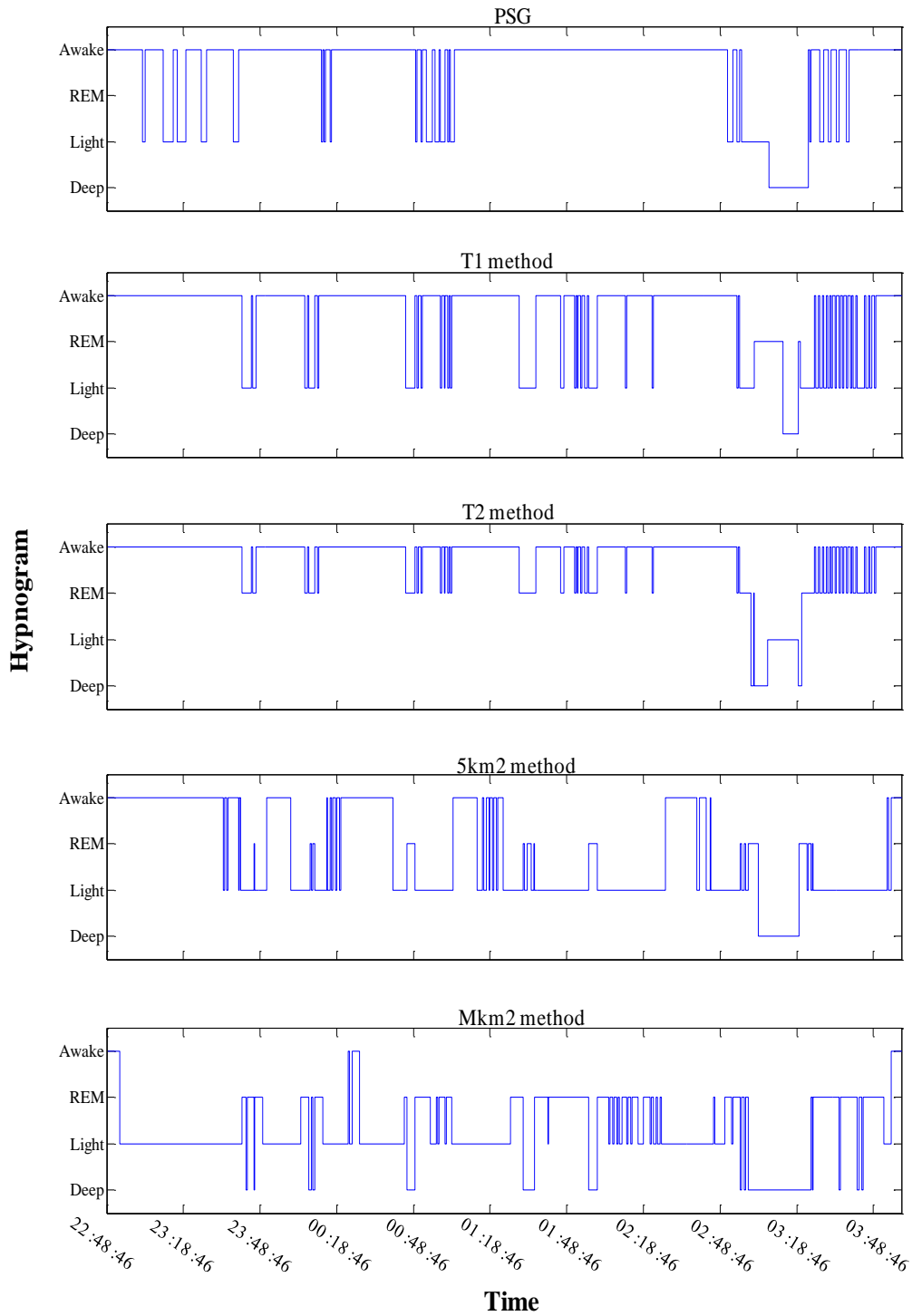

Figure 57. Hypnogram obtained from the PSG, Threshold and 5km2 methods.

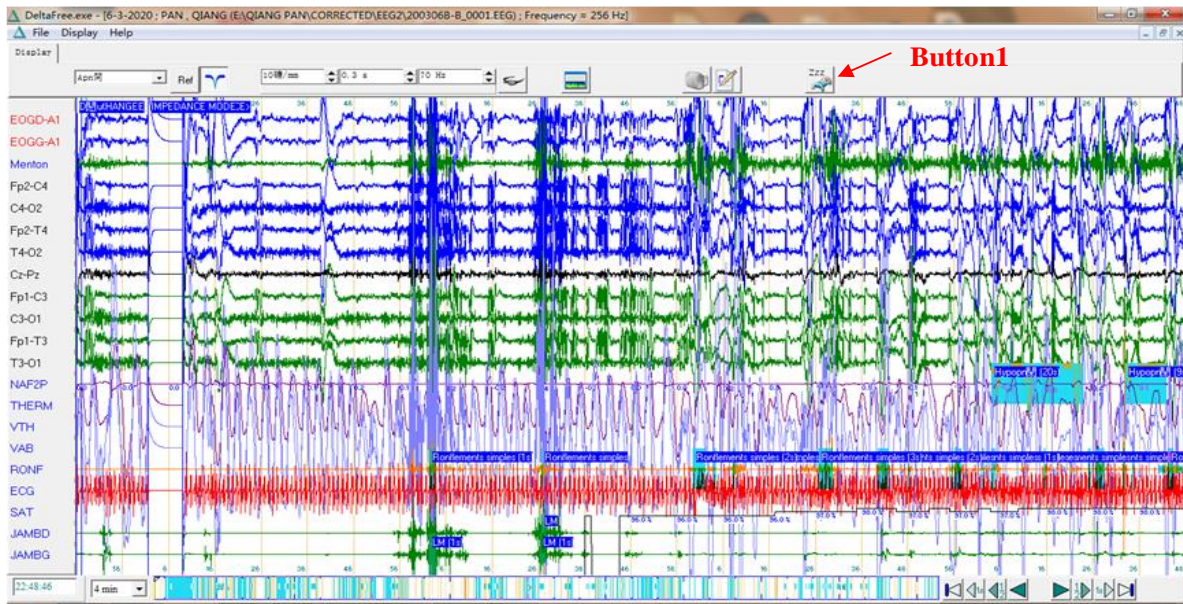

Figure 58. “DeltaFree EEG reader” software interface.

Then, the hypnogram of the whole night will be displayed in the lower part of the interface, as the area 1 marked in Figure 59. The current epoch of hypnogram displayed in the interface is marked by a black vertical line by the software, and area 2 displays the corresponding time of the current epoch of the hypnogram, area 3 displays the corresponding sleep stage of the current epoch of the hypnogram. Once the sleep stage information for the current epoch has been noted manually, the next epoch is displayed by clicking button 2. Thus, by continuously clicking on button 2, we can record the sleep stages for each epoch, one by one, until we have recorded the whole night's sleep stages, i.e. the hypnogram. It is important to note that the software can automatically generate an initial hypnogram and various events based on the data collected by the PSG. However, the initial hypnogram and the different events automatically generated by the software are not completely accurate and must be checked and corrected manually by the physician before to be used as final sleep monitoring results. Of course, the hypnogram given by the software we use in this work has been checked and corrected by the physician.

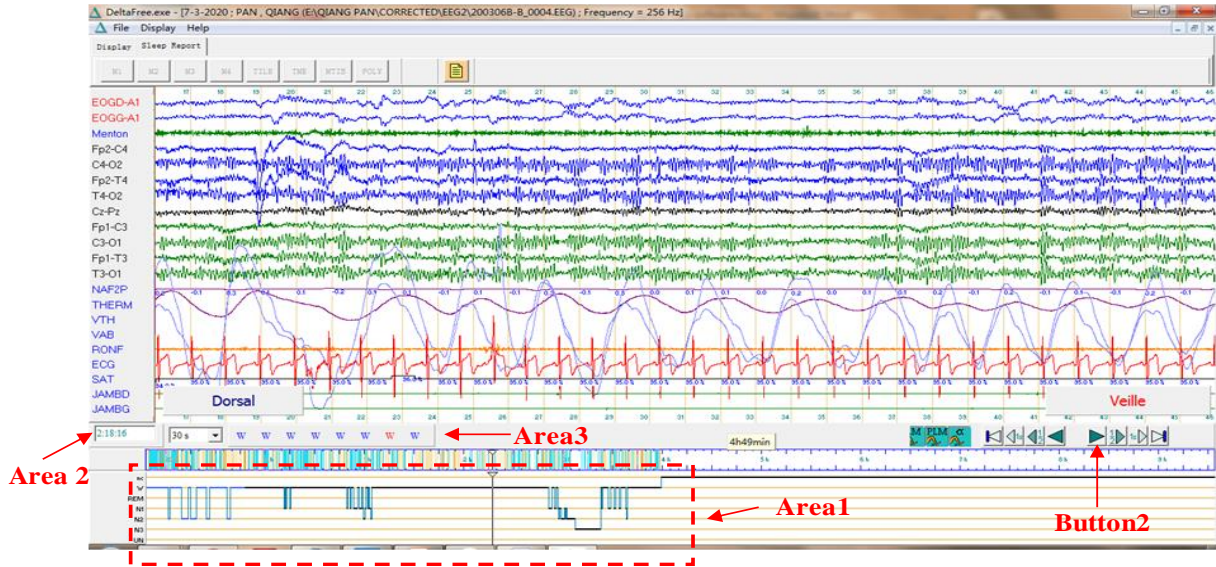

Figure 59. Illustration of obtaining a hypnogram of PSG from the “DeltaFree EEG reader” software.

3.2 Results analysis

Table 20 shows the duration of each sleep stage obtained by the PSG, the T1, T2, 5km2 and Mkm2 methods. Figure 60 shows the proportion of each sleep stage obtained by the PSG, the T1, T2, 5km2 and Mkm2 methods.

Table 20. Cumulative duration (in min) of each sleep stage obtained from the PSG, threshold and 5km2 methods.

	Awake	Light sleep	Deep sleep	REM
PSG	254 (82%)	41.5 (13%)	15.5 (5%)	0 (0%)
T1 method	237 (76%)	56 (18%)	6 (2%)	12 (4%)
T2 method	237 (76%)	12 (4%)	7.5 (2%)	54.5 (18%)
5km2 method	119 (38%)	155.5 (50%)	16 (5%)	20.5 (7%)
Mkm2 method	12.5 (4%)	154.5 (50%)	42 (14%)	102 (33%)

Unit: minute

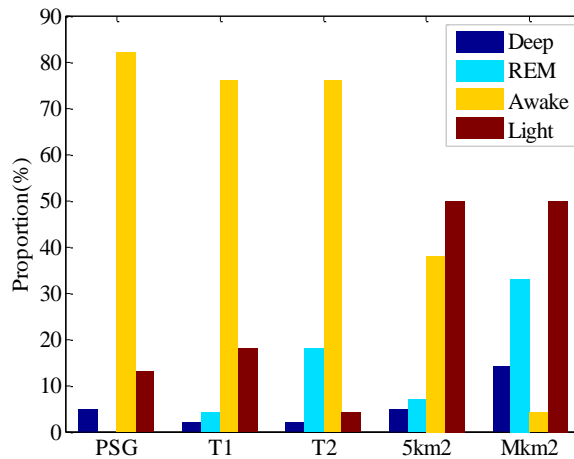

Figure 60. Proportion of each sleep stage obtained from the PSG, threshold and 5km2 methods.

By observing the PSG hypnogram in Figure 57, we can see that the sleep this night consists mainly of awake and light sleep. This result is similar to that of the T1 method and the 5km2 method. These two methods give a hypnogram consisting mainly of awake and light sleep. However, the T2 method gives a hypnogram composed mainly of awake and REM, Mkm2 also gives a much higher proportion of REM compared to the PSG method. This suggests that the T1 and 5km2 methods are better than the T2 and Mkm2 methods. According to Table 21 and Figure 60, the difference is that the hypnogram of the T1 method contains relatively more awake (76%) which is closer to that detected by the PSG (82%) method, the hypnogram of the 5km2 method contains relatively less awake (38%) but more light sleep (50%). In the PSG hypnogram, the longest duration of deep sleep is around 03:18:46. The T1, T2, 5km2 and Mkm2 methods also detected deep sleep at this time, but the proportion of deep sleep detected by the 5km2 method (5%) is the same as that detected by the PSG method (5%). The PSG did not detect any REM epochs but the T1, T2, 5km2 and Mkm2 methods detected a few REM epochs. However, the cumulative duration of the REM detected by the T1 method and the 5km2 method is relatively short, 12 minutes and 20.5 minutes respectively. On the other hand, the cumulative duration of the REM detected by the T2 method and the Mkm2 method is much longer, 54.5 minutes and 102 minutes respectively. In this respect, the T1 and 5km2 methods are slightly better than the T2 and Mkm2 methods.

Readers may be puzzled by this result. As the T2 and Mkm2 methods were developed after the T1 and 5km2 methods were proposed, they were expected to achieve better performance. But why was the performance verified to be inferior to that of T1 and 5km2? This is because the T2 and Mkm2 methods are developed when commercial products are used as a reference. Since this section validates the performance of the T2 and Mkm2 methods against the PSG gold standard, it is possible

to overturn the conclusions previously reached using commercial products as a reference. This also reveals the importance of the choice of reference. By using commercial products as a reference, it is likely that a conclusion totally opposite to that obtained using the PSG as a reference. Readers may again ask themselves, "Are commercial products reliable?" They have already been compared to the PSG in the literature. It is true that some commercial products such as Fitbit have been validated by the PSG. However, the results of the literature show that the commercial product does not perfectly match the PSG results. For the Fitbit, it showed a sensitivity of 0.96 (accuracy to detect sleep), a specificity of 0.61 (accuracy to detect wake), an accuracy of 0.81 for the detection of N1+N2 sleep ("light sleep"), an accuracy of only 0.49 for the detection of N3 sleep ("deep sleep"), and an accuracy of 0.74 for the detection of rapid-eye-movement (REM) sleep. Therefore, the PSG should ultimately be used as a reference to assess the performance of the proposed methods when conditions permit.

So, we have compared the results of the sleep stage classification of the four proposed methods with the PSG, epoch by epoch. Four confusion matrices are created to show the result, as illustrated in Figure 61. For physiological significance, deep sleep is very different from awake and light sleep. Therefore, confusion between deep sleep and awake, and confusion between deep sleep and light sleep can be considered a serious mistake. Unlike the T1 and 5km2 methods, which classify only a small portion of awake or light sleep epochs as deep sleep or REM epochs, the T2 and Mkm2 methods misclassify many more awake or light sleep epochs as deep sleep or REM epochs. This suggests that the T1 and 5km2 methods have better performance in sleep stage classification than the T2 and Mkm2 methods.

		Predicted (T1 method)			
		Awake	Light	Deep	REM
True (PSG)	Awake	423	85	0	0
	Light	51	21	0	11
	Deep	0	6	12	13
	REM	0	0	0	0

		Predicted (5km2 method)			
		Awake	Light	Deep	REM
True (PSG)	Awake	211	272	0	25
	Light	27	38	8	10
	Deep	0	1	24	6
	REM	0	0	0	0

		Predicted (T2 method)			
		Awake	Light	Deep	REM
True (PSG)	Awake	423	0	0	85
	Light	51	1	12	19
	Deep	0	23	3	5
	REM	0	0	0	0

		Predicted (Mkm2 method)			
		Awake	Light	Deep	REM
True (PSG)	Awake	25	275	35	173
	Light	0	34	18	31
	Deep	0	0	31	0
	REM	0	0	0	0

Figure 61. Confusion matrix of the four methods proposed.

Cohen's Kappa coefficient (κ) is a measure of agreement between categorical variables [167]. To evaluate more precisely the agreement between the four proposed methods and the classification of sleep stages using the PSG method, Cohen's Kappa coefficient (κ) is calculated. Landis & Koch [166] characterized $\kappa < 0$ as indicating no agreement and 0–0.20 as slight, 0.21–0.40 as fair, 0.41–0.60 as moderate, 0.61–0.80 as substantial, and 0.81–1 as almost perfect agreement [166]. The T1 method shows a fair agreement with the PSG ($\kappa = 0.24$), the T2 method shows a slight agreement with the PSG ($\kappa = 0.15$), the 5km2 method shows a slight agreement with the PSG ($\kappa = 0.09$) and the Mkm2 method also shows a slight agreement with the PSG ($\kappa = 0.07$), as shown in Table 21.

Table 21. Cohen's Kappa coefficient (κ) of the four proposed methods relative to the PSG.

Method	Cohen's Kappa coefficient (κ)	Agreement with the PSG
T1	0.24	Fair
T2	0.15	Slight
5km2	0.09	Slight
Mkm2	0.07	Slight

Based on the Cohen's Kappa coefficient values of the four methods proposed in Table 21, the T1 method shows the best agreement with the PSG.

For physiological significance, deep sleep is very different from awake and light sleep. Therefore, confusion between deep sleep and awake, and confusion between deep sleep and light sleep in the results of the T2 and Mkm2 methods can be considered a serious error.

		True (PSG)	
		Awake	Not awake
Predicted (T1 method)	Awake	TP=423	FP=51
	Not awake	FN=85	TN=63

		True (PSG)	
		Light	Not Light
Predicted (T1 method)	Light	TP=21	FP=91
	Not Light	FN=62	TN=448

		True (PSG)	
		REM	Not REM
Predicted (T1 method)	REM	TP=0	FP=24
	Not REM	FN=0	TN=598

		True (PSG)	
		Deep	Not Deep
Predicted (T1 method)	Deep	TP=12	FP=0
	Not Deep	FN=19	TN=591

Figure 62. Confusion matrix for the recognition of each sleep stage with the T1 method.

		True (PSG)	
		Awake	Not Awake
Predicted (T2 method)	Awake	TP=423	FP=51
	Not Awake	FN=85	TN=63

		True (PSG)	
		Light	Not Light
Predicted (T2 method)	Light	TP=1	FP=23
	Not Light	FN=82	TN=516

		True (PSG)	
		REM	Not REM
Predicted (T2 method)	REM	TP=0	FP=109
	Not REM	FN=0	TN=513

		True (PSG)	
		Deep	Not Deep
Predicted (T2 method)	Deep	TP=3	FP=12
	Not Deep	FN=28	TN=579

Figure 63. Confusion matrix for the recognition of each sleep stage with the T2 method.

		True (PSG)	
		Awake	Not awake
Predicted (5km2 method)	Awake	TP=211	FP=27
	Not awake	FN=297	TN=87

		True (PSG)	
		Light	Not Light
Predicted (5km2 method)	Light	TP=38	FP=273
	Not Light	FN=45	TN=266

		True (PSG)	
		REM	Not REM
Predicted (5km2 method)	REM	TP=0	FP=41
	Not REM	FN=0	TN=581

		True (PSG)	
		Deep	Not Deep
Predicted (5km2 method)	Deep	TP=24	FP=8
	Not Deep	FN=7	TN=583

Figure 64. Confusion matrix for the recognition of each sleep stage with the 5km2 method.

		True (PSG)	
		Awake	Not Awake
Predicted (Mkm2 method)	Awake	TP=25	FP=0
	Not Awake	FN=483	TN=114

		True (PSG)	
		Light	Not Light
Predicted (Mkm2 method)	Light	TP=34	FP=275
	Not Light	FN=49	TN=264

		True (PSG)	
		REM	Not REM
Predicted (Mkm2 method)	REM	TP=0	FP=204
	Not REM	FN=0	TN=418

		True (PSG)	
		Deep	Not Deep
Predicted (Mkm2 method)	Deep	TP=31	FP=53
	Not Deep	FN=0	TN=538

Figure 65. Confusion matrix for the recognition of each sleep stage with the Mkm2 method.

The confusion matrix for the recognition of each sleep stage with the T1, T2, 5km2 and Mkm2 methods are presented respectively in Figures 62, 63, 64 and 65. Six performance assessment indexes based on the confusion matrix are calculated and presented in Table 22, including:

- Sensitivity: measures the proportion of positives that are correctly identified (i.e. the proportion of those with a certain condition (affected) who are correctly identified as having the condition).
- Specificity: measures the proportion of negatives that are correctly identified (i.e. the proportion of those who do not have the condition (unaffected) who are correctly identified as not having the condition).
- Accuracy: the ratio of correctly predicted samples to the total number of samples.
- Precision: also called PPV (positive predictive value) is the ratio of correctly predicted positives to the total predicted positives.
- Balanced accuracy: the average of the accuracy of each class.
- F1 score: the harmonic mean of the precision and recall (sensitivity), can be used as a single measure of test performance for the positive class.

These indexes assess performance from different perspectives. They all range from 0 to 1, and a higher value means better performance. The equations to calculate them are also listed in Table 22. In our experiments, the number of samples included in the different classes is uneven and usually varies greatly. At the same time, we consider the correct detection of positive and negative samples should be of the same importance. Therefore, among all the performance assessment indexes, we believe that balanced accuracy is the best one to evaluate the overall performance of the proposed methods. As can be seen from the Table 22, the T1 method has the highest or tied for the highest balanced accuracy in each class. As the results, it can be considered that T1 method outperforms than other three methods.

Table 22. Assessment indexes for recognition of each sleep stage with the threshold and 5km2 methods.

Evaluation indexes	Method	Awake	REM	Light	Deep
$\text{Sensitivity} = \frac{TP}{TP + FN}$	T1	0.83	0	0.25	0.39
	T2	0.83	0	0.01	0.10
	5km2	0.42	0	0.46	0.77
	Mkm2	0.05	0	0.41	1.00
$\text{Specificity} = \frac{TN}{FP + TN}$	T1	0.55	0.96	0.83	1.00
	T2	0.55	0.82	0.96	0.98
	5km2	0.76	0.93	0.49	0.99
	Mkm2	1.00	0.67	0.49	0.91
$\text{Accuracy} = \frac{TP + TN}{TP + FP + TN + FN}$	T1	0.78	0.96	0.75	0.97
	T2	0.78	0.82	0.83	0.94
	5km2	0.48	0.93	0.49	0.98
	Mkm2	0.22	0.67	0.48	0.91
$\text{Precision} = \frac{TP}{TP + FP}$	T1	0.89	0	0.19	1.00
	T2	0.89	0	0.04	0.20
	5km2	0.89	0	0.12	0.75
	Mkm2	1.00	0	0.11	0.37
$\text{Balanced accuracy} = \left(\frac{TP}{TP + FP} + \frac{TN}{TN + FN} \right) / 2$	T1	0.66	0.50	0.53	0.98
	T2	0.66	0.50	0.45	0.58
	5km2	0.56	0.50	0.49	0.87
	Mkm2	0.60	0.50	0.48	0.68
$\text{F1score} = \frac{2 \cdot \text{precision} \cdot \text{sensitivity}}{\text{precision} + \text{sensitivity}}$	T1	0.86	0	0.22	0.56
	T2	0.86	0	0.02	0.13
	5km2	0.57	0	0.19	0.76
	Mkm2	0.09	0	0.17	0.54

4 PLMS detection performance compared to the PSG

4.1 Introduction

Restless legs syndrome (RLS) is a neurological condition characterized by an urge to move usually associated with paresthesia that occurs or worsens at rest and is relieved by activity [168]. Most patients with RLS complain of sleep disorders. In a study of 133 patients, a large majority of RLS patients (84.7%) often had difficulty in falling asleep at night, and 86% reported that the symptoms of RLS woke them up frequently during the night [169]. Periodic leg movement during sleep (PLMS) is a typical symptom of RLS. The prevalence of PLMS is 3.9% and RLS was 5.5% [170]. RLS and PLMS are higher in women than in men. The prevalence of RLS increases significantly with age. Studies evaluating the relevance between PLMS and RLS reported that approximately 80% of patients with RLS have a pathological rate of PLMS defined as > 5 PLMS/h of sleep [144][169][170].

The measurement of PLMS can be an important indicator for assessing the severity of RLS [171][172][173].

According to standard criteria [143][144], PLMS are only scored if they are part of a series of four or more consecutive movements of 0.5 to 10 seconds duration with an inter-movement interval of 5 to 90 seconds and an amplitude greater than 8 mV above the basic electromyograph (EMG) signal. A PLMI greater than 5 for the entire night of sleep considered as pathological can still be used for younger people, but a PLMI greater than 15 is now often used as a threshold for older subjects. As for others sleep disorders, PSG is considered as the only clinically acceptable way to quantify PLMS [34]. However, PSG has many drawbacks such as its high cost, invasiveness, difficulty to use, and can usually only be tested once in hospital for a same patient. It is therefore useful to develop a cheap, non-invasive, easy to operate PLMS detection device suitable for long-term monitoring at home. Based on the standard diagnostic criteria for PLMS, we define the PLMS detection rule using our proposed foot module, as described in section 2.4.3 of Chapter 2.

4.2 Results and discussion

The number of PLMS per hour during sleep detected by this rule is defined as the PLMS index, which is the diagnostic indicator for PLMS based on the foot module. The PLMS detected by our foot module is shown in Figure 66. The PLMS is marked by a red vertical line (lines with height that reach the top), each red vertical line means one second with the PLMS. The blue vertical line (lines with height that do not reach the top) indicates the left foot movement level collected by our left foot module.

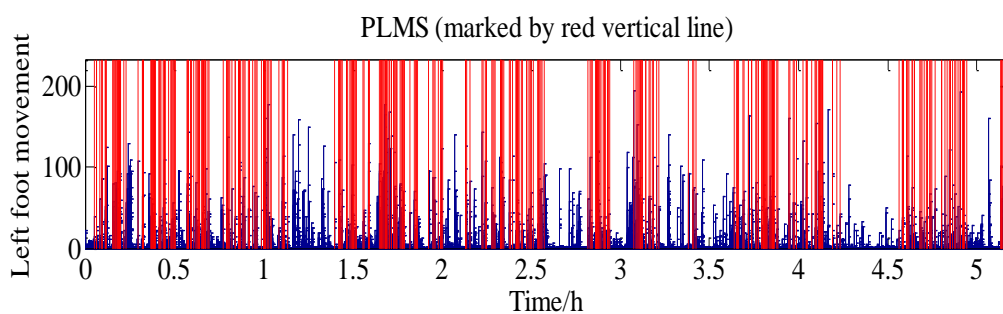

Figure 66. PLMS detected by our foot module.

The number of PLMS distributed in each sleep stage detected by the PSG and our left foot module is shown in Table 23.

Table 23. Number of PLMS distributed in each sleep stage.

	Total	Awake	REM	Light sleep	Deep sleep
PSG	56	47	0	6	3
Our module	57	48	0	9	0

As we can see, the total number of PLMS given by PSG report is very close from the result of the PSG and from our foot module. Furthermore, the number of PLMS distributed at each sleep stage is also very close from the result of the PSG and from our foot module. The main difference between the two exists in the PLMS distribution in light sleep and deep sleep. The PSG detects 3 PLMS in deep sleep but our foot module doesn't detect any PLMS during deep sleep. In light sleep, our foot module detects 3 more PLMS than the PSG. The reason why our foot module does not detect any PLMS during deep sleep may be that the limb movement is very slight during deep sleep so that the movement level of some foot movements does not reach the threshold of foot movement. Therefore, PLMS during deep sleep is not detected. In addition, in this night sleep, the duration of deep sleep is also very short, which also increases the difficulty of detecting PLMS.

5 Links between skin temperature and hypnogram

5.1 Data processing

Looking at Figure 33 in section 3.4 of Chapter 3, we can see some links between temperature of three body parts (chest, finger and toe) and hypnogram of the PSG. The longest continuous sleep episode and the only deep sleep episode are observed near 4.5 hours. During this time, the temperature of the chest, fingers and toes is stable and very close to each other around 4.5 hours.

We define chest temperature as T_{c_i} , finger temperature as T_{f_i} , toe temperature as T_{t_i} . Then we calculate the sum of their respective differences, denoted $SD3T_i$.

$$SD3T_i = |T_{c_i} - T_{f_i}| + |T_{c_i} - T_{t_i}| + |T_{f_i} - T_{t_i}| \quad (5-1)$$

Where i is the index of the sample, temperature being sampled every second.

5.2 Results

The synchronous comparison between $SD3T$ and the PSG hypnogram is shown in Figure 67. In Figure 67(a), the dashed box corresponds to the period when sleep is continuous and most of these periods are deep sleep. Also in Figure 67(b), the red dashed box shows the period when the $SD3T$ remains low and stable. This phenomenon suggests that a stable and low $SD3T$ may correspond to restful and continuous sleep.

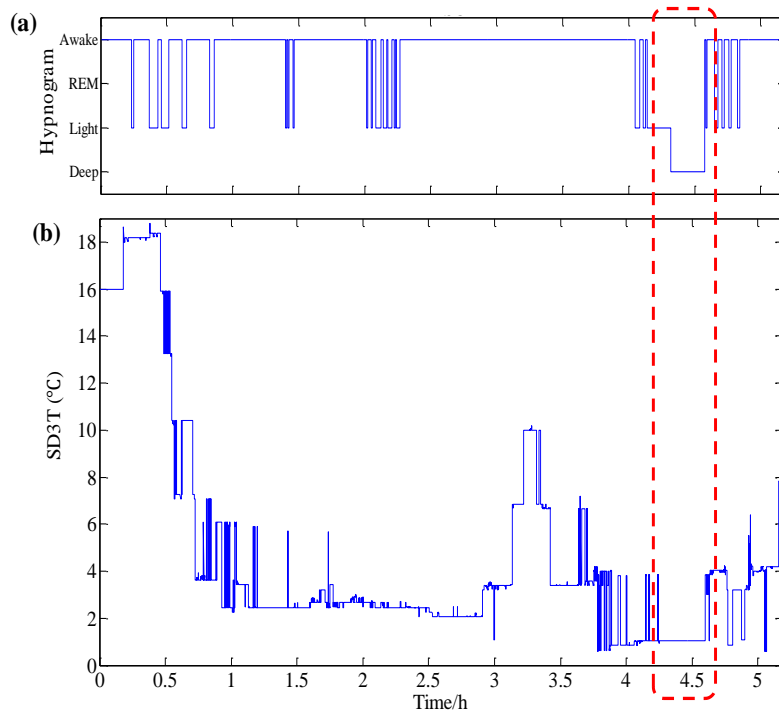

Figure 67. Synchronous comparison between SD3T and the PSG hypnogram. (a) Hypnogram obtained by PSG. (b) SD3T.

6 Links between skin temperature and PLMS

6.1 Data processing

By observing the temperature curves of the finger and toe in Figure 3.8 of chapter 3, there seems to be some correlation between the appearance of PLMS and temperature changes. Therefore, we perform a first-order difference for finger and toe temperature during the night, denoted DTf and DTt respectively, as equations (5-2) and (5-3).

$$DTf_i = |Tf_i - Tf_{i-1}| \quad i = 2, 3, \dots, N \quad (5-2)$$

$$DTt_i = |Tt_i - Tt_{i-1}| \quad i = 2, 3, \dots, N \quad (5-3)$$

Where i is the temperature index of the sample, N is the total number of samples. More precisely, we set $DTf_1 = DTt_1 = 0$.

6.2 Results

The synchronous comparison between DTt, DTf and PLMS overnight is shown in Figure 68.

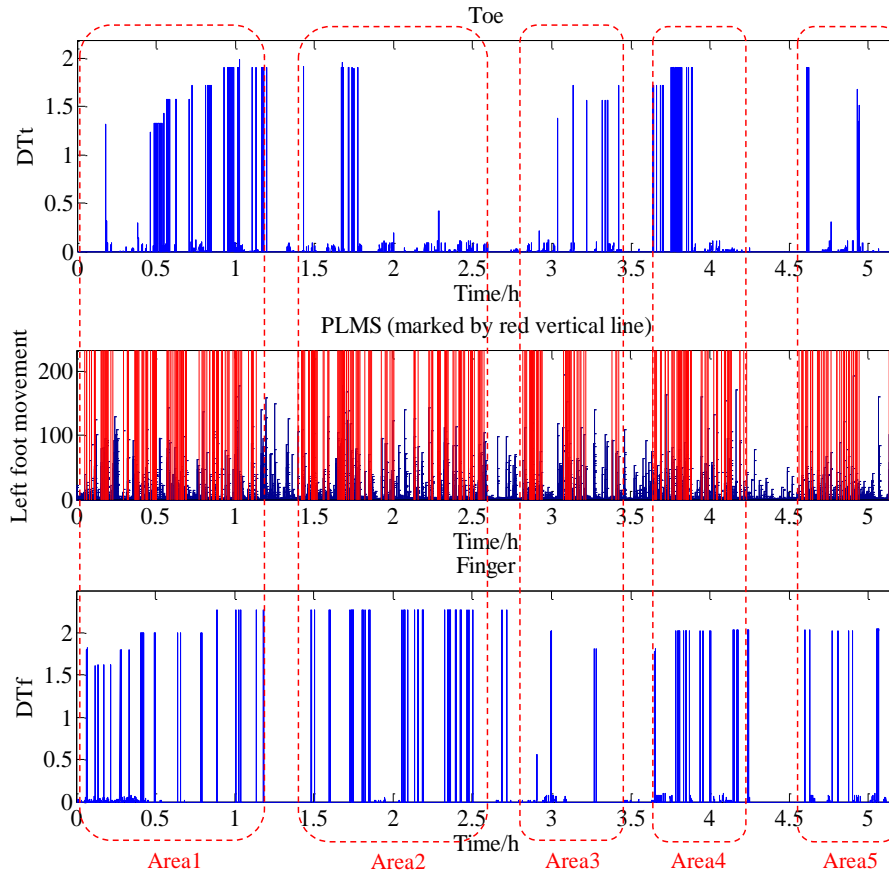

Figure 68. Synchronous comparison between DTt, DTf and PLM overnight.

By observing Figure 68, the distribution of PLMS is lowly correlated with DTt but highly correlated with DTf. In Figure 68, five relatively independent groups can be found through observation, we therefore divide the overnight time into 5 areas as marked by the dashed box in Figure 68, each area containing a relatively concentrated set of PLMS events. Each area contains a relatively concentrated set of high values of DTf, i.e. a relatively large change in finger temperature. In addition, the density of the PLMS distribution and the density of DTf are similar in each area. In areas 1, 2 and 4, the emergence of PLMS is very dense, and the emergence of the high DTf value is also relatively dense. In areas 3 and 5, the emergence of PLM is relatively low, and the emergence of high DTf value is also relatively low. In part of areas 1 and 2, part of areas 3 and 4, part of areas 4 and 5, there is no emergence of PLMS, nor is there a significant DTf value.

Based on these phenomena we can assume that the emergence of PLMS is positively correlated with the DTf value. PLMS is maybe more correlated with finger temperature than toe temperature.

7 Conclusion

In this chapter, we have performed a preliminary validation of the four methods proposed for the sleep stages classification with reference to the PSG gold standard. Based on the confusion matrix analysis, the results show that the proposed T2 method has a fair agreement with the PSG and that the other three methods show a slight agreement with the PSG. The T1, T2 and Mkm2 methods are efficient for the detection of awake. The T1, 5km2 and Mkm2 methods are efficient for the detection of deep sleep. All the proposed methods are relatively less efficient for the detection of REM and light sleep. In general, the T1 method is the most efficient among the four methods proposed. For PLMS detection, we define the detection rules based on the foot movement data acquired by our proposed foot module. The results show that the total number of PLMS and the number of PLMS distributed in each sleep stage detected by our foot module are both very close to the PSG. Furthermore, we explore the links between skin temperature and hypnogram and between skin temperature and PLMS. We have found that the lower and flat continuous SD3T corresponds to continuous sleep and even deep sleep, that the emergence of PLMS is positively correlated to the DTf value and that PLMS is more correlated to finger temperature than to toe temperature. This experiment has shown that it would be possible to predict PLMS based on the change in finger temperature. Nevertheless, further investigative work over several nights and several subjects should confirm this observation.

General conclusion

Sleep monitoring is a very important medical issue because it is recognized that the quality of sleep has a strong impact on health and consequently on well-being and quality of life. We wished to address this subject from the sleep observation and measurement point of view by using the least invasive and intrusive technical devices. Indeed, currently, the gold standard used for sleep monitoring is the PSG technique, which is an intrusive method that can only be used in a clinical setting. Several studies have focused on the development of methods and strategies for lighter and long-term monitoring. However, these monitoring systems still raise questions about the acceptance of wearing these devices by users, about their implementation in real conditions, about socio-economic aspects, about privacy and impact on society, but also about the performance of the proposed algorithmic processing.

For this purpose, we have carried out a systematic review on the current state and future challenges of SMS under these different aspects. This study allowed us to propose a first original SMS solution for home deployment and longitudinal monitoring. This solution includes a hardware architecture based on standard telecommunications technologies and sleep monitoring data processing algorithms used in the AI field. The solution has been tested on volunteers and performances have been evaluated.

In this work, we first provide an overview of the current state and future prospects of research and development of sleep monitoring systems. The different solutions reported in the literature and available on the market are reviewed. Systematic evaluations of the effectiveness and efficiency of sleep monitoring system are considered as key issues to ensure potential user acceptance. Sleep monitoring is important for both individuals and clinicians. Beyond healthy lifestyle interest and clinical diagnosis, sleep monitoring may also be important in reducing work-related injuries due to fatigue, particularly for lone workers. However, this type of monitoring will only be practical if systems with proven reliability and validity are in place. Consumers and patients will have the opportunity to take part in the personal health data revolution. Increasingly powerful and convenient wearable technologies will be able to provide rich health information, but it is not clear that this will translate into workable health decisions. The democratization of devices previously reserved for physicians should improve access to health data and overall awareness of personal health. It is important that such information is properly communicated to and understood by consumers. More complex integrated sensor technologies, detection, and analytical algorithms are likely to be

developed in the coming years. Other wearable diagnostic tools for consumers, or even implantable devices and nanotechnologies, are currently under development. Ideally, these technologies will empower consumers and patients and promote preventive medicine. The most important challenges are the development of nonintrusive hardware implementation, smart signal processing, data analysis and interpretation, interoperability of communication standards, efficiency of electronic component, energy self-sufficiency, and long-term monitoring.

To address some of these challenges, our proposed hardware architecture includes sensors, a master board, a gateway and a smartphone application, allowing the user to control the operation of the entire system including turning the system on and off, uploading and downloading data, simply by using the custom smartphone application via BLE. The sensors are integrated into several sleep monitoring modules, including a chest module, a wrist module, a foot module, a sound module and an ambient module. The sleep monitoring modules acquire comprehensive sleep-related data for indicators such as sleep stages, PLMS and snoring. Thanks to Wireless Sensor Networks (WSNs) and BodyLAN technology, only three small size and lightweight wireless sleep monitoring modules (one chest module, one wrist module and one foot module) are attached to the body. Unlike a completely non-contact approach, attaching an appropriate number of non-intrusive sleep monitoring modules to the body ensures that valuable and reliable physiological data can be collected and avoids causing unacceptable user discomfort. Although the system contains several sleep monitoring modules that collect data at the same time, the master board can control their operating status and download the data they each collect via BLE and send it to the gateway via LoRa. If the user is in an environment without internet coverage, the gateway can be placed in a location with internet coverage and the sleep monitoring data can first be transmitted to the gateway via LoRa, then the gateway can upload the data to the server through Internet connection. The gateway can be placed at a distance up to 10 km from the user, but by increasing the number of gateways, the distance at which the gateway can be placed can theoretically be infinite. This is useful for users in areas with less Internet coverage.

Sleep stage classification algorithms are based solely on wrist movements acquired by a wrist module with an accelerometer are proposed. These algorithms include the threshold-based method (T1 method and T2 method) and the k-means clustering method (5km2 method and Mkm2 method). Both T1 and T2 threshold-based methods use three thresholds to achieve the falling asleep/ waking up detection and the sleep stages (“awake”, “light sleep”, “deep sleep” and “REM”) classification, but T1 and T2 methods adopt different threshold values. The k-means clustering method allows the

classification of sleep stages (“awake”, “light sleep”, “deep sleep” and “REM”) by performing a k-means clustering ($k=2$) 5 (5km2) or more (Mkm2) times. We recruited 5 volunteers (2 men, 3 women) who carried out validation tests for 16 full nights. The results obtained were compared to two reference products: the "Fitbit Charger 2" watch and the Withings mattress. Among the 16 nights, 10 nights show that the “5km2” method is better than the “Fitbit” and the T1 methods, 4 nights show close performance with other approaches, and only 2 nights show that the “5km2” method is worse. Moreover, we have defined a sleep score calculation method to assess the quality of sleep of a full night. With tests conducted over 16 nights, the sleep score obtained by the methods we propose shows a promising performance in determining whether sleep is good or not. Furthermore, we take the mean value of the two commercial products “Fitbit” and “Withings” as a reference to validate the four proposed methods. Experimental data are acquired from 17 overnights sleep of two volunteers with no sleep disorder. For the detection of the falling asleep and waking up time, the proposed method shows a deviation of 13.3 ± 11.4 mins and 8.6 ± 10.0 mins respectively from the reference. For the detection of the cumulative duration of each sleep stage a p-value is calculated, and only the Mkm2 method for volunteer 1 and T2 method for volunteer 2 show a statistically significant difference with the reference for respectively the REM and light sleep stages. Meanwhile, Bland-Altman's plots show that the number of points outside the 95% agreement limit compared to the reference for the “T1”, “T2”, “5km2” and “Mkm2” methods is 3, 3, 1 and 4 respectively. It shows that the four proposed methods are in good agreement with the reference.

A preliminary validation of the four methods proposed for the sleep stages classification with reference to the PSG gold standard is also performed. Based on the confusion matrix analysis, the results show that the proposed T2 method has a fair agreement with the PSG while the other three methods show a slight agreement with the PSG. The T1, T2 and Mkm2 methods are efficient for the detection of awake. The T1, 5km2 and Mkm2 methods are efficient for the detection of deep sleep. All the proposed methods are relatively less efficient for the detection of REM and light sleep. In general, the T1 method is the most efficient among the four methods. For PLMS detection, we define the detection rules based on the foot movement data acquired by our proposed foot module. The results show that the total number of PLMS and the number of PLMS distributed between each sleep stage detected by our foot module are both very close to the PSG. Furthermore, we explore the links between skin temperature and hypnogram and between skin temperature and PLMS. We found that the lower and flat continuous SD3T (the sum of the respective differences between the temperature of the chest, fingers and toes) corresponds to continuous sleep and even deep sleep, and that the emergence of PLMS is positively correlated to the DTf (first-order difference in finger temperature

during the night) value and that PLMS is more correlated to finger temperature than to toe temperature. This experiment has shown that it would be possible to predict PLMS based on the change in finger temperature.

Finally, this work presents a first complete solution for long-term sleep monitoring at home, but there is still ways of improvement:

-On the hardware:

In terms of hardware, reducing energy consumption was an urgent consideration for our system. The wireless sleep monitoring module is powered by a coin cell battery, and a 220mAh battery will only provide continuous power to the module for 2-3 nights. A total of four modules need to be powered by coin cell batteries and the cost of one battery is around 1 Euro. The cost of the batteries currently consumed by the system is high, which does not benefit the implementation of long-term monitoring. To solve this issue, two directions have to be considered. The first one is to use components that consume less energy, for example we can choose lower power processors and sensors meeting the task requirements. The second direction is to use rechargeable batteries to power the wireless modules, for example by induction for ease of use, to avoid the ongoing expense of frequent battery changes.

Another consideration is the miniaturization of the device to be worn on the body. It must be light and have a shape factor adapted to the location where it is installed.

-On the algorithms:

In terms of algorithms, we have considered three main directions to further improve the performance of the proposed algorithm. First, more volunteers need to be recruited to perform more nights of PSG testing. The PSG results will then be used as a reference and the proposed algorithm will be modified accordingly so that the results are as close as possible to the PSG. At the same time, if enough data from the PSG test is available, we may consider adopting supervised machine learning methods such as support vector machine, random forest, linear discriminant, etc. or even deep learning techniques to try to further improve the performance of the algorithm. In addition, for the sleep stage classification algorithms, we only consider features based on wrist movement in current work. Based on the correlation we found between skin temperature and hypnogram, we can consider adding skin temperature to the existing feature set to improve the algorithm performance and strengthen the sleep diagnosis.

-On deployment in real conditions:

Regarding the deployment of the system in real conditions, we do not currently have a good housing for our sleep monitoring modules. For all the modules that need to be attached to the body, we simply wrapped them in paper and then taped them to the corresponding body part, which is rudimentary and inconvenient to deploy; this is only a temporary solution for testing purposes. In practice, in the future, we hope to work with relevant product design teams to design and manufacture aesthetically, pleasing and user-friendly packages for each module.

Finally, the device must be able to be installed and used by the patient himself/herself in a short period of time.

-On the connection to the medical practices:

The ultimate goal of our system is to help physicians better understand sleep conditions so that they can prescribe perfectly adapted recommendations to improve patients' sleep quality. It is only by fully understanding the needs of physicians and users that we will be able to better link our proposed system to medical practices. That is why in the future, we hope to invite more physicians and users to use our system free of charge, then communicate with them about their experience and ask for their comments and suggestions, which will help us determine the direction of system improvement. We have begun to exchange in this way with the sleep unit of the Purpan hospital. In addition, sleep apnea monitoring is also an important topic in sleep monitoring research area. The PSG is the gold standard in sleep apnea monitoring. The sound module we propose has the ability to detect snoring without contact but does not yet have the ability to detect sleep apnea events. Therefore, in order to make our system a better alternative to the PSG, one of the future directions of our work would be to improve the hardware and algorithms currently used in the sound module to make it capable of detecting sleep apnea events.

Appendix I. Hardware implementation in different works.

Sensors	Source	Parameters obtained	Sensor type	Position	Possible description of sleep phases	Advantages	Drawbacks
Accelerometer	Seba et al [97]	Acceleration of the wrist	XSENS	Wrist	<p>1) Body movement is becoming less intense and less frequent as we fall into the deeper phases of sleep [72].</p> <p>2) In REM, people tend to exhibit large body movements. Whereas in the deep sleep stage, it accompanied with slight body movements such as arm trembling and leg jerking [91].</p> <p>3) In general movements during sleep provide valuable information about sleep quality [74].</p> <p>4) The movements are associated with the Wake stage and light stages of NREM as a result of changes in sleep posture that occurs every 5-10 minutes. REM sleep, on the other hand, is characterized by muscle immobility and body paralysis to prevent sleepers from acting out their dreams and hurting themselves [92].</p>	A widely used sensor, efficient to detect body motion.	It is usually need to be attached or worn by the subjects during sleep.
	Saad et al [90]	Body movement	Not mentioned	Not mentioned			
	Velicu et al [72]	Wrist activity	MPU6050	Wrist belt			
	Kalkbrenner et al [74]	1) sleeping position; 2) movements of the patient	MPU-6000 (by InvenSense)	Abdominal belt			
	Suzuki et al [93]	Motion	Not mentioned	Chest			
	Suzuki et al [80]	Amount of activity	Not mentioned	Wrist			
	Lee et al [99]	Movement and the body's posture	LIS3DH, ST Microelectronics	Torso			
	Chan et al [94]	Activity, posture	Not mentioned	<p>1) The left midclavicular line over intercostal space (ICS) 2</p> <p>2) Vertically over the upper sternum</p> <p>3) Horizontally on the left midclavicular line over ICS 6</p>			
Beattie et al [105]	Motion	3D accelerometer without the mention of the type	Left and right wrist				
Kim et al [120]	Body movement	BMA250E	Under the mattress				
Microphone	Kalkbrenner et al [74]	1) Breathing sound ; 2) heart sound	Not mentioned	Suprasternal notch	<p>1) Breathing varies when we are awake or during REM sleep, but they are more stable and regular when we are in NREM sleep [72].</p>	<p>1) It can effectively record snore, breathing sound even the heartbeat sound.</p> <p>2) It can be</p>	It should be used in quiet environment, easy to be disturbed by noise.
	Chang et al [121]	Acoustic signal	Built-in microphone of smartphone	Next to bed			

					2) In REM, breathing rate is commonly unstable. Whereas in the deep sleep stage, breathing rate becomes slower and more regular [91].	placed close to the subject without any contact.	
Thermopile sensor (Infrared)	Seba et al [97]	Temperature of upper part of the "bed + patient"	TMP007	Remotely from the patient	The same as accelerometer.	A simple and non-contact technology for human presence and motion detection.	1) Easily affected by dust, strong light interference. 2) Can only detect fixed area. 3) Can't detect small movement.
	Guettari et al [42]	1) human presence in the bed ; 2) movements of a person during sleep	Not mentioned	Fixed on the wall			
	Teruaki et al [119]	Body movement	DC-NCR300U	Fixed on the wall of the bedroom			
Temperature sensor	Seba et al [97]	Skin temperature	IButtons	1) Hand 2) Foot 3) Axillary	1) The cutaneous temperature increases during sleep and decreases during waking [77]. 2) The normal core body temperature is usually 37 °C, and can be slightly decreased during sleep [120].	A kind of sensor with many types. It can be used to detect skin temperature or environment temperature during sleep.	1) Very high requirement for the resolution (at least 0.2°C) when used to detect skin temperature. 2) Correlation between temperature and sleep quality is proved in state of the art but using only thermal signals to estimate sleep quality is not the easiest way [42].
	Suzuki et al [93]	Skin temperature	Not mentioned	Chest			
	Saad et al [90]	Skin temperature	Thermistor	The Thermistor clipped on any of fingertip for a few second to get a consistent skin temperature reading			
ECG sensor	Velicu et al [72]	ECG wave	Not mentioned	Not mentioned	1) Breathing and heart rate vary when we are awake or during REM sleep, but they are more stable and regular when we are in NREM sleep [72]. 2) Heart rate becomes more stable as sleep deepens [72].	It allows to record ECG wave, which is highly correlated with sleep stage.	It must be attached or worn generally at chest by subjects during sleep.
	Suzuki et al [93]	ECG wave	Pseudo-Soc	Chest			
	Lee et al [99]	Heart rate variability	An Ag-/AgCl based electrode array	Torso			
	Chan et al [122]	Heart rate and heart rate variability	Not mentioned	1) The left midclavicular line over intercostal space (ICS) 2) Vertically over the upper sternum 3) Horizontally on the left			

				midclavicular line over ICS 6			
Pulse sensor	Suzuki et al [93]	Pulse wave	Photoplethysmogram	Chest	The correlation coefficient between PPIs and R-R intervals of ECG is 0.96 [80].	1) For the purpose of calculating heart rate, it can be placed at wrist, relatively less intrusive than ECG sensor. 2) The result is very close to ECG sensor [80].	It must be attached or worn by subjects during sleep.
	Suzuki et al [80]	Pulse-to-pulse intervals (PPI)	Photoelectric	Wrist			
	Saad et al [90]	Heart rate	Not mentioned	Simply attach to anywhere near the blood vessel			
	Beattie et al [105]	Heart rate	Optical pulse photoplethysmograph (PPG)	Wrist			
Pressure sensor	Sadek et al [95]	1) Heart rate 2) Respiration	Microbend fiber optic sensor embedded in sleep mat (Mat dimensions: 20 cm 50 cm 0.5 cm)	Sleep mat is positioned on the operating room table approximately below the patient's chest and stomach.	1) Breathing and heart rate vary when we are awake or during REM sleep, but they are more stable and regular when we are in NREM sleep [72]. 2) Heart rate becomes more stable as sleep deepens [72]. 3) The ballistocardiogram (BCG) signal records the mechanical activity originating from the rebound of the body, generated when the blood is pumped out of ventricles into the large blood vessel synchronous with each heart beat [96].	1) A widely used sensor, with many types for different applications. 2) It's a simple and efficient method to detect body motion even breathing and heart rate. 3) When embedded in mat or mattress, it can be a noninvasive method.	Relatively short lifespan
	Sadek et al [96][98]	Ballistocardiogram (BCG) signal (heart rate)	Microbend fiber optic sensor embedded in pressure mat.	The sensor is embedded in the headrest of the massage chair			
	Sadek et al [104]	Ballistocardiogram (BCG) signal (heart rate)	Fiber Bragg Grating (FBG) sensor embedded in a mat.	The FBG sensor mat is placed over a bed, under a thin bed sheet, where the locations of the arrays are under the head, under the chest, under chest and abdomen, and under hips respectively.			
	Samy et al [100]	Respiration rate, leg movement, body movement, posture and body Orientation	The e-textile piezoresistive fabric	Three-stacked-layer structure of the e-textile bed sheet. The e-textile piezoresistive fabric is sandwiched between two orthogonal conductive bus layers.			

References

- [1] Van de Straat V, Buffel V, Bracke P. Medicalization of Sleep Problems in an Aging Population: A Longitudinal Cross-National Study of Medication Use for Sleep Problems in Older European Adults. *Journal of Aging and Health*; 2018.
- [2] Bao Y P, Han Y, Ma J, et al. Cooccurrence and bidirectional prediction of sleep disturbances and depression in older adults: meta-analysis and systematic review. *Neuroscience & Bio behavioral Reviews*; 2017, 75: 257-273.
- [3] Dregan A, Armstrong D. Cross-country variation in sleep disturbance among working and older age groups: an analysis based on the European Social Survey. *International psychogeriatrics*, 2011, 23(9): 1413.
- [4] Jafari, B., & Mohsenin, V. (2010). Polysomnography. *Clinics in chest medicine*, 31(2), 287-297.
- [5] Chan M, Campo E, Estève D. Assessment of activity of elderly people using a home monitoring system. *International Journal of Rehabilitation Research*; 2005, 28(1): 69-76.
- [6] Campo E, Bonhomme S, Chan M, et al. Remote tracking patients in retirement home using wireless multisensor system//e-Health Networking Applications and Services (Healthcom), 2010 12th IEEE International Conference on. IEEE; 2010: 226-230.
- [7] Charlon Y, Campo E, Brulin D. Design and evaluation of a smart insole: Application for continuous monitoring of frail people at home. *Expert Systems with Applications*; 2018, 95: 57-71.
- [8] Reutrakul S, van Cauter E. Sleep influences on obesity, insulin resistance, and risk of type 2 diabetes. *Metabolism* 2018 Jul; 84:56-66.
- [9] Tobaldini E, Costantino G, Solbiati M, Cogliati C, Kara T, Nobili L, et al. Sleep, sleep deprivation, autonomic nervous system and cardiovascular diseases. *Neurosci Biobehav Rev* 2017 Mar;74(Pt B):321-329.
- [10] Suzuki H, Savitz J, Kent Teague T, Gandhapudi SK, Tan C, Misaki M, et al. Altered populations of natural killer cells, cytotoxic T lymphocytes, and regulatory T cells in major depressive disorder: association with sleep disturbance. *Brain Behav Immun* 2017 Nov;66:193-200
- [11] Lewis PA, Knoblich G, Poe G. How memory replay in sleep boosts creative problem-solving. *Trends Cogn Sci* 2018 Jun;22(6):491-503.
- [12] Huber R, Born J. Sleep, synaptic connectivity, and hippocampal memory during early development. *Trends Cogn Sci* 2014 Mar;18(3):141-152.
- [13] Scullin MK, Bliwise DL. Sleep, cognition, and normal aging: integrating a half century of multidisciplinary research. *Perspect Psychol Sci* 2015 Jan;10(1):97-137
- [14] Gami AS, Howard DE, Olson EJ, Somers VK. Day-night pattern of sudden death in obstructive sleep apnea. *N Engl J Med* 2005 Mar 24;352(12):1206-1214.
- [15] Stranges S, Tigbe W, Gómez-Olivé FX, Thorogood M, Kandala NB. Sleep problems: an emerging global epidemic? Findings from the INDEPTH WHO-SAGE study among more than 40,000 older adults from 8 countries across Africa and Asia. *Sleep* 2012 Aug 1;35(8):1173-1181

- [16] Sutton DA, Moldofsky H, Badley EM. Insomnia and health problems in Canadians. *Sleep* 2001 Sep 15;24(6):665-670.
- [17] Kessler RC, Berglund PA, Coulouvrat C, Hajak G, Roth T, Shahly V, et al. Insomnia and the performance of US workers: results from the America insomnia survey. *Sleep* 2011 Sep 1;34(9):1161-1171
- [18] Uehli K, Mehta AJ, Miedinger D, Hug K, Schindler C, Holsboer-Trachsler E, et al. Sleep problems and work injuries: a systematic review and meta-analysis. *Sleep Med Rev* 2014 Feb;18(1):61-73
- [19] Filip I, Tidman M, Saheba N, Bennett H, Wick B, Rouse N, et al. Public health burden of sleep disorders: underreported problem. *J Public Health* 2016 Dec 6;25(3):243-248
- [20] Hafner M, Stepanek M, Taylor J, Troxel WM, van Stolk C. Why sleep matters-the economic costs of insufficient sleep: a cross-country comparative analysis. *Rand Health Q* 2017 Jan;6(4):11
- [21] Allan Hobson J. A manual of standardized terminology, techniques and scoring system for sleep stages of human subjects. *Clin Neurophysiol* 1969 Jun;26(6):644.
- [22] Iber C, Ancoli-Israel S, Chesson A, Quan S. The AASM Manual for the Scoring of Sleep and Associated Events. American Academy of Sleep Medicine. 2007. URL: <https://aasm.org/clinical-resources/scoring-manual/> [accessed 2020-08-13]
- [23] Moser D, Anderer P, Gruber G, Parapatics S, Loretz E, Boeck M, et al. Sleep classification according to AASM and Rechtschaffen & Kales: effects on sleep scoring parameters. *Sleep* 2009 Feb;32(2):139-149
- [24] Himanen S, Hasan J. Limitations of Rechtschaffen and Kales. *Sleep Med Rev* 2000 Apr;4(2):149-167.
- [25] Fino E, Mazzetti M. Monitoring healthy and disturbed sleep through smartphone applications: a review of experimental evidence. *Sleep Breath* 2019 Mar;23(1):13-24.
- [26] Westerlund A, Lagerros YT, Kecklund G, Axelsson J, Åkerstedt T. Relationships between questionnaire ratings of sleep quality and polysomnography in healthy adults. *Behav Sleep Med* 2016;14(2):185-199.
- [27] Sateia MJ. International classification of sleep disorders-third edition: highlights and modifications. *Chest* 2014 Nov;146(5):1387-1394.
- [28] Ohayon MM. Epidemiology of insomnia: what we know and what we still need to learn. *Sleep Med Rev* 2002 Apr;6(2):97-111.
- [29] Avcı C, Akbaş A. Sleep apnea classification based on respiration signals by using ensemble methods. *Bio-Med Mater Eng* 2015 Aug 17;26(s1):S1703-S1710.
- [30] Hou L, Xie S, Kai S. Detection of OSAHS Using Only Time-Domain Property of Snoring Signal. In: International Conference on Multimedia Technology. 2011 Presented at: ICMT'11; Jul 26-28, 2011; Hangzhou, China.
- [31] Karunajeewa AS, Abeyratne UR, Hukins C. Multi-feature snore sound analysis in obstructive sleep apnea-hypopnea syndrome. *Physiol Meas* 2011 Jan;32(1):83-97.
- [32] Solà-Soler J, Fiz JA, Morera J, Jané R. Multiclass classification of subjects with sleep apnoea-hypopnoea syndrome through snoring analysis. *Med Eng Phys* 2012 Nov;34(9):1213-1220.

- [33] Walters AS, LeBrocq C, Dhar A, Hening W, Rosen R, Allen TP, International Restless Legs Syndrome Study Group. Validation of the international restless legs syndrome study group rating scale for restless legs syndrome. *Sleep Med* 2003 Mar;4(2):121-132.
- [34] Plante DT. Leg actigraphy to quantify periodic limb movements of sleep: a systematic review and meta-analysis. *Sleep Med Rev* 2014 Oct;18(5):425-434
- [35] Terrill PI, Leong M, Barton K. Measuring Leg Movements During Sleep Using Accelerometry: Comparison With EMG and Piezo-Electric Scored Events. In: 35th Annual International Conference of the IEEE Engineering in Medicine and Biology Society. 2013 Presented at: EMBC'13; July 3-7, 2013; Osaka, Japan p.6865.
- [36] Madhushri P, Ahmed B, Penzel T. Periodic Leg Movement (PLM) Monitoring Using a Distributed Body Sensor Network. In: 37th Annual International Conference of the IEEE Engineering in Medicine and Biology Society. 2015 Presented at: EMBC'15; August 25-29, 2015; Milan, Italy.
- [37] Ohayon MM, Roth T. Prevalence of restless legs syndrome and periodic limb movement disorder in the general population. *J Psychosom Res* 2002 Jul;53(1):547-554.
- [38] Montplaisir J, Allen RP, Arthur W. Restless Legs Syndrome and Periodic Limb Movements During Sleep. Italian Ministry of Health. 2010. URL: <https://moh-it.pure.elsevier.com/en/publications/restless-legs-syndrome-and-periodic-limb-movements-during-sleep-2> [accessed 2020-08-13]
- [39] Zucconi M, Ferini-Strambi L. NREM parasomnias: arousal disorders and differentiation from nocturnal frontal lobe epilepsy. *Clin Neurophysiol* 2000 Sep;111(Suppl 2):S129-S135.
- [40] Ferini-Strambi L, Zucconi M. REM sleep behavior disorder. *Clin Neurophysiol* 2000 Sep;111:S136-S140.
- [41] Gitanjali B. Establishing a polysomnography laboratory in India: problems and pitfalls. *Sleep* 1998 Jun 15;21(4):331-332.
- [42] Guettari T, Istrate D, Boudy J, Benkelfat B, Fumel B, Daviet J. Design and first evaluation of a sleep characterization monitoring system using a remote contactless sensor. *IEEE J Biomed Health Inform* 2017 Nov;21(6):1511-1523.
- [43] Liu J, Chen Y, Wang Y, Chen X, Cheng J, Yang J. Monitoring vital signs and postures during sleep using WiFi signals. *IEEE Internet Things J* 2018 Jun;5(3):2071-2084.
- [44] Roomkham S, Lovell D, Cheung J, Perrin D. Promises and challenges in the use of consumer-grade devices for sleep monitoring. *IEEE Rev Biomed Eng* 2018;11:53-67.
- [45] Gu W, Shangguan L, Yang Z, Liu Y. Sleep hunter: towards fine grained sleep stage tracking with smartphones. *IEEE Trans on Mobile Comput* 2016 Jun 1;15(6):1514-1527.
- [46] Barrón-González HG, Martínez-Espronedá M, Trigo JD, Led S, Serrano L. Proposal of a novel remote command and control configuration extension for interoperable personal health devices (PHD) based on ISO/IEEE11073 standard. *Conf Proc IEEE Eng Med Biol Soc* 2014;2014:6312-6315.

- [47] Arney D, Plourde J, Goldman JM. OpenICE medical device interoperability platform overview and requirement analysis. *Biomed Tech (Berl)* 2018 Feb 23;63(1):39-47.
- [48] McHill AW, Wright KP. Role of sleep and circadian disruption on energy expenditure and in metabolic predisposition to human obesity and metabolic disease. *Obes Rev* 2017 Feb;18(Suppl 1):15-24.
- [49] Lee SW, Ng KY, Chin WK. The impact of sleep amount and sleep quality on glycemic control in type 2 diabetes: a systematic review and meta-analysis. *Sleep Med Rev* 2017 Feb;31:91-101.
- [50] Fuchs FD, Fuchs SC, Martinez D. Obstructive sleep apnea-Hypertension link: almost there? *J Thorac Dis* 2017 Oct;9(10):3537-3540.
- [51] Hossain JL, Shapiro CM. The prevalence, cost implications, and management of sleep disorders: an overview. *Sleep Breath* 2002 Jun;6(2):85-102.
- [52] Deng F, Dong J, Wang X, Fang Y, Liu Y, Yu Z, et al. Design and implementation of a noncontact sleep monitoring system using infrared cameras and motion sensor. *IEEE Trans Instrum Meas* 2018 Jul;67(7):1555-1563.
- [53] Okubo M, Imai Y, Ishikawa T. Development of Automatic Respiration Monitoring for Home-care Patients of Respiratory Diseases With Therapeutic AIDS. In: 4th European Conference of the International Federation for Medical and Biological Engineering. 2008 Presented at: ECIFMBE'08; November 23-27, 2008; Antwerp, Belgium.
- [54] Coughlin JF. Aging & Family Caregiving: Why Should Financial Services Care? Massachusetts Institute of Technology. 2006. URL: <http://web.mit.edu/coughlin/Public/Publications/Coughlin%20Caregiving%20&%20Financial%20Services.pdf> [accessed 2020-08-13]
- [55] Barlow J, Bayer S, Curry R. Implementing complex innovations in fluid multi-stakeholder environments: experiences of 'telecare'. *Technovation* 2006 Mar;26(3):396-406.
- [56] World Internet Usage and Population Statistics. *Internet World Stats*. 2020. URL: <https://www.internetworldstats.com/stats.htm> [accessed 2020-03-03]
- [57] Kelly JM, Strecker RE, Bianchi MT. Recent developments in home sleep-monitoring devices. *ISRN Neurol* 2012;2012:768794.
- [58] Coiera E. Four rules for the reinvention of health care. *Br Med J* 2004 May 15;328(7449):1197-1199.
- [59] de VN, Robert F, Penders J. Wireless Body Area Network for Sleep Staging. In: IEEE Biomedical Circuits and Systems Conference. 2007 Presented at: BIOCAS'07; November 27-30, 2007; Montreal, Quebec.
- [60] Surantha N, Kusuma GP, Isa SM. Internet of Things for Sleep Quality Monitoring System: A Survey. In: 11th International Conference on Knowledge, Information and Creativity Support Systems. 2016 Presented at: KICSS'16; November 10-12, 2016; Yogyakarta, Indonesia.
- [61] van de Water AT, Holmes A, Hurley DA. Objective measurements of sleep for non-laboratory settings as alternatives to polysomnography--a systematic review. *J Sleep Res* 2011 Mar;20(1 Pt 2):183-200.

- [62] Schomer DL, de Silva HL. *Niedermeyer's Electroencephalography: Basic Principles, Clinical Applications, and Related Fields*. New York, USA: Lippincott Williams & Wilkins; 2005.
- [63] Chokroverty S. *Atlas of Sleep Medicine*. New York, USA: CRC Press; 2010.
- [64] Khalighi S, Sousa T, Pires G, Nunes U. Automatic sleep staging: a computer assisted approach for optimal combination of features and polysomnographic channels. *Expert Systems with Applications* 2013 Dec;40(17):7046-7059.
- [65] Vaughn B, Quint S, Messenheimer J, Robertson K. Heart period variability in sleep. *Clin Neurophysiol* 1995 Mar;94(3):155-162.
- [66] Townsend RE, Johnson LC, Naitoh P, Muzet AG. Heart rate preceding motility in sleep. *Psychophysiology* 1975 Mar;12(2):217-219.
- [67] Wu T, Wu F, Redoute J, Yuce MR. An autonomous wireless body area network implementation towards IoT connected healthcare applications. *IEEE Access* 2017;5:11413-11422.
- [68] Rathee D, Rangi S, Chakarvarti SK, Singh VR. Recent trends in wireless body area network (WBAN) research and cognition based adaptive WBAN architecture for healthcare. *Health Technol* 2014 May 24;4(3):239-244.
- [69] Milici S, Lazaro A, Villarino R, Girbau D, Magnarosa M. Wireless wearable magnetometer-based sensor for sleep quality monitoring. *IEEE Sensors J* 2018 Mar 1;18(5):2145-2152.
- [70] Younes M, Soiferman M, Thompson W, Giannouli E. Performance of a new portable wireless sleep monitor. *J Clin Sleep Med* 2017 Feb 15;13(2):245-258
- [71] Finan PH, Richards JM, Gamaldo CE, Han D, Leoutsakos JM, Salas R, et al. Validation of a wireless, self-application, ambulatory electroencephalographic sleep monitoring device in healthy volunteers. *J Clin Sleep Med* 2016 Nov 15;12(11):1443-1451
- [72] Velicu OR, Madrid NM, Seepold R. Experimental Sleep Phases Monitoring. In: *International Conference on Biomedical and Health Informatics*. 2016 Presented at: BHI'16; February 24-27, 2016; Las Vegas, NV, USA.
- [73] Kushida CA, Chang A, Gadkary C, Guilleminault C, Carrillo O, Dement WC. Comparison of actigraphic, polysomnographic, and subjective assessment of sleep parameters in sleep-disordered patients. *Sleep Med* 2001 Sep;2(5):389-396.
- [74] Kalkbrenner C, Eichenlaub M, Brucher R. Development of a new homecare sleep monitor using body sounds and motion tracking. *Curr Dir Biomed Eng* 2015;1(1):30-33.
- [75] Nakano H, Hayashi M, Ohshima E, Nishikata N, Shinohara T. Validation of a new system of tracheal sound analysis for the diagnosis of sleep apnea-hypopnea syndrome. *Sleep* 2004 Aug 1;27(5):951-957.
- [76] Yadollahi A, Giannouli E, Moussavi Z. Sleep apnea monitoring and diagnosis based on pulse oximetry and tracheal sound signals. *Med Biol Eng Comput* 2010 Nov;48(11):1087-1097.
- [77] Kalkbrenner C, Brucher R, Keszyüs T, Eichenlaub M, Rottbauer W, Scharnbeck D. Automated sleep stage classification based on tracheal body sound and actigraphy. *Ger Med Sci* 2019;17:Doc02

- [78] Lee S, Yan L, Roh T. The Smart Patches and Wearable Band (W-Band) for Comfortable Sleep Monitoring System. In: Annual International Conference of the IEEE Engineering in Medicine and Biology Society. 2011 Presented at: EMBC'11; August 30- September 3, 2011; Boston, USA.
- [79] Shambroom JR, Fábregas SE, Johnstone J. Validation of an automated wireless system to monitor sleep in healthy adults. *J Sleep Res* 2012 Apr;21(2):221-230.
- [80] Suzuki T, Ouchi K, Kameyama K. Development of a Sleep Monitoring System with Wearable Vital Sensor for Home Use. Science and Technology Publications. 2009. URL: <https://www.scitepress.org/papers/2009/17842/pdf/index.html> [accessed 2020-08-13]
- [81] Cole RJ, Kripke DF, Gruen W, Mullaney DJ, Gillin JC. Automatic sleep/wake identification from wrist activity. *Sleep* 1992 Oct;15(5):461-469.
- [82] Baharav A, Kotagal S, Gibbons V, Rubin BK, Pratt G, Karin J, et al. Fluctuations in autonomic nervous activity during sleep displayed by power spectrum analysis of heart rate variability. *Neurology* 1995 Jun;45(6):1183-1187.
- [83] Berry RB, Brooks R, Gamaldo CE, Harding SM, Lloyd RM. The AASM Manual for the Scoring of Sleep and Associated Events. American Academy of Sleep Medicine. 2015. URL: <https://aasm.org/clinical-resources/scoring-manual/> [accessed 2020-08-13]
- [84] Tataraidze A, Anishchenko L, Korostovtseva L, Kooij BJ, Bochkarev M, Sviryaev Y. Sleep stage classification based on respiratory signal. *Conf Proc IEEE Eng Med Biol Soc* 2015;2015:358-361.
- [85] Jawbone Up: Fitness Tracker Review. Live Science. 2013. URL: <https://www.livescience.com/40107-jawbone-up-review.html> [accessed 2013-10-02]
- [86] FitBit. 2020 Aug 11. URL: https://www.fitbit.com/fr/store?utm_source=&utm_medium=paidsearch&gclid=Cj0KCQjwv-DaBRcCARIsAI9sba9Dh12KY1zqUWJ1WLOZbS5BDheFt-ITkH3s-tE-652MtxsDMvoP3LgaAkgWEALw_wcB&dclid=CLevqriyutwCFcriGwodGHQL0Q [accessed 2020-08-11]
- [87] Sleepace. 2020. URL: <http://www.sleepace.com/en/reston.html?category=reston> [accessed 2020-08-11]
- [88] Sleep Dot B501. 2020. URL: <http://www.sleepace.com/en/dot.html?category=dot> [accessed 2020-08-11]
- [89] Withings Aura Sleep System. Sleep Trackers. 2020. URL: <https://sleeptrackers.io/withings-aura/> [accessed 2020-08-11]
- [90] Saad WH, Khoo CW, Ab Rahman SI, Ibrahim MM, Saad NH. Development of sleep monitoring system for observing the effect of the room ambient toward the quality of sleep. In: IOP Conference Series: Materials Science and Engineering. 2017 Presented at: IOP'17; June 12-16, 2017; Prague, Czech Republic.
- [91] Webb WB, Agnew HW. Sleep stage characteristics of long and short sleepers. *Science* 1970 Apr 3;168(3927):146-147.

- [92] Purves D, Augustine G, Fitzpatrick D. *Physiological Changes in Sleep States*. Second Edition. Washington, DC, USA: Neuroscience; 2001.
- [93] Suzuki T, Tanaka H, Minami S. Wearable Wireless Vital Monitoring Technology for Smart Health Care. In: 7th International Symposium on Medical Information and Communication Technology. 2013 Presented at: ISMICT'13; March 6-8, 2013; Tokyo, Japan.
- [94] Chan AM, Selvaraj N, Ferdosi N. Wireless Patch Sensor for Remote Monitoring of Heart Rate, Respiration, Activity, and Falls. In: 35th Annual International Conference of the IEEE Engineering in Medicine and Biology Society. 2013 Presented at: EMBC'13; July 3-7, 2013; Osaka, Japan.
- [95] Sadek I, Seet E, Biswas J, Abdulrazak B, Mokhtari M. Nonintrusive vital signs monitoring for sleep apnea patients: a preliminary study. *IEEE Access* 2018;6:2506-2514.
- [96] Sadek I, Biswas J, Abdulrazak B. Continuous and Unconstrained Vital Signs Monitoring With Ballistocardiogram Sensors in Headrest Position. In: International Conference on Biomedical & Health Informatics. 2017 Presented at: BHI'17; February 16-19, 2017; Orlando, Florida, USA.
- [97] Seba A, Istrate D, Guettari T, Ugon A, Pinna A, Garda P. Thermal-signature-based sleep analysis sensor. *Informatics* 2017 Oct 28;4(4):37.
- [98] Sadek I, Biswas J, Yongwei Z. Sensor Data Quality Processing for Vital Signs With Opportunistic Ambient Sensing. In: 38th Annual International Conference of the IEEE Engineering in Medicine and Biology Society. 2016 Presented at: EMBC'16; August 16-20, 2016; Orlando, FL, USA.
- [99] Lee WK, Yoon H, Park KS. Smart ECG monitoring patch with built-in R-peak detection for long-term HRV analysis. *Ann Biomed Eng* 2016 Jul;44(7):2292-2301.
- [100] Samy L, Huang M, Liu JJ, Xu W, Sarrafzadeh M. Unobtrusive sleep stage identification using a pressure-sensitive bed sheet. *IEEE Sensors J* 2014 Jul;14(7):2092-2101.
- [101] Lee L, Lo Y, Yu J, Lee G, Ni Y, Chen N, et al. Snoring sounds predict obstruction sites and surgical response in patients with obstructive sleep apnea hypopnea syndrome. *Sci Rep* 2016 Jul 29;6:30629.
- [102] Hou L, Wang C, Zhang C. Calculating AHI Combine Oximetry and Snore Sound. In: China Summit and International Conference on Signal and Information Processing. 2015 Presented at: ChinaSIP'15; July 12-15, 2015; Chengdu, China.
- [103] Emoto T, Abeyratne UR, Kawano K, Okada T, Jinnouchi O, Kawata I. Detection of sleep breathing sound based on artificial neural network analysis. *Biomed Signal Proces* 2018 Mar;41:81-89.
- [104] Sadek I, Biswas J, Fook VF. Automatic Heart Rate Detection From FBG Sensors Using Sensor Fusion and Enhanced Empirical Mode Decomposition. In: International Symposium on Signal Processing and Information Technology. 2015 Presented at: ISSPIT'15; December 7-19, 2015; Abu Dhabi, United Arab Emirates.
- [105] Beattie Z, Oyang Y, Statan A, Ghoreyshi A, Pantelopoulos A, Russell A, et al. Estimation of sleep stages in a healthy adult population from optical plethysmography and accelerometer signals. *Physiol Meas* 2017 Oct 31;38(11):1968-1979.

- [106] Huang NE, Shen Z, Long SR, Wu MC, Shih HH, Zheng Q, et al. The empirical mode decomposition and the Hilbert spectrum for nonlinear and non-stationary time series analysis. *Proc R Soc Lond A* 1998 Mar 8;454(1971):903-995.
- [107] Charleston-Villalobos S, González-Camarena R, Chi-Lem G, Aljama-Corrales T. Crackle sounds analysis by empirical mode decomposition. *Nonlinear and nonstationary signal analysis for distinction of crackles in lung sounds. IEEE Eng Med Biol Mag* 2007;26(1):40-47.
- [108] Balocchi R, Menicucci D, Santarcangelo E, Sebastiani L, Gemignani A, Ghelarducci B, et al. Deriving the respiratory sinus arrhythmia from the heartbeat time series using empirical mode decomposition. *Chaos Soliton Fract* 2004 Apr;20(1):171-177.
- [109] Van Marken Lichtenbelt WD, Daanen HA, Wouters L, Fronczek R, Raymann RJ, Severens NM, et al. Evaluation of wireless determination of skin temperature using iButtons. *Physiol Behav* 2006 Jul 30;88(4-5):489-497.
- [110] Van Someren EJ. Mechanisms and functions of coupling between sleep and temperature rhythms. *Prog Brain Res* 2006;153:309-324.
- [111] Kräuchi K, Deboer T. Body temperatures, sleep, and hibernation. *Principl Pract Sleep Med* 2011:323-334.
- [112] Keogh E, Lin J, Lee SH, Herle H. Finding the most unusual time series subsequence: algorithms and applications. *Knowl Inf Syst* 2006 Nov 23;11(1):1-27.
- [113] van Hulle MM. Self-organizing maps. In: *Handbook of Natural Computing*. Berlin, Heidelberg: Springer; 2012:585-622.
- [114] Lafferty J, McCallum A, Pereira FC. Conditional Random Fields: Probabilistic Models for Segmenting and Labeling Sequence Data. University of Pennsylvania ScholarlyCommons. 2001. URL: https://repository.upenn.edu/cgi/viewcontent.cgi?article=1162&context=cis_papers [accessed 2020-08-13]
- [115] Schuster-Böckler B, Bateman A. An introduction to hidden Markov models. *Curr Protoc Bioinformatics* 2007 Jun;Appendix 3:Appendix 3A.
- [116] Zeo Sleep Manager Pro: Usage Tips. Gibson Research Corporation. 2016. URL: <https://www.grc.com/zeo.htm> [accessed 2016-05-10]
- [117] Carpenter JS, Andrykowski MA. Psychometric evaluation of the Pittsburgh sleep quality index. *J Psychosom Res* 1998 Jul;45(1):5-13.
- [118] Krishna A, Mallick M, Mitra B. SleepSensei: An Automated Sleep Quality Monitor and Sleep Duration Estimator. In: *Proceedings of the First Workshop on IoT-enabled Healthcare and Wellness Technologies and Systems*. 2016 Presented at: IoT of Health'16; June 25-30, 2016; Singapore,.
- [119] Nochino T, Ohno Y, Kato T, et al. Sleep stage estimation method using a camera for home use. *Biomedical engineering letters*, 2019, 9(2): 257-265.
- [120] Kim J Y, Chu C H, Kang M S. IoT based Unobtrusive Sensing for Sleep Quality Monitoring and Assessment. *IEEE Sensors Journal*, 2020.

- [121] Chang X, Peng C, Xing G, et al. iSleep: A Smartphone System for Unobtrusive Sleep Quality Monitoring. *ACM Transactions on Sensor Networks (TOSN)*, 2020, 16(3): 1-32.
- [122] Kay M, Choe EK, Shepherd J. Lullaby: a Capture & Access System for Understanding the Sleep Environment. In: *Proceedings of the 2012 ACM Conference on Ubiquitous Computing*. 2012 Presented at: UbiComp'12; September 5-8, 2012; Pittsburgh, USA.
- [123] <https://www.bluetooth.com/bluetooth-resources/intro-to-bluetooth-low-energy/>
- [124] <https://lora-alliance.org/>
- [125] <https://www.wi-fi.org/>
- [126] https://en.wikipedia.org/wiki/Narrowband_IoT
- [127] <https://www.sigfox.com/en>
- [128] <https://zigbeealliance.org/>
- [129] Charlon Y. Conception de dispositifs électroniques portés pour le suivi de l'état de santé des personnes âgées, Toulouse, LAAS-CNRS, 2014.
- [130] Buysse, D. J., Reynolds III, C. F., Monk, T. H., Berman, S. R., & Kupfer, D. J. (1989). The Pittsburgh Sleep Quality Index: a new instrument for psychiatric practice and research. *Psychiatry research*, 28(2), 193-213.
- [131] Daskalova N, Lee B, Huang J, et al. Investigating the effectiveness of cohort-based sleep recommendations. *Proceedings of the ACM on Interactive, Mobile, Wearable and Ubiquitous Technologies*, 2018, 2(3): 1-19.
- [132] Arbinaga F, Tornero-Quiñones I, Fernández-Ozcorta E. Sleeping Position, Expression of Anger and Subjective Sleep Quality in University Students. *Sleep and Hypnosis (Online)*, 2018, 20(4): 267-274.
- [133] Ravesloot M J L, Van Maanen J P, Dun L, et al. The undervalued potential of positional therapy in position-dependent snoring and obstructive sleep apnea—a review of the literature. *Sleep and Breathing*, 2013, 17(1): 39-49.
- [134] Shetty M, Mador M J. Prevalence of Positional Obstructive Sleep Apnea in Patients Undergoing Polysomnography and the Effect of Sleep Stage//Positional Therapy in Obstructive Sleep Apnea. Springer, Cham, 2015: 53-64.
- [135] Mendonça F, Mostafa S S, Morgado-Dias F, et al. A review of approaches for sleep quality analysis. *Ieee Access*, 2019, 7: 24527-24546.
- [136] Walters AS International Restless Legs Study Group. (1995). Toward a better definition of the restless legs syndrome. *Mov Disord*, 10, 634-42.
- [137] Gubin D G, Weinert D, Rybina S V, et al. Activity, sleep and ambient light have a different impact on circadian blood pressure, heart rate and body temperature rhythms. *Chronobiology international*, 2017, 34(5): 632-649.
- [138] Lewy A J, Wehr T A, Goodwin F K, et al. Light suppresses melatonin secretion in humans. *Science*, 1980, 210(4475): 1267-1269.

- [139] Auld F, Maschauer E L, Morrison I, et al. Evidence for the efficacy of melatonin in the treatment of primary adult sleep disorders. *Sleep Medicine Reviews*, 2017, 34: 10-22.
- [140] Faraone S V. ADHD: Non-Pharmacologic Interventions, An Issue of Child and Adolescent Psychiatric Clinics of North America, E-Book. Elsevier Health Sciences, 2014.
- [141] Gilbert, S. S., van den Heuvel, C. J., Ferguson, S. A., & Dawson, D. (2004). Thermoregulation as a sleep signalling system. *Sleep medicine reviews*, 8(2), 81-93.
- [142] <https://play.google.com/store/apps/details?id=com.bruxlabsnore&hl=fr>
- [143] Zucconi M, Ferri R, Allen R, et al. The official World Association of Sleep Medicine (WASM) standards for recording and scoring periodic leg movements in sleep (PLMS) and wakefulness (PLMW) developed in collaboration with a task force from the International Restless Legs Syndrome Study Group (IRLSSG). *Sleep Med* 2006;7(2):175-183.
- [144] Michaud M, Paquet J, Lavigne G, et al. Sleep laboratory diagnosis of restless legs syndrome. *Eur Neurol* 2002;48:108-113.
- [145] Coleman RM. Periodic movements in sleep (nocturnal myoclonus) and restless legs syndrome. In: Guilleminault C, editor. *Sleeping and waking disorders: indications and techniques*. Menlo Park, CA: Addison–Wesley; 1982. p. 265-295.
- [146] Sewitch D E, Kittrell E M W, Kupfer D J, et al. Body temperature and sleep architecture in response to a mild cold stress in women. *Physiology & behavior*, 1986, 36(5): 951-957.
- [147] Fletcher A, Heuvel C, Dawson D. Sleeping with an electric blanket: effects on core temperature, sleep, and melatonin in young adults. *Sleep*, 1999, 22(3): 313-318.
- [148] Rahman S A, Flynn-Evans E E, Aeschbach D, et al. Diurnal spectral sensitivity of the acute alerting effects of light. *Sleep*, 2014, 37(2): 271-281.
- [149] Chang A M, Aeschbach D, Duffy J F, et al. Evening use of light-emitting eReaders negatively affects sleep, circadian timing, and next-morning alertness. *Proceedings of the National Academy of Sciences*, 2015, 112(4): 1232-1237.
- [150] Xu D, Tian Y. A comprehensive survey of clustering algorithms. *Annals of Data Science*, 2015, 2(2): 165-193.
- [151] Rechtschaffen A. A manual of standardized terminology, technique and scoring system for sleep stages of human subjects. Public Health Service, 1968.
- [152] Acebo C, LeBourgeois M K. Actigraphy. *Respiratory care clinics of North America*, 2006, 12(1): 23.
- [153] Pollak C P, Tryon W W, Nagaraja H, et al. How accurately does wrist actigraphy identify the states of sleep and wakefulness? *Sleep*, 2001, 24(8): 957-965.
- [154] Carskadon M A, Dement W C. Normal human sleep: an overview. *Principles and practice of sleep medicine*, 2005, 4: 13-23.
- [155] MacQueen J. Some methods for classification and analysis of multivariate observations//Proceedings of the fifth Berkeley symposium on mathematical statistics and probability. 1967, 1(14): 281-297.

- [156] Diykh M, Li Y, Wen P. EEG sleep stages classification based on time domain features and structural graph similarity. *IEEE Transactions on Neural Systems and Rehabilitation Engineering*, 2016, 24(11): 1159-1168.
- [157] Van Hese P, Philips W, De Koninck J, et al. Automatic detection of sleep stages using the EEG//2001 conference proceedings of the 23rd annual international conference of the IEEE engineering in medicine and biology society. *IEEE*, 2001, 2: 1944-1947.
- [158] Güneş S, Polat K, Yosunkaya Ş. Efficient sleep stage recognition system based on EEG signal using k-means clustering based feature weighting. *Expert Systems with Applications*, 2010, 37(12): 7922-7928.
- [159] de Zambotti M, Goldstone A, Claudatos S, et al. A validation study of Fitbit Charge 2™ compared with polysomnography in adults. *Chronobiology international*, 2018, 35(4): 465-476.
- [160] Brand S, Gerber M, Kalak N, et al. Adolescents with greater mental toughness show higher sleep efficiency, more deep sleep and fewer awakenings after sleep onset. *Journal of Adolescent Health*, 2014, 54(1): 109-113.
- [161] Hirshkowitz M, Whiton K, Albert S M, et al. National Sleep Foundation's sleep time duration recommendations: methodology and results summary. *Sleep health*, 2015, 1(1): 40-43.
- [162] Buboltz Jr W, Jenkins S M, Soper B, et al. Sleep habits and patterns of college students: an expanded study. *Journal of College Counseling*, 2009, 12(2): 113-124.
- [163] <https://www.withings.com/fr/fr/sleep-analyzer>
- [164] Wasserstein R L, Lazar N A. The ASA statement on p-values: context, process, and purpose. 2016.
- [165] Di Leo G, Sardanelli F. Statistical significance: p value, 0.05 threshold, and applications to radiomics—reasons for a conservative approach. *European Radiology Experimental*, 2020, 4(1): 1-8. Van der Geer J, Hanraads JAJ, Lupton RA. The art of writing a scientific article. *J Sci Commun* 2000;163:51-9.
- [166] Landis, J. R., Koch, G. G. The measurement of observer agreement for categorical data. *biometrics*, 1977, 159-174.
- [167] <https://online.stat.psu.edu/stat509/node/162/>
- [168] Chiaro G, Manconi M. Restless legs syndrome, periodic limb movements during sleep and cardiovascular risk. *Autonomic Neuroscience*, 2019, 220: 102554.
- [169] Montplaisir J, Boucher S, Gaétan Poirier, et al. Clinical, polysomnographic, and genetic characteristics of restless legs syndrome: A study of 133 patients diagnosed with new standard criteria. *Movement Disorders*, 1997, 12(1):61-65.
- [170] Hening W. The clinical neurophysiology of the restless legs syndrome and periodic limb movements. Part I: diagnosis, assessment, and characterization. *Clinical Neurophysiology*, 2004, 115(9): 1965-1974.
- [171] Allen R P, Earley C J. Restless legs syndrome: a review of clinical and pathophysiologic features. *Journal of Clinical Neurophysiology*, 2001, 18(2): 128-147.
- [172] Garcia-Borreguero D, Larrosa O, de la Llave Y, et al. Correlation between rating scales and sleep laboratory measurements in restless legs syndrome. *Sleep medicine*, 2004, 5(6): 561-565.

- [173] Aksu M, Demirci S, Bara-Jimenez W. Correlation between putative indicators of primary restless legs syndrome severity. *Sleep medicine*, 2007, 8(1): 84-89.

List of Publications

Journals:

1. Pan Q., Brulin D., Campo E. Current Status and Future Challenges of Sleep Monitoring Systems: Systematic Review. *JMIR Biomedical Engineering*, 2020, 5(1): e20921.
2. Zitouni M., Pan Q., Brulin D., et al. Design of a Smart Sole with Advanced Fall Detection Algorithm. *Journal of Sensor Technology*, 2019, 9(04): 71.
3. Pan Q., Brulin D., Campo E. Wrist movement analysis for long-term home sleep monitoring. *Expert Systems With Applications*. Dec. 2020. *Under revision*.

International conferences:

1. Pan Q., Brulin D., Campo E. Home sleep monitoring based on wrist movement data processing//10th International Conference of Information and Communication Technology (ICICT-2020). November 13-15th, 2020. *Best paper award*.

National conferences:

1. Pan Q., Campo E., Brulin D. Smart device for long-term sleep monitoring at home. 21^{ème} édition des Journées Nationales du Réseau Doctoral en Micro-nanoélectronique (JNRDM), Jun 2019, Montpellier, France. 2019.
2. Pan Q. In-home sleep monitoring based on wrist movement. Doctoral school event GEET, Toulouse, May 2020.