



HAL
open science

Contributions on stabilization of switched affine systems

Mathias Serieye

► **To cite this version:**

Mathias Serieye. Contributions on stabilization of switched affine systems. Automatic Control Engineering. UPS, 2021. English. NNT: . tel-03590909v1

HAL Id: tel-03590909

<https://laas.hal.science/tel-03590909v1>

Submitted on 28 Feb 2022 (v1), last revised 10 May 2022 (v2)

HAL is a multi-disciplinary open access archive for the deposit and dissemination of scientific research documents, whether they are published or not. The documents may come from teaching and research institutions in France or abroad, or from public or private research centers.

L'archive ouverte pluridisciplinaire **HAL**, est destinée au dépôt et à la diffusion de documents scientifiques de niveau recherche, publiés ou non, émanant des établissements d'enseignement et de recherche français ou étrangers, des laboratoires publics ou privés.



THÈSE

En vue de l'obtention du DOCTORAT DE L'UNIVERSITÉ DE TOULOUSE

Délivré par l'Université Toulouse 3 - Paul Sabatier

Présentée et soutenue par

Mathias SERIEYE

Le 13 décembre 2021

**Contributions à la stabilisation des systèmes à commutation
affine**

Ecole doctorale : **SYSTEMES**

Spécialité : **Automatique**

Unité de recherche :

LAAS - Laboratoire d'Analyse et d'Architecture des Systèmes

Thèse dirigée par

Alexandre SEURET et Carolina ALBEA SANCHEZ

Jury

M. Christophe PRIEUR, Rapporteur

M. Laurentiu HETEL, Rapporteur

M. Francesco FERRANTE, Examineur

M. Alexandre SEURET, Directeur de thèse

Mme Carolina ALBEA SANCHEZ, Co-directrice de thèse

M. Marc JUNGERS, Président

Université de Toulouse

Université Paul Sabatier

Contributions on stabilization of switched affine systems

A Dissertation submitted in partial satisfaction of the requirements for the degree of

Doctor of Philosophy

in

Control Theory

by

Mathias Serieye

December 2021

Remerciements

Par dessus tout, je souhaite remercier Carolina et Alexandre qui m'ont offert l'opportunité de faire une thèse. Tout au long de ces 3 années, ils m'ont soutenu, encouragé, guidé (voire recadré lorsque je me perdais) toujours avec grande pédagogie, et ce malgré la situation et la distance. C'est notamment grâce à eux que j'aime autant la recherche et pour cette raison, je regrette d'avoir été si loin d'eux tant de temps à cause de la Covid – mes meilleurs souvenirs sont ceux de la première année avec la période à Séville pour summum. Je pense aussi à Marc Jungers qui aura finalement été comme un 3^{ième} encadrant et avec qui j'aurais beaucoup aimé poursuivre mes recherches.

Merci à tous les membres du jury d'avoir accepté mon invitation, en particulier Christophe Prieur et Laurentiu Hetel d'avoir bien voulu être rapporteur de ma thèse, d'autant plus que leurs rapports et leurs commentaires m'ont touché à un moment de doute face à mon travail. J'ai beaucoup apprécié les commentaires et le rapport de soutenance donnés par Laurentiu, Christophe, Marc et Francesco Ferrante ; leurs compliments m'ont mis du baume au coeur.

Je remercie de manière générale tous les profs de l'université, je pense à Yann Labit pour mon premier stage au LAAS, à Pauline Ribot, Euriell Le Corronc, Sylvain Durola et Frédéric Gouaisbaut pendant mes années de Master qui m'ont amené jusqu'à la thèse. Je tiens à dire merci à Soheib Fergani et Pierre Vuillemin qui ont bien joué leur rôle en tant que comité de suivi, ils ont toujours eu de bon conseil, de manière sérieuse et amicale. Et un dernier merci à Alexandre pour toutes ces années depuis mon stage, encadrant qui sera devenu une figure paternelle à mes yeux.

Merci à l'équipe MAC qui aura gardé mon bureau au chaud (oui désolé, on gère le stress de la pandémie comme on peut). Plus sérieusement, j'estime être très chanceux d'avoir pu faire parti de votre équipe, j'ai toujours apprécié voir la bonne ambiance qu'il y a au sein des bureaux. Merci Matthieu, Flavien, Mathieu, Adrien, Yoni pour les moments passés avec vous.

Je remercie mes amis (Alice, YaYa, Manon, Grogui) avec qui j'aurais passé mes plus belles vacances de thèse et les plus beaux apéros au Four Monkeys ; merci à mes colocataires Benoît et Rita, merci pour tous ces moments si simples du quotidien mais qui comptent pour moi ; merci à mes meilleurs amis (Guillaume, Franck, Pilou, Théo, Séb, Antoine, Rémi) et mon meilleur cousin Thibaud, tous les piliers de ma vie ; merci à ma copine Manon, pour toutes ces randonnées et pour toutes ces soirées jeux, merci notamment d'avoir fait venir mes parents jusqu'à Toulouse pour ma soutenance ; merci à eux d'être venu, merci d'être les parents que tout le monde souhaiterait avoir et enfin merci au reste de ma famille pour tout le soutien.

A Lily

Abstract

This thesis deals with the stabilization of switched affine systems with a periodic sampled-data switching control. The particularities of this class of nonlinear systems are first related to the fact that the control action is performed at the computation times by selecting the switching mode to be activated and, second, to the problem of providing an accurate characterization of the set where the solutions to the system converge to, *i.e.* the attractors. The contributions reported in this thesis have as common thread to reduce the conservatism made in the characterization of attractors, leading to guarantee the stabilization of the system at a limit cycle.

After a brief introduction presenting the context and some main results, the first contributive chapter introduced a new method based on a new class of control Lyapunov functions that provides a more accurate characterization of the invariant set for a closed-loop system. The contribution presented as a non convex optimization problem and referring to a Lyapunov-Metzler condition appears to be a preliminary result and the milestone of the forthcoming chapters.

The second part deals with the stabilization of switched affine systems to limit cycles. After presenting some preliminaries on hybrid limit cycles and derived notions such as cycles in Chapter 3, stabilizing switching control laws are developed in Chapter 4. A control Lyapunov approach and a min-switching strategy are used to guarantee that the solutions to a nominal closed-loop system converge to a limit cycle. The conditions of the theorem are expressed in terms of simple linear matrix inequalities (LMI), whose underlying necessary conditions relax the usual one in this literature. This method is then extended to the case of uncertain systems in Chapter 5, for which the notion of limit cycle needs to be adapted. Finally, the hybrid dynamical system framework is explored in Chapter 6 and the attractors are no longer characterized by possibly disjoint regions but as continuous-time closed and isolated trajectory. All along the dissertation, the theoretical results are evaluated on academic examples and demonstrate the potential of the method over the recent literature on this subject.

Keywords: Switched systems, hybrid systems, switching control, limit cycles, Lyapunov stability, Linear Matrix Inequality.

Résumé

Cette thèse porte sur la stabilisation des systèmes à commutation dont la commande, le signal de commutation, est échantillonnée de manière périodique. Les difficultés liées à cette classe de systèmes non linéaires sont d'abord dues au fait que l'action de contrôle est effectuée aux instants de calcul en sélectionnant le mode de commutation à activer et, ensuite, au problème de fournir une caractérisation précise de l'ensemble vers lequel convergent les solutions du système, c'est-à-dire l'attracteur. Dans cette thèse, les contributions ont pour fil conducteur la réduction du conservatisme fait pendant la définition d'attracteurs, ce qui a mené à garantir la stabilisation du système à un cycle limite.

Après une introduction générale où sont présentés le contexte et les principaux résultats de la littérature, le premier chapitre contributif introduit une nouvelle méthode basée sur une nouvelle classe de fonctions de Lyapunov contrôlées qui fournit une caractérisation plus précise des ensembles invariants pour les systèmes en boucle fermée. La contribution présentée comme un problème d'optimisation non convexe et faisant référence à une condition de Lyapunov-Metzler apparaît comme un résultat préliminaire et une étape clé pour les chapitres à suivre.

La deuxième partie traite de la stabilisation des systèmes affines commutés vers des cycles limites. Après avoir présenté quelques préliminaires sur les cycles limites hybrides et les notions dérivées telles que les cycles au Chapitre 3, les lois de commutation stabilisantes sont introduites dans le Chapitre 4. Une approche par fonctions de Lyapunov contrôlées et une stratégie de *min-switching* sont utilisées pour garantir que les solutions du système nominal en boucle fermée convergent vers un cycle limite. Les conditions du théorème sont exprimées en termes d'Inégalités Matricielles Linéaires (dont l'abréviation anglaise est LMI) simples, dont les conditions nécessaires sous-jacentes relâchent les conditions habituelles dans cette littérature. Cette méthode est étendue au cas des systèmes incertains dans le Chapitre 5, pour lesquels la notion de cycles limites doit être adaptée. Enfin, le cas des systèmes dynamiques hybrides est exploré au Chapitre 6 et les attracteurs ne sont plus caractérisés par des régions éventuellement disjointes mais par des trajectoires fermées et isolées en temps continu. Tout au long de la thèse, les résultats théoriques sont évalués sur des exemples académiques et démontrent le potentiel de la méthode par rapport à la littérature récente sur le sujet.

Mots clés: Systèmes à commutation, systèmes hybrides, loi de commutation, cycle limite, stabilité de Lyapunov, Inégalité Matricielle Linéaire.

Contents

Remerciements	i
Abstract	v
Résumé	vii
List of Figures	xi
List of Tables	xiii
Notation	xv
1 Introduction	1
1.1 Motivation: Example of power converters	1
1.2 Overview of the literature	3
1.3 Problem statement and contributions	14
1.4 Organization of the manuscript	16
1.5 List of publications	16
2 Practical stabilization	19
2.1 Problem formulation	19
2.2 Switching rule design	20
2.3 Discussions regarding the main result	24
2.4 Examples	27
2.5 Conclusion	30
3 Introduction to limit cycles	33
3.1 Overview of the literature	33
3.2 Limit cycles of switched systems	36
3.3 Particular case of switched affine systems	41
3.4 Discussion on cycles	45
3.5 Conclusion	48
4 Stabilization to limit cycles	49
4.1 Introduction	49
4.2 Design of the switching rules	49
4.3 Discussions regarding the main result	55
4.4 Optimization	58
4.5 Examples	59
4.6 Conclusion	63
5 Robust stabilization to limit cycles	65
5.1 Motivation	65
5.2 Design of the switching rule	66
5.3 Discussions regarding the main result	70

5.4	Optimization	72
5.5	Example	74
5.6	Conclusion	76
6	Stabilization to limit cycles: the Hybrid Dynamical Systems formalism	77
6.1	Hybrid Dynamical Systems framework	77
6.2	Sampled-data switched affine model	81
6.3	Limit cycles of switched affine systems	83
6.4	Problem formulation	86
6.5	Design of the hybrid switching rule	86
6.6	Optimization	90
6.7	Examples	91
6.8	Conclusion	95
7	Conclusion & Perspectives	97
7.1	General conclusion	97
7.2	Perspectives	98
A	Useful properties on matrix inequalities	103
A.1	Schur complement	103
A.2	S-procedure	104
B	Appendix to Chapter 3	105
B.1	Details on the monodromy matrix	105

List of Figures

1.1	Illustration of a DC-DC boost converter connected to a resistive load.	2
1.2	Illustration of a DC-DC boost converter: two cases	3
1.3	Evolution of the state variables represented in the state space.	6
1.4	Figure extracted from [33]	13
2.1	Trajectories of system (2.1) in the state space (Example 1).	28
2.2	Evolution of $x(k) - \zeta_{\sigma(k)}$ and the switching signal (Example 1)	29
2.3	Trajectories of system (2.1) in the state space (Example 2).	30
2.4	Evolution of the Lyapunov function $V(x(k))$ for Example 2.	30
3.1	Different cases of limit cycle's stability [95]	33
3.2	Comparative illustrations of periodic trajectories and isolated ones.	35
3.3	Illustration of a periodic trajectory crossing itself	41
3.4	Schematic representation of a limit cycle	43
3.5	Illustration of Corollary 3.1	46
3.6	Illustration of Corollary 3.2	47
4.1	Evolution of the state variables for three different cycles (Example 1)	60
4.2	Illustration of the comparison with the results from [36].	62
4.3	Evolution of the distance to the attractor $d_{\mathcal{A}_\nu}(x(k))$ (Example 2).	62
4.4	State-space partition $\theta(x)$ (Example 3).	63
4.5	State-space partition $\sigma(x)$ and switching signal (Example 3).	64
5.1	Schematic representation of a robust limit cycle	66
5.2	Growth of the attractor's size	75
5.3	Trajectories of uncertain system (5.28)-(5.29)	76
6.1	Attractor comparison (Example 1).	91
6.2	Illustration of the max absolute characteristic multiplier (Example 1).	92
6.3	Evolution of the state in the phase plan (Example 2).	93
6.4	Schematic of a three-cell converter (Example 3).	94
6.5	State evolution in different view (Example 3).	95
6.6	State evolution function of the time (Example 3).	95

List of Tables

- 4.1 Cycles, state limit cycles and optimal cost (Example 1). 59
- 6.1 Converter parameters and switching states (Example 3). 96
- 7.1 Expressions of the attractors obtained in various cases. 99

Notation

This section provides the notations used all along the thesis.

- \mathbb{N} : set of positive integers,
- $\mathbb{R}^+ = \{x \in \mathbb{R} \mid x \geq 0\}$,
- \mathbb{K} : index set of switched systems,
- \mathcal{C} : flow set for Hybrid Dynamical Systems,
- \mathcal{D} : jump set for Hybrid Dynamical Systems,
- $\mathbb{R}^{n \times m}$: set of real matrices with n rows and m columns,
- \mathbb{S}^n : set of real symmetric matrices with n rows,
- \mathbb{S}_+^n : set of symmetric definite positive matrices, $M \in \mathbb{S}_+^n \Leftrightarrow M \succ 0$,
- $M \preceq 0 \Leftrightarrow -M \succeq 0$ and $M \prec 0 \Leftrightarrow -M \succ 0$,
- $I_n \in \mathbb{R}^{n \times n}$: identity matrix,
- $0_{n,m}$: null matrix of $\mathbb{R}^{n \times m}$ and $0_n = 0_{n,n}$,
- M^\top : transposition of a matrix M ,
- $\text{He}(M) = M + M^\top$,
- $\text{eig}_i(M)$: i -th eigenvalue of matrix M ,
- $v \in \mathbb{R}^n$: a real vector with n rows.
- Let $\mathcal{S} \subset \mathbb{R}^n$ be a finite set of vectors. The minimum argument of a given function $f : \mathcal{S} \rightarrow \mathbb{R}$ is noted by $\arg \min_{x \in \mathcal{S}} f(x) = \{y \in \mathcal{S} : f(y) \leq f(z), \forall z \in \mathcal{S}\}$
- Let $\{M^\ell\}_{\ell=1,\dots,L}$ be a set of L homogeneous matrices; $\text{Co}\left(M^\ell\right)_{\ell=1,\dots,L}$ denotes its convex hull.

Abbreviations

- AC: Alternating Current
- BMI: Bilinear Matrix Inequality
- DC: Direct Current
- HDS: Hybrid Dynamical System
- LMI: Linear Matrix Inequality

1

Introduction

In control theory, the objective concerns generally the study of dynamical systems and the design of a controller that would dictate how they should behave. Generally, they are classified as either continuous-time dynamical systems, whether the evolution of the state can be represented by a continuous function, or discrete-time dynamical systems, whether difference equations are employed to describe the dynamic. Numerous systems escape this classification and are better represented by the combination of both continuous and discrete dynamics. Such systems are usually called *hybrid* systems [50]. This thesis deals with the stabilization of switched affine systems which belong to that last category of dynamical systems. The next section shows an example of switched affine systems by introducing the mathematical modeling of the switched power converter known as DC-DC boost converter.

1.1 Motivation: Example of power converters

Power converters are present in many systems such as electronic devices, power supplies, aircraft and automobile industries, photovoltaic installations, among others [29, 81]. This kind of systems needs to be managed by suitable control laws in order to increase their efficiency and reliability in their process of electric power transformation.

As commented above, the natural representation of some systems is a hybrid model that collects both continuous and discrete time dynamics. This is the case of switched power converters which are composed of some functioning modes and a logical rule that selects the mode to be activated among the possible ones [68]. More precisely, the voltages and currents are continuous-time variables, while the transistors, which allow the selection of mode, evolve at some discrete instants of time.

In this section, we introduced a DC-DC converter known as boost converter. Boost converter is one of the four classic topologies of DC-DC converters along with buck, buck-boost and Ćuk converters [29]. While all DC-DC converters can convert a DC voltage input level to another, boost converters are able to generate an output voltage larger than the input one. Hence, it is possible to find DC-DC boost converters in photovoltaic (PV) systems for instance [1, 41], where the DC source comes from the PV module. The electric circuit of a step-up converter is illustrated on Figure 1.1, the input tension V_{in} represents the voltage from a source such as a PV array or a battery. Details on the functioning principle are given thereafter.

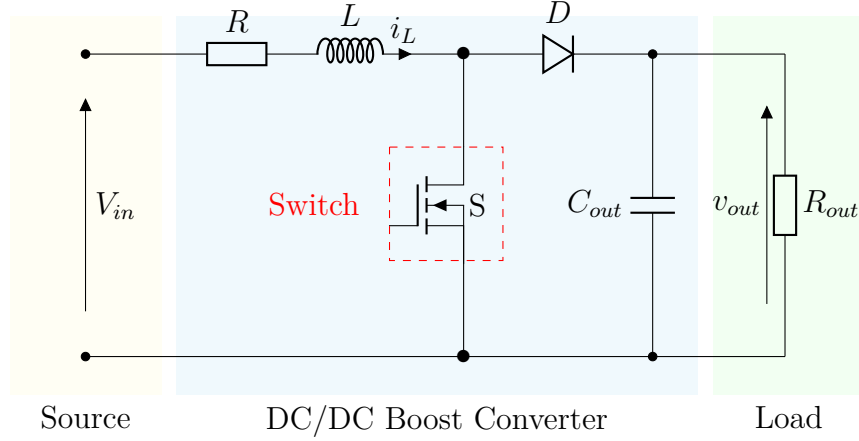

Figure 1.1: Illustration of a DC-DC boost converter connected to a resistive load.

Figure 1.1 depicts the converter which is composed of an inductor L (associated with an dissipative resistance R), a diode D and a filter capacitor C_{out} along with the transistor S that can switch and therefore, induce different dynamic depending on its state. When the switch S is in the *on* state, the diode is *off* and the current in the inductor increases at this time while the condensator discharges on the resistance load R_{out} . In this configuration, we can model the system illustrated on Figure 1.2a and then derive the following state-space representation from the Kirchoff's laws

$$\frac{d}{dt} \begin{bmatrix} i_L(t) \\ v_{out}(t) \end{bmatrix} = \begin{bmatrix} -\frac{R}{L} & 0 \\ 0 & -\frac{1}{R_{out}C_{out}} \end{bmatrix} \begin{bmatrix} i_L(t) \\ v_{out}(t) \end{bmatrix} + \begin{bmatrix} \frac{V_{in}}{L} \\ 0 \end{bmatrix}, \quad (1.1)$$

where the inductor current $i_L(t)$ and the capacitor voltage $v_{out}(t)$ represent the continuous-time dynamic of the system. The second configuration corresponds to the case when the switch is *off*, see Figure 1.2b. In this situation, the initial energy stored in the inductor together with the energy provided by the input feeds the capacitor and the load. The diode becomes equivalent to a simple wire and thus lets the inductance current go through. Applying the Kirchoff's law to the model on Figure 1.2b yields to the following differential matrix equation

$$\frac{d}{dt} \begin{bmatrix} i_L(t) \\ v_{out}(t) \end{bmatrix} = \begin{bmatrix} -\frac{R}{L} & -\frac{1}{L} \\ \frac{1}{C_{out}} & -\frac{1}{R_{out}C_{out}} \end{bmatrix} \begin{bmatrix} i_L(t) \\ v_{out}(t) \end{bmatrix} + \begin{bmatrix} \frac{V_{in}}{L} \\ 0 \end{bmatrix}. \quad (1.2)$$

It is then quite easy to notice that the models (1.1) and (1.2) have some similarities and can be written in a unique model which depends on the state of the switch S which is assumed to correspond to the value S : $u = 1$ when the transistor is turned *on* and to

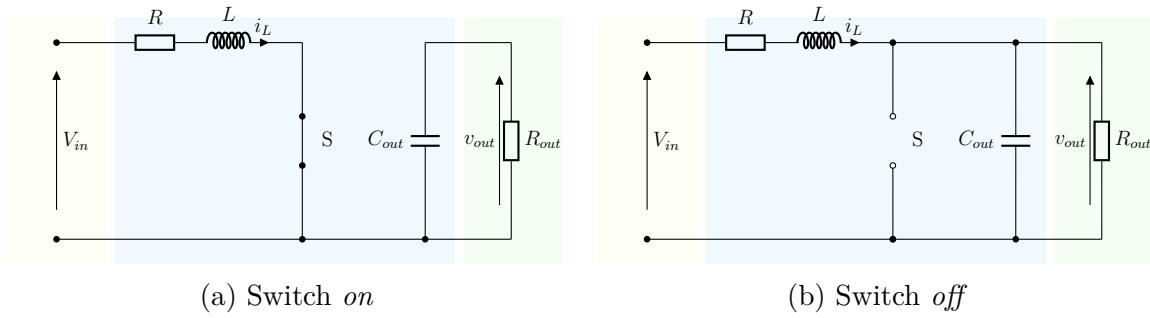

Figure 1.2: Illustration of a DC-DC boost converter: two different functioning modes

the value S : $u = 0$ when the transistor is turned *off*. The compact form is given by

$$\left\{ \begin{array}{l} \frac{d}{dt} \begin{bmatrix} i_L(t) \\ v_{out}(t) \end{bmatrix} = \begin{bmatrix} -\frac{R}{L} & -\frac{1-u}{L} \\ \frac{1-u}{C_{out}} & -\frac{1}{R_{out}C_{out}} \end{bmatrix} \begin{bmatrix} i_L(t) \\ v_{out}(t) \end{bmatrix} + \begin{bmatrix} \frac{V_{in}}{L} \\ 0 \end{bmatrix}, \\ u \in \{0, 1\}. \end{array} \right. \quad (1.3)$$

This last system introduces an example of a dynamical system, the DC-DC converter, that combines continuous-time and discrete-time dynamics. More particularly, the matrix differential equation (1.3) represents the dynamic of switched affine systems given by

$$\left\{ \begin{array}{l} \dot{x}(t) = F_{\sigma(t)}x(t) + g_{\sigma(t)}, \quad t \in \mathbb{R}^+ \\ \sigma(t) = u(t) \in \{0, 1\}, \end{array} \right.$$

where $x(t) \in \mathbb{R}^n$ is the state and gathers the current $i_L(t)$ and the voltage $v_{out}(t)$ of the converter. The function $\sigma(t)$ is the switching signal that takes values in the set $\{0, 1\}$ which corresponds to the *on/off* states and it dictates which functioning mode is active and therefore, control the system. The matrices $F_{\sigma(t)}$ and $g_{\sigma(t)}$ have the following form

$$F_u = \begin{bmatrix} -\frac{R}{L} & -\frac{1-u}{L} \\ \frac{1-u}{C_{out}} & -\frac{1}{R_{out}C_{out}} \end{bmatrix}, \quad g_u = \begin{bmatrix} \frac{V_{in}}{L} \\ 0 \end{bmatrix}, \quad \forall u \in \{0, 1\}.$$

In the next section, a brief overview of switched systems in automatic control is proposed in order to bring the main features of the problem considered along this manuscript.

1.2 Overview of the literature

1.2.1 Switched systems

Generally, a continuous-time switched system can be described mathematically by the following relation [68]

$$\dot{x}(t) = f_{\sigma(t)}(x(t), t), \quad t \in \mathbb{R}. \quad (1.4)$$

The nonlinear dynamical systems (1.4) is composed of a family of regular functions $f_i \in \{f_1, f_2, \dots, f_K\}$ from \mathbb{R}^n to \mathbb{R}^n , where K is the number of subsystems, and a rule that dictates which one of them is being followed [68]. In this representation, $x(t)$ is the system state and $\sigma(t)$ is the piecewise constant signal taking value in the index set $\mathbb{K} := \{1, 2, \dots, K\}$. Such a function has a finite number of discontinuities – called switching times – on every bounded time interval and takes a constant value on every interval between two switching times [68]. Switched systems can also be described in discrete-time by:

$$x(k+1) = f_{\sigma(k)}(x(k), k), \quad k \in \mathbb{N}, \quad (1.5)$$

where the switching function $\sigma : \mathbb{N}^+ \mapsto \mathbb{K}$ is reduced to sequence. Switching events are classified into:

- time-dependent or state-dependent (it can also be both);
- autonomous or controlled.

Some very helpful details about this classification are reported in [68, p. 5-9]. In the case where the switching signal is state-dependent $\sigma(x)$, the continuous state-space can be partitioned into regions called *operating regions*. Into each area, one of the dynamical subsystems is said to be active, *i.e.* the operating regions can be defined by $\mathcal{O}_i = \{x \in \mathbb{R}^n : \sigma(x) = i, i \in \mathbb{K}\}$. The partition is described by *switching surfaces* that separate the operating regions and whenever the system trajectory hits a switching surface, the switching signal takes a new value and the corresponding subsystem becomes active.

While most of the works on autonomous switched systems concern the study of their stability for arbitrary autonomous switching, in the case of controlled switching laws, problems such as stabilization can also be explored. In the case of switched affine systems for instance, the switching signal is of great importance since it is the only control input and an “appropriate” choice of the active mode may allow to stabilize the system, more details will be addressed in Section 1.2.3. In the community studying switched power systems, the interest in controlled switching signals is important and the literature on the subject is quite rich. One of the most popular approaches relies on an average model, allowing to remove the hybrid nature of the systems and to focus on the study of a continuous-time model [4, 29, 92]. The price to pay is that the discrete behavior of the switches is lost, limiting the system performance. Another approach refers to the so-called Pulse Width Modulation (PWM) approach [67, 75], which consists in controlling the ratio on the time spend in some modes over a hyper sampling period. However, last years, there have been remarkable efforts to analyze and control power converters by keeping their hybrid nature [34, 96], often referring to the Hybrid Dynamical Systems (HDS) theory [50]. As a subclass of HDS [50, 68], switched systems combine continuous-time (or discrete-time) dynamics – the dynamics of the state $x(t)$ – associated with discrete events described by the switching events. Hence, the formalism of hybrid dynamical systems is regularly employed to study switched systems, see [3, 19] for some instances. Coming from the literature on HDS, the Zeno-behavior is a phenomenon some continuous-time controls can exhibit [50]. The Zeno-behavior

characterizes the solution that will tend to be eventually discrete. In the present context, this can be understood as an infinite number of switching events within a bounded period of time. Considering state-dependent switching functions, this phenomenon is somehow classic when the partition of the state-space exhibits operating regions with vector fields at the vicinity of the switching surface all oriented toward the switching surface. This type of surface may be resulting to the design of a stabilizing switching law, this type of control is named *sliding control* [35, 90] (see also [71, 72, 98] applied to the case of DC-DC converters control). It is worth mentioning that these design strategies are not fully satisfactory in practice because of the implementation constraints.

Considering switching systems and some of their behaviors just described, it is important to note that the classical solutions or solutions in the sense of Carathéodory may not exist [64]. Indeed, since system (1.4) is a particular class of discontinuous dynamical systems [28], several concepts of solutions can be found [28, 53, 68]. According to [68], a solution to the differential equation (1.4) in the sense of Carathéodory is

$$x(t) = x(t - T_s) + \int_{t-T_s}^t f_{\sigma(\tau)}(x(\tau), \tau) d\tau, \quad \forall t \in \mathbb{R}^+, \quad (1.6)$$

where t represents the time variable and where T_s is a positive scalar. Over this thesis, this concept of solutions will be considered except in this first introductory chapter, where continuous-time controllers from the literature will be presented and solutions in the sense of Fillipov will be better suited to sliding mode controls for instance.

Besides, we would like to stress the guarantee of stability or stabilization of a switched system exposing subsystems with stable behavior is not straightforward. The following example shows some unforeseen situations and introduces at the same time the next section.

Example (Time-dependent switching law): Consider a discrete-time switched linear system given by

$$x(k+1) = A_{\sigma(k)}x(k), \quad x(0) = x_0, \quad k \in \mathbb{N} \quad (1.7)$$

composed of only two subsystems and where the switching signal is time-dependent such that at every computing instant, the signal jumps, *i.e.* $\sigma(k) = 1$ if k is odd and 2 otherwise.

1. System (1.7) composed of two **stable** matrices

$$A_1 = \begin{bmatrix} 0.8 & 0 \\ 1.1 & 0.8 \end{bmatrix}, \quad A_2 = \begin{bmatrix} 0.5 & 0.9 \\ 0.1 & 0.1 \end{bmatrix}. \quad (1.8)$$

2. System (1.7) composed of two **stable** matrices

$$A_1 = \begin{bmatrix} 0.8 & 1.1 \\ 0 & 0.8 \end{bmatrix}, \quad A_2 = \begin{bmatrix} 0.5 & 0.9 \\ 0.1 & 0.1 \end{bmatrix}. \quad (1.9)$$

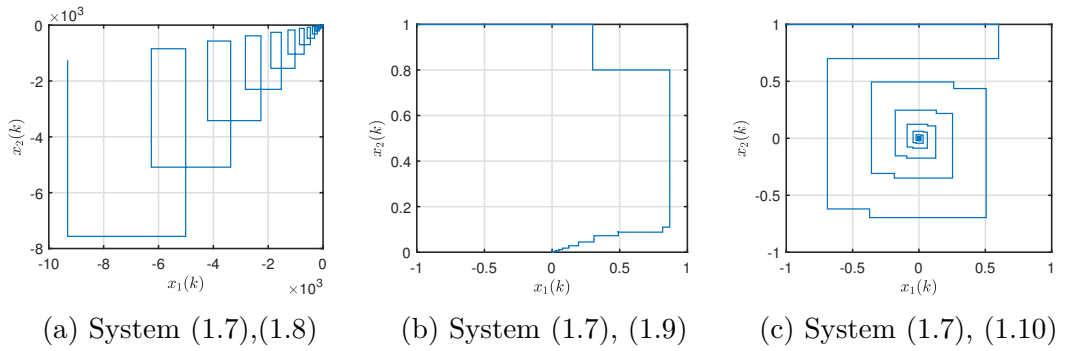

Figure 1.3: Evolution of the state variables represented in the state space.

3. System (1.7) composed of two **unstable** matrices

$$A_1 = \begin{bmatrix} 0 & 0.6 \\ 0.2 & 0.9 \end{bmatrix}, \quad A_2 = \begin{bmatrix} -0.8 & -0.3 \\ -0.8 & -0.2 \end{bmatrix}. \quad (1.10)$$

Through these examples, we are pointing out that even a system composed only of stable subsystems does not imply that the designed switching control still stabilizes the system. See for instance the simulation result on Figure 1.3a, the trajectory of system (1.7),(1.8) starting at $x_0 = [-1, 1]^\top$ diverge. Similarly, there might exist a particular sequence for σ for which the resulting switched systems composed of two unstable modes, is stable. Indeed, Figure 1.3c exposes the case of system (1.7),(1.10) with two unstable matrices which is periodically stable, *i.e.* the trajectories governed by the periodic sequence $\sigma = \{1, 2, 1, 2, \dots\}$ converge to the origin. More details on the periodic stability will be given at proper time.

1.2.2 Switched linear systems

In this section, we focus our attention to switched linear systems which can be described by the following equations

$$\begin{cases} \dot{x}(t) = F_{\sigma(t)}x(t), & t \in \mathbb{R}^+ \\ \sigma(t) = u(x(t)) \in \mathbb{K} \\ x(0) \in \mathbb{R}^n, . \end{cases} \quad (1.11)$$

The switched system is composed of K linear subsystems defined through the constant and known matrices F_i for all $i \in \mathbb{K} = \{1, 2, \dots, K\}$. As described in the previous example, the switching signal has a key role regarding the stability of the system. The objective is generally to design the switching rule $u(x(t))$ such that the origin $x = 0$ is stable. For switched linear systems, the origin generally represents the only equilibrium point and is common to all subsystems. A classic method to obtain this result is to prove the quadratic stabilizability of system (1.11) according to the following definition [42].

Definition 1.1: Quadratic stabilizability

The system (1.11) is said to be quadratically stabilizable to the origin via a state-feedback switching law $u(x)$ if there exist a positive definite function $V(x) = x^\top P x$ and a positive number ϵ such that

$$\frac{d}{dt}V(x(t)) < -\epsilon x(t)^\top x(t) \quad (1.12)$$

holds for all trajectories $x(t) \neq 0$ of system (1.11).

The following theorem is a first solution to quadratic stabilizability (see also [69, 78, 93]) which considers the matrix $F_\lambda = \sum_{i \in \mathbb{K}} \lambda_i F_i$, weighted combination of the set of matrices $\{F_1, \dots, F_K\}$ with the vector $\lambda \in \Lambda$ such that

$$\Lambda = \left\{ \lambda \in \mathbb{R}^K : \lambda_i \geq 0, \forall i \in \mathbb{K}, \sum_{i \in \mathbb{K}} \lambda_i = 1 \right\}, \quad (1.13)$$

and for the sake of understanding the theorem, for some scalar $v_i \in \mathbb{R}$ with $i \in \mathbb{K}$, we note

$$\arg \min_{i \in \mathbb{K}} v_i = \{i \in \mathbb{K} : v_i \leq v_j, \forall j \in \mathbb{K}\}. \quad (1.14)$$

Theorem 1.1: [64, Theorem 5] adapted from [78]

Consider the switched linear system (1.11), if there exist $\lambda \in \Lambda$ and a matrix $P \in \mathbb{S}_+^n$ solution to

$$F_\lambda^\top P + P F_\lambda < 0 \quad (1.15)$$

then, the switching control law

$$u(x(t)) = \arg \min_{i \in \mathbb{K}} x(t)^\top (F_i^\top P + P F_i) x(t) \quad (1.16)$$

ensures that system (1.11) is quadratically stable at the origin.

We may remark that inequality (1.15) is a Bilinear Matrix Inequality (BMI) because of λ and P , two matrix variables multiplying each other. This feasibility problem can be transformed to an LMI problem as it is recalled in [99], the BMI (1.15) is an LMI in P for fixed λ . In particular, it is known that the existence of a solution to (1.15) implies that matrix F_λ is Hurwitz. However, finding vector λ such that matrix F_λ is Hurwitz is known to be an NP-hard problem [14, 93, 97].

Close to this solution, the authors from [47] and [48] proposed a solution to switched linear systems in continuous-time, respectively in discrete-time, based on the existence of a min-type Lyapunov function given by

$$V(x) = \min_{i \in \mathbb{K}} x^\top P_i x \quad (1.17)$$

along with the existence of a matrix Π belonging to the specific class of Metzler matrix denoted by \mathcal{M}_c (respectively \mathcal{M}_d) in continuous-time (resp. in discrete-time) which satisfies the following properties:

- for the continuous-time case,

$$\mathcal{M}_c = \left\{ \Pi = \{\pi_{i,j}\} \in \mathbb{R}^{K \times K} : \pi_{i,j} \geq 0, \forall i \neq j, \sum_{i \in \mathbb{K}} \pi_{i,j} = 0, \forall j \in \mathbb{K} \right\}. \quad (1.18)$$

- for the discrete-time case,

$$\mathcal{M}_d = \left\{ \Pi = \{\pi_{i,j}\} \in \mathbb{R}^{K \times K} : \pi_{i,j} \geq 0, \forall i \neq j, \sum_{i \in \mathbb{K}} \pi_{i,j} = 1, \forall j \in \mathbb{K} \right\}. \quad (1.19)$$

The next Theorem taken from [47] is stated as follows

Theorem 1.2: [47, Theorem 3]

Consider system (1.11), if there exists a set of positive matrices $\{P_1, \dots, P_K\}$ and $\Pi \in \mathcal{M}_c$ satisfying the Lyapunov-Metzler inequalities

$$F_i^\top P_i + P_i F_i + \sum_{i \in \mathbb{K}} \pi_{i,j} P_j < 0, \quad \forall i \in \mathbb{K}, \quad (1.20)$$

then, the state-dependent switching law

$$u(x) = \arg \min_{i \in \mathbb{K}} x^\top P_i x, \quad \forall x \in \mathbb{R}^n \quad (1.21)$$

ensures that the origin of system (1.11) is globally asymptotically stable.

Among other solutions ([43, 58, 63] to cite a few), we can cite [55] where the authors propose a comparison between the Lyapunov-Metzler method we have just introduced and the S-procedure characterization for the existence and computation of min-switching control laws stabilizing the switched linear system (1.11). Besides, similar results can be expressed in discrete-time. The next section is devoted to the literature on switched affine systems, which is the main interest of this thesis.

1.2.3 Switched affine systems

Consider the switched affine system in continuous-time given by

$$\begin{cases} \dot{x}(t) = F_{\sigma(t)} x(t) + g_{\sigma(t)}, & t \in \mathbb{R}^+, \\ \sigma(t) = u(x(t)) \in \mathbb{K}, \end{cases} \quad (1.22)$$

where $x(t)$ represents the state of the state and $\sigma(t)$ switching signal. Due to the affine part, and consequently, nonlinearity, the subsystems do not share the same equilibrium in general. The problems deal usually at ensuring the convergence of the state to a selected reference point that does not necessarily coincide with the equilibria of the modes. Even though this class of nonlinear systems is of particular interest for the stabilization of DC-DC converters [7, 34] for instance, the literature on the subject has been less regarded compared to the one on switched linear systems. Most of the control

design methods considered the existence of a region of attainable equilibrium points. The search of these equilibrium points has aroused great interest in the community, see [34, 40], but it is commonly considered the set of points defined by

$$X_e^c = \{x_e \in \mathbb{R}^n : F_\lambda x_e + g_\lambda = 0, \forall \lambda \in \Lambda\}, \quad (1.23)$$

where the matrices F_λ and g_λ , for a vector $\lambda \in \Lambda$, are defined as convex combination as follows

$$F_\lambda = \sum_{i \in \mathbb{K}} \lambda_i F_i, \quad g_\lambda = \sum_{i \in \mathbb{K}} \lambda_i g_i.$$

Several control design methods have been considered this in the literature as in some instances [16, 61, 59, 93] or [6, 7, 34], where a particular attention to the application to power converters is paid. Here is the result from [34] where the authors designed a switching rule which guides the system trajectory to an equilibrium point determined by the equation (1.23).

Theorem 1.3: [34, Theorem 1]

Consider the switched affine system (1.22), if there exist $\lambda \in \Lambda$ and a positive matrix $P \in \mathbb{S}_+^n$ for a given $x_e \in \mathbb{R}^n$ such that

$$F_\lambda^\top P + P F_\lambda < 0, \quad (1.24)$$

$$F_\lambda x_e + g_\lambda = 0, \quad (1.25)$$

then, the point x_e belongs to the set X_e^c and the switching control law

$$u(x(t)) = \arg \min_{i \in \mathbb{K}} (x(t) - x_e)^\top P (F_i x(t) + g_i) \quad (1.26)$$

ensures that the equilibrium point x_e is globally asymptotically stable.

In the cited paper, it is stressed out that inequality (1.24) imposes that the matrix F_λ is Hurwitz, therefore asymptotically stable, and, that only the point belonging to X_e^c can be reached by the switching strategy. In the same paper, another interesting result is presented, it is stated as follows.

Theorem 1.4: [34, Theorem 2]

Consider the switched affine system (1.22) and let $x_e \in \mathbb{R}^n$ be given. If there exist $\lambda \in \Lambda$ and a positive matrix $P \in \mathbb{S}_+^n$ such that

$$F_i^\top P + P F_i < 0, \quad \forall i \in \mathbb{K} \quad (1.27)$$

$$F_\lambda x_e + g_\lambda = 0, \quad (1.28)$$

then, the point x_e belongs to the set X_e^c and the switching control law

$$u(x(t)) = \arg \min_{i \in \mathbb{K}} (x(t) - x_e)^\top P (F_i x_e + g_i) \quad (1.29)$$

ensures that the equilibrium point x_e is globally asymptotically stable.

While the switching strategy (1.26) is simpler because it is linear, the conditions (1.27) are more stringent than the condition (1.24). The classical condition concerning the existence of a Hurwitz convex combination is avoided in Theorem 1.4 and represents a relaxation to reach in different works (see [65] for instance).

It is worth mentioning that these design strategies are not fully satisfactory in practice because they theoretically produce, around the equilibrium, an infinite number of control updates also called Zeno phenomenon [50], which is not reasonable because of implementation constraints. To solve this issue, there exist different solutions. In [16] or [57], the authors circumvent this issue by introducing some hysteresis when the state is nearby the switching surface. Another possible solution is to introduce a minimum latency between two successive control updates, also known as a dwell time constraint [2, 22, 84, 96]. One can note, however, that the resulting control signals updates are sampled in an aperiodic manner and, in some occasions, due to practical constraints, one needs to impose a periodic implementation. Nevertheless, the previous design solutions together with Theorem 1.4 are based on a common quadratic Lyapunov function, which is known to be conservative and/or restrictive even for switched linear cases [68]. It should be noted that other methods can also lead to a conservative estimate of the attractive set, see [61] for a Lyapunov-Krasovskii approach with respect to aperiodic sampled-data switching controllers.

Another solution provided in the literature consists in considering periodic updates of the control input [54]. Two formulations can result from this consideration:

- A continuous-time switched affine system with sampled-data control input described by

$$\begin{cases} \dot{x}(t) &= F_{\sigma(t)}x(t) + g_{\sigma(t)}, & t \in \mathbb{R}, \\ \sigma(t) &= u(x(t_k)) \in \mathbb{K}, & \forall t \in [t_k, t_{k+1}), k \in \mathbb{N}, \\ x(0) &\in \mathbb{R}^n, \end{cases} \quad (1.30)$$

where $\sigma(t)$ is a sampled-data switching signal which indicates the active mode in each time period $[t_k, t_{k+1})$ and $u(x(t_k))$ the control law to be designed. The sequence $\{t_k\}_{k \in \mathbb{N}}$ is a strictly increasing sequence of time instants for which it is assumed that the sequence tends to infinity as k tends to infinity.

- A discrete-time switched affine system described by

$$\begin{cases} x(k+1) &= A_{\sigma(k)}x(k) + b_{\sigma(k)}, & k \in \mathbb{N}, \\ \sigma(k) &= u(x(k)) \in \mathbb{K}, \\ x(0) &\in \mathbb{R}^n, \end{cases} \quad (1.31)$$

where $\sigma(k)$ is a switching signal and $u(x(k))$ the control law to be designed.

However, due to the nonlinearity and the control means, these two systems cannot be stabilized to a single point (except the equilibria of the modes which is not considered

here). Due to this inevitable situation, the control objectives need to be relaxed to derive acceptable stability results. In this situation, the authors of [6, 33] provide a solution considering a common and quadratic Lyapunov function, which is conservative, leading to a practical stabilization result. This approach was latter relaxed in [37], where the design of practically stabilizing control law was developed thanks to a switched Lyapunov function, reducing then the inherent conservatism of the resulting condition.

The overall objective of this thesis is *to reduce the conservatism made considering this configuration*. The next section presents an example from [33] to discuss about the results and to determine the problems and the possible perspectives.

1.2.4 Example on discrete-time switched affine systems

The objective of this section is to identify some problems occurring while the practical stabilization of switched affine systems is addressed. The result we will talk about is borrowed from [33] published in 2016, *i.e.* few years before the beginning of this PhD. The authors considered in this paper the following system

$$\begin{cases} x(k+1) &= A_{\sigma(k)}x(k) + b_{\sigma(k)}, & k \in \mathbb{N} \\ \sigma(k) &= u(x(k)) \in \mathbb{K}, \\ x(0) &\in \mathbb{R}^n, \end{cases} \quad (1.32)$$

where $x(k)$ represents the state of the system, $\sigma(k)$ the switching signal and $u(x(k))$ the switching rule that will dictate at the computational instants which mode among the finite alphabet the system must follow. Due to the discrete nature of the system and the nonlinearities (the affine part and the control), it is known that the asymptotic stabilization of the system – or any system where a change of the coordinates is performed – cannot be ensured. Therefore, the method undertaken, which appears to be classic for this type of system, is to ensure the convergence of the system trajectory to an invariant set of attraction in the neighborhood of a given equilibrium point $x_e \in X_e^d$,

$$X_e^d = \{x_e \in \mathbb{R}^n : x_e = A_\lambda x_e + b_\lambda, \forall \lambda \in \Lambda\}, \quad (1.33)$$

where the matrices A_λ and b_λ , for a vector $\lambda \in \Lambda$, are defined as convex combination as follows

$$A_\lambda = \sum_{i \in \mathbb{K}} \lambda_i A_i, \quad b_\lambda = \sum_{i \in \mathbb{K}} \lambda_i b_i.$$

Hence, in this purpose, we consider the following system defined with the auxiliary variable $\xi(k) = x(k) - x_e$

$$\xi(k+1) = A_{\sigma(k)}\xi(k) + \ell_{\sigma(k)} \quad (1.34)$$

with $\ell_i = (A_i - I_n)x_e + b_i, \forall i \in \mathbb{K}$.

Definition 1.2: Invariant set of attraction [33, Definition 1]

A bounded set $\mathcal{V} \subset \mathbb{R}^n$ is an invariant set of attraction of system (1.34) governed by the state-dependent switching function $\sigma(\xi)$ if there exists a positive definite Lyapunov function $V : \mathbb{R}^n \rightarrow \mathbb{R}$ such that the following conditions are simultaneously fulfilled:

- a) $0 \in \mathcal{V}$,
- b) If $\xi(k) \notin \mathcal{V}$, then $\Delta V := V(\xi(k+1)) - V(\xi(k)) < 0$,
- c) If $\xi(k) \in \mathcal{V}$, then $A_{\sigma(k)}\xi(k) + \ell_{\sigma(k)} \in \mathcal{V}$.

Remark 1. In this definition, the second item “b)” corresponds to the attractive property of the set \mathcal{V} while the item “c)” guarantees its invariance. Plus, since the set is bounded and the origin is inside, the definition falls into the context of practical stabilization to $\xi = 0$.

Then, it is shown in [33] that the shifted Lyapunov function

$$V(\xi) = (\xi + P^{-1}h)^\top P (\xi + P^{-1}h), \quad (1.35)$$

with h a vector to be determined, is a good candidate Lyapunov function and its level set defines the invariant set \mathcal{V} as

$$\mathcal{V} = \{\xi \in \mathbb{R}^n : V(\xi) \leq 1\}. \quad (1.36)$$

Theorem 1.5: [33, Theorem 3]

Consider the switched affine system (1.34) and determine ℓ_i , for all $i \in \mathbb{K}$, with the given desired equilibrium point $x_e \in X_e^d$ associated to $\lambda \in \Lambda$. From the optimal solution P^* of the problem

$$\inf_{P>0, W>0, \beta>0} -\log \det P \quad (1.37)$$

subject to

$$\sum_{i \in \mathbb{K}} \lambda_i A_i^\top P A_i - P < -W, \quad (1.38)$$

$$\sum_{i \in \mathbb{K}} \lambda_i \begin{bmatrix} 1 - \beta \ell_i^\top P \ell_i & -\ell_i^\top P A_i (I_n - A_\lambda)^{-1} & 0 \\ * & P & P \\ * & * & \beta W \end{bmatrix} > 0, \quad (1.39)$$

determine $h = \sum_{i \in \mathbb{K}} \lambda_i \ell_i^\top P^* A_i (I_n - A_\lambda)^{-1}$ and the quadratic Lyapunov function (1.35). The state feedback switching function

$$u(\xi) = \arg \min_{i \in \mathbb{K}} V(A_i \xi + \ell_i), \quad (1.40)$$

ensures that the set (1.36) is the invariant set of attraction with minimum volume.

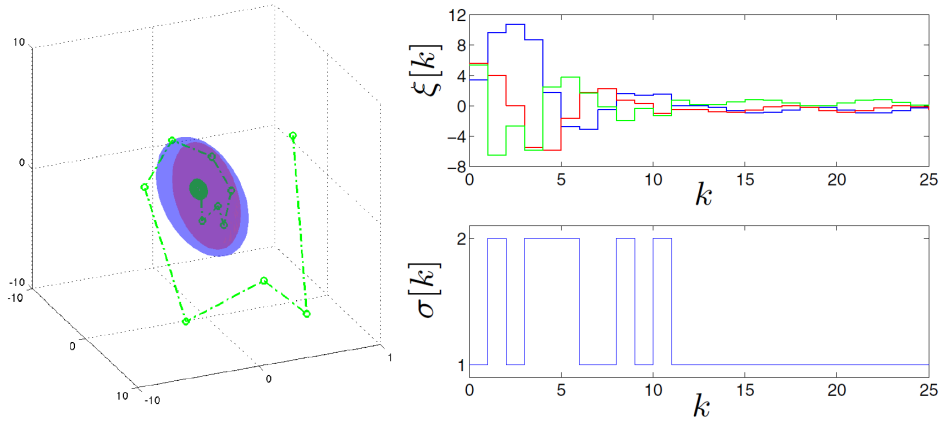

Figure 1.4: Figure extracted from [33]

The previous result is illustrated through the following example where matrices A_i and B_i are defined as follows

$$A_i = e^{F_i T}, \quad b_i = \int_0^T e^{F_i \tau} d\tau g_i, \quad \forall i \in \{1, 2\}, \quad (1.41)$$

where $T = 1$ refers to the sampling period. Matrices F_i and g_i for $i = 1, 2$ are given by

$$F_1 = \begin{bmatrix} 0 & 1 & 0 \\ 0 & 0 & 1 \\ -1 & -1 & -1 \end{bmatrix}, \quad F_2 = \begin{bmatrix} 0 & 1 & 0 \\ 0 & 0 & 1 \\ 0 & -1 & -1 \end{bmatrix}, \quad g_1 = \begin{bmatrix} 1 \\ 0 \\ 0 \end{bmatrix}, \quad g_2 = \begin{bmatrix} 0 \\ 1 \\ 0 \end{bmatrix}.$$

Figure 1.4 was extracted from [33] to be conformed with the simulations of the authors. It depicts on the left the trajectory of system (1.34) represented by the green dots starting from $\xi(0) = [3.45, 5.6, 5.4]^T$ represented in the phase space, and on the right, the corresponding time simulation of the auxiliary state $\xi[k]$ and the switching signal $\sigma[k]$ (on Figure 1.4 extracted from [33], the authors have used the notation $\xi[k] = \xi(k)$, $\sigma[k] = \sigma(k)$).

From this simulation result, we can identify that the convergence of the trajectory to the desired equilibrium is ensured with a practical stability guarantee. The evolution of the state with respect to the time lets us think that there is still some oscillations in steady-state but these are unavoidable because of the sampled-data control implementation; the size of the oscillations depends on it. Besides, it is expected that the volume of the invariant set of attraction reduces with the sampling period decreasing. Looking at Figure 1.4, we can see that the invariant set of attraction represented by the ellipsoid is rather large compared to the region where the state seems to live in steady-state (green dots). This implies that the optimization problem could be improved and/or that the conservatism of the method could be reduced. In light of the discussion above, several ideas come in mind in order to refine this method:

- Consider an optimization problem where the origin does not necessarily belongs to the invariant set of attraction. In the counter part, the practical stabilization can still be ensured with some offset regarding the desired equilibrium. Besides, the offset can be associated with a cost function to provide an additional optimization criterion.
- Since the oscillations are unavoidable, maybe characterizing them could help to define a more accurate set.

On another note, the present switching control law depends on the system matrices and, consequently, is not suited to some developments where the matrices could be affected by uncertainties.

These details have already been the subject of works (see [6] for instance) but they are highlighted here because they represent common features for the developed methods for switched affine systems with a sampled-data control which represent the basis and the motivation of the thesis.

1.3 Problem statement and contributions

At different points in this introduction, some problems regarding the study and the control of switched affine systems have been pointed out. This section aims to properly formulate stabilization problems of this kind of systems, as well as, to summarize the main contributions.

In this thesis, we consider systems of the form (1.30) or (1.31), in other words, switched affine systems with a periodically sampled switching rule. The switching control law is calculated at certain equidistant time instants, which are characterized by the sampling period. Due to the affine part, and consequently nonlinear nature, this implies that except for the case of specific equilibrium to each subsystem, the asymptotic stabilization of system (1.30) or (1.31) cannot be guaranteed. The first problem is then to

- *relax the control objectives to derive acceptable stability results.*

For instance, a practical stability result is derived in Section 1.2.4 where the method from [33] is discussed. It is shown therein, that the solutions to the switched affine system converge to an invariant region characterized by a level set of a Lyapunov function centered at a desired operating point or at a slightly shifted point nearby this position. However, as we can see on Figure 1.4, the steady state solutions seem to live in a smaller region than the ellipsoidal attractor. Then, one of the subsequent problems to study would be to

- *reduce the conservatism of this method while characterizing the set where the solutions to the closed-loop system converge to.*

In order to achieve this, the first idea based on the simulation results is to estimate the invariant set of attraction by multiple subsets; possibly disjoint thanks to the discrete nature of the dynamics (1.31). But this idea is necessarily followed by the next question.

- *How can we determine the number of subsets? How can we link them to the modes of the system?*

These may still be pending questions but they are not entirely unanswered if we consider the following problem.

- *Can each subset of the attractor be reduced to a single point? In this perspective, is there a single mode to steer the state from a subset to another?*

Besides equilibrium points, dynamical systems may have as asymptotic behaviors such as self-sustained oscillations or limit cycles [95, Section 7]. The studies on limit cycles have been initiated by Henri Poincaré and are generically related to the ω -limit sets (set of accumulation points of the trajectories) and Poincaré-Bendixson theorem. For hybrid or switched systems, the investigations were mainly done in the continuous-time domain, motivated by switched circuits [9, 51, 62, 82, 83]. The Poincaré-Bendixson theorem has been extended for hybrid systems [91] and the ω -limit sets of hybrid systems have been also investigated [25]. The main difficulty is to determine the switching times related to a limit cycle [45, 49]. This issue is avoided, however, because the switching times are fixed in the present context. So the persistent question is:

- *Can we characterize one or several limit cycles for a given switched affine system?*

Recently, the literature on switched affine system has seen the emergence of studies about their stabilization to limit cycle [36, 38]. Even though their results are very interesting, these cannot be extended to the case of uncertain systems, yet still a relevant problem.

- *Considering an uncertain system, is it possible to have some guarantees of convergence of the trajectories to the vicinity of a limit cycle?*

We have been able to answer some of these questions. Here is the list of the contributions reported along this thesis.

1. We have introduced a new class of control Lyapunov function. While most of the existent works define multiple Lyapunov functions with different Lyapunov matrices associated with the functioning modes, we have proposed here a multiple shifted Lyapunov function. This has resulted to a drastic reduction of the attractor's size.
2. We have rigorously defined the limit cycle in the framework of discrete-time switched affine systems and studied the conditions to their existence.
3. In addition, we have designed a pure state feedback switching control law guaranteeing the exponential stabilization of the system to a limit cycle.
4. We have then shown the extendability of our method to the case of switched affine systems subject to model uncertainties.
5. Finally, (almost) all the results are obtained via the solutions to LMI problems, even in the case of sampled-data switched affine systems expressed in an Hybrid Dynamical System (HDS) framework.

1.4 Organization of the manuscript

This thesis is organized as follows.

- Chapter 2 presents the first contribution on the reduction of the conservatism made while defining the invariant set of attraction for a switched affine system in discrete-time. In particular, it introduces a new class of control Lyapunov function which is a milestone for the following results.
- Chapter 3 paves the way for the forthcoming chapters. It starts with a brief review on the literature on limit cycles and continues with definitions and notions related to limit cycles for switched systems. Particular attention is given to limit cycles of switched affine systems in discrete-time.
- In Chapter 4, the design of the switching control law stabilizing the system to *a priori* determined limit cycles. The novel result is compared to the recent literature on the subject and illustrated through some examples.
- This result is extended to the case of uncertain switched affine systems in Chapter 5. The notion of hybrid limit cycles is resumed to suit the context.
- Background on the formalism of hybrid dynamical systems is presented in the Chapter 6. The notion of hybrid limit cycles is again adapted to the context and a hybrid switching control law is proposed to stabilize sampled-data switched affine systems to a limit cycle.
- Lastly, Chapter 7 concludes the manuscript and provides details on the work underway, putting into perspective the results obtained during this PhD.

1.5 List of publications

International journals

1. Mathias Serieye, Carolina Albea, Alexandre Seuret, and Marc Jungers. Robust stabilization to limit cycles of switching discrete-time affine systems using control Lyapunov functions. Under review, 2021

International conferences

1. Mathias Serieye, Carolina Albea, and Alexandre Seuret. Free-matrices min-projection control for high frequency DC-DC converters. In *IEEE 58th Conference on Decision and Control (CDC)*, pages 2491–2496, 2019
2. Mathias Serieye, Carolina Albea, Alexandre Seuret, and Marc Jungers. Stabilization of switched affine systems via multiple shifted Lyapunov functions. In *21st IFAC World Congress*, volume 53, pages 6133–6138, 2020

3. Mathias Serieye, Carolina Albea, Alexandre Seuret, and Marc Jungers. Synchronization on a limit cycle of multi-agent systems governed by discrete-time switched affine dynamics. *IFAC-PapersOnLine*, 54(5):295–300, 2021. 7th IFAC Conference on Analysis and Design of Hybrid Systems ADHS 2021

2

Practical stabilization via multiple shifted control Lyapunov functions

Following the thread given in the first chapter, this chapter focuses on a discretized version of switched affine systems. The novelty brought in this chapter is to consider an attractor composed by the union of several – potentially disjoint – subsets. The resulting method is based on a new class of control Lyapunov function and provides a more accurate invariant set for the closed-loop system. This class of Lyapunov functions is introduced in the first section and will be the basis for all results presented in the forthcoming chapters. Section 2.2 presents the different contributive solutions, which will be then illustrated on two numerical examples in Section 2.4.

2.1 Problem formulation

Consider the switched affine system governed by the following discrete-time dynamics

$$\begin{cases} x(k+1) = A_{\sigma(k)}x(k) + b_{\sigma(k)}, & k \in \mathbb{N}, \\ \sigma(k) = u(x(k)), \end{cases} \quad (2.1)$$

where $x(k) \in \mathbb{R}^n$ is the state vector, $\sigma(k) \in \mathbb{K} = \{1, 2, \dots, K\}$ characterizes the active mode and $k \in \mathbb{N}$ stands for the time variable. In this chapter, the matrices (A_i, b_i) of mode $i \in \mathbb{K}$ are supposed to be known, constant and of suitable dimension. As mentioned before, due to the discrete nature of the model and its nonlinearities, the asymptotic stabilization to a given operating point cannot be achieved in general. Since such objective cannot be realized, one has to relax it and derives an acceptable stability result. The method consists then to define a set where the state trajectories must be steered toward and kept in afterwards. Section 1.2 in Chapter 1 presents some contributions where the authors derive practical stabilization of switched affine systems. Compared to the existing solutions, we deal with getting a better estimation of the attracting region where all trajectories of system (2.1) converge to, regardless the initial condition. In order to derive more accurate results, one has to use more advanced tools and Lyapunov functions arising in switched affine systems. A first attempt was considered in [48] for switched linear systems where multiple Lyapunov functions were investigated. In addition, it is note-worthy that the discrete-time nature of the dynamics (2.1) allows to consider disconnected sets as pointed out in [24]. Hence, with the idea to define the attracting and invariant set based on – possibly disconnected – Lyapunov

functions' level sets, we propose a different Lyapunov function inspired from [37] defined as follows

$$V(x) = \min_{i \in \mathbb{K}} \left(x - \zeta_i \right)^\top P \left(x - \zeta_i \right), \quad \forall x \in \mathbb{R}^n. \quad (2.2)$$

This min-function is composed of a unique symmetric positive definite matrix $P \in \mathbb{R}^{n \times n}$ but has several possible shifted centers represented by the vectors $\zeta_i \in \mathbb{R}^n$, $i \in \mathbb{K}$. The resulting set, called *attractor*, is given by

$$\mathcal{A} := \{ x \in \mathbb{R}^n : V(x) \leq 1 \}. \quad (2.3)$$

Due to the definition of the candidate Lyapunov function (2.2), the attractor can be seen as the union of the ellipsoids

$$\mathcal{E}(P, \zeta_i) = \left\{ x \in \mathbb{R}^n, i \in \mathbb{K} : (x - \zeta_i)^\top P (x - \zeta_i) \leq 1 \right\}. \quad (2.4)$$

Depending on the selection of matrix P and on the shifted centers ζ_i , the attractor may not be a convex nor a connected set. Indeed, we will see in the example section, that the level set of the Lyapunov function may characterize several disjoint regions. To sum up, the purpose of this chapter, the problem can be formulated as follows.

For the discrete switched affine system (2.1), the objectives are

- *to design the state-dependent switching control law $u(x(k))$, which ensures the global asymptotic stabilization of the state trajectories to the attractor \mathcal{A} .*
- *to determine an LMI problem to minimize the size of the ellipsoids defining the attractor \mathcal{A} in order to get an accurate characterization.*

2.2 Switching rule design

This section presents the main results of this chapter. The problem is treated using a *min-switching* strategy that differs from the classic ones proposed in [55] or [37] for instance. The former applies it to switched linear systems, the latter to switched affine systems. Two optimization problems are proposed in the present section: on one hand, a non-convex optimization problem in the general case; on the other hand, a convex optimization problem for switched affine systems with only two modes.

2.2.1 Preliminaries

The following result is a preliminary, it is taken from [48] and provides an equivalence between a minimum of a set of values and their convex linear combination. Lemma 2.1 adapted from [23] formalizes this statement which will be useful for the proof of Theorem 2.1 on the facing page. Before, let us define the set Λ as subset of $(0, 1)^K$ given by

$$\Lambda := \left\{ \lambda \in \mathbb{R}^K : \lambda_i \in (0, 1), i \in \mathbb{K}, \sum_{i \in \mathbb{K}} \lambda_i = 1 \right\}. \quad (2.5)$$

Lemma 2.1: [23, Lemma 11]

For some scalars v_i , $i \in \mathbb{K}$, the following equality holds

$$\min_{i \in \mathbb{K}} v_i = \inf_{\lambda \in \Lambda} \sum_{i \in \mathbb{K}} \lambda_i v_i. \quad (2.6)$$

In particular, this ensures that for any element λ in Λ , the following inequality holds

$$\min_{i \in \mathbb{K}} v_i \leq \sum_{i \in \mathbb{K}} \lambda_i v_i. \quad (2.7)$$

When related to the Lyapunov function, this result allows us to upper bound $V(x)$ by a combination of the quadratic terms $(x - \zeta_i)^\top P (x - \zeta_i)$, $i \in \mathbb{K}$.

2.2.2 Main result

The condition for which the attractor is globally asymptotically stable for system (2.1) thanks to the state-dependent control law is stated in the next theorem.

Theorem 2.1

Consider parameters $\mu \in (0, 1)$, $\lambda^i \in \Lambda$, with $i \in \mathbb{K}$, a positive definite matrix $W \in \mathbb{R}^{n \times n} \succ 0$, and vectors $\zeta_i \in \mathbb{R}^n$, $i \in \mathbb{K}$, that are the solutions to the following non-convex optimization problem

$$\min_{\mu, W, \zeta_i, \lambda^i} \text{Tr}(W), \quad \Psi_i = \begin{bmatrix} -(1 - \mu)W & 0 & \mathbb{A}_i(\lambda^i) \\ * & -\mu & \mathbb{B}_i(\lambda^i) \\ * & * & -\mathbb{D}_i(\lambda^i) \end{bmatrix} \prec 0, \quad \forall i \in \mathbb{K}. \quad (2.8)$$

Then, the switching control law $u(x(k))$ given by

$$u(x(k)) \in G(x(k)) = \arg \min_{i \in \mathbb{K}} \left(x(k) - \zeta_i \right)^\top W^{-1} \left(x(k) - \zeta_i \right), \quad \forall x(k) \in \mathbb{R}^n, \quad (2.9)$$

ensures that the set \mathcal{A} is globally asymptotically stable for system (2.1).

For all $i \in \mathbb{K}$, the matrices \mathbb{A}_i , \mathbb{B}_i and \mathbb{D}_i are defined as follows

$$\begin{aligned} \mathbb{A}_i(\lambda^i) &= \left[\lambda_1^i W A_1^\top \quad \dots \quad \lambda_K^i W A_K^\top \right], \\ \mathbb{B}_i(\lambda^i) &= \left[\lambda_1^i \left(A_1 \zeta_i + b_i - \zeta_1 \right)^\top \quad \dots \quad \lambda_K^i \left(A_K \zeta_i + b_i - \zeta_K \right)^\top \right], \\ \mathbb{D}_i(\lambda^i) &= \text{diag}(\lambda_1^i W, \dots, \lambda_K^i W). \end{aligned}$$

Proof. The proof aims at demonstrating that \mathcal{A} defined in (2.3) is globally asymptotically stable provided that the conditions of Theorem 2.1 are verified. To do so, the two following items have to be considered

- V given in (2.2) is a Lyapunov function for the system (2.1), (2.9), with $P = W^{-1}$.
- \mathcal{A} is invariant for the system (2.1),(2.9).

In order to prove the first item, let us compute the increment of the Lyapunov function. This leads to

$$\Delta V(x(k)) = \min_{j \in \mathbb{K}} \left(x(k+1) - \zeta_j \right)^\top P \left(x(k+1) - \zeta_j \right) - \min_{i \in \mathbb{K}} \left(x(k) - \zeta_i \right)^\top P \left(x(k) - \zeta_i \right).$$

According to the switching control law (2.9), the active mode $\sigma(k)$ corresponds to the set of modes that minimize the Lyapunov function at time k (see definition (1.14) in Section 1.2.2 on page 6). It allows us to write

$$\Delta V(x(k)) = \min_{j \in \mathbb{K}} \left(x(k+1) - \zeta_j \right)^\top P \left(x(k+1) - \zeta_j \right) - \left(x(k) - \zeta_{\sigma(k)} \right)^\top P \left(x(k) - \zeta_{\sigma(k)} \right).$$

Thanks to inequality (2.7), the following inequality holds for any element $\lambda^{\sigma(k)}$ in Λ .

$$\Delta V(x(k)) \leq \sum_{j \in \mathbb{K}} \lambda_j^{\sigma(k)} \left(x(k+1) - \zeta_j \right)^\top P \left(x(k+1) - \zeta_j \right) - \left(x(k) - \zeta_{\sigma(k)} \right)^\top P \left(x(k) - \zeta_{\sigma(k)} \right),$$

where $\lambda_j^{\sigma(k)}$ is the j^{th} component of $\lambda^{\sigma(k)}$.

Let us now focus on the first positive terms of the previous expression. Replacing $x(k+1)$ by its expression from (2.1), we note that $x(k+1) - \zeta_j = A_{\sigma(k)}x(k) + b_{\sigma(k)} - \zeta_j$. Our objective is to rewrite the previous expression using $x(k) - \zeta_{\sigma(k)}$, in order to take the full benefits of the negative terms of the Lyapunov increment. Simple manipulations yield

$$x(k+1) - \zeta_j = A_{\sigma(k)} \left(x(k) - \zeta_{\sigma(k)} \right) + A_{\sigma(k)} \zeta_{\sigma(k)} + b_{\sigma(k)} - \zeta_j.$$

Let us now introduce a new vector, $\chi(k)$, given by

$$\chi(k)^\top = \left[\left(x(k) - \zeta_{\sigma(k)} \right)^\top P \quad 1 \right]^\top, \quad (2.10)$$

and matrix $W = P^{-1} \succ 0$ and then, we obtain the following expression

$$x(k+1) - \zeta_j = \begin{bmatrix} A_{\sigma(k)}W & A_{\sigma(k)}\zeta_{\sigma(k)} + b_{\sigma(k)} - \zeta_j \end{bmatrix} \chi(k).$$

Hence, gathering all the terms in the sum and using the notations introduced in Theorem 2.1, we have

$$\Delta V(x(k)) \leq \chi(k)^\top \Phi \left(\sigma(k), \lambda^{\sigma(k)} \right) \chi(k), \quad (2.11)$$

where matrix $\Phi(\sigma(k), \lambda^{\sigma(k)})$ is given by

$$\Phi(\sigma(k), \lambda^{\sigma(k)}) = \begin{bmatrix} \mathbb{A}_{\sigma(k)}(\lambda^{\sigma(k)}) \\ \mathbb{B}_{\sigma(k)}(\lambda^{\sigma(k)}) \end{bmatrix} \mathbb{D}_{\sigma(k)}^{-1}(\lambda^{\sigma(k)}) \begin{bmatrix} \mathbb{A}_{\sigma(k)}(\lambda^{\sigma(k)}) \\ \mathbb{B}_{\sigma(k)}(\lambda^{\sigma(k)}) \end{bmatrix}^\top - \begin{bmatrix} W & 0 \\ 0 & 0 \end{bmatrix}, \quad (2.12)$$

where the matrices \mathbb{A}_i , \mathbb{B}_i and \mathbb{D}_i are defined just below the statement of Theorem 2.1. It is worth noting that the components of λ^i are assumed to be strictly positive. Noting that the increment of the Lyapunov function has been properly expressed, the next step consists in ensuring its negative definiteness only outside the attractor defined in (2.3). To do so, we use notations $\chi(k)$ and W introduced above and we note that any vector $x(k)$ outside of the attractor verifies

$$\begin{bmatrix} x(k) - \zeta_{\sigma(k)} \\ 1 \end{bmatrix}^\top \begin{bmatrix} P & 0 \\ 0 & -1 \end{bmatrix} \begin{bmatrix} x(k) - \zeta_{\sigma(k)} \\ 1 \end{bmatrix} = \chi(k)^\top \begin{bmatrix} W & 0 \\ 0 & -1 \end{bmatrix} \chi(k) > 0. \quad (2.13)$$

The previous problem can be rewritten as

$$\chi(k)^\top \Phi(\sigma(k), \lambda^{\sigma(k)}) \chi(k) < 0,$$

for all vector $\chi(k)$ that verifies (2.13). Using an S-procedure, this problem is equivalent to the existence of a positive scalar μ , such that,

$$\Phi(\sigma(k), \lambda^{\sigma(k)}) + \mu \begin{bmatrix} W & 0 \\ 0 & -1 \end{bmatrix} \prec 0. \quad (2.14)$$

Then, the proof of the first item is concluded by application of Schur complement to the first term of $\Phi(\sigma(k), \lambda^{\sigma(k)})$, leading to inequality (2.8).

To conclude the proof, it remains to prove that \mathcal{A} is invariant, corresponding to the second item. Assume that $x(k)$ is in the attractor at a given instant k , i.e. $V(x(k)) < 1$. Together with (2.8), we know that the following inequality

$$\begin{aligned} V(x(k+1)) &= V(x(k)) + \Delta V(x(k)) \\ &= V(x(k)) - \mu(V(x(k)) - 1) \\ &\quad + \chi(k)^\top \left(\Phi(\sigma(k), \lambda^{\sigma(k)}) + \mu \begin{bmatrix} W & 0 \\ 0 & -1 \end{bmatrix} \right) \chi(k) \\ &= (1 - \mu)V(x(k)) + \mu + \underbrace{\chi(k)^\top \left(\Phi(\sigma(k), \lambda^{\sigma(k)}) + \mu \begin{bmatrix} W & 0 \\ 0 & -1 \end{bmatrix} \right) \chi(k)}_{< 0} \\ &\leq (1 - \mu)V(x(k)) + \mu \end{aligned}$$

holds where the last inequality has been obtained from the negative definiteness of inequalities (2.8) and (2.14). The assumptions that $x(k)$ is in the attractor and that $\mu \in (0, 1)$ yield

$$V(x(k+1)) \leq (1 - \mu) + \mu = 1,$$

which guarantees that $x(k+1)$ also belongs to \mathcal{A} . \square

2.3 Discussions regarding the main result

This section aims at giving some details about the main result of this chapter.

2.3.1 The control Lyapunov function (2.2)

When designing it, a natural choice was to consider the same number of shifted centers as the number of modes. An assumption that can be seen as restrictive but relax it implies to define a function to make the relation between the different quadratic terms and the modes of the system. For example, we could consider a function ν that associates the elements of some finite set $\mathbb{D}_\nu := \{1, \dots, N_\nu\}$, $N_\nu \in \mathbb{N}$, to the index set of the system \mathbb{K} . Then, we could define a switching control law depending on \mathbb{D}_ν such that

$$u(x(k)) = \left\{ \nu(\theta) : \theta \in \arg \min_{i \in \mathbb{D}_\nu} (x - \zeta_i)^\top P (x - \zeta_i) \right\} \subseteq \mathbb{K}. \quad (2.15)$$

However, this development implies an increase of the number of parameters $\lambda^i \in \Lambda$ which is already a drawback. More details are given in Section 2.3.5.

2.3.2 The importance of the parameters λ belonging to $(0, 1)^K$

Another comment can be made regarding matrices $\Phi(i, \lambda^i)$ and $\mathbb{D}_i(\lambda^i)$, $i \in \mathbb{K}$. Indeed, matrices $\Phi(i, \lambda^i)$ defined in the proof of Theorem 2.1 have a key role and is properly formulated if and only if matrices $\mathbb{D}_i(\lambda^i)$ are non singular for all $i \in \mathbb{K}$. Matrices $\Phi(i, \lambda^i)$ is important since its negative definiteness proves that the Lyapunov function V is decreasing all along the trajectories of $x(k)$ outside the attractor. However, it can be noticed that $\Phi(i, \lambda^i)$ does not exist if at least one of the components of λ_i equals zero. This explains why the choice made was to consider the particular simplex Λ , *i.e.* with its elements belonging to the open interval $(0, 1)$ rather than the closed one. In the case where we consider parameters $\lambda^i \in \bar{\Lambda}$, with $\bar{\Lambda}$ given by

$$\bar{\Lambda} := \left\{ \lambda \in \mathbb{R}^K : \lambda_i \in [0, 1], \sum_{i \in \mathbb{K}} \lambda_i = 1 \right\}, \quad (2.16)$$

the negative definiteness of the matrix in (2.8) should be replaced by a negative semi-definiteness condition. Indeed, in the case where some λ^i 's equal 0, the matrix has columns and rows of zeros where those λ^i 's are.

2.3.3 Minimization of the attractor's size

There exist different methods to optimize the size of ellipsoids centered in ζ_i , $i \in \mathbb{K}$, defined by (2.4). In general, since the volume of such ellipsoids is proportional to $(\det P)^{-1/2}$, the minimization often considers $\log \det P^{-1}$ as criterion (see [18, Section 2.2.4]). However, an interesting comment is made in [79, Section 3.5] concerning the

optimization of the size/volume of an ellipsoid. According to the authors of [79], it is more suitable to use the criterion $\text{Tr } P$ since

$$\text{Tr } P = \sum_{i=1}^n \text{eig}_i(P) \geq \max_{i=1, \dots, n} \text{eig}_i(P).$$

Note that the minimization of $\text{Tr } P$ ensures, at least, the minimization of its maximum eigenvalue, and hence, the minimization of $\sqrt{\text{eig}_{\max}(P)}$.

2.3.4 About centers ζ_i and translated models

Usually for the class of switched affine systems, it is first required to define a translated system where the origin becomes located at a desired operating point. The reader may refer to [33], for instance. It is then important to stress whether the attractor is affected by this translation. To better understand this issue, let us define the translated variable $\xi = x - \delta$, where δ is any vector in \mathbb{R}^n . The shifted dynamics of system (2.1) are

$$\begin{cases} \xi(k+1) = A_{\sigma(k)}\xi(k) + \tilde{b}_{\sigma(k)}, & k \in \mathbb{N}, \\ \sigma(k) \in \mathbb{K}, \\ \xi_0 \in \mathbb{R}^n, \end{cases} \quad (2.17)$$

where $\tilde{b}_{\sigma(k)} = (A_{\sigma(k)} - I)\delta + b_{\sigma(k)}$. Then, the following proposition holds.

Proposition 2.1

Assume that $(\mu, W, \{\zeta_i, \lambda^i\}_{i \in \mathbb{K}})$ is a solution to the optimization problem of Theorem 2.1 for the original system $(A_i, b_i)_{i \in \mathbb{K}}$. Then, $(\mu, W, \{\zeta_i - \delta, \lambda^i\}_{i \in \mathbb{K}})$ is a solution to the same optimization problem but for the translated system $(A_i, \tilde{b}_i)_{i \in \mathbb{K}}$.

Proof. The proof simply consists in noting that the only difference between the original and the translated system appears in the definition of the affine terms that are gathered in matrices $\mathbb{B}_i(\lambda^i)$. Since, the same coefficients λ_i 's are considered, one has to focus on $A_i\zeta_i + b_i - \zeta_j$, for every i and j in \mathbb{K} . The proof straightforwardly follows from the fact that, for every i and j in \mathbb{K} , we have

$$A_i\zeta_i + b_i - \zeta_j = A_i(\zeta_i - \delta) + \underbrace{A_i\delta + b_i - \delta}_{\tilde{b}_i} - (\zeta_j - \delta).$$

This manipulation allows us to conclude the proof. \square

Proposition 2.1 stresses that the shifted centers ζ_i 's are intrinsically the same, whatever the translation of coordinates. This is an important remark, since it proves that there is no need to apply any affine change of coordinates before applying Theorem 2.1.

2.3.5 Comments on the resolution of the non convex problem

As indicated in its statement, the optimization problem of Theorem 2.1 is non convex due to the multiplication of decision variables, such as for instance $\lambda_j^i W$ in the definition of matrices \mathbb{D}_i (see below Theorem 2.1). However, this problem can be made convex (see [18] for instance) by fixing $\mu \in (0, 1)$ and $\lambda^i \in (0, 1)^K$, with $i \in \mathbb{K}$. The number of these parameters is thus equal to $1 + K(K - 1)$. Of course, this is not realistic for large values of K , but for $K = 2$, the number of parameters to fix is only 3, which is reasonable. This is formulated in the following proposition.

Proposition 2.2

For given parameters $\mu, \gamma_1, \gamma_2 \in (0, 1)$, the solution including the symmetric positive definite matrix $W \in \mathbb{R}^{n \times n} \succ 0$ and the vectors $\zeta_i \in \mathbb{R}^n$ to the convex optimization problem

$$\min_{W, \zeta_i} \text{Tr}(W) \quad (2.18)$$

subject to the constraints

$$W \succ 0, \quad (2.19)$$

$$\begin{bmatrix} -(1 - \mu)W & 0 & \bar{\mathbb{A}}_i(\gamma_i) \\ * & -\mu & \bar{\mathbb{B}}_i(\gamma_i) \\ * & * & -\bar{\mathbb{D}}_i(\gamma_i) \end{bmatrix} \prec 0, \quad \forall i = 1, 2, \quad (2.20)$$

where

$$\begin{aligned} \bar{\mathbb{A}}_i(\gamma_i) &= \begin{bmatrix} \gamma_i W A_i^\top & (1 - \gamma_i) W A_i^\top \end{bmatrix}, \\ \bar{\mathbb{B}}_i(\gamma_i) &= \begin{bmatrix} \gamma_i (A_i \zeta_i + b_i - \zeta_1)^\top & (1 - \gamma_i) (A_i \zeta_i + b_i - \zeta_2)^\top \end{bmatrix}, \\ \bar{\mathbb{D}}_i(\gamma_i) &= \text{diag}(\gamma_i W, (1 - \gamma_i) W). \end{aligned}$$

Then, the switching control law $\sigma(k)$ given by

$$u(x(k)) \in G_2(x(k)) = \underset{i=1,2}{\text{argmin}} (x(k) - \zeta_i)^\top W^{-1} (x(k) - \zeta_i), \quad \forall x(k) \in \mathbb{R}^n, \quad (2.21)$$

ensures that \mathcal{A} is globally asymptotic stable for system (2.1).

Proof. The proof is obtained by the introduction of parameters γ_i , such that, for $K = 2$, we have $\lambda_1^i = \gamma_i$ and $\lambda_2^i = 1 - \gamma_i$. \square

2.4 Examples

Through this section, we aim at illustrating our contributions through different examples that have been already treated in the literature.

2.4.1 Example 1

Consider the discrete-time switched affine system (2.1) with two modes ($K = 2$) and the following matrices

$$A_i = e^{F_i T_s}, \quad b_i = \int_0^{T_s} e^{F_i \tau} d\tau g_i, \quad \forall i \in \{1, 2\}, \quad (2.22)$$

where T_s , referring to a sampling period is taken equal to 1 and where matrices F_i and g_i for $i \in \mathbb{K}$ are given by

$$F_1 = \begin{bmatrix} 0 & 1 & 0 \\ 0 & 0 & 1 \\ -1 & -1 & -1 \end{bmatrix}, \quad F_2 = \begin{bmatrix} 0 & 1 & 0 \\ 0 & 0 & 1 \\ 0 & -1 & -1 \end{bmatrix}, \quad g_1 = \begin{bmatrix} 1 \\ 0 \\ 0 \end{bmatrix}, \quad g_2 = \begin{bmatrix} 0 \\ 1 \\ 0 \end{bmatrix}.$$

This example is borrowed from [33] where the authors considered the convergence of the state trajectories to an invariant set around a desired equilibrium. To solve the problem, they first have to introduce an auxiliary variable and to define the translated system with that variable. However, in Section 2.3.4, we comment and prove that the solution found for system (2.1) is a solution for system (2.17), so we do not need to define a translated model.

As it has been commented in Section 2.3.5, the optimization problem is non convex. Using a gridding procedure to fix the parameters μ and γ_i , the resulting optimization problem becomes convex and is solvable using SDP software as the CVX solver in Matlab (see [52]). The following numerical results are obtained:

$$\begin{aligned} \mu &= 0.7929, & \gamma_1 &= 10^{-5}, & \gamma_2 &= 1 - 10^{-5}, \\ W &= \begin{bmatrix} 5.6 & -4 & 2 \\ -4 & 6.2 & -4.2 \\ 2 & -4.2 & 7.4 \end{bmatrix} \cdot 10^{-10}, & \zeta_1 &= \begin{bmatrix} 0.1 \\ 0.4 \\ 0.37 \end{bmatrix}, & \zeta_2 &= \begin{bmatrix} 0.69 \\ -0.2 \\ -0.6 \end{bmatrix}. \end{aligned}$$

Figure 2.1 shows the trajectories of the system. The centers are indicated by the two red crosses. With the full view of the temporal evolution, we cannot see the ellipsoids drawing the attractor due to their reduced size. However, they appear after performing a zoom of them in the two windows. These views allow us to see the convergence of the trajectories toward the interior of the two ellipsoids, which differ only by their center.

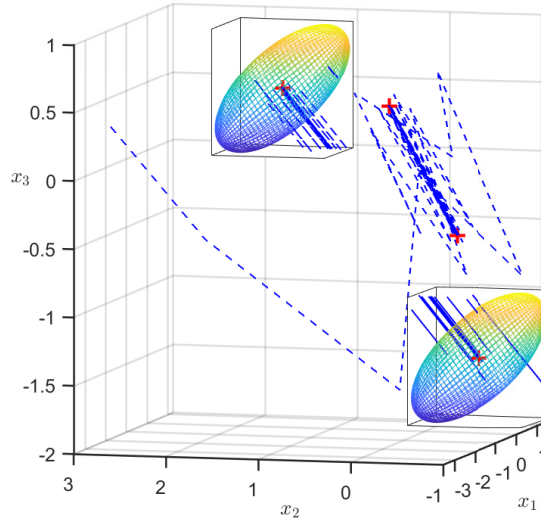

Figure 2.1: Trajectories of system (2.1) in the state space (Example 1). Two windows show the attractor located around the shifted centers.

An alternative interpretation of the previous figure is shown on Figure 2.2, where the evolution of $x(k) - \zeta_{\sigma(k)}$ with respect to k is plotted. One can see from this figure that the trajectories are indeed converging to the centers ζ_i .

It is also of interest to point out that the switching input signal tends to a periodic behaviour and that the state converges to an induced limit cycle $k \mapsto \zeta_{\sigma(k)}$.

2.4.2 Example 2

Let us study now Example 1 from [37]. The system considered is a switched affine system discretized using (2.22) with $T_s = 0.5$ and with the following matrices

$$F_1 = \begin{bmatrix} -5.8 & -5.9 \\ -4.1 & -4 \end{bmatrix}, \quad F_2 = \begin{bmatrix} 0.1 & -0.5 \\ -0.3 & -5 \end{bmatrix}, \quad g_1 = \begin{bmatrix} 0 & -2 \end{bmatrix}^\top, \quad g_2 = \begin{bmatrix} -2 & 2 \end{bmatrix}^\top.$$

Considering the gridding procedure used in Example 1 to find the parameters μ and γ_i for $i \in \{1, 2\}$, we have

$$\begin{aligned} \mu &= 0.997, & \gamma_1 &= 10^{-5}, & \gamma_2 &= 1 - 10^{-5}, \\ W &= \begin{bmatrix} 1.3 & 0.5 \\ 0.5 & 1.8 \end{bmatrix} \cdot 10^{-10}, & \zeta_1 &= \begin{bmatrix} -1.7 \\ 0.47 \end{bmatrix}, & \zeta_2 &= \begin{bmatrix} -0.54 \\ 0.33 \end{bmatrix}. \end{aligned}$$

Figure 2.3 shows the trajectory of the state $x(k)$ from the initial state toward the two shifted ellipses. Note that the ellipses depicted on this figure present such a reduced size that they are represented by a cross in each center, ζ_i . In addition, the dotted line \mathcal{S} , defined by $(x - \zeta_1)^\top W^{-1} (x - \zeta_1) = (x - \zeta_2)^\top W^{-1} (x - \zeta_2)$ portrays the switched

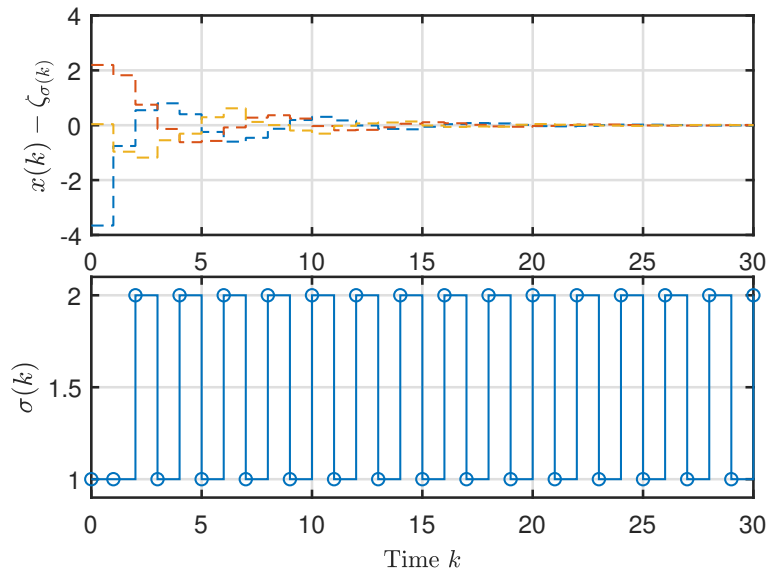

Figure 2.2: Evolution of $x(k) - \zeta_{\sigma(k)}$ with the switching function $\sigma \in \{1, 2\}$ computed at instant k (Example 1).

surface, which separates the space into two regions of different color. One can see which mode is active depending on which side the state $x(k)$ is.

Moreover, in the concerned figure, we compare the result given in [37] with our main result. The readers are able to see the different set sizes. The dashed ellipsoids represent the invariant set obtained in [37] while the invariant set obtained from Proposition 2.2 is illustrated by the crosses as commented above. Note that our approach provides a attractor at least 10^9 smaller than the one provided in [37].

Finally, one can note the decreasing value of the Lyapunov function on Figure 2.4. It is highlighted the invariant character of the attractor. Once $V(x(k))$ goes under 1, it remains under this value.

2.4.3 Example 3

Consider the discrete-time switched affine system described by the following matrices

$$A_1 = \begin{bmatrix} 1 & 0 \\ 0 & 0.5 \end{bmatrix}, \quad A_2 = 4\sqrt{2} \begin{bmatrix} \cos\left(\frac{\pi}{4}\right) & -\sin\left(\frac{\pi}{4}\right) \\ \sin\left(\frac{\pi}{4}\right) & \cos\left(\frac{\pi}{4}\right) \end{bmatrix}, \quad b_1 = \begin{bmatrix} 0.01 & 0 \end{bmatrix}^\top, \quad b_2 = \begin{bmatrix} 0 & 0 \end{bmatrix}^\top. \quad (2.23)$$

For this example, no solution to the optimization problem given in Proposition 2.2 has been found but different comments can still be made. On one hand, the gridding procedure is very rough so even if there exists a solution to the problem, the solution might be very hard to find depending on the system. On the other hand, the absence of solution can be explained by the restrictive assumptions made. Indeed, by considering a single matrix P and only two centers ζ_i to define the control Lyapunov function, we have made a strong assumption. With such restrictions, the state-space is separated by

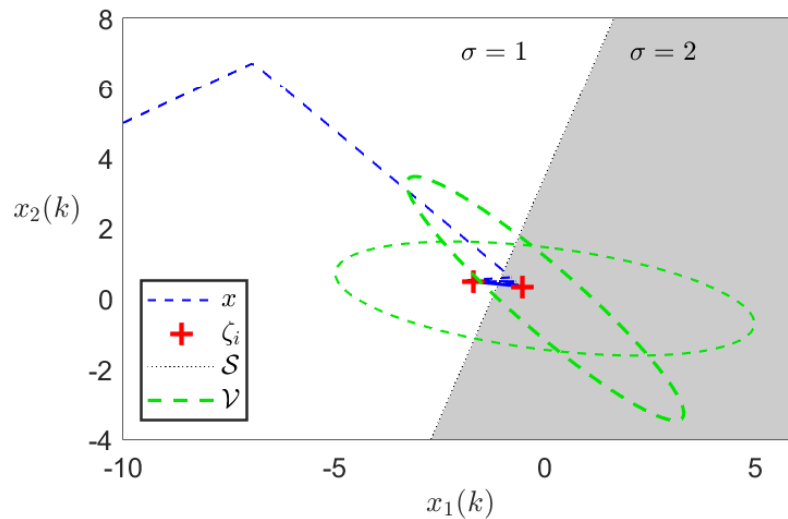

Figure 2.3: Trajectories of system (2.1) in the state space (Example 2). The switching surface (dotted gray line), the centers ζ_1 and ζ_2 (red crosses) and the invariant set (dashed green line) from [37].

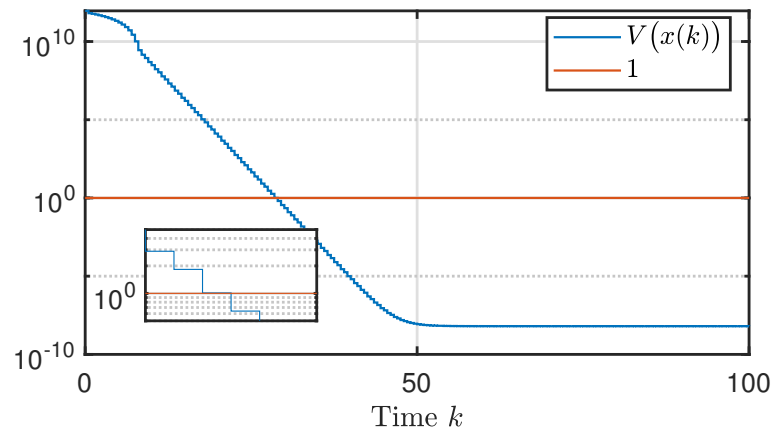

Figure 2.4: Evolution of the Lyapunov function $V(x(k))$ for Example 2.

a line into two regions: one region where the mode 1 is active ; the mode 2 in the other one. This seems unlikely to have a solution in general.

2.5 Conclusion

In this chapter, the problem of designing a stabilizing switched control law for switched affine systems has been addressed. Thanks to a new control Lyapunov function, arising from the stability analysis of switched systems, an accurate characterization of the attractor is formulated. The parameters of the control law are obtained through the solution of a non-convex optimization problem, that can be efficiently solved using a gridding procedure in the situation of 2-modes switched affine systems.

The proposed method is however not without problems: the non-convex optimization problem is hard to solve and the number of centers limits seriously the possible

solutions. But it may be easy to relax some other problems. For instance, to overcome the restriction pointed out in Example 3, the development of the method can also be made by considering several matrices P_i . This implies that the curves separating the state space could also be ellipsoid or hyperboloid. Also, the numerical results exposed in the first two examples lead to the reasonable idea of considering attractors that are defined by the union of several points. A formal proof of this needs to be investigated and will be the subject of the forthcoming chapters.

3

Introduction to limit cycles

In the first two chapters, we approached the stabilization of switched affine systems following the steps of the community working on the subject and we tried to improve the methods obtained so far by means of new tools – such as the new class of Lyapunov function in Chapter 2 – or by making new assumptions about the attractor. In doing so, we came to believe that the developed attractors could be reduced to the union of singleton, *i.e.* a set composed only of a finite number of points. This has led us to study limit cycles.

3.1 Overview of the literature

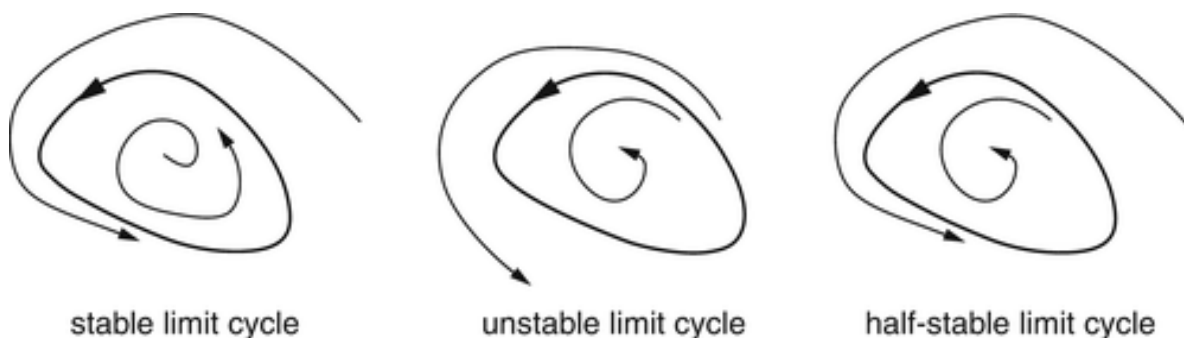

Figure 3.1: Different cases of limit cycle's stability [95]

Nonlinear systems can display oscillations of fixed amplitude and fixed period without external excitation. These oscillations are called limit cycles, or self-excited oscillations [94]. Limit cycles can also be referred as closed and isolated trajectory [95]. In any case, limit cycles represent an asymptotic behavior of dynamical systems and just like equilibrium points, they can be classified according to some properties, their stability for example. Looking at Figure 3.1, we can see different types of limit cycles:

- On the left, all the neighboring trajectories of the closed curve converge to it; this curve is a stable limit cycle.
- In the middle, the neighboring trajectories outside the closed curve spiral out while the neighboring trajectories inside the closed curve spiral in; this curve is a unstable limit cycle.

- One the right, the neighboring trajectories outside the closed curve approach the curve while the ones insides spiral away from the curve; this curve is a half-stable limit cycle.

Limit cycles are phenomena that can appear only in nonlinear systems [66, 95]. This is partially due to the fact that there does not exist isolated periodic trajectories in autonomous linear systems. In light of the precedent comment, Example 3.1 is proposed to illustrate the difference between the non-isolated periodic trajectories and the isolated ones, *i.e.* the limit cycles, but before, let us introduce the definition of isolated periodic trajectories.

Definition 3.1: Isolated periodic trajectory

Consider the autonomous periodic system

$$\begin{aligned} \dot{x}(t) &= f(x(t)), \quad t \in \mathbb{R}, \\ x_0 &\in \mathbb{R}^n, \end{aligned} \tag{3.1}$$

where $x(t)$ is a nontrivial^a periodic solution to (3.1), *i.e.* there exists $T > 0$ such that

$$x(t) = x(t + T), \quad \forall t \in \mathbb{R}.$$

The set $\mathcal{N}(x(t))$ denotes the neighborhood of the trajectory and is given by

$$\mathcal{N}(x(t)) = \left\{ y \in \mathbb{R}^n : \|y - x(t)\| \leq \kappa, \forall t \in [0, T) \right\},$$

where $\kappa \in \mathbb{R}$ is a positive constant arbitrary small. The periodic trajectory $x : \mathbb{R} \rightarrow \mathbb{R}^n$, $t \mapsto x(t)$ is *isolated* if there exists no other periodic trajectory $\tilde{x}(t)$, solution to (3.1) which belongs to $\mathcal{N}(x(t))$ for $t \in [0, T)$.

^aHere, the term nontrivial excludes the solutions of period $T = 0$, *i.e.* constant solutions, see [66].

Example 3.1: Periodic trajectories – the linear system case

Consider the linear system defined by the following equation

$$\dot{x}(t) = Fx(t), \quad x_0 \in \mathbb{R}^2. \tag{3.2}$$

Then, the natural response is $x(t) = e^{tF}x_0$ for all $t \in \mathbb{R}$. The solution is periodic if there exists $T \in \mathbb{R}$, $T > 0$ such that $x(t + T) = x(t)$. Hence, it follows from the system definition that the solution is indeed periodic if $e^{TF} = I_2$, where I_2 denotes the identity matrix of order 2. This holds true if and only if all the eigenvalues λ_i of F are pure-imaginary. However, the periodic trajectory $x : \mathbb{R} \rightarrow \mathbb{R}^n$, $t \mapsto e^{tF}x_0$ cannot be isolated since any other initial condition $\tilde{x}_0 = cx_0$, with $c \neq 1$ a constant, yields to a periodic trajectory that is kept in $\mathcal{N}(e^{tF}x_0)$. Figure 3.2a illustrates this example with $F = \begin{bmatrix} 0 & 1 \\ -1 & 0 \end{bmatrix}$. The matrix has only pure imaginary eigenvalues, $\lambda(F) = \pm j$, with j the complex variable, and we

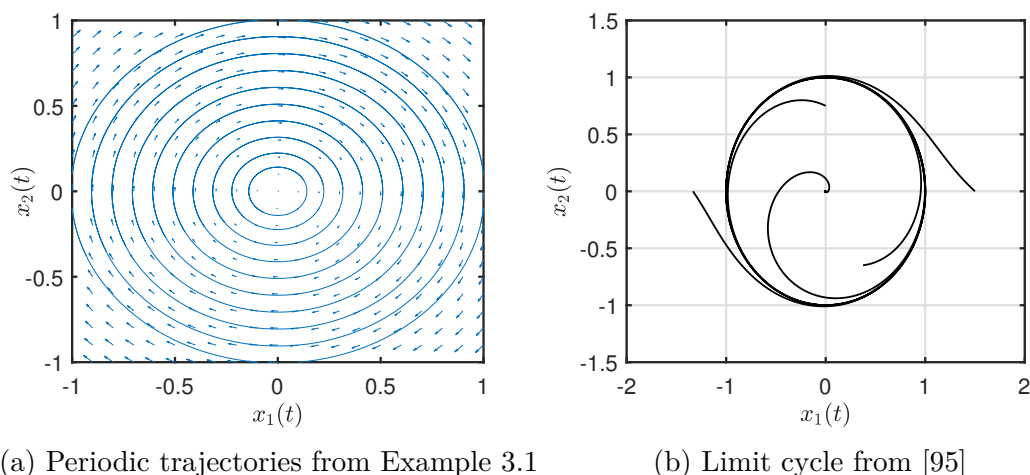

Figure 3.2: Comparative illustrations of periodic trajectories and isolated ones. In both case, the state of the system considered is of dimension 2, $x(t) \in \mathbb{R}^2$.

can find the period $T = 2\pi$. The figure shows multiple periodic trajectories for different initial conditions arbitrarily chosen. On the right, Figure 3.2b depicts a stable limit cycle, meaning that all the trajectories starting in its neighborhood will approach the curve as time tends to infinity, see [95, Section 7.1] for more details on the example.

The studies of limit cycles have been initiated by Henri Poincaré and have aroused great interest since then; a theorem is named after him and Ivar Bendixon who gives the complete proof later. It is stated as follows in [95].

Theorem 3.1: Poincaré-Bendixon Theorem

Suppose that:

- \mathcal{R} is a closed, bounded subset of the plane;
- $\dot{x} = f(x)$ is a continuously differentiable vector field on an open set containing \mathcal{R} ;
- \mathcal{R} does not contain any fixed points; and
- There exists a trajectory C that is “confined” in \mathcal{R} , in the sense that it starts in \mathcal{R} and stays in \mathcal{R} for all future time.

Then, either C is a closed orbit, or it spirals toward a closed orbit as time tends to infinity. In either case, \mathcal{R} contains a closed orbit.

Note that this theorem concerns only trajectories in the plane. The result is not easy to generalize since the closed trajectories can no longer partition the state space for systems of higher dimension. Now, for hybrid or switched systems, limit cycles have been mainly motivated by switched circuits [9, 51, 62, 82, 83] but Theorem 3.1 is

not easy to generalize to this context, one of the main difficulties is to determine the switching times. There are only few contributions available in the literature that tackle the asymptotic stabilization of switched affine system, in particular the discrete-case. We can cite [9] which deals with the design of the switching law for local stabilization of a desired limit cycle for switched affine systems in continuous-time by using the Poincaré map approach, we can also cite [36] who treats the stabilization of discrete-time switched affine systems to an *a priori* known limit cycle – a section in Chapter 4 discusses about this particular result – and then the same authors [39] treat the case in continuous-time.

3.2 Limit cycles of switched systems

In the previous section, some generalities about limit cycles for general nonlinear systems have been stated. However, the result given in Theorem 3.1 and the methods such as the Poincaré map are not easy to generalize to higher dimensional systems or hybrid systems, yet relevant in this context. This and the subsequent sections of the chapter are then devoted to give some definitions related to hybrid limit cycle for switched systems. In Section 3.3, a particular attention will be given on discrete switched affine systems. Let us first consider the switched systems given by

$$(3.3) \quad \begin{cases} \dot{x}(t) = f_{\sigma(t)}(x(t)), & t \in \mathbb{R}, \\ \sigma(t) = \sigma(t_k) \in \mathbb{K}, & \forall t \in [t_k, t_{k+1}), k \in \mathbb{N}, \\ x_0 \in \mathbb{R}^n, \end{cases}$$

where $\{f_i : i \in \mathbb{K}\}$ is a family of regular functions from \mathbb{R}^n to \mathbb{R}^n . In this representation, the vector $x(t) \in \mathbb{R}^n$ is the state of the system which evolves according to one of the K different functions. The active one is designated by the piecewise constant function $\sigma : [0, \infty) \rightarrow \mathbb{K}$, where the index set is defined by $\mathbb{K} := \{1, \dots, K\}$. This piecewise function is called the switching signal and at its discontinuities – called the switching instants $\{t_k\}_{k \in \mathbb{N}}$ – there is a change of dynamic for the evolution of the state $x(t)$. As it is said above, through this chapter, the objective is to define properly the hybrid limit cycle for the class of switched system. This class brought some particularities compared to other nonlinear system due to the multiple dynamics the state can follow. These particularities will be pointed out all along the following sections. This Chapter also aims to adapt the notion of limit cycles to the case of uncertain discrete switched affine systems in a second part.

3.2.1 Hybrid limit cycle definition

Definition 3.2: Hybrid limit cycle for a switched system

Consider the switched system (3.2), a hybrid limit cycle is a closed and isolated hybrid trajectory $s : \mathbb{R} \rightarrow \mathbb{K} \times \mathbb{R}^n$, $t \mapsto s(t) = (\sigma(t), x(t))$, which is a non-constant periodic solution of the switching dynamics (3.2).

Given $s(t) = (\sigma(t), x(t))$ a solution to (3.2), the solution is qualified as periodic if there exists $T \in \mathbb{R}$ such that the following equation holds

$$s(t + T) = s(t), \quad \forall t \in \mathbb{R}$$

If that periodic solution is non-constant (i.e. $T > 0$), the resulting trajectory is said to be closed. Note that such consideration excludes the different subsystems' equilibrium points of (3.2). In addition, an isolated trajectory means that there exists a neighborhood of this trajectory, which does not contain another closed trajectory. Hence, it requires to compare two hybrid trajectories $s(t) = (\sigma(t), x(t))$ and $\tilde{s}(t) = (\tilde{\sigma}(t), \tilde{x}(t))$ and it can be noticed that $s(t)$ can be in the neighborhood of $\tilde{s}(t)$ only if they share the same switching signal, i.e. $\sigma(t) = \tilde{\sigma}(t)$, because there is only a finite number of modes. This allows formulating the isolated property of the hybrid limit cycle $s(t) = (\sigma(t), x(t))$ as follows.

Property 3.1: Isolated periodic hybrid trajectory

Consider a periodic hybrid trajectory $s(t) = (\sigma(t), x(t))$ solution to (3.2), $s(t)$ is isolated if there exists $\kappa > 0$, such that, for any periodic trajectory $\tilde{s}(t) = (\sigma(t), \tilde{x}(t))$ solution to (3.2) with the same switching rule as $s(t)$, we have

$$\sup_{t \in \mathbb{R}} \|x(t) - \tilde{x}(t)\| > \kappa. \quad (3.4)$$

Proof. Consider a periodic hybrid trajectory $s(t) = (\sigma(t), x(t))$, with period $T > 0$. Let us assume that there exists another hybrid trajectory $\tilde{s}(t) = (\tilde{\sigma}(t), \tilde{x}(t))$ in the neighborhood of $s(t)$. By using the standard Euclidean distance shared over \mathbb{R}^n and over \mathbb{K} , we have that there exists a scalar $\kappa_0 > 0$ small enough, such that, $\forall \kappa \in]0, \kappa_0]$,

$$\sup_{t \in \mathbb{R}} (\|s(t) - \tilde{s}(t)\|) = \sup_{t \in \mathbb{R}} (\|\sigma(t) - \tilde{\sigma}(t)\| + \|x(t) - \tilde{x}(t)\|) \leq \kappa.$$

That implies in particular that $\sup_{t \in \mathbb{R}} (\|\sigma(t) - \tilde{\sigma}(t)\|) \leq \kappa$, and consequently that $\sigma(t) = \tilde{\sigma}(t)$, $\forall t \in \mathbb{R}$. The isolated property reads rigorously as follows:

$$\begin{aligned} & \exists \kappa_0 > 0, \forall \kappa \in]0, \kappa_0], \quad \text{s.t.} \quad \sup_{t \in \mathbb{R}} \|x(t) - \tilde{x}(t)\| \leq \kappa, \\ & \implies \nexists \tilde{T} \in \mathbb{R}, \tilde{T} \geq 0, \quad \text{s.t.} \quad \tilde{s}(t) = \tilde{s}(t + \tilde{T}). \end{aligned}$$

The contraposition of the latter implication writes:

$$\begin{aligned} & \forall \tilde{T} > 0, \quad \text{s.t.} \quad \tilde{x}(t) = \tilde{x}(t + \tilde{T}), \\ & \implies \exists \kappa > 0, \quad \text{s.t.} \quad \sup_{t \in \mathbb{R}} \|x(t) - \tilde{x}(t)\| > \kappa, \end{aligned}$$

which is the statement in Property 3.1. \square

3.2.2 Definitions related to the hybrid limit cycle

In the previous part, the augmented state $s(t)$ is composed of the state of the system, $x(t)$, and the switching signal $\sigma(t)$. The latter plays an important part in switching systems and explains why we do not only consider what we call *state limit cycle*. The distinction is specified in the following definition.

Definition 3.3: State limit cycle

For a hybrid limit cycle $t \mapsto s(t) = (\sigma(t), x(t))$ of period $T \in \mathbb{R}$, $T > 0$, the trajectory $\rho(t) = x(t)$, $\forall t \in [0, T)$ is called *state limit cycle*.

A similar definition can be formulated for the switching signal. Indeed, since that signal is a piecewise constant function taking its value in the set \mathbb{K} , we can extract the sequence of value during the limit cycle's period. Then, for the next definition, consider the strictly increasing sequence of time instants $\{t_k\}_{k \in \mathbb{N}}$ corresponding to the switching instants, *i.e.* the time instants when the active mode changes.

Definition 3.4: Cycle

For a hybrid limit cycle $t \mapsto s(t) = (\sigma(t), x(t))$ of period T , the *cycle* refers to the sequence $\nu = \{\sigma(t_k)\}_{k=1, \dots, N}$ of period $N \in \mathbb{N}$, $N > 1$.

Remark 2 (Relation between the periods N and T). The period N corresponds to the number of switches during the period of time T . Therefore, we can identify the time periods during which the mode i is active, we denote them $\Delta T(k, \sigma(t_k))$ with $\sigma(t) = i$, $\forall t \in [t_k, t_k + \Delta T(k, \sigma(t_k))]$. Then, we have the following relation

$$T = \sum_{k=1, \dots, N} \Delta T(k, \sigma(t_k)). \quad (3.5)$$

In the sequel, we have for objective to design the switching rule in order to stabilize the system, so the relation is simplified because we will not consider the switching instants anymore, but the computation instants. Either in the case of periodic time-triggered control strategy or considering directly the discrete-time system, the sampling period is T_s with $t_{k+1} - t_k = T_s$. Hence, (3.5) becomes $T = NT_s$.

Being a periodic sequence, the cycle of period N verifies the following property

$$\nu(\ell + N) = \nu(\ell), \quad \forall \ell \in \mathbb{N},$$

and it follows the definition of the set of cycles as follows.

Definition 3.5: Set of cycles

Denote the set of cycles from \mathbb{N} to \mathbb{K} by

$$\mathfrak{C} := \left\{ \nu : \mathbb{N} \rightarrow \mathbb{K}, \text{ s.t. } \exists N \in \mathbb{N}, N > 1, \forall \ell \in \mathbb{N}, \nu(\ell + N) = \nu(\ell) \right\}. \quad (3.6)$$

In addition to the previous definitions, given a cycle $\nu \in \mathfrak{C}$, the notation N_ν stands for its minimum period and is defined by

$$N_\nu = \min N \in \mathbb{N}, N > 1 \text{ s.t. } \nu(\ell + N) = \nu(\ell), \forall \ell \in \mathbb{N}. \quad (3.7)$$

Besides, to ease the readability, it is also useful to consider the modulo operator, with 1 as offset, associated to ν so that N_ν is the modulus. More formally, for any $i \in \mathbb{N}$, $i \geq 1$:

$$\lfloor i \rfloor_\nu = ((i - 1) \bmod N_\nu) + 1.$$

In particular, it yields to the following equalities

$$\begin{aligned} \lfloor i \rfloor_\nu &= i, \quad \forall i \in \mathfrak{D}_\nu := \{1, \dots, N_\nu\}, \\ \lfloor N_\nu + 1 \rfloor_\nu &= 1, \end{aligned}$$

where \mathfrak{D}_ν is the minimum domain of ν . Lastly, it might be useful to talk about cycles with a specific period so we denote \mathfrak{C}_N the set of cycles that are N -periodic:

$$\mathfrak{C}_N := \left\{ \nu : \mathbb{N} \rightarrow \mathbb{K}, \text{ s.t. } \forall \ell \in \mathbb{N}, \nu(\ell + N) = \nu(\ell) \right\}.$$

At this stage, nothing is said about the similarities between the cycles within a same set. This will be the subject of a following section (see Section 3.4), properties on periodic sequences together with the literature on periodic systems are useful to reduce the number of cycles to study. But before, the next section proposes the definitions adapted to trajectories in discrete-time.

3.2.3 Hybrid limit cycle in discrete-time

Consider now the case of a switched system in discrete-time defined by the following

$$\begin{cases} x(k+1) = f_{\sigma(k)}(x(k)), & \forall k \in \mathbb{N}, \\ \sigma(k) \in \mathbb{K}, \\ x_0 \in \mathbb{R}^n. \end{cases} \quad (3.8)$$

The hybrid nature of the following definition comes from the fact that the switching signal can only has value in the finite set \mathbb{K} contrary to the state that lives in \mathbb{R}^n . Hence, closely to the continuous-time case, we have the following definition.

Definition 3.6: Discrete hybrid limit cycle

For a switched system in discrete-time, a hybrid limit cycle is a closed and isolated hybrid trajectory $s : \mathbb{N} \rightarrow \mathbb{K} \times \mathbb{R}^n$, $k \mapsto s(k) = (\sigma(k), x(k))$, which is a non-constant periodic solution of the switching dynamics (3.8).

It follows that the trajectory $s(k)$ is closed if there exists $N > 1$ such that,

$$s(k + N) = s(k), \quad \forall k \in \mathbb{N},$$

and we can adapt Property 3.1 to the discrete-time case in following way

Property 3.2: Isolated periodic hybrid trajectory – Discrete case

Consider a periodic hybrid trajectory $s(k) = (\sigma(k), x(k))$ solution to (3.8), $s(k)$ is isolated if there exists $\kappa > 0$, such that, for any periodic trajectory $\tilde{s}(k) = (\sigma(k), \tilde{x}(k))$ solution to (3.8) with the same switching rule as $s(k)$, we have

$$\sup_{k \in \mathbb{N}} \|x(k) - \tilde{x}(k)\| > \kappa. \quad (3.9)$$

Proof. The proof is omitted since it is similar to the proof of Property 3.1. \square

Definition 3.7: Discrete state limit cycle

For a discrete hybrid limit cycle $k \mapsto s(k) = (\sigma(k), x(k))$ of period $N \in \mathbb{N}$, $N > 1$, the sequence $\rho = \{x(k)\}_{k=1, \dots, N}$ is called *state limit cycle*.

It is not necessary to reformulate the remaining Definitions 3.4 and 3.5 related to the switching signals since the only differences are about the switching $\{t_k\}_{k \in \mathbb{N}}$ replaced by the discrete time. However, compared to the continuous case, the switching sequence exhibits the repetition of the same mode.

3.2.4 Intersection within the state limit cycle

Compared to other nonlinear systems, switched nonlinear systems can show particular trajectories. Indeed, the system has multiple modes and therefore, the trajectories can be closed and not-simple, *i.e.* can intersects themselves. Moreover, if this type of trajectory is isolated, we are facing a hybrid limit cycle. For instance, Figure 3.3 shows an example where the curve goes through the origin twice per period. Figure 3.3 also shows that the trajectories approaches the limit cycle regardless the initial condition. To obtain such figure, the system considered is a periodic switching affine system: a switching affine system with a periodic switching signal.

Remark 3. This type of trajectories can occur both in the continuous and the discrete case.

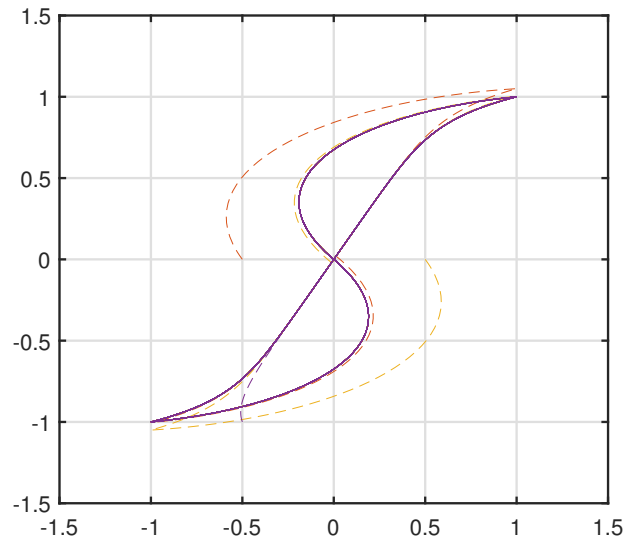

Figure 3.3: Illustration of a periodic trajectory crossing itself

3.3 Particular case of switched affine systems

From now on, we let aside general switched systems to focus on switched affine systems which are our main interest along this memoire. More particularly, we are interesting in switched affine systems constrained to have a switching rule periodically updated. This consideration is especially motivated by practical situations where the implemented control laws are computed at periodic instants.

3.3.1 System data and problem formulation

Consider the continuous-time switched affine system with a periodic time-triggered switching signal σ given by

$$\begin{cases} \dot{x}(t) = F_{\sigma(t)}x(t) + g_{\sigma(t)}, & t \in \mathbb{R}, \\ \sigma(t) = \sigma(t_k) \in \mathbb{K}, & \forall t \in [t_k, t_{k+1}), k \in \mathbb{N}, \\ x_0 \in \mathbb{R}^n, \end{cases} \quad (3.10)$$

where $x(t) \in \mathbb{R}^n$ is the state vector and x_0 its initial condition and $\sigma(t)$ is a sampled-data switching signal which indicates the active mode in each time period $[t_k, t_{k+1})$. The sequence $\{t_k\}_{k \in \mathbb{N}}$ is a strictly increasing sequence of time instants for which it is assumed that there exists a positive scalar T_s corresponding to the sampling period such that the difference between two successive sampling instants verifies

$$t_{k+1} - t_k = T_s > 0, \quad \forall k \in \mathbb{N} \quad (3.11)$$

so that the sequence $\{t_k\}_{k \in \mathbb{N}}$ tends to infinity as k tends to infinity. Integrating (3.10) over a sampling period $[t_k, t_{k+1})$ yields

$$x(\tau) = \Phi_i(\tau)x(t_k) + \Gamma_i(\tau), \quad i \in \mathbb{K}, \tau \in [t_k, t_{k+1}), \quad (3.12)$$

where the timer-dependent matrices Φ_i and Γ_i are given by

$$\Phi_i(\tau) := e^{F_i\tau} \quad \text{and} \quad \Gamma_i(\tau) := \int_0^\tau e^{F_i(\tau-s)} g_i ds, \quad i \in \mathbb{K}, \tau \in [t_k, t_{k+1}). \quad (3.13)$$

Another solution is to consider directly a discretized switched affine system given by

$$\begin{cases} x(k+1) = A_{\sigma(k)}x(k) + b_{\sigma(k)}, \\ \sigma(k) \in \mathbb{K}, \\ x_0 \in \mathbb{R}^n, \end{cases} \quad k \in \mathbb{N}, \quad (3.14)$$

In this representation, the time instants are reduced to the index $k \in \mathbb{N}$. In any case, the systems are composed of K subsystems defined through matrices F_i and g_i in the continuous-time model ; A_i and b_i in discrete-time. The relation between the two models can be simplified to the relation between the matrices by fixing in equation (3.13) the variable $\tau = T_s$ where T_s is the sampling period. Hence, we have

$$A_i = \Phi_i(T_s) \quad \text{and} \quad b_i = \Gamma_i(T_s), \quad \forall i \in \mathbb{K}. \quad (3.15)$$

While the conditions of existence of limit cycles are usually based on the use of the Poincaré map or related tools, here, the switching control law being a periodic sequence, we can take advantage of the literature on periodic systems.

3.3.2 Necessary and sufficient conditions of existence

In this section, the objective is to characterize the limit cycles of system (3.14). We take advantage of the associated periodic switching law and benefits of the discrete-time (linear) periodic system literature, see for instance [12, 15, 32, 100] or the survey [13]. A limit cycle having a periodic switching law, we will determine necessary and sufficient conditions to the existence of a limit cycle for a given cycle ν . This result is provided in the two following lemmas for the sake of clarity and they generalize the necessary and sufficient condition presented in [82] to the case of an arbitrary number of modes and an arbitrary period N_ν . First, if there exists a discrete hybrid limit cycle $s(k) = (\sigma(k), x(k))$ of period N_ν such that $\sigma(k) = \nu(k + \delta)$ with $\nu \in \mathfrak{C}$ and δ a constant shift, then the state limit cycle is defined by:

$$\rho_{[i+1]_\nu} = A_{\nu(i)}\rho_i + b_{\nu(i)}, \quad \forall i \in \mathfrak{D}_\nu, \quad (3.16)$$

with matrices A_i 's and b_i 's defining the switched affine system (3.14). A schematic representation is given on Figure 3.4 to illustrate the evolution of the state limit cycle. Relations (3.16) can be reformulated into the following matrix affine equation (3.17) by using a cyclic augmented representation inspired by [44, 100]

$$(I_{nN_\nu} - \mathbf{A}_\nu)\rho = \mathbf{B}_\nu, \quad (3.17)$$

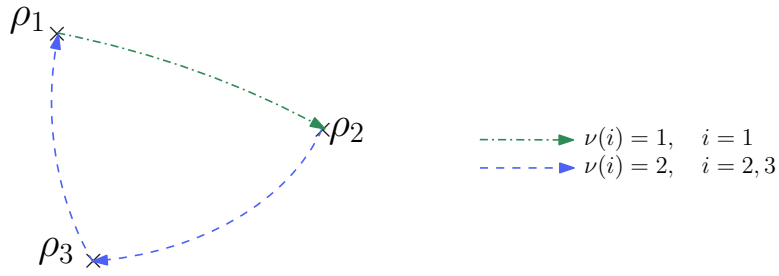

Figure 3.4: Schematic representation of a limit cycle for a system (3.14) with $K = 2$ modes. Here we have $\nu : \{1, 2, 2\}$, ν is of period $N_\nu = 3$. The closed state trajectory is composed of the vectors ρ_i that verify condition (3.16).

where the components of the state limit cycle are gathered in the vector ρ . This vector and the cyclic augmented matrices \mathbf{A}_ν and \mathbf{B}_ν are given by

$$\mathbf{A}_\nu = \begin{bmatrix} 0 & \dots & 0 & A_{\nu(N_\nu)} \\ A_{\nu(1)} & \ddots & 0 & 0 \\ \vdots & \ddots & \ddots & \vdots \\ 0 & \dots & A_{\nu(N_\nu-1)} & 0 \end{bmatrix}, \quad \rho = \begin{bmatrix} \rho_1 \\ \rho_2 \\ \vdots \\ \rho_{N_\nu} \end{bmatrix}, \quad \mathbf{B}_\nu = \begin{bmatrix} b_{\nu(N_\nu)} \\ b_{\nu(1)} \\ \vdots \\ b_{\nu(N_\nu-1)} \end{bmatrix}.$$

Lemma 3.1: Existence and Uniqueness of a periodic solution

For a given cycle $\nu \in \mathfrak{C}$, we can define the matrix $\Phi_{\nu(\ell)}$, called the monodromy matrix at time $\ell \in \mathbb{N}$, given by

$$\Phi_{\nu(\ell)} := \prod_{\iota=\ell+1}^{\ell+N_\nu} A_{\nu(\iota)} = A_{\nu(\ell+N_\nu)} A_{\nu(\ell+N_\nu-1)} \dots A_{\nu(\ell+1)}, \quad \ell \in \mathbb{N}. \quad (3.18)$$

The two following statements are equivalent and are necessary and sufficient conditions to the uniqueness of the solution to (3.17)

- Matrix $(I_{nN_\nu} - \mathbf{A}_\nu)$ is non-singular .
- Matrix $\Phi_{\nu(0)}$ does not have 1 as eigenvalue.

Proof. Due to the construction of the matrix \mathbf{A}_ν , the monodromy matrix $\Phi_{\nu(\ell)}$ and matrix \mathbf{A}_ν have a close relation. Firstly, it is known for discrete-time periodic systems that the monodromy matrix $\Phi_{\nu(\ell)}$ has a spectrum that does not depend on the time ℓ (see for instance [10, Section 3.1]). Its eigenvalues are generally called characteristic multipliers. Secondly, the spectrum of the cyclic augmented matrix \mathbf{A}_ν is the set of all N_ν -roots of the n eigenvalues of the monodromy matrix $\Phi_{\nu(0)}$ (see the argument of [12, page 322, Section 3.2] or [100, Proof of Theorem 4]), *i.e.* according to [77, Lemma 4], the following equation holds (see Annexe B for more details).

$$\det(zI_{nN_\nu} - \mathbf{A}_\nu) = \det(z^{N_\nu} I_n - \Phi_{\nu(0)}).$$

Hence, we infer that matrix $(I_{nN_\nu} - \mathbf{A}_\nu)$ is non-singular if and only if the spectrum

of the monodromy matrix $\Phi_{\nu(0)}$ does not contain the eigenvalue 1. It is known that $(I_{nN_\nu} - \mathbf{A}_\nu)$ being non-singular ensures the uniqueness of the solution to (3.17). That concludes the proof. \square

However, even if the equation (3.17) has an unique solution under the conditions stated, it is not enough to ensure the existence of a limit cycle $s(k) = (\sigma(k), x(k)) = (\nu(k + \delta), \rho_{[k+\delta]_\nu})$ where δ is a possible cyclic shift. To exist, the state trajectory needs to be isolated as stated in Definition 3.2 and Property 3.1. The next Lemma adds the adequate conditions.

Lemma 3.2: Existence and Uniqueness of a limit cycle related to ν

A cycle $\nu \in \mathfrak{C}$ generates a unique limit cycle for system (3.14) if and only if 1 is not an eigenvalue of matrix $\Phi_{\nu(0)}^M$, where $\Phi_{\nu(\ell)}$ is the monodromy matrix defined in (3.18) and M is any strictly positive integer.

Proof. Sufficient condition: Let us assume that 1 is not an eigenvalue of matrix $\Phi_{\nu(0)}^M$, where M is any strictly positive integer. Therefore, 1 is not a characteristic multiplier of $\Phi_{\nu(0)}$ and referring to Lemma 3.1, we deduce that the solution to (3.17) exists and is unique and $(\nu(k), \rho_{[k]_\nu})$ is a periodic orbit. To be a limit cycle, this periodic orbit must be isolated. In Property 3.1 was noting that a periodic solution in the neighborhood of this solution shares the same cycle ν . Then, the only possible neighboring trajectory is $(\bar{\nu}(k), \bar{\rho}_{[k]_{\bar{\nu}}})$ where $\bar{\nu}$ is a M -repetition of the cycle ν so that we have $\bar{\nu}(\ell) = \nu([\ell]_\nu)$, $\ell \geq 1$. In this case, we have $\bar{\nu} \in \mathfrak{C}_N$ with $N = MN_\nu$ and $\bar{\rho} \in \mathbb{R}^{nMN_\nu}$ solution to

$$(I_{nMN_\nu} - \mathbf{A}_{\bar{\nu}}) \bar{\rho} = \mathbf{B}_{\bar{\nu}} = \mathbf{1}_M \otimes \mathbf{B}_\nu.$$

But, since ρ is solution to (3.17), it is also solution to

$$(I_{nMN_\nu} - \mathbf{A}_{\bar{\nu}}) \mathbf{1}_M \otimes \rho = \mathbf{1}_M \otimes \mathbf{B}_\nu,$$

therefore,

$$(\mathbf{1}_M \otimes \rho - \bar{\rho}) \in \text{Ker}(I_{nMN_\nu} - \mathbf{A}_{\bar{\nu}}). \quad (3.19)$$

The eigenvalues of $\mathbf{A}_{\bar{\nu}}$ are the MN_ν -roots of $\Phi_{\bar{\nu}(0)} = \Phi_{\nu(0)}^M$. So, based on the assumption that $\Phi_{\nu(0)}^M$ does not admits 1 as eigenvalue, so don't matrix $\mathbf{A}_{\bar{\nu}}$. It means the kernel in equation (3.19) is reduced to the null vector and that the two trajectories are the same. The periodic solution induced by ν exists and the limit cycle is unique.

Necessary condition: In order to prove this implication, we consider the contraposition approach. Assume that there exists a positive integer M such that $\Phi_{\nu(0)}^M$ admits 1 as eigenvalue. Let us set M as the lowest integer satisfying this constraint. Two cases may occur, i.e. $M = 1$ and $M > 1$:

- In the case where $M = 1$, there is no solution or an infinite number of solutions, depending on the fact that \mathbf{B}_ν belongs or not in $\text{Span}(I_{nN_\nu} - \mathbf{A}_\nu)$. That implies that there does not exist a periodic solution of period N_ν or it is not isolated.

- Assume now that $M > 1$, we infer that there exists a solution $\rho \in \mathbb{R}^{nN_\nu}$ of length N_ν . We can now build an M -repetition of this periodic solution, that is $\mathbb{1}_M \otimes \rho$. Due to the assumption, there exists a unitary vector $\tilde{\rho} \in \mathbb{R}^{nMN_\nu}$, $\tilde{\rho} \neq 0$ in the kernel of $(I_{nMN_\nu} - \mathbf{A}_{\bar{\nu}})$, with $\bar{\nu}$, the MN_ν -periodic cycle defined by $\bar{\nu}(\ell) = \nu(\lfloor \ell \rfloor_\nu)$, $\forall \ell \geq 1$. For any small scalar $\kappa > 0$, $\mathbb{1}_M \otimes \rho + \frac{1}{2}\kappa\tilde{\rho}$ is related to a periodic solution in the neighborhood of ρ , which is not isolated and ends the proof. □

Similarly to Proposition 2.1 on page 25, it can be stressed out that the limit cycles are intrinsic and therefore, do not depend of any change of coordinate. In the context of stabilization of switched affine systems, it is usual to perform a change of the coordinates in order to locate the reference position at the origin. In light of this remark, one may wonder whether a limit cycle of the system is affected by this transformation. Let us then introduce a general formulation of an affine change of coordinates given by $z = Tx + w$, where T is a nonsingular matrix and where w is a vector of \mathbb{R}^n . Then, the following proposition holds.

Proposition 3.1: Invariance of limit cycles wrt. the realization

Assume that a cycle ν generates a limit cycle for system (3.14), with the components of the state limit cycle denoted $\{\rho_i\}_{i \in \mathfrak{D}_\nu}$. Then, for any non-singular matrix T and any vector $w \in \mathbb{R}^n$, $\{T\rho_i + w\}_{i \in \mathfrak{D}_\nu}$ are the components of the state limit cycle associated to the same cycle for the same system (3.14) but expressed in the new coordinates $z = Tx + w$.

Proof. Simple manipulations of (3.16) conclude the proof. See the proof of Proposition 2.1 for more details. □

3.4 Discussion on cycles

3.4.1 Reduction of the number of candidate cycles

The search of a limit cycle of system (3.14) can be guided by an objective. Among the possible objectives, we can cite, for instance and not exhaustively,

- the existence of a limit cycle of shortest period;
- a state limit cycle with a given maximal distance to a fixed center or optimizing robustness margins (see Chapter 5).

Such an algorithm can be performed by increasing step by step the period N_ν . However, in the situation where system (3.14) admits K modes, the number of possible N_ν -periodic cycles increases exponentially with the number of modes, since there are K^{N_ν} . Thus, it is important to understand if some of them are redundant and can be removed. In this section, we propose several simple rules, stated in Corollaries 3.1 and 3.2 (based on Lemmas 3.1 and 3.2), to avoid redundant limit cycles.

Corollary 3.1: Circular permutation

For any cycle $\nu \in \mathfrak{C}$, for which 1 is not a characteristic multiplier of $\Phi_{\nu(0)}$ and for any integer $M > 0$, the cycle $\bar{\nu}$ given by

$$\bar{\nu}(\ell) = \nu(\ell + M), \quad \forall \ell \in \mathbb{N},$$

is N_ν -periodic and associated to a unique limit cycle, which is a circular permutation of the limit cycle related to ν .

Proof. The proof is straightforward by noting that $\bar{\nu}$ is a shifted version of ν , by recalling that the spectrum of the monodromy matrix $\Phi_{\bar{\nu}(\ell)} = \Phi_{\nu(\ell+M)}$ does not depend on ℓ and by re-ordering the vectors ρ_i 's. \square

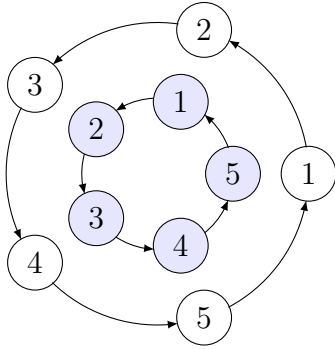

Figure 3.5: Illustration of Corollary 3.1

The figure on the left is an illustration of Corollary 3.1. The inner circle shows the same cycle but shifted by $M = 1$.

Corollary 3.2: Concatenation

For any integer $M \in \mathbb{N}$, $M > 0$ and a cycle $\nu \in \mathfrak{C}$, for which $\Phi_{\nu(0)}$ does not admit an M -root of unity as characteristic multiplier, consider the MN_ν -periodic cycle $\bar{\nu}$ given by

$$\bar{\nu}(\bar{\ell}) = \nu(\lfloor \bar{\ell} \rfloor_\nu), \quad \forall \bar{\ell} = 1, \dots, MN_\nu.$$

Then, $\bar{\nu}$ does not admit an M -root of unity as characteristic multiplier, the cycle $\bar{\nu}$ is associated to the unique limit cycle, which consists in the M -times concatenation of the limit cycle related to ν .

Proof. The monodromy matrix related to cycle $\bar{\nu}$ at time 0 satisfies $\Phi_{\bar{\nu}(0)} = \Phi_{\nu(0)}^M$. Matrix $\Phi_{\bar{\nu}(0)}$ admits 1 as eigenvalue if and only if $\Phi_{\nu(0)}$ admits an M -root of unity as eigenvalue. Lemma 3.2 allows to conclude. It is easy to check that the M times concatenation of the limit cycle associated to ν is this unique limit cycle, when it exists. \square

3.4.2 Union of closed trajectories

Contrary to the two previous corollaries, the following one cannot help to reduce the number of existing limit cycles. However, the presence of intersections (as commented

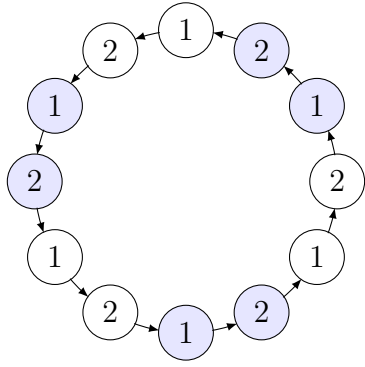

Figure 3.6: Illustration of Corollary 3.2

The figure on the left is an illustration of Corollary 3.2. The sequence $\{1, 2\}$ is repeated M -times with $M = 6$.

in Section 3.2.4) has an impact on the design of the switching rules (see Theorem 4.2 in Chapter 4), so it is important to detect whether they exist.

Corollary 3.3: Intersection within the state limit cycle

Consider a cycle $\nu \in \mathfrak{C}$ that generates a limit cycle $k \mapsto (\nu(k), \rho_{\lfloor k \rfloor_\nu})$ where $\{\rho_i\}_{i \in \mathfrak{D}_\nu}$ are determined by (3.17). If there exist $(i_0, i_1) \in \mathfrak{D}_\nu^2$, $i_1 > i_0$, such that $\rho_{i_0} = \rho_{i_1}$, then the state limit cycle $\{\rho_i\}_{i \in \mathfrak{D}_\nu}$ is the union of two closed trajectories, associated with cycles of periods strictly less than N_ν .

Proof. Based on the cycle ν , the proof is obtained by designing the two following cycles ν_1 and ν_2 .

ν_1 is defined as a $N_{\nu_1} = (i_1 - i_0)$ -periodic cycle given by $\nu_1(\ell) = \nu(i_0 - 1 + \ell)$, $\ell = 1, \dots, (i_1 - i_0)$ and is associated with the periodic trajectory $\{\rho_{i_0}; \rho_{i_0+1}; \dots; \rho_{i_1}\}$. ν_2 is defined as a $N_{\nu_2} = (N_\nu - i_1 + i_0)$ -periodic cycle given by $\nu_2(\ell) = \nu(i_1 - 1 + \ell)$, $\ell = 1, \dots, (N_\nu - i_1 + i_0)$ and is associated with the periodic trajectory $\{\rho_{i_1}; \rho_{i_1+1}; \dots; \rho_{N_\nu}; \rho_1; \dots; \rho_{i_0}\}$. \square

Let us illustrate this corollary by taking a simple example. Consider a cycle $\nu \in \mathfrak{C}_4$ that generates a limit cycle where the components of the state limit cycle $\{\rho_i\}_{i=1, \dots, 4}$ are solution to $(I_{nN_\nu} - \mathbf{A}_\nu)\rho = \mathbf{B}_\nu$, therefore, the system of equations (3.16) can be written as follows

$$\begin{aligned} \rho_1 &= A_{\nu(4)}\rho_4 + b_{\nu(4)}, \\ \rho_2 &= A_{\nu(1)}\rho_1 + b_{\nu(1)}, \\ \rho_3 &= A_{\nu(2)}\rho_2 + b_{\nu(2)}, \\ \rho_4 &= A_{\nu(3)}\rho_3 + b_{\nu(3)}. \end{aligned}$$

Assume now that we have $\rho_2 = \rho_4$, it follows that we have the following equalities

$$\begin{aligned} \rho_1 &= A_{\nu(4)}\rho_2 + b_{\nu(4)}, & \text{and} & & \rho_3 &= A_{\nu(2)}\rho_4 + b_{\nu(2)}, \\ \rho_2 &= A_{\nu(1)}\rho_1 + b_{\nu(1)}, & & & \rho_4 &= A_{\nu(3)}\rho_3 + b_{\nu(3)}. \end{aligned}$$

Based on these systems, we can deduce that the cycle $\nu_1 = \{\nu(1), \nu(4)\}$ generates the periodic sequence $\{\rho_1, \rho_2\}$ and the cycle $\nu_2 = \{\nu(2), \nu(3)\}$ generates the periodic se-

quence $\{\rho_3, \rho_4\}$.

Note that all the switched affine systems based on time-periodic switching signals (*e.g.*, $\sigma(k) = \nu(k - \delta)$ where δ is any integer belonging to \mathfrak{D}_ν) will not be affected. Starting from ρ_i , $i \in \mathfrak{D}_\nu$, the state will run through the state limit cycle associated to ν indefinitely. However, the state-feedback closed-loop switched affine systems might face some problems.

3.5 Conclusion

In this chapter, a short overview of the basic notions of limit cycles was presented. Then, a particularization of these concepts to the case of switched affine systems has been formalized. Preliminary results on the existence and uniqueness of a state limit cycle associated with a given cycle (*i.e.* periodic switching signals) were presented along with some illustrative examples.

Up to now, the study only focused on the existence of state limit cycles and the problem of its stability analysis or stabilization has not been considered yet. The next chapter aims at filling this gap and at providing open- and closed-loop control laws ensuring the convergence of switched affine systems to one of its limit cycles. In particular, the switching control laws to be established will no longer necessarily be periodic or time-dependent.

4

Stabilization to limit cycles

4.1 Introduction

In the previous chapter, we have introduced the notion of hybrid limit cycles for switched systems including definitions both in continuous-time and discrete-time, conditions of their existence and details on switching sequences. In the third part 3.3, a particular attention has been paid to switched affine systems with discrete-time dynamics.

This chapter aims at presenting a part of the contributions by following these different items:

- First, we will introduce an additional sufficient condition to the existence of hybrid limit cycle for switched affine systems with a periodic time-triggered switching control law.
- Second, two stabilizing switching rules are presented with detailed proof in Section 4.2. It is followed by a section dedicated to comments on the proposed results and deep comparisons with the existing literature.
- Lastly, Section 4.4 focuses on the optimal selection of a cycle based on cost functions while Section 4.5 presents different examples in order to illustrate the previous sections.

4.2 Design of the switching rules

4.2.1 Preliminaries

Let us consider the same system, that is recalled here to ease the reading of the chapter.

$$\begin{cases} x(k+1) = A_{\sigma(k)}x(k) + b_{\sigma(k)}, & k \in \mathbb{N}, \\ \sigma(k) \in u(x(k)) \subseteq \mathbb{K}, \\ x_0 \in \mathbb{R}^n, \end{cases} \quad (4.1)$$

where $x(k) \in \mathbb{R}^n$ is the state vector, $\sigma(k) \in \mathbb{K} = \{1, 2, \dots, K\}$ characterizes the active mode, $u(x(k))$ is the switching rule to be designed and $k \in \mathbb{N}$ stands for the time variable. In (4.1), the matrices (A_i, b_i) for $i \in \mathbb{K}$ are supposed to be known, constant and

of suitable dimension.

In Chapter 3, two Lemmas successively present the conditions of existence of a periodic solution and a hybrid limit cycle for system (4.1). These conditions are based on the characteristic multipliers of the monodromy matrix for a given cycle. The following proposition gives an additional condition – only sufficient – to the existence and uniqueness of a limit cycle for system (4.1).

Proposition 4.1: LMI-based sufficient condition of existence

A cycle ν in \mathfrak{C} generates a unique limit cycle $k \mapsto (\nu(k), \rho_{[k]_\nu})$ for system (4.1) if there exist matrices $\{P_i\}_{i \in \mathfrak{D}_\nu}$ in \mathbb{S}^n , such that

$$P_i \succ 0, \quad A_{\nu(i)}^\top P_{[i+1]_\nu} A_{\nu(i)} - P_i \prec 0, \quad \forall i \in \mathfrak{D}_\nu = \{1, \dots, N_\nu\}. \quad (4.2)$$

Proof. The proof is based on the result given by Lemma 3.2. Indeed, consider $\bar{P} = \text{diag}(P_i)_{i=1, \dots, N_\nu}$ with matrices $\{P_i\}_{i \in \mathfrak{D}_\nu}$ solution to (4.2), therefore, simple calculations show that

$$\mathbf{A}_\nu^\top \bar{P} \mathbf{A}_\nu - \bar{P} = \text{diag}\left(A_{\nu(i)}^\top P_{[i+1]_\nu} A_{\nu(i)} - P_i\right)_{i=1, \dots, N_\nu} \prec 0, \quad (4.3)$$

where \mathbf{A}_ν is the cyclic augmented matrix and is given by

$$\mathbf{A}_\nu = \begin{bmatrix} 0 & \dots & 0 & A_{\nu(N_\nu)} \\ A_{\nu(1)} & \ddots & 0 & 0 \\ \vdots & \ddots & \ddots & \vdots \\ 0 & \dots & A_{\nu(N_\nu-1)} & 0 \end{bmatrix}.$$

Since the eigenvalues of the matrix \mathbf{A}_ν are the N_ν -roots of the n eigenvalues of $\Phi_{\nu(0)}$ (as commented in the proof of Lemma 3.1) and \mathbf{A}_ν is Schur stable since it is solution to (4.3), the value 1 does not belong to the spectrum of $\Phi_{\nu(0)}^M$ for any $M \in \mathbb{N} \setminus \{0\}$. According to Lemma 3.2, there exists a unique limit cycle associated with the cycle ν . The components of the state limit cycle are gathered in the vector $\rho^\top = [\rho_1^\top, \dots, \rho_{N_\nu}^\top]^\top$ with ρ solution to

$$\rho = (I_{nN_\nu} - \mathbf{A}_\nu)^{-1} \mathbf{B}_\nu, \quad (4.4)$$

where $\mathbf{B}_\nu^\top = [b_{\nu(N_\nu)}^\top, b_{\nu(1)}^\top, \dots, b_{\nu(N_\nu-1)}^\top]^\top$. As a reminder, equation (4.4) results from the reformulation of the system of equations

$$\rho_{[i+1]_\nu} = A_{\nu(i)} \rho_i + b_{\nu(i)}, \quad \forall i \in \mathfrak{D}_\nu, \quad (4.5)$$

□

LMI condition (4.2) is already known in the literature on discrete periodic linear sys-

tems, yet the next sections offer new interpretations in the context of stabilization of switched affine systems (see [36] and the next section).

4.2.2 Periodic switching control law

The first switching rule to be presented is a periodic time-triggered switching law, which was introduced in [36]. As a matter of fact, the following statement is very close to Proposition 4.1 because having a Schur stable monodromy matrix does not only imply the existence of a limit cycle but also assesses its stability. This can be stated as follows.

Theorem 4.1: Stabilizing periodic control law

For a given cycle $\nu \in \mathfrak{C}$, if there exists matrices $\{P_i\}_{i \in \mathfrak{D}_\nu}$ in \mathbb{S}^n solution to (4.2), then the following statements hold:

- (i) There exists a unique limit cycle $k \mapsto (\nu(k), \rho_{\lfloor k \rfloor_\nu})$ for system (4.1) where $\{\rho_i\}_{i \in \mathfrak{D}_\nu}$ are determined by (4.4).
- (ii) The periodic switching control law

$$u(k) = \left\{ \nu(k - \delta) \right\}, \quad \sigma(k) = \nu(k - \delta), \quad \delta \in \mathfrak{D}_\nu, \quad \forall k \in \mathbb{N} \quad (4.6)$$

globally asymptotically stabilizes system (4.1) to this limit cycle.

Proof. The proof of item (i) is as in Proposition 4.1.

Proof of (ii): Note that the asymptotic stabilization to the hybrid limit cycle is ensured if

$$\lim_{k \rightarrow +\infty} \begin{pmatrix} \sigma(k) \\ x(k) \end{pmatrix} - \begin{pmatrix} \nu(k - \delta) \\ \rho_{\lfloor k - \delta \rfloor_\nu} \end{pmatrix} = 0.$$

The first row obviously equals to 0 by applying the control law (4.6) so the proof is reduced to showing that the state $x(k)$ tends to $\rho_{\lfloor k - \delta \rfloor_\nu}$ as k tends to infinity. Let us consider the time-dependent candidate Lyapunov function V_{td} given by

$$V_{td}(x(k), k) := \left(x(k) - \rho_{\lfloor k - \delta \rfloor_\nu} \right)^\top P_{\nu(k - \delta)} \left(x(k) - \rho_{\lfloor k - \delta \rfloor_\nu} \right), \quad \forall x(k) \in \mathbb{R}^n. \quad (4.7)$$

When computing the forward increment $\Delta V_{td}(x(k), k) = V_{td}(x(k + 1), k + 1) - V_{td}(x(k), k)$, we can manipulate the term $x(k + 1)$ so

$$x(k + 1) = A_{\nu(k - \delta)} x(k) + b_{\nu(k - \delta)} = A_{\nu(k - \delta)} \left(x(k) - \rho_{\lfloor k - \delta \rfloor_\nu} \right) + \underbrace{A_{\nu(k - \delta)} \rho_{\lfloor k - \delta \rfloor_\nu} + b_{\nu(k - \delta)}}_{= \rho_{\lfloor k + 1 - \delta \rfloor_\nu}}. \quad (4.8)$$

This last equation refers to the fact that the ρ_i 's are the elements of the state limit cycle and verify (4.4). This yields to

$$\Delta V_{td}(x(k), k) = \left(x(k) - \rho_{\lfloor k - \delta \rfloor_\nu} \right)^\top \left(A_{\nu(k - \delta)}^\top P_{\nu(k + 1 - \delta)} A_{\nu(k - \delta)} - P_{\nu(k - \delta)} \right) \left(x(k) - \rho_{\lfloor k - \delta \rfloor_\nu} \right) < 0.$$

Hence, it can be concluded that

$$\lim_{k \rightarrow +\infty} \|x(k) - \rho_{\lfloor k-\delta \rfloor_\nu}\| = 0$$

due to the fact that the Lyapunov function V_{td} is strictly decreasing all along the trajectories of the system. The proof holds true for any $\delta \in \mathfrak{D}_\nu$. \square

Remark 4. Let us define the attractor

$$\mathcal{A}_\nu := \bigcup_{i \in \mathfrak{D}_\nu} \{ \rho_i \} \quad (4.9)$$

where the vectors ρ_i , $i \in \mathfrak{D}_\nu$ are solutions to (4.4) for a given cycle $\nu \in \mathfrak{C}$. The convergence of the state trajectories to the set \mathcal{A}_ν is ensured if we have

$$\lim_{k \rightarrow +\infty} d_{\mathcal{A}_\nu}(x(k)) := \lim_{k \rightarrow +\infty} \left(\min_{i \in \mathfrak{D}_\nu} \|x(k) - \rho_i\| \right) = 0. \quad (4.10)$$

Hence, the convergence of the hybrid trajectory $s(k) = (\sigma(k), x(k))$ to the limit cycle composed of the couple (ν, ρ) necessarily implies the convergence to the attractor \mathcal{A}_ν ; the converse is not true.

4.2.3 Min-switching control law

The time-dependency of the previous control law can be seen as a drawback since it is an open-loop control law. The convergence rate of the system trajectories to the limit cycle is characterized by the eigenvalues of the monodromy matrix $\Phi_{\nu(0)}$. This performance can however be improved by considering a min-switching state-dependent control. Let us present then the state-feedback min-switching control law in the following theorem.

Theorem 4.2

For a given cycle ν in \mathfrak{C} , if there exists matrices $\{P_i\}_{i \in \mathfrak{D}_\nu}$ in \mathbb{S}^n solution to (4.2), then the following statements hold:

- (i) There exists a unique limit cycle $k \mapsto (\nu(k), \rho_{\lfloor k \rfloor_\nu})$ for system (4.1) where $\{\rho_i\}_{i \in \mathfrak{D}_\nu}$ are determined by (4.4).

Also, with the switching control law ^a

$$u(x) = \left\{ \nu(\theta), \theta \in \arg \min_{i \in \mathfrak{D}_\nu} (x - \rho_i)^\top P_i (x - \rho_i) \right\} \subseteq \mathbb{K}, \quad (4.11)$$

- (ii) Attractor $\mathcal{A}_\nu = \bigcup_{i \in \mathfrak{D}_\nu} \{ \rho_i \}$ is globally exponentially stable for system (4.1).
- (iii) Moreover, under the additional condition that if equation $\rho_i = \rho_j$ holds for any i, j in \mathfrak{D}_ν , it implies that $i = j$, then there exists $k_0 \in \mathbb{N}$ and an integer $\delta \in \mathfrak{D}_\nu$ such that for any solutions $x(k)$, $k \in \mathbb{N}$ to the closed-loop system, it holds

$$u(x(k)) = \left\{ \nu(k - \delta) \right\}, \quad \forall k \geq k_0, \quad (4.12)$$

and consequently

$$\lim_{k \rightarrow +\infty} \|x(k) - \rho_{\lfloor k-\delta \rfloor_\nu}\| = 0.$$

^a θ denotes the set of indexes $i \in \mathfrak{D}_\nu$ that minimize the quadratic function $(x - \rho_i)^\top P_i (x - \rho_i)$

Proof. The proof of item (i) is as in Proposition 4.1. For the remaining points, let us consider the following candidate Lyapunov function

$$V(x(k)) = \min_{i \in \mathfrak{D}_\nu} (x(k) - \rho_i)^\top P_i (x(k) - \rho_i), \quad \forall x(k) \in \mathbb{R}^n. \quad (4.13)$$

Proof of (ii): Let us first note that there is a limited number of matrices P_i , which are all assumed to be positive definite. Hence, the inequality

$$0 \leq c_1 d_{\mathcal{A}_\nu}^2(x(k)) \leq V(x(k)) \leq c_2 d_{\mathcal{A}_\nu}^2(x(k)), \quad (4.14)$$

follows with $c_1 = \min_{i \in \mathfrak{D}_\nu} \lambda_m(P_i) > 0$ and $c_2 = \max_{i \in \mathfrak{D}_\nu} \lambda_M(P_i) > 0$ and where $d_{\mathcal{A}_\nu}(x(k))$, given in (4.10), defines the distance of a vector $x(k)$ in \mathbb{R}^n to the attractor \mathcal{A}_ν over \mathbb{R}^n . The computation of the forward increment of the Lyapunov function along the trajectories of the system yields

$$\Delta V(x(k)) := \min_{j \in \mathfrak{D}_\nu} (x(k+1) - \rho_j)^\top P_j (x(k+1) - \rho_j) - \min_{i \in \mathfrak{D}_\nu} (x(k) - \rho_i)^\top P_i (x(k) - \rho_i)$$

$$\Delta V(x(k)) = \min_{j \in \mathfrak{D}_\nu} (x(k+1) - \rho_j)^\top P_j (x(k+1) - \rho_j) - (x(k) - \rho_\theta)^\top P_\theta (x(k) - \rho_\theta).$$

The last expression has been obtained by noting that θ results from the control law in (4.11), and is such that it minimizes the quadratic term, by definition. The first term of ΔV , being the minimum of several values, is consequently less than or equal to any of them. In particular, this is also true by selecting the term associated to $\lfloor \theta + 1 \rfloor_\nu$, yielding

$$\Delta V(x(k)) \leq (x(k+1) - \rho_{\lfloor \theta+1 \rfloor_\nu})^\top P_{\lfloor \theta+1 \rfloor_\nu} (x(k+1) - \rho_{\lfloor \theta+1 \rfloor_\nu}) - (x(k) - \rho_\theta)^\top P_\theta (x(k) - \rho_\theta).$$

From the dynamics of the closed-loop switched affine system (4.1),(4.11), with the state limit cycle given by (4.5), one has

$$\begin{aligned} x(k+1) - \rho_{\lfloor \theta+1 \rfloor_\nu} &= A_{\nu(\theta)} x(k) + b_{\nu(\theta)} - \rho_{\lfloor \theta+1 \rfloor_\nu} \\ &= A_{\nu(\theta)} (x(k) - \rho_\theta) + \underbrace{A_{\nu(\theta)} \rho_\theta + b_{\nu(\theta)} - \rho_{\lfloor \theta+1 \rfloor_\nu}}_{=0}. \end{aligned} \quad (4.15)$$

Re-injecting this expression into the upper bound of $\Delta V(x(k))$ leads to the following inequality

$$\Delta V(x(k)) \leq (x(k) - \rho_\theta)^\top (A_{\nu(\theta)}^\top P_{\lfloor \theta+1 \rfloor_\nu} A_{\nu(\theta)} - P_\theta) (x(k) - \rho_\theta).$$

Therefore, if matrices P_i 's verify the strict inequalities in (4.2), there exists a small enough positive scalar $c_3 > 0$, such that $A_{\nu(i)}^\top P_{\lfloor i+1 \rfloor_\nu} A_{\nu(i)} - P_i \prec -c_3 I_n$, for all $i \in \mathfrak{D}_\nu$, yielding

$$\Delta V(x(k)) \leq -c_3 \|x(k) - \rho_\theta\|^2 \leq -c_3 d_{\mathcal{A}_\nu}^2(x(k)) \leq -\frac{c_3}{c_2} V(x(k)), \quad \forall x(k) \in \mathbb{R}^n,$$

due to $\|x(k) - \rho_\theta\| \geq d_{\mathcal{A}_\nu}(x(k))$ and inequality (4.14). $V(x(k))$ is a control Lyapunov function for closed-loop system (4.1),(4.11). The map $k \rightarrow V(x(k))$ converges globally exponentially to zero. This proves the global exponential convergence of the closed-loop trajectory to attractor \mathcal{A}_ν .

Proof of (iii): The idea is then to prove that there exist $k_0 \in \mathbb{N}$ and $\delta \in \mathbb{K}$ such that

$$u(x(k)) = \left\{ \nu(k - \delta) \right\}, \quad \sigma(k) = \nu(k - \delta), \quad \forall k \geq k_0. \quad (4.16)$$

The proof is obtained by showing that there exists a sufficiently small scalar $\epsilon > 0$ (to be determined in this proof), such that we have the implication:

$$\left\{ \begin{array}{l} x(k) \in \mathcal{S}_\epsilon := \{ x(k) \in \mathbb{R}^n, V(x(k)) \leq \epsilon^2 \} \\ \theta \in \underset{i \in \mathfrak{D}_\nu}{\operatorname{argmin}} \left(x(k) - \rho_i \right)^\top P_i \left(x(k) - \rho_i \right) \end{array} \right.$$

imply

$$\left(x(k) - \rho_{\lfloor \theta+1 \rfloor_\nu} \right)^\top P_{\lfloor \theta+1 \rfloor_\nu} \left(x(k) - \rho_{\lfloor \theta+1 \rfloor_\nu} \right) < \left(x(k) - \rho_j \right)^\top P_j \left(x(k) - \rho_j \right), \quad (4.17)$$

for all $j \in \mathfrak{D}_\nu$, with $j \neq \lfloor \theta+1 \rfloor_\nu$, that is the solution of the next optimization problem (4.11) is $\lfloor \theta+1 \rfloor_\nu$. To sum up, k_0 is related to the time to reach the level set \mathcal{S}_ϵ , which is always possible to reach thanks to the convergence of the Lyapunov function to zero. The shift δ is determined thanks to the solution θ of the optimization problem at time k_0 , that is on the initial condition x_0 and the selection of the previous switching modes. First, notice that thanks to the equivalence of weighted norms, there exist constants $c_{i,j} > 0$, $\forall (i, j) \in \mathfrak{D}_\nu$, such that

$$\|x(k)\|_{P_i} \leq c_{i,j} \|x(k)\|_{P_j}, \quad (4.18)$$

(for instance, select $c_{i,j} \geq \sqrt{\lambda_M(P_i)/\lambda_m(P_j)}$). Thanks to LMIs (4.2) and $x \in \mathcal{S}_\epsilon$, we have, with the notation $x(k+1) = A_{\nu(\theta)}x(k) + B_{\nu(\theta)}$,

$$\|x(k+1) - \rho_{\lfloor \theta+1 \rfloor_\nu}\|_{P_{\lfloor \theta+1 \rfloor_\nu}} \leq \|x(k) - \rho_\theta\|_{P_\theta} \leq \epsilon. \quad (4.19)$$

Thanks to (4.15) and having x in \mathcal{S}_ϵ , the inequalities

$$\begin{aligned} \|x(k+1) - \rho_{\lfloor \theta+1 \rfloor_\nu}\|_{P_\theta} &= \|A_{\nu(\theta)}(x(k) - \rho_\theta)\|_{P_\theta} \leq \|A_{\nu(\theta)}\|_{P_\theta} \|x(k) - \rho_\theta\|_{P_\theta}, \\ &\leq \|A_{\nu(\theta)}\|_{P_\theta} \epsilon \end{aligned} \quad (4.20)$$

hold, where $\|A_{\nu(\theta)}\|_{P_\theta}$ denotes the matrix norm induced by the weighted norm $\|\cdot\|_{P_\theta}$. That yields, due to the triangular inequality and relations (4.18),

$$\begin{aligned} \left\| \rho_{\lfloor \theta+1 \rfloor_\nu} - \rho_j \right\|_{P_\theta} - \left\| A_{\nu(\theta)} \right\|_{P_\theta} \epsilon &\leq \left\| \rho_{\lfloor \theta+1 \rfloor_\nu} - \rho_j \right\|_{P_\theta} - \left\| A_{\nu(\theta)} (x(k) - \rho_\theta) \right\|_{P_\theta}, \\ &\leq \left\| \rho_{\lfloor \theta+1 \rfloor_\nu} - \rho_j + A_{\nu(\theta)} (x(k) - \rho_\theta) \right\|_{P_\theta}, \\ &\leq \left\| x(k+1) - \rho_j \right\|_{P_\theta}, \\ &\leq c_{\theta,j} \left\| x(k+1) - \rho_j \right\|_{P_j}, \quad \forall j \in \mathfrak{D}_\nu. \end{aligned} \quad (4.21)$$

Since having $\rho_i = \rho_j$ for any i, j in \mathfrak{D}_ν implies that $i = j$, it is always possible to find a positive scalar ϵ such that the strict inequalities $0 < c_{\theta,j} \epsilon < \left\| \rho_{\lfloor \theta+1 \rfloor_\nu} - \rho_j \right\|_{P_\theta} - \left\| A_{\nu(\theta)} \right\|_{P_\theta} \epsilon$ hold for any $j \in \mathfrak{D}_\nu$, $j \neq \lfloor \theta+1 \rfloor_\nu$. Combining the two latter inequalities leads to

$$\epsilon < \left\| x(k+1) - \rho_j \right\|_{P_j}, \quad \forall j \in \mathfrak{D}_\nu \setminus \{\lfloor \theta+1 \rfloor_\nu\}. \quad (4.22)$$

Comparing inequalities (4.19) and (4.22) concludes

$$\left\| x(k+1) - \rho_{\lfloor \theta+1 \rfloor_\nu} \right\|_{P_{\lfloor \theta+1 \rfloor_\nu}} \leq \epsilon < \left\| x(k+1) - \rho_j \right\|_{P_j}, \quad \forall j \in \mathfrak{D}_\nu \setminus \{\lfloor \theta+1 \rfloor_\nu\},$$

which ends the proof of the convergence of the switching signal in finite time. The last statements holds true according to Corollary 4.1. \square

In the next section, Theorem 4.2 and results in Section 3.3.2 are commented and several of important consequences are emphasized. More particularly, the properties of the feasibility of conditions (4.2), the nature of the Lyapunov function (4.13) are investigated.

4.3 Discussions regarding the main result

4.3.1 Feasibility of the sufficient conditions

Theorem 4.2 is based on the feasibility of the LMIs (4.2). Such inequalities have been already encountered in the framework of discrete-time linear periodic systems. By the periodic Lyapunov lemma (see [11]), we have the following result:

Lemma 4.1: In [15, Section 2]

For a given cycle ν , there exist positive definite matrices $\{P_i\}_{i \in \mathfrak{D}_\nu}$ satisfying LMIs (4.2) if and only if the monodromy matrix $\Phi_{\nu(0)}$ is Schur stable.

One of the main advantage of Lemma 4.1 is that the condition dealing with the monodromy matrix can be moved closer to the Lemmas 3.1 and 3.2 conditions. For a given cycle $\nu \in \mathfrak{C}$, having a Schur monodromy matrix $\Phi_{\nu(0)}$ implies that there exists a unique limit cycle thanks to Lemma 3.2 – this is stated in Proposition 4.1. Having $\Phi_{\nu(0)}$ Schur stable also implies that there exist stabilizing switching rules for system (4.1) – see Theorem 4.1 and Theorem 4.2. The importance of having Schur monodromy

matrices being revealed, the question is now to understand whether there exists, for a given system (4.1), a cycle $\nu \in \mathfrak{C}$ associated with a stable monodromy matrix. The literature about the (periodic)-stabilizability of switched linear system provides useful conditions as for instance, the following lemma, which provides sufficient conditions based on discrete-time Lyapunov-Metzler inequalities (see [48]):

Lemma 4.2: In [43, Theorems 6 and 22]

If there exist K symmetric positive definite matrices $\{\tilde{P}_i\}_{i \in \mathbb{K}}$ and a matrix $\pi \in \mathbb{R}^{K \times K}$ such that $\pi_{j,i} \geq 0$, $\forall (i, j) \in \mathbb{K}^2$, $\sum_{j \in \mathbb{K}} \pi_{j,i} = 1$, $\forall i \in \mathbb{K}$ and $A_i^\top \left(\sum_{j \in \mathbb{K}} \pi_{j,i} P_j \right) A_i - P_i < 0_n$, for all $i \in \mathbb{K}$, then there exists a cycle $\nu \in \mathfrak{C}$ such that the monodromy matrix $\Phi_{\nu(0)}$ is Schur.

Moreover we have the following equivalence, that allows to guarantee the existence of a stable limit cycle:

Lemma 4.3: In [43, Theorem 22]

There exist $N \in \mathbb{N}$, and a cycle $\nu \in \mathfrak{C}_N$ such that $\Phi_{\nu(0)}$ is Schur if and only if there exist $M \in \mathbb{N}$, and scalars $\pi_\nu \geq 0$, for any $\nu \in \tilde{\mathfrak{C}}_M = \cup_{j=1, \dots, M} \mathfrak{C}_j$, such that $\sum_{\nu \in \tilde{\mathfrak{C}}_M} \pi_\nu = 1$ and $\sum_{\nu \in \tilde{\mathfrak{C}}_M} \pi_\nu \Phi_{\nu(0)}^\top \Phi_{\nu(0)} < I_n$.

Here, we are interesting in periodic-stabilizable linear switched systems. It should be recalled that stabilizable linear switched systems is not necessarily periodic-stabilizable, as shown in [43, Proposition 21 and Counter-example 17]. In other words, the LMI of Theorem 4.2 are not necessary for the stabilization of switched affine systems.

4.3.2 Structure of the Lyapunov function

The (control)-Lyapunov function $V : \mathbb{R}^n \mapsto \mathbb{R}^+$, $x \rightarrow V(x)$ defined by (4.13), is build only on the knowledge of the couples $\{\rho_i, P_i\}_{i \in \mathfrak{D}_\nu}$ and does not depend on their order, that is roughly speaking on the cycle ν . This characteristic differs from the periodic Lyapunov function considered in [36], $\tilde{V} : (x, k) \in \mathbb{R}^n \times \mathbb{N} \rightarrow \tilde{V}(x, [k]_\nu) \in \mathbb{R}^+$, where $[k]_\nu$ can be interpreted as a counter/index in the period of ν . One major benefit of this time-independency is that the min-switching argument in (4.11) is a pure state-feedback. In practice, this state-feedback is designed by a state-space partition, which is *a priori* given and only dependent on the couples $\{\rho_i, P_i\}_{i \in \mathfrak{D}_\nu}$. The associated state-space partition is bounded by arcs of the solutions of

$$(x - \rho_i)^\top P_i (x - \rho_i) - (x - \rho_j)^\top P_j (x - \rho_j) = 0, \quad (i, j) \in \mathfrak{D}_\nu^2, i \neq j,$$

or,

$$x^\top (P_i - P_j) x - 2(\rho_i^\top P_i - \rho_j^\top P_j) x + \rho_i^\top P_i \rho_i - \rho_j^\top P_j \rho_j = 0, \quad (i, j) \in \mathfrak{D}_\nu^2, i \neq j.$$

Geometrically these curves are conic ones and the matrix representation of the previous equation can be written as

$$\begin{bmatrix} x \\ 1 \end{bmatrix}^\top \underbrace{\begin{bmatrix} P_i - P_j & \rho_i^\top P_i - \rho_j^\top P_j \\ * & \rho_i^\top P_i \rho_i - \rho_j^\top P_j \rho_j \end{bmatrix}}_{\mathcal{Q}} \begin{bmatrix} x \\ 1 \end{bmatrix} = 0.$$

Therefore, if the determinant of matrix \mathcal{Q} is non-zero, the conic is for instance: a line if $P_i = P_j$, an ellipsoid if $P_i - P_j$ is positive-definite or an hyperboloid if $P_i - P_j$ is negative-definite. Finally, the Lyapunov function being defined as the minimum of a set of shifted quadratic forms, its level sets are the union of given ellipsoids (with weighted matrix P_i) centered in ρ_i .

4.3.3 Comparison with [36]

This section aims at comparing Theorem 4.2 with respect to [36, Theorem 2]. While the LMI conditions are exactly the same for a given cycle ν , the contributions are different. Indeed, the control law given in [36, Theorem 2] is

$$u(x(k), \nu(k), k) = \underset{j \in \mathbb{K}}{\operatorname{argmin}} \begin{bmatrix} x(k) - \rho_{[k]_\nu} \\ 1 \end{bmatrix}^\top \mathcal{L}_{k,j} \begin{bmatrix} x(k) - \rho_{[k]_\nu} \\ 1 \end{bmatrix} \subset \mathbb{K}, \quad (4.23)$$

where

$$\mathcal{L}_{i,j} = \begin{bmatrix} A_j^\top P_{[i+1]_\nu} A_j - P_i & A_j^\top P_{[i+1]_\nu} B_{i,j} \\ * & B_{i,j}^\top P_{[i+1]_\nu} B_{i,j} \end{bmatrix}$$

with $B_{i,j} = A_j \rho_i + b_j - \rho_{[i+1]_\nu}$. Moreover, the Lyapunov function used in [36] is

$$V(x(k), \nu(k), k) = \left(x(k) - \rho_{[k]_\nu} \right)^\top P_{[k]_\nu} \left(x(k) - \rho_{[k]_\nu} \right), \quad \forall x(k) \in \mathbb{R}^n. \quad (4.24)$$

The authors in [36] provide sufficient conditions to the stabilization to the state trajectory (but not to the hybrid trajectory including the switching law), if (4.2) are satisfied. Note that this control law depends on a time counter $\nu(k)$ such that at each instant time k , the control input selects the point in the cycle ν from an *argmin* function that goes down the K -functioning modes.

Based on the same LMI conditions, the second statement in Theorem 4.2 concerns the convergence to the attractor, while [36, Theorem 2] provides the convergence to the state limit cycle. Referring to Remark 4, the latter implies the convergence to the attractor too. However if the assumption stated in Theorem 4.2 holds, that is the state limit cycle does not cross itself, our third result in Theorem 4.2 provides a periodic solution for the hybrid trajectory with the switching law converging to $\nu(k - \delta)$. Notice that this is not the case for [36, Theorem 2], even if the assumption holds (see Example in Section 4.5.2). This value of shift, δ , depends on the initial state x_0 and possibly

on the choice of the switching law in the inclusion (4.11). Notice also that, for $k \geq k_0$, the set $u(x(k))$ reduces to a singleton and there is a unique selection of the mode to activate. A similar result may be obtained in [36, Theorem 2], when a unique mode allows to steer a ρ_i to its successor in the state trajectory, that is there exists a unique j_0 such that $b_{i,j_0} = 0$. Item (iii) of Theorem 4.2 emphasizes that even if the Lyapunov function does not depend on the cycle ν , the min-switching strategy recovers a shifted version of ν , as an element of hybrid trajectory to the equivalent relation of attractors. It is worth noting that, for a given cycle ν , our proposed control law (4.11) aims at selecting the best mode that minimizes the quadratic term in V , looking for the best position in the cycle. Alternatively, control law (4.23) selects the mode that minimizes $\Delta V(x, \nu, k)$ derived from (4.24). Hence, the computational complexity of both control laws are different, depending on the length of the cycle and on the number of modes. For instance, depending on whether $N_\nu > K$ or $N_\nu < K$, control (4.11) or control (4.23) can reduce the computational cost and reduces the transient time, respectively. To sum up, the two contributions are different and their use depends on the context. It is hard to decide whether one is better than the other.

An important property of the min-switching algorithm (4.11) is that this control law does not depend on the system parameters different to (4.23), enabling to develop a robust control law that takes into account parametric uncertainties. Hence, the next chapter is devoted to present a robust control law that ensures the states to converge to a *robust limit cycle*, i.e., an invariant set of shifted ellipsoids associated to a cycle ν .

4.4 Optimization

Until now, the only objective in the design of the switching rule was to reduce considerably the size of the set where the state trajectories of the system converge to. Even more, in the process, we had set aside not only the asymptotic stabilization to an operating point but also any connection to this point since Proposition 2.1. Indeed, it has been shown that the centers of the ellipsoids composing the attractors in Chapter 2 are independent of any coordinate translations; the state limit cycles also (see Proposition 3.1 in Chapter 3). The objective of this section is then to include to the previous developments some additional constraints aiming at selecting the state limit cycle that optimizes a given cost function. This cost function has to be defined for each cycle and will not depend on the switching law. In addition, in practical situations and in particular in the context of power converters, the objective is to drive the solutions to the system as close as possible to a desired reference position, $x_d \in \mathbb{R}^n$.

Following the previous developments, a possible way to formalize the notion of a cost related to a “distance” and/or a “size”, can be formulated as follows

$$J^*(\nu, x_d) := \min_{\{\rho_i\}_{i \in \mathfrak{D}_\nu}} \gamma J_1(\nu, x_d, \{\rho_i\}_{i \in \mathfrak{D}_\nu}) + (1 - \gamma) J_2(\nu, \{\rho_i\}_{i \in \mathfrak{D}_\nu}) \quad (4.25)$$

s.t. (4.2) and potential additional inequalities,

where J^* is the optimal cost function based on J_1 and J_2 that depend on the state limit cycle. They are given by

Cycles $\nu_i \in \mathfrak{C}$	Associated state limit cycles						$J^*(\nu_i, 0)$					
$\nu_1 = \{1, 2\}$			$\begin{bmatrix} 1.66 \\ -0.2 \\ -0.04 \end{bmatrix}$,	$\begin{bmatrix} 2.24 \\ -0.81 \\ -1.01 \end{bmatrix}$		2.57					
$\nu_2 = \{1, 2, 2, 2\}$		$\begin{bmatrix} 3.2 \\ 0.99 \\ -0.3 \end{bmatrix}$,	$\begin{bmatrix} 4.49 \\ -0.81 \\ -2.8 \end{bmatrix}$,	$\begin{bmatrix} 3.3 \\ -1.15 \\ -0.26 \end{bmatrix}$,	$\begin{bmatrix} 2.67 \\ -0.03 \\ 0.24 \end{bmatrix}$	7.85			
$\nu_3 = \{1, 1, 1, 1, 2, 2\}$	$\begin{bmatrix} -0.65 \\ 1.06 \\ 0.08 \end{bmatrix}$,	$\begin{bmatrix} 1.32 \\ 0.71 \\ -0.89 \end{bmatrix}$,	$\begin{bmatrix} 2.42 \\ -0.64 \\ -1.63 \end{bmatrix}$,	$\begin{bmatrix} 2 \\ -2.1 \\ -1.08 \end{bmatrix}$,	$\begin{bmatrix} 0.59 \\ -2.48 \\ 0.39 \end{bmatrix}$,	$\begin{bmatrix} -0.98 \\ -0.55 \\ 1.03 \end{bmatrix}$	3.08

Table 4.1: On the first column are the different cycles considered (Example 1). Each cycle generates a unique state limit cycle displayed in the column on the center. The last column depicts the optimal cost function (4.25) with $\gamma = 0.5$ and $x_d = [0 \ 0 \ 0]^\top$.

- $J_1(\nu, x_d, \{\rho_i\}_{i \in \mathfrak{D}_\nu}) = \omega_1$ with either

$$\omega_1 = \left(x_d - \frac{1}{N_\nu} \sum_{i \in \mathfrak{D}_\nu} \rho_i \right)^\top \Gamma \left(x_d - \frac{1}{N_\nu} \sum_{i \in \mathfrak{D}_\nu} \rho_i \right)$$

which is the distance between the average value of the state limit cycle and the desired reference, or

$$\omega_1 = \frac{1}{N_\nu} \sum_{i \in \mathfrak{D}_\nu} (x_d - \rho_i)^\top \Gamma (x_d - \rho_i)$$

where Γ is a projection matrix (see for instance [36]), depending on an adequate notion of distance to a desired position denoted as $x_d \in \mathbb{R}^n$. Here, J_1 will allow to select a limit cycle closed in a certain sense to a desired position that is predefined by the designer.

- $J_2(\nu, \{\rho_i\}_{i \in \mathfrak{D}_\nu}) = \omega_2$ with

$$\omega_2 = \frac{1}{2N_\nu} \sum_{i \in \mathfrak{D}_\nu} \left(\frac{1}{N_\nu - 1} \sum_{j \in \mathfrak{D}_\nu} (\rho_i - \rho_j)^\top (\rho_i - \rho_j) \right).$$

Cost J_2 takes into account the distance within the state limit cycle. A lower cost will show a vector ρ with its components close to each other.

It is worth noting that this optimization process is performed offline and is independent to the solution to the LMI constraint (4.2).

4.5 Examples

4.5.1 Example 1

Consider the discrete-time system (4.1), borrowed from [33], where the matrices A_i and B_i are defined as follows

$$A_i = e^{F_i T}, \quad b_i = \int_0^T e^{F_i \tau} d\tau g_i, \quad \forall i \in \{1, 2\}, \quad (4.26)$$

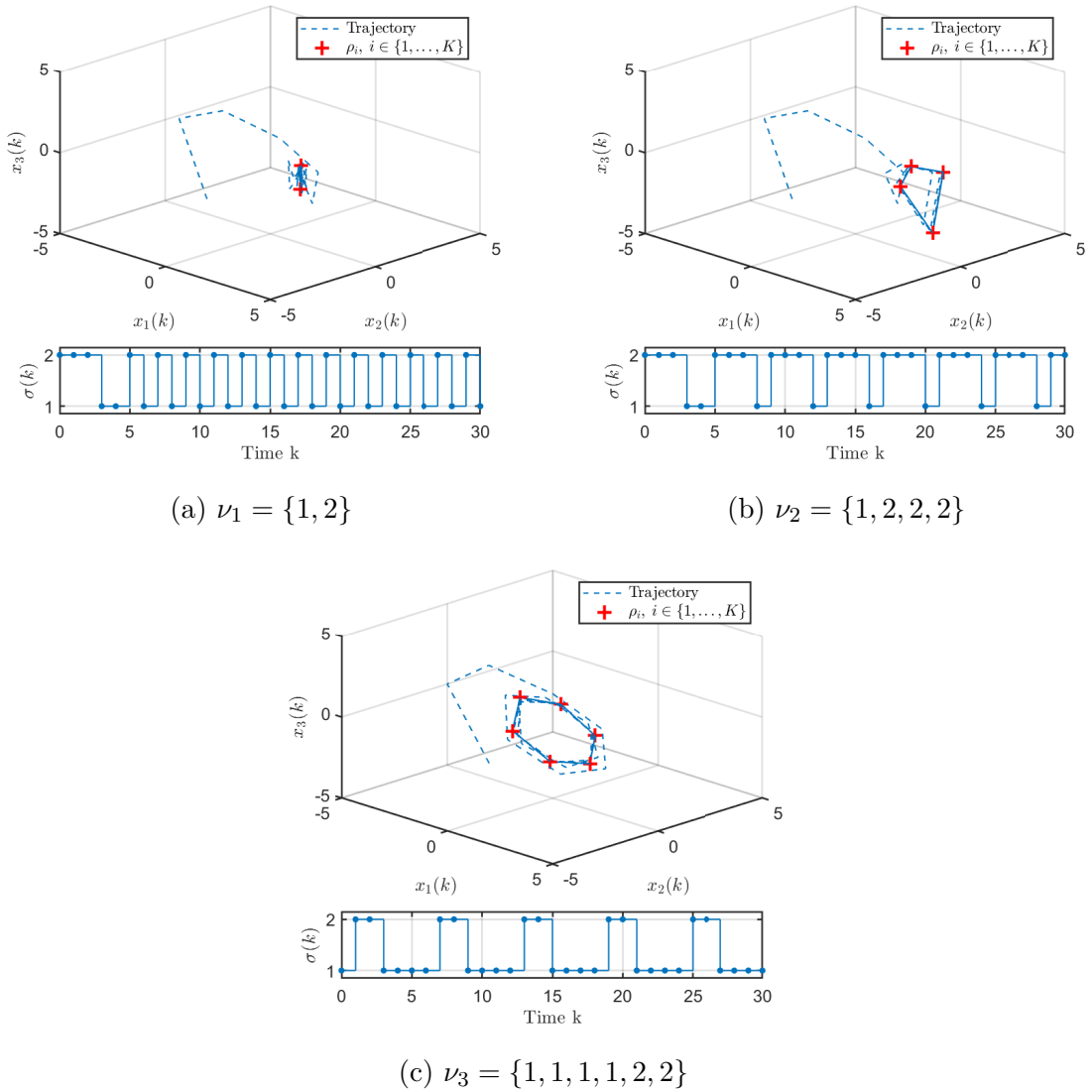

Figure 4.1: Evolution of the state variables (blue dotted line) for three different cycles ν_1 , ν_2 and ν_3 with their associated limit cycles (red crosses). The figures at the bottom show the switching control law in each case. (Example 1)

where $T = 1$ refers to the sampling period. Matrices F_i and g_i for $i = 1, 2$ are given by

$$F_1 = \begin{bmatrix} 0 & 1 & 0 \\ 0 & 0 & 1 \\ -1 & -1 & -1 \end{bmatrix}, \quad F_2 = \begin{bmatrix} 0 & 1 & 0 \\ 0 & 0 & 1 \\ 0 & -1 & -1 \end{bmatrix}, \quad g_1 = \begin{bmatrix} 1 \\ 0 \\ 0 \end{bmatrix}, \quad g_2 = \begin{bmatrix} 0 \\ 1 \\ 0 \end{bmatrix}.$$

It is worth noting that, for this example, there exists a linear combination of matrices A_i which is Schur stable as shown in [33]. At a first stage, the Figure 4.1 shows on different graphs the state limit cycles $\{\rho_i\}_{i \in \mathcal{D}_\nu}$, represented by the red crosses, obtained thanks to equation (4.4) for the different cycles $\nu_1 = \{1, 2\}$, $\nu_2 = \{1, 2, 2, 2\}$ and $\nu_3 = \{1, 1, 1, 1, 2, 2\}$. The figure also shows the trajectories of the closed-loop system,

started at the initial state $x_0 = [2, -5, 0]^\top$, with the control law presented in (4.11) in Theorem 4.2. It can be seen that each trajectory converges to different limit cycles. The control signal is represented at the bottom of each phase portrait on Figure 4.1. One can see that this switching signal tends to the presumed cycle after a small transient time as pointed out in item (ii) of Theorem 4.2.

It is worth mentioning that the results obtained here are very similar to the ones presented in [37] and [86]. However, the method provided in [86] is limited by the constraints that the length of the cycle needs to be equal to the number of mode. i.e. restricted to ν_1 . In addition, the stabilization condition of [86] have a higher complexity since the size of each LMI increases with the number of modes. Finally compared to [37], our control law does not depend on time even though it converges to a periodic signal. Table 4.1 provides a numerical point of view by gathering on the first two columns the cycles and their associated limit cycle as in Figure 4.1. In addition, as commented in Section 4.4, we can use a cost function like (4.25). We have chosen arbitrarily $\gamma = 0.5$, the cycle for which the cost function is minimized is cycle ν_1 in this case. The costs associated with the different cycles are indicated in Table 4.1.

4.5.2 Example 2

Let us illustrate the comparison made in Section 4.3.3 by an academical example. Consider the matrices A_i 's as follows

$$A_1 = \begin{bmatrix} 0.3 & 0.1 \\ 0.1 & 0.7 \end{bmatrix}, \quad A_2 = \begin{bmatrix} 0.9 & 0.5 \\ 0 & -0.8 \end{bmatrix}, \quad A_3 = \begin{bmatrix} 0.4 & 0 \\ 1 & -0.1 \end{bmatrix}, \quad A_4 = A_1 + 0.2 \begin{bmatrix} 1 & 0 \\ -1 & 0 \end{bmatrix}.$$

The affine terms are constructed with the limit cycle (ν, ρ) chosen with the cycle $\nu = \{1, 2, 3\}$ and vectors $\rho = \{[0, 1]^\top, [1, 1]^\top, [-1, 0]^\top\}$. Hence, we have

$$b_1 = b_4 = -A_1\rho_1 + \rho_2, \quad b_2 = -A_2\rho_2 + \rho_3, \quad b_3 = -A_3\rho_3 + \rho_1.$$

On Figure 4.2 is represented the state trajectory in a phase plane in addition to the state periodic sequence associated to the limit cycle (ν, ρ) . As it appears, the evolution of the state variables of system (4.1) with the switching control law (4.11) seems to have a better convergence rate. However, one must notice the differences on the switching signals. Whereas the given limit cycle should only involve three of the system functioning modes, the mode associated to the matrices A_4 and b_4 is selected periodically instead of the mode 1. Hence, this example exposes the remark made in Section 4.3.3 concerning the possible cases where at least two modes can steer one vector ρ_i to its successor.

Control (4.11) provides for this example a better result than control (4.23). Indeed, we see as system with control (4.11) converges faster to the limit cycle. One can make that extra comparison through Figure 4.3, where the evolution of the distance to the attractor is depicted.

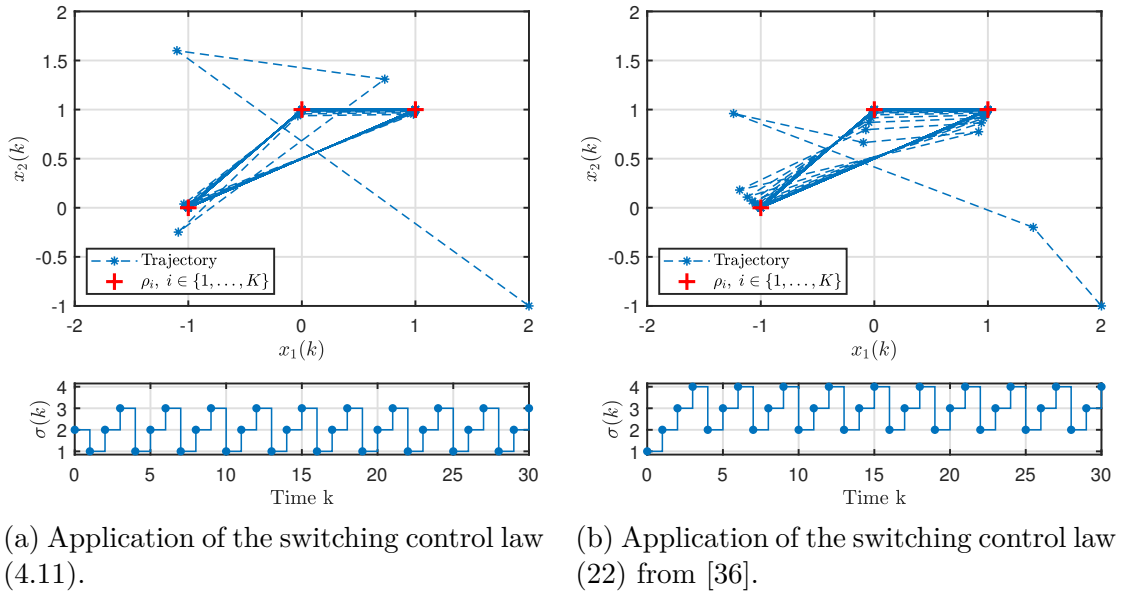

Figure 4.2: The first subfigure is an illustration of the application of Theorem 4.2; the second, the application of Theorem 2 from [36]. In each subfigure is represented the evolution of the state variables for Example 2 (blue dotted line) for a given cycle $\nu = \{1, 2, 3\}$ with their associated state vector ρ (red crosses) of the limit cycle and the figures at the bottom show the switching control law in each case.

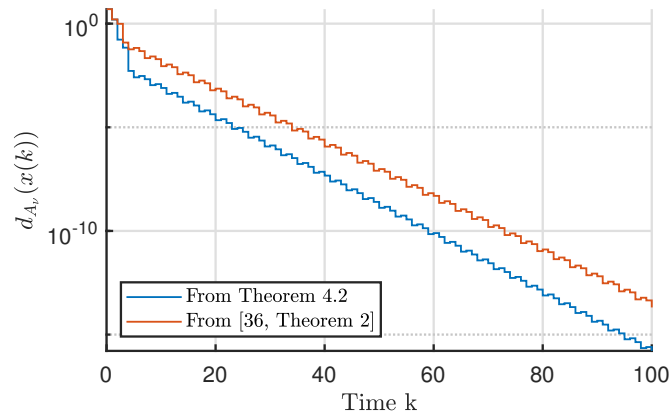

Figure 4.3: Evolution of the distance to the attractor $d_{A_\nu}(x(k))$ for Example 2 with control law (4.11) and the control law from [36, Theorem 2].

4.5.3 Example 3

Consider the discrete-time switched affine system described by the following matrices

$$A_1 = \begin{bmatrix} 1 & 0 \\ 0 & 0.5 \end{bmatrix}, \quad A_2 = 4\sqrt{2} \begin{bmatrix} \cos\left(\frac{\pi}{4}\right) & -\sin\left(\frac{\pi}{4}\right) \\ \sin\left(\frac{\pi}{4}\right) & \cos\left(\frac{\pi}{4}\right) \end{bmatrix}, \quad b_1 = \begin{bmatrix} 0.01 & 0 \end{bmatrix}^\top, \quad b_2 = \begin{bmatrix} 0 & 0 \end{bmatrix}^\top. \quad (4.27)$$

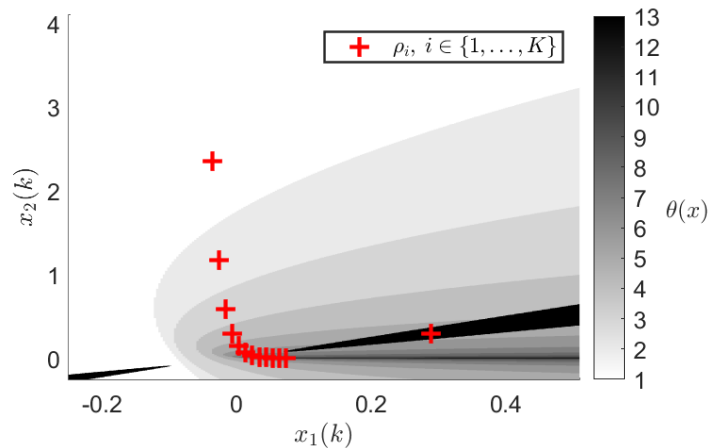

Figure 4.4: State-space partition $\theta(x)$ (Example 3).

In Chapter 2, this example has already been presented. But originally, this is the authors from [43] that introduced it. In [43], they study discrete-time switched linear systems so we had to adapt the system and to include the affine parts. However, it is still possible to comment the different results. According to [43, Lemma 30], there does not exist a linear combination of matrices A_1 and A_2 that is Schur stable, originating a fail of most of the stabilization theorem from the literature (see [33] for instance). Moreover, the authors explain in [43, Example 27] that there is no solution to the Lyapunov-Metzler inequalities which can be another speculation to the fail of the switching control design in Chapter 2. Nevertheless, we point out that the monodromy matrix with cycle $\nu = \{1^{11}, 2^2\}$ is Schur and therefore, Lemma 4.1 ensures that there exists a solution to Theorem 4.2. The switching control designs in Theorem 2.1 and Proposition 2.2 from Chapter 2 are unsuccessful but by comparing it to the present result. Propositions from Chapter 2 can be then seen as preliminary results to the limit cycle stabilization except that the switching sequence were constrained: cycle of length equal to K and composed of all the mode. In Section 4.3.2 the feature “pure state-feedback” of the min-switching argument in (4.11) is demonstrated. Then, considering the tuples $\{\rho_i, P_i\}_{i \in \mathcal{D}_\nu}$, we are able to partition the state-space, where each color on Figure 4.4 designates the areas $\theta(x)$. Figure 4.5 performs not only the evolution of the state variables converging to the limit cycle associated to ν , but also the state-space partition. Indeed, compared to Figure 4.4, the black and white areas indicate the regions of the state space where $\nu(\theta(x))$ is equal to 1 or 2. Such state space representation of the switching control law emphasizes the simplicity of the control law and appears to be very sensitive to understand.

4.6 Conclusion

Inspired by the periodic Lyapunov Lemma, a novel result has been stated in this chapter for the class of switched affine systems with discrete-time dynamics. If there exists a solution to the LMI problem, different stabilizing switching rules can be designed. The first control law, that is the periodic open-loop switching law introduced in [37]

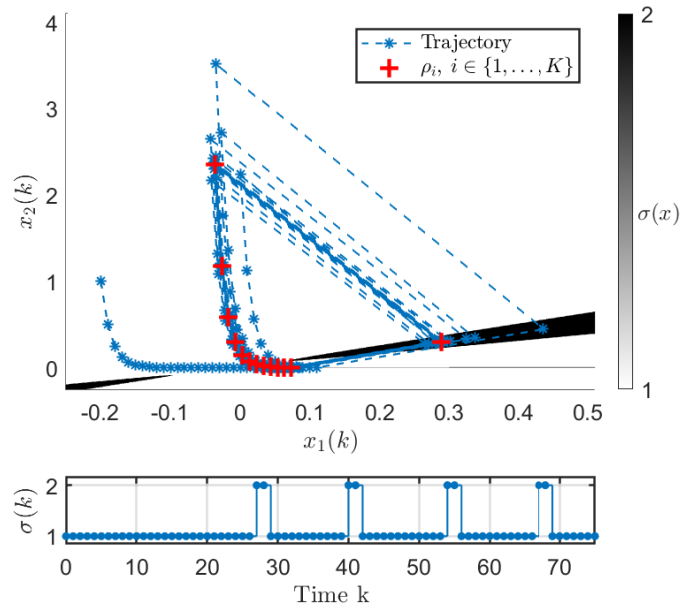

Figure 4.5: State trajectory with the state-space partition $\sigma(x) = \nu(\theta(x))$ and the switching control law (Example 3).

and resumed here in Theorem 4.1, allows us to track the reference hybrid limit cycle. However, this has for disadvantage of lacking performances in transient time, especially for long cycles.

The solution we came with to compensate this issue is a min-switching strategy that is a pure state-feedback switching control law. The system is steered to the hybrid limit cycle if there is no intersection within the state trajectory; if not, the system still converges asymptotically to a sub-trajectory.

The stabilization to limit cycle rather than a single operating point forced us to consider a novel approach for practical situations where that point is an objective to attain. Even if we can now predict the steady-state behavior contrary to practical stabilization results, some state limit cycles may be far from the reference point. Hence, in Section 4.4, we have presented some cost functions to evaluate the performances in the steady-state and to offer to some designer the possibility to measure the closeness of the limit cycle to the operating point.

Lastly, compared to the recent literature, the main benefit of Theorem 4.2 is that the switching law does not depend on the time nor on the system parameters. This leads us to the next Chapter which will deal with the case of uncertain or time-varying switched affine systems.

5

Robust stabilization to limit cycles

5.1 Motivation

Chapter 4 has presented the stabilization of discrete switched affine systems to hybrid limit cycles. Compared to the recent literature, the pure state-feedback switching control law designed in the previous chapter allows us to take into consideration systems suffering from parameter uncertainties or variations. Let us consider again the following system

$$\begin{cases} x(k+1) = A_{\sigma(k)}x(k) + b_{\sigma(k)}, & k \in \mathbb{N}, \\ \sigma(k) \in u(x(k)) \subseteq \mathbb{K}, \\ x_0 \in \mathbb{R}^n, \end{cases} \quad (5.1)$$

where $x(k) \in \mathbb{R}^n$ is the state vector, $\sigma(k) \in \mathbb{K} = \{1, 2, \dots, K\}$ characterizes the active mode and $k \in \mathbb{N}$ stands for the time variable. In (4.1), the matrices (A_i, b_i) for $i \in \mathbb{K}$ were supposed to be known, constant and of suitable dimension. From now on, matrices A_i and b_i will be assumed to be unknown and/or time-varying. To proceed to the coming design of the switching rule for such systems, it will be considered that they belong to a polytopic set given by

$$[A_i, b_i] \in \text{Co} \left([A_i^\ell, b_i^\ell] \right)_{\ell \in \mathbb{L}}, \quad \forall i \in \mathbb{K}, \quad (5.2)$$

where \mathbb{L} is a bounded subset of \mathbb{N} and where matrices A_i^ℓ and b_i^ℓ are known and constant for any $i \in \mathbb{K}$ and any $\ell \in \mathbb{L}$. Note that set \mathbb{L} may depend on mode i but this case is avoided here without lack of generality.

It is easy to see, that the results of the previous chapter fail about stabilization and stabilizability. Indeed, the main problem appears in the selection of the limit cycle of period N_ν solving equations

$$\rho_{[i+1]_\nu} = A_{\nu(i)}\rho_i + b_{\nu(i)}, \quad \forall i \in \mathfrak{D}_\nu = \{1, \dots, N_\nu\}, \quad (5.3)$$

in the situation of uncertain and/or time-varying system matrices. Therefore, it is important to investigate in this direction, and to provide an alternative solution dedicated to this relevant situation from a practical point of view. Figure 5.1 on the next page shows a simplistic illustration in a plan of that extended definition of hybrid limit cycle

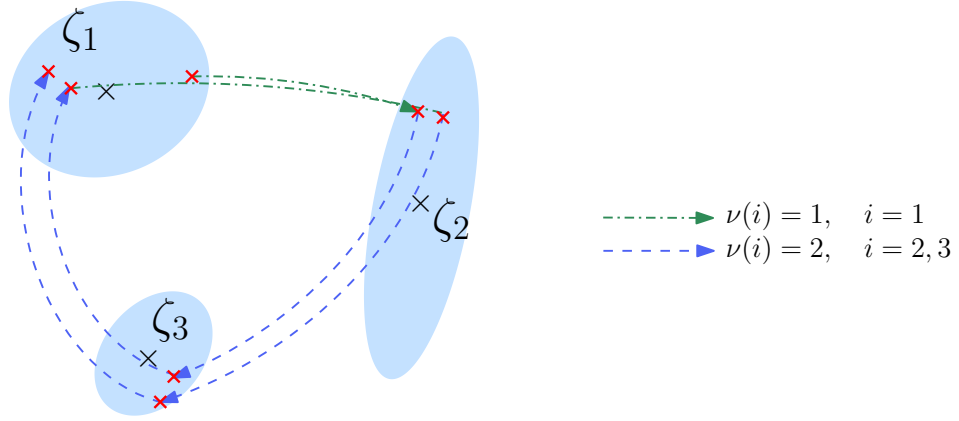

Figure 5.1: Schematic representation of a robust limit cycle associated with a cycle ν of period $N_\nu = 3$, for a system (5.1) with $K = 2$ modes.

seen in Chapter 4. This figure can be translated into the following inclusions¹

$$A_{\nu(i)}^\ell \mathcal{E}(W_i^{-1}, \zeta_i) + b_{\nu(i)}^\ell \subset \mathcal{E}(W_{[i+1]_\nu}^{-1}, \zeta_{[i+1]_\nu}), \quad \forall (i, \ell) \in \mathfrak{D}_\nu \times \mathbb{L}, \quad (5.4)$$

where the left-hand-side of the inclusion means, with a light abuse of notations, that, for any $i \in \mathfrak{D}_\nu$ and for all $x \in \mathcal{E}(W_i^{-1}, \zeta_i)$, vector $A_{\nu(i)}^\ell x + b_{\nu(i)}^\ell$ belongs to $\mathcal{E}(W_{[i+1]_\nu}^{-1}, \zeta_{[i+1]_\nu})$ for all $\ell \in \mathbb{L}$. This inclusion can be seen as the natural extension of (5.3) to uncertain systems. The set of ellipsoids $\mathcal{E}(W_i^{-1}, \zeta_i)$, $i \in \mathfrak{D}_\nu$, can be viewed as a *robust limit cycle*. The next section aims at elaborating this idea.

5.2 Design of the switching rule

A solution to this robust stabilization problem will be provided in this section, taking into account that the asymptotic convergence to the union of vectors composing the limit cycle cannot be guaranteed anymore, but an asymptotic convergence to a neighborhood of the state limit cycle; a neighborhood of each point ρ_i (points obtained in the nominal case). The vicinity of these points will be characterized as a level set of a Lyapunov function to be designed. Before providing our result, we consider the following assumption which is an equivalent to the one stated in Theorem 4.2 on page 52 adapted to the uncertain case.

Assumption 5.1: Disjoint ellipsoids

Consider matrices $W_i \in \mathbb{S}^n$ and vectors $\zeta_i \in \mathbb{R}^n$ such that the ellipsoids

$$\mathcal{E}(W_i^{-1}, \zeta_i) = \left\{ x \in \mathbb{R}^n, i \in \mathfrak{D}_\nu \mid (x - \zeta_i)^\top W_i^{-1} (x - \zeta_i) \leq 1 \right\}, \quad (5.5)$$

associated to $\nu \in \mathfrak{C}$ are disjoint.

¹Here, $\mathcal{E}(M, \eta)$ denotes an ellipsoid with a matrix $M \in \mathbb{S}_+^n$ and a vector $\eta \in \mathbb{R}^n$ (see equation (5.5) for a reminder of the definition).

Remark 5. In Chapter 4 on the stabilization of the nominal system (4.1) to limit cycles, we have defined the attractor

$$\mathcal{A}_\nu = \bigcup_{i \in \mathfrak{D}_\nu} \{\rho_i\} \quad (5.6)$$

where the vectors ρ_i are solutions of the system of equations (3.17). In a similar way, we define the attractor adapted to the uncertain case

$$\mathcal{S}_\nu := \bigcup_{i \in \mathfrak{D}_\nu} \mathcal{E}(W_i^{-1}, \zeta_i). \quad (5.7)$$

Now, we can formalize the robust stabilization in the following theorem.

Theorem 5.1

For a given cycle ν in \mathfrak{C} and for a parameter $\mu \in (0, 1)$, assume that there exist $\{W_i, \zeta_i\}_{i \in \mathfrak{D}_\nu}$ in $\mathbb{S}^n \times \mathbb{R}^n$ and that are solutions to the following matrix inequalities

$$W_i \succ 0, \quad \Psi_i(A_{\nu(i)}^\ell, b_{\nu(i)}^\ell) \succ 0, \quad \forall (i, \ell) \in \mathfrak{D}_\nu \times \mathbb{L}, \quad (5.8)$$

where matrices Ψ_i 's depend on the system matrices and on the decision variables $\{W_i, \zeta_i\}_{i \in \mathfrak{D}_\nu}$ in $\mathbb{S}^n \times \mathbb{R}^n$ and are given by

$$\Psi_i(A_{\nu(i)}^\ell, b_{\nu(i)}^\ell)^a = \begin{bmatrix} (1 - \mu)W_i & 0 & W_i(A_{\nu(i)}^\ell)^\top \\ * & \mu & (A_{\nu(i)}^\ell \zeta_i + b_{\nu(i)}^\ell - \zeta_{[i+1]_\nu})^\top \\ * & * & W_{[i+1]_\nu} \end{bmatrix}. \quad (5.9)$$

Then, with the switching control law^b

$$u(x(k)) = \left\{ \nu(\theta), \theta \in \underset{i \in \mathfrak{D}_\nu}{\operatorname{argmin}} (x(k) - \zeta_i)^\top W_i^{-1} (x(k) - \zeta_i) \right\} \subset \mathbb{K}. \quad (5.10)$$

the following statements hold:

- (i) Attractor $\mathcal{S}_\nu = \bigcup_{i \in \mathfrak{D}_\nu} \mathcal{E}(W_i^{-1}, \zeta_i)$ is robustly globally exponentially stable for system (5.1)
- (ii) Moreover, if Assumption 5.1 holds, the min-switching law (5.10) converges ultimately to a shifted version of ν , *i.e.* there exists $k_0 \in \mathbb{N}$ and an integer $\delta \in \mathfrak{D}_\nu$ such that

$$u(x(k)) = \{\nu(k + \delta)\}, \quad \forall k \geq k_0. \quad (5.11)$$

^aFor the sake of simplicity, variables $\{W_i, \zeta_i\}_{i \in \mathfrak{D}_\nu}$ are omitted in the arguments of Ψ_i .

^b θ denotes the set of indexes $i \in \mathfrak{D}_\nu$ that minimize the quadratic function $(x(k) - \zeta_i)^\top W_i^{-1} (x(k) - \zeta_i)$

Proof. Let us consider the following candidate Lyapunov function

$$V(x(k)) = \min_{i \in \mathfrak{D}_\nu} (x(k) - \zeta_i)^\top W_i^{-1} (x(k) - \zeta_i), \quad \forall x(k) \in \mathbb{R}^n. \quad (5.12)$$

This function is identical to (4.13) given in the proof of Theorem 4.2 on page 52 except that the Lyapunov matrices P_i are replaced by W_i^{-1} and the vectors ρ_i 's are replaced by ζ_i 's, solution to the matrix inequalities (5.8).

Proof of (i): Following the proof of Theorem 4.2, one has

$$\begin{aligned} \Delta V(x(k)) &= \min_{j \in \mathfrak{D}_\nu} \left(x(k+1) - \zeta_j \right)^\top W_j^{-1} \left(x(k+1) - \zeta_j \right) \\ &\quad - \min_{i \in \mathfrak{D}_\nu} \left(x(k) - \zeta_i \right)^\top W_i^{-1} \left(x(k) - \zeta_i \right) \\ \Delta V(x(k)) &\leq \left(x(k+1) - \zeta_{\lfloor \theta+1 \rfloor_\nu} \right)^\top W_{\lfloor \theta+1 \rfloor_\nu}^{-1} \left(x(k+1) - \zeta_{\lfloor \theta+1 \rfloor_\nu} \right) \\ &\quad - \left(x(k) - \zeta_\theta \right)^\top W_\theta^{-1} \left(x(k) - \zeta_\theta \right). \end{aligned}$$

The objective is to express this last expression as a quadratic term. Closely to the manipulation performed for Theorem 4.2, we have that

$$\begin{aligned} x(k+1) - \zeta_{\lfloor \theta+1 \rfloor_\nu} &= A_{\nu(\theta)} x(k) + b_{\nu(\theta)} - \zeta_{\lfloor \theta+1 \rfloor_\nu} \\ &= A_{\nu(\theta)} (x(k) - \zeta_\theta) + \underbrace{A_{\nu(\theta)} \zeta_\theta + b_{\nu(\theta)} - \zeta_{\lfloor \theta+1 \rfloor_\nu}}_{:= \mathcal{B}_{\nu(\theta)}}. \end{aligned} \quad (5.13)$$

However, compared to the nominal case, vectors $A_{\nu(\theta)} \zeta_\theta + b_{\nu(\theta)} - \zeta_{\lfloor \theta+1 \rfloor_\nu}$ are not necessarily zero since vectors ζ_i 's are decision variables in inequalities (5.8); in Theorem 4.2, vectors ρ_i were computed *a priori*. In order to find an alternative solution, we introduce

$$\chi_\theta^\top(k) = \left[\left(W_\theta^{-1} (x(k) - \zeta_\theta) \right)^\top \quad 1 \right]^\top,$$

so that $x(k+1) - \zeta_{\lfloor \theta+1 \rfloor_\nu} = \begin{bmatrix} A_{\nu(\theta)} W_\theta & \mathcal{B}_{\nu(\theta)} \end{bmatrix} \chi_\theta(k)$. Hence, $\Delta V(x(k))$ can be rewritten in a more compact form

$$\Delta V(x(k)) \leq -\chi_\theta(k)^\top \Phi_\theta(A_{\nu(\theta)}, \mathcal{B}_{\nu(\theta)}) \chi_\theta(k), \quad (5.14)$$

with

$$\Phi_\theta(A_{\nu(\theta)}, \mathcal{B}_{\nu(\theta)}) = \begin{bmatrix} W_\theta & 0 \\ 0 & 0 \end{bmatrix} - \begin{bmatrix} W_\theta A_{\nu(\theta)}^\top \\ \mathcal{B}_{\nu(\theta)}^\top \end{bmatrix} W_{\lfloor \theta+1 \rfloor_\nu}^{-1} \begin{bmatrix} W_\theta A_{\nu(\theta)}^\top \\ \mathcal{B}_{\nu(\theta)}^\top \end{bmatrix}^\top.$$

Note that ΔV is not required to be negative in the whole state space, but only outside of set \mathcal{S}_ν . From the definition of the Lyapunov function, the control law given in (5.10) ensures that $V(x(k)) = (x(k) - \zeta_\theta)^\top W_\theta^{-1} (x(k) - \zeta_\theta)$. Therefore, if

$x(k)$ is assumed to be outside of \mathcal{S}_ν , inequality $(x(k) - \zeta_\theta)^\top W_\theta^{-1} (x(k) - \zeta_\theta) > 1$ holds and can be rewritten using the augmented vector $\chi_\theta(k)$ as follows

$$\begin{bmatrix} x(k) - \zeta_\theta \\ 1 \end{bmatrix}^\top \begin{bmatrix} W_\theta^{-1} & 0 \\ 0 & -1 \end{bmatrix} \begin{bmatrix} x(k) - \zeta_\theta \\ 1 \end{bmatrix} = \chi_\theta^\top(k) \begin{bmatrix} W_\theta & 0 \\ 0 & -1 \end{bmatrix} \chi_\theta(k) > 0. \quad (5.15)$$

Then, the problem can be summarized as the satisfaction of $\chi_\theta^\top(k) \Phi_\theta(A_{\nu(\theta)}, \mathcal{B}_{\nu(\theta)}) \chi_\theta(k) > 0$ (Equation (5.14)) for all $x(k)$ such that condition (5.15) holds. An S-procedure ensures that, if there exists a scalar $\mu \in (0, 1)$ such that

$$\begin{bmatrix} (1 - \mu)W_\theta & 0 \\ 0 & \mu \end{bmatrix} - \begin{bmatrix} W_\theta A_{\nu(\theta)}^\top \\ \mathcal{B}_{\nu(\theta)}^\top \end{bmatrix} W_{[\theta+1]\nu}^{-1} \begin{bmatrix} W_\theta A_{\nu(\theta)}^\top \\ \mathcal{B}_{\nu(\theta)}^\top \end{bmatrix}^\top \succ 0, \quad (5.16)$$

then, $\Delta V(x(k)) < 0$ for all $x(k) \notin \mathcal{S}_\nu$. Finally, a Schur's complement yields $\Psi_\theta(A_{\nu(\theta)}, b_{\nu(\theta)}) \succ 0$, for a fixed parameter μ , where matrix Ψ_θ is defined in (5.9). Since matrices $A_{\nu(\theta)}$ and $b_{\nu(\theta)}$ are uncertain, it is not yet possible to evaluate numerically these LMIs for all possible values of θ . However, since they belong to the polytopic set (5.2), one can define those matrices as convex combinations, with possibly time-varying weights

$$A_{\nu(\theta)} = \sum_{\ell \in \mathbb{L}} \alpha_\ell A_{\nu(\theta)}^\ell \quad \text{and} \quad b_{\nu(\theta)} = \sum_{\ell \in \mathbb{L}} \alpha_\ell b_{\nu(\theta)}^\ell, \quad (5.17)$$

where parameters $\alpha_\ell \in [0, 1]$ and hold $\sum_{\ell \in \mathbb{L}} \alpha_\ell = 1$. By noting that Ψ_θ are affine with respect to $A_{\nu(\theta)}$ and $b_{\nu(\theta)}$, it follows

$$\Psi_\theta(A_{\nu(\theta)}, b_{\nu(\theta)}) = \sum_{\ell \in \mathbb{L}} \alpha_\ell \Psi_\theta(A_{\nu(\theta)}^\ell, b_{\nu(\theta)}^\ell) \succ 0,$$

which is guaranteed by conditions (5.8). This guarantees that ΔV is negative definite outside of \mathcal{S}_ν . Exponential stability is obtained thanks to the strict inequalities (5.8). To conclude the proof, it remains to prove that the attractive set \mathcal{S}_ν is invariant. To do so, note that for any $x(k)$ is in \mathcal{S}_ν , i.e. $V(x(k)) < 1$, we have

$$\begin{aligned} V(x(k+1)) &= V(x(k)) + \Delta V(x(k)) \\ &= V(x(k)) - \mu(V(x(k)) - 1) + \Delta V(x(k)) + \mu(V(x(k)) - 1) \\ &\leq V(x(k)) - \mu(V(x(k)) - 1) \\ &\quad - \chi_\theta^\top(k) \left(\Phi_\theta(A_{\nu(\theta)}, \mathcal{B}_{\nu(\theta)}) - \mu \begin{bmatrix} W_\theta & 0 \\ 0 & -1 \end{bmatrix} \right) \chi_\theta(k) \\ &\leq (1 - \mu)V(x(k)) + \mu, \end{aligned}$$

which is guaranteed by (5.8). Then, since x is assumed to be in \mathcal{S}_ν and μ in $(0, 1)$, it holds $V(x(k+1)) \leq (1 - \mu) + \mu = 1$, guaranteeing that $x(k+1)$ also belongs to \mathcal{S}_ν .

Proof of (ii): The proof of this result is omitted because is similar to the proof of item (iii) in Theorem 4.2 from Chapter 4. \square

The previous theorem allows to design a control law that stabilizes uncertain system (5.1)–(5.2) at least to the attractor defined by set \mathcal{S}_ν given in (5.7), which is a union of shifted ellipsoids $\mathcal{S}_\nu = \cup_{i \in \mathfrak{D}_\nu} \mathcal{E}(W_i^{-1}, \zeta_i)$. Several comments on this robust stabilization result are provided in the next section.

5.3 Discussions regarding the main result

5.3.1 Robust limit cycle and comparison with the nominal case

A relevant byproduct of this theorem is an extension of the definition of limit cycles in equations (3.17) to the case uncertain switched affine systems, which can be expressed in terms of series of inclusions. More specifically, Theorem 5.1 states that, under the satisfaction of the conditions, the invariance of the attractor \mathcal{S}_ν ensures that the inclusions (5.4) hold. Besides, it is also relevant to understand how conservative the previous theorem is with respect to the nominal case, presented in Theorem 4.2 on page 52. The following proposition is stated.

Proposition 5.1

For a cycle ν in \mathfrak{C} such that there exist (P_i, ρ_i) in $\mathbb{S}^n \times \mathbb{R}^n$ for $i \in \mathfrak{D}_\nu$, respectively solution to

$$P_i \succ 0, \quad A_{\nu(i)}^\top P_{[i+1]_\nu} A_{\nu(i)} - P_i \prec 0, \quad \forall i \in \mathfrak{D}_\nu \quad (5.18)$$

and

$$\rho = (I_{nN_\nu} - \mathbf{A}_\nu)^{-1} \mathbf{B}_\nu \quad (5.19)$$

where the matrices \mathbf{A}_ν and \mathbf{B}_ν are the cyclic augmented matrices. Then, the following statements hold:

- (i) $(W_i, \zeta_i) = (\beta P_i^{-1}, \rho_i)$ is solution to (5.8), for any positive scalar $\beta > 0$, with a sufficiently small value of $\mu \in (0, 1)$.
- (ii) Moreover, since β is arbitrarily small and with $(W_i, \zeta_i) = (\beta P_i^{-1}, \rho_i)$,

$$\lim_{\beta \rightarrow 0^+} \mathcal{S}_\nu = \lim_{\beta \rightarrow 0^+} \bigcup_{i \in \mathfrak{D}_\nu} \mathcal{E}(P_i/\beta, \rho_i) = \bigcup_{i \in \mathfrak{D}_\nu} \{\rho_i\} = \mathcal{A}_\nu.$$

Equations (5.18) and (5.19) have been seen in Theorem 4.2 and Proposition 4.1 in the previous chapter.

$$\mathbf{A}_\nu = \begin{bmatrix} 0 & \dots & 0 & A_{\nu(N_\nu)} \\ A_{\nu(1)} & \ddots & 0 & 0 \\ \vdots & \ddots & \ddots & \vdots \\ 0 & \dots & A_{\nu(N_\nu-1)} & 0 \end{bmatrix}, \quad \mathbf{B}_\nu = \begin{bmatrix} b_{\nu(N_\nu)} \\ b_{\nu(1)} \\ \vdots \\ b_{\nu(N_\nu-1)} \end{bmatrix}.$$

Proof. Let us consider matrices P_i 's solution to inequalities (5.18) and vectors ρ_i solution to (5.19). For any positive scalar $\beta > 0$, let us set $(W_i, \zeta_i) = (\beta P_i^{-1}, \rho_i)$. Then $\mathcal{B}_{\nu(i)}$ from the definition of Ψ_i in (5.9) equals $\mathcal{B}_{\nu(i)} = A_{\nu(i)}\rho_i + b_{\nu(i)} - \rho_{[i+1]_\nu} = 0$, as defined in (5.13). For any $\mu \in (0, 1)$, $\Psi_i(A_{\nu(i)}^\ell, B_{\nu(i)}^\ell) \succ 0$ in (5.8) is equivalent to

$$\begin{bmatrix} (1 - \mu)P_i^{-1} & P_i^{-1}A_{\nu(i)}^\top \\ * & P_{[i+1]_\nu}^{-1} \end{bmatrix} \succ 0,$$

or, with a standard manipulation, equivalent to $A_{\nu(i)}^\top P_{[i+1]_\nu} A_{\nu(i)} - P_i \prec -\mu P_i$. The latter inequality being true for a small enough value $\mu > 0$, thanks to the strict inequality (5.18). Moreover, by noting that attractor \mathcal{S}_ν is composed by the ellipsoids given by $\mathcal{E}(P_i/\beta, \rho_i)$, for all $i \in \mathfrak{D}_\nu$ reduces to the union of singletons $\{\rho_i\}_{i \in \mathfrak{D}_\nu}$ as β tends to zero, which concludes the proof. \square

Remark 6. In light of the proof, since ellipsoids $\mathcal{E}(P_i/\beta, \rho_i)$ shrink to $\{\rho_i\}$, for all $i \in \mathfrak{D}_\nu$, inclusions (5.4) become exactly conditions (5.19) for the existence of a limit cycle in the nominal case. This demonstrates the consistency of the method.

The previous proposition states that there is no conservatism induced by Theorem 5.1 with respect to Theorem 4.2.

5.3.2 Minimization of the attractor's size

In the present form, the problem stated in Theorem 5.1 does not involved LMIs but BMIs due to the multiplication of decision variables such as $(1 - \mu)W_i$. However, this can be made convex by fixing the value of μ and facing thereafter an LMI problem. It can be then embed into a convex problem including an optimization with the idea to get small ellipsoids. In order to get an attractor \mathcal{S}_ν of "small" size, we can consider the optimization problem:

Problem 5.1: Minimization of the attractor's size

$$\text{minimize} \quad \text{Tr} \left(\text{diag} (W_i)_{i=1, \dots, N_\nu} \right) \quad (5.20)$$

$$\text{subject to} \quad (5.8) \quad (5.21)$$

Remark 7. While the objectives in Chapter 2 and Chapter 5 are different, the optimization problems are very similar; the matrices Ψ_i 's for $i \in \mathbb{K}$ in (2.8) are sensibly the same as matrices Ψ_i 's for $i \in \mathfrak{D}_\nu$ in (5.9). However, contrary to Theorem 2.1, the number of decision variables to fix is drastically reduced. It is then quite easy to develop an algorithm based on a gridding procedure to fix the value μ and search for the optimal solution to Problem 5.1.

5.4 Optimization

5.4.1 Motivations and preliminaries

The objective of this section is to include to the previous developments some additional constraints to conditions (5.8) aiming at selecting the decisions variables $\{W_i, \zeta_i\}_{i \in \mathcal{D}_\nu}$ that optimize a given cost function. This cost function has to be defined for each cycle and will not depend on the switched law. In addition, in practical situations and, in particular, in the context of power converters, the objective is to drive the solutions to the system as close as possible to a desired reference position, $x_d \in \mathbb{R}^n$.

Hence, it appears highly relevant that the cost function reflects not only the “distance” of the reference position to the attractor, but also the “size” of the attractor in order to limit the amplitude of the trajectories within the attractor. This will be considered in the remainder of this section. If the attractor is reduced to a single point of \mathbb{R}^n , the notion of distance is easy to be formalized. However, since this situation corresponds to a very particular case for the class of switched affine systems, we have to provide a sensible metric that also defines the distance of a point to the attractor. To go further in this direction, let us introduce the ellipsoid $\mathcal{E}(Q_\nu^{-1}, h_\nu)$ defined for some positive definite matrix Q_ν in \mathbb{S}^n and some shifting vector h_ν in \mathbb{R}^n to be optimized for a given cycle so that $\mathcal{E}(Q_\nu^{-1}, h_\nu)$ is the “smallest” ellipsoid verifying

$$(\{x_d\} \cup \mathcal{S}_\nu) \subset \mathcal{E}(Q_\nu^{-1}, h_\nu).$$

The next lemma helps expressing this inclusion as an LMI.

Lemma 5.1

For a given matrix Q_ν in \mathbb{S}_+^n and some shifting vector h in \mathbb{R}^n , let us define

$$\mathcal{K}_{Q_\nu, h}(W, \zeta, \eta) = \begin{bmatrix} \eta W & 0 & W \\ * & 1 - \eta & \zeta^\top - h^\top \\ * & * & Q_\nu \end{bmatrix}, \quad (5.22)$$

for some matrix $W \in \mathbb{S}_+^n$, a shifting vector ζ and a positive scalar η . Then, the following statements hold

- (i) ζ belongs to $\mathcal{E}(Q_\nu^{-1}, h)$ if and only if $\mathcal{K}_{Q_\nu, h}(0, \zeta, 0) \succeq 0$.
- (ii) $\mathcal{E}(W^{-1}, \zeta)$ is included in $\mathcal{E}(Q_\nu^{-1}, h)$ if and only if there exists a strictly positive scalar η such that $\mathcal{K}_{Q_\nu, h}(W, \zeta, \eta) \succeq 0$.

Proof. The proof of (i) is a direct application of the Schur complement. The proof of (ii) deserves a detailed proof. The problem is to ensure that $\mathcal{E}(W^{-1}, \zeta) \subset \mathcal{E}(Q_\nu^{-1}, h)$, meaning that inequality $(x - h)^\top Q_\nu^{-1} (x - h) \leq 1$ holds for all $x \in \mathbb{R}^n$ such that

$(x - \zeta)^\top W^{-1}(x - \zeta) \leq 1$. The inclusion can be rewritten as follows

$$\begin{aligned} \begin{bmatrix} \tilde{x} \\ 1 \end{bmatrix}^\top \left(\begin{bmatrix} 0 & 0 \\ 0 & 1 \end{bmatrix} - \begin{bmatrix} W \\ \zeta^\top - h^\top \end{bmatrix} Q_\nu^{-1} \begin{bmatrix} W \\ \zeta^\top - h^\top \end{bmatrix}^\top \right) \begin{bmatrix} \tilde{x} \\ 1 \end{bmatrix} &\geq 0, \\ \forall x \in \mathbb{R}^n \text{ s.t. } \begin{bmatrix} \tilde{x} \\ 1 \end{bmatrix}^\top \begin{bmatrix} -W & 0 \\ 0 & 1 \end{bmatrix} \begin{bmatrix} \tilde{x} \\ 1 \end{bmatrix} &\geq 0, \end{aligned}$$

where notation $\tilde{x} = W^{-1}(x - \zeta)$ simplifies the notation. The application of an S-procedure ensures that this problem is equivalent to the existence of a parameter $\eta > 0$ such that

$$\begin{bmatrix} \eta W & 0 \\ 0 & 1 - \eta \end{bmatrix} - \begin{bmatrix} W \\ \zeta^\top - h^\top \end{bmatrix} Q_\nu^{-1} \begin{bmatrix} W \\ \zeta^\top - h^\top \end{bmatrix}^\top \succeq 0.$$

A Schur complement yields the result. \square

In light of the previous lemma, we can state that inclusion $(\{x_d\} \cup \mathcal{S}_\nu) \subset \mathcal{E}(Q_\nu^{-1}, h)$ is equivalent to

$$Q_\nu \succ 0, \tag{5.23}$$

$$\mathcal{K}_{Q_\nu, h}(0, x_d, 0) \succeq 0, \tag{5.24}$$

$$\mathcal{K}_{Q_\nu, h}(W_i, \zeta_i, \eta) \succeq 0, \forall i \in \mathfrak{D}_\nu. \tag{5.25}$$

Remark 8. In the nominal case, the last inequality (5.25) can be reduced to

$$\mathcal{K}_{Q_\nu, h}(0, \rho_i, 0) \succeq 0, \forall i \in \mathfrak{D}_\nu.$$

5.4.2 Definition of cost functions

Following the previous developments, a possible way to formalize the notion of a cost related to a “distance” and/or a “size”, can be formulated as follows

$$J^*(\nu, x_d) := \min_{\{W_i, \zeta_i\}_{i \in \mathfrak{D}_\nu}} J(\nu, x_d, \{W_i, \zeta_i\}_{i \in \mathfrak{D}_\nu}) \tag{5.26}$$

s.t. (5.8) and potential additional inequalities.

where J is the cost function to be optimized and is defined as a barycenter of several families of costs (of course, not exhaustively), for instance

$$J(\nu, x_d, \{W_i, \zeta_i\}_{i \in \mathfrak{D}_\nu}) = \sum_{m=1}^4 \alpha_m J_m(\nu, x_d, \{W_i, \zeta_i\}_{i \in \mathfrak{D}_\nu}), \tag{5.27}$$

where $\alpha_m \geq 0$ and $\sum_{m=1}^4 \alpha_m = 1$ and where J_i 's are given by

- $J_1(\nu, x_d, \{\zeta_i\}_{i \in \mathfrak{D}_\nu}) = \omega_1$ with either

$$\begin{bmatrix} \omega_1 & x_d^\top - \frac{1}{N_\nu} \sum_{i \in \mathfrak{D}_\nu} \zeta_i^\top \\ * & I_n \end{bmatrix} \succ 0,$$

which minimizes the distance between the average value of the limit cycle and the desired reference, or

$$\begin{bmatrix} \omega_1 & (x_d - \zeta_1)^\top \Gamma & \cdots & (x_d - \zeta_{N_\nu})^\top \Gamma \\ * & I_n & & \\ * & * & \ddots & \\ * & * & * & I_n \end{bmatrix} \succ 0,$$

where Γ is a projection matrix (see for instance [36]), depending on an adequate notion of distance to a desired position denoted as $x_d \in \mathbb{R}^n$. Here, J_1 will allow to select a limit cycle closed in a certain sense to a desired position that is predefined by the designer.

- $J_2(\nu, x_d, \{W_i, \zeta_i\}_{i \in \mathfrak{D}_\nu}) = \omega_2$ with the additional inequalities

$$\begin{bmatrix} \omega_2 & (\zeta_i - \zeta_j)^\top \\ * & I \end{bmatrix} \succ 0, \quad \forall (i, j) \in \mathfrak{D}_\nu^2, i \neq j.$$

Cost J_2 aims at enforcing the shifts ζ_i 's to be the same value, that is to have a single shift for the ellipsoids.

- $J_3(\nu, x_d, \{W_i, \zeta_i\}_{i \in \mathfrak{D}_\nu}) = \text{Tr}(Q_\nu)$ with the additional inequalities given in (5.23). Hence, cost J_1 aims at optimizing the attractor. Indeed, this optimization problem is relevant to evaluate the ‘‘chattering’’ effect when the solution reaches the attractor.
- $J_4(\nu, x_d, \{W_i, \zeta_i\}_{i \in \mathfrak{D}_\nu}) = \text{Tr}(\text{diag}(W_i)_{i=1, \dots, N_\nu})$. Referring to Section 5.3.2, the criterion (5.20) might be also pertinent to optimize \mathcal{S}_ν by minimizing each ellipsoid's size.

Remark 9. This optimization problem can be stated using the formulation of Theorem 5.1 dealing with robust stabilization. However, as commented in Remark 6, the same problem can be formulated for the nominal case by simply replacing ζ_i by ρ_i in (5.26). This has led to the optimization section 4.4 where the LMIs involved in the definition of the cost functions J_1 and J_2 are replaced by equalities.

5.5 Example

Let us consider again the discrete-time switched affine system described by the following matrices

$$A_1 = \begin{bmatrix} 1 & 0 \\ 0 & 0.5 \end{bmatrix}, \quad A_2 = 4\sqrt{2} \begin{bmatrix} \cos\left(\frac{\pi}{4}\right) & -\sin\left(\frac{\pi}{4}\right) \\ \sin\left(\frac{\pi}{4}\right) & \cos\left(\frac{\pi}{4}\right) \end{bmatrix}, \quad b_1 = \begin{bmatrix} 0.01 & 0 \end{bmatrix}^\top, \quad b_2 = \begin{bmatrix} 0 & 0 \end{bmatrix}^\top. \quad (5.28)$$

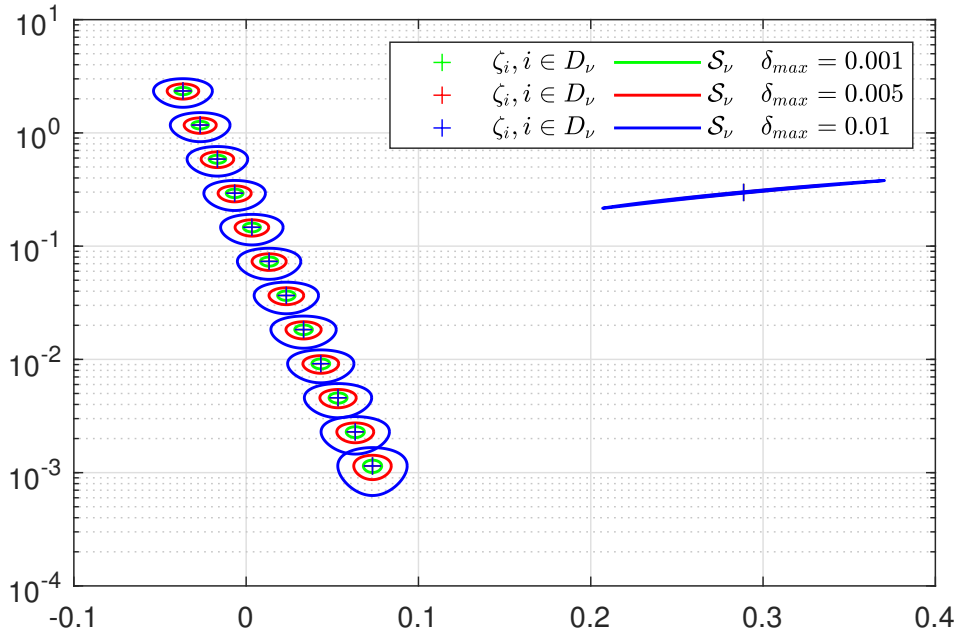

Figure 5.2: Illustration of the growth of the attractor's size in the state space obtained for several values of δ_{max} for system (5.28) subject to uncertainties (5.29). The ellipsoids are deformed due to the logarithmic scale.

In Chapter 4, we have shown that the cycle $\nu = \{1^{11}, 2^2\}$ generates a unique state limit cycle. The switching control law (6.27) developed ensures that the system (5.28)'s state is steered to the state limit cycle in question. Let us assume now that the system's matrices suffer from parameter uncertainties, described by

$$A_1 = \begin{bmatrix} 1 & 0 \\ 0 & 0.5 \pm \epsilon_1 \delta_{max} \end{bmatrix}, \quad b_1 = \begin{bmatrix} 0.01 \\ \pm \epsilon_2 \delta_{max} \end{bmatrix}, \quad (5.29)$$

where $\epsilon_1 = 0.01$ and $\epsilon_2 = 0.005$ and where δ_{max} is a parameter. Matrices A_2 and b_2 remain the same. Figure 5.2 shows the different attractors \mathcal{S}_ν obtained for various values of δ_{max} after performing a gridding procedure on parameter $\mu \in (0, 1)$ to the optimal solution of the LMI problem (5.1) together with the minimization of the cost function J with $\alpha = [0, 0, 0, 1]$. As expected, the size of the attractor grows with δ_{max} . Vectors ζ_i 's, solution to Theorem 5.1, are very close to the limit cycle $\{\rho_i\}_{i \in \mathfrak{D}_\nu}$ of the nominal case (for example, with $\delta_{max} = 0.01$, $\|\rho_i - \zeta_i\|_\infty \leq 10^{-3}$), which illustrates Proposition 5.1. One can see that the attractor obtained for the two smallest values of δ_{max} is the union of disjoint ellipsoids, so that the control law converges ultimately to a periodic law, verifying item (ii) of Theorem (5.1). Lastly, the evolution of the state variable with its dynamic affected by a perturbation $\delta_{max} = 0.01$ is plotted on Figure 5.3. The ordinate-axis is presented in a logarithmic scale to ease the differentiation between the ellipses. The figure shows the convergence of the state into the attractor. One can also see from this figure that the trajectory converges to the limit cycle.

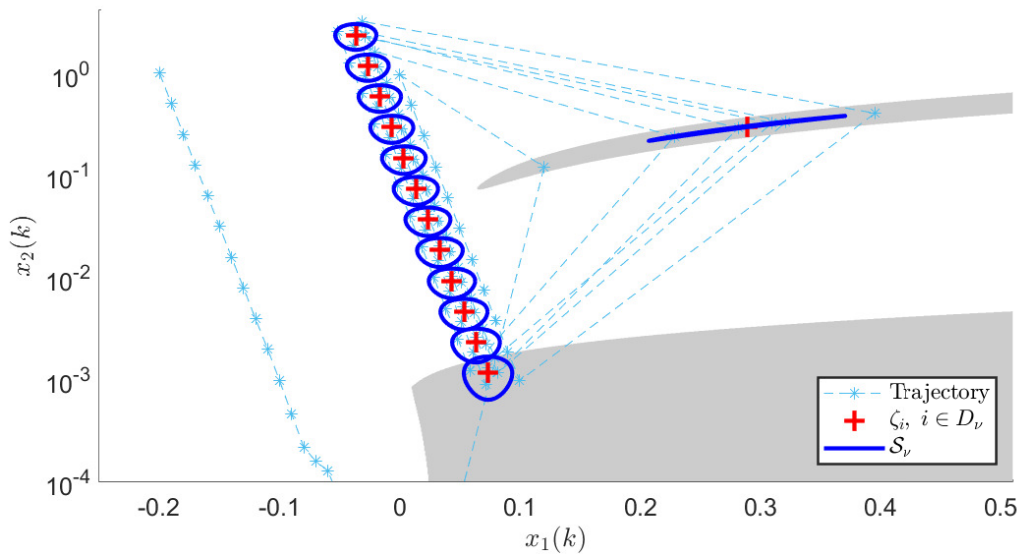

Figure 5.3: Trajectories of uncertain system (5.28)–(5.29) obtained for a perturbation $\delta_{max} = 0.01$ and converging to the attractor represented by the union of the blue ellipsoids in a semi-logarithmic space. The grey areas correspond to the regions of the state space, where the control law imposes to select mode 2, the complementary set being associated to mode 1.

5.6 Conclusion

Unlike other approaches from the literature, the solution given in Chapter 4 is suitable to be extending to the uncertain case, where the notion of limit cycles needs to be lightly modified.

Robust stabilization can be summarized as developing a control law to guarantee the boundedness of all trajectories $\{x(k)\}_{k \geq 1}$ of the closed-loop system (5.1)–(5.2) and as estimating the set containing these bounded trajectories asymptotically. While this set is usually defined as a single ellipsoid that is convex, this chapter has shown the design of a more complex set that may not be convex nor connected. Yet, the attractor's design results from the solution of the decision variables of an LMI problem.

To this LMI problem, it can be embedded a cost function to minimize which is especially useful while the designer is facing some practical situations. A comparison with the nominal case is made and showed that there is no conservatism induced by LMI problem (5.8)–(5.9) with respect to Theorem 4.2. Finally, the potential of the method is presented through an example already presented in Chapter 4.

6

Stabilization to limit cycles: the Hybrid Dynamical Systems formalism

From the end of Chapter 3 to Chapter 5, special attention has been paid to discrete switched affine systems and to hybrid limit cycles with discrete-time dynamics. The *hybrid limit cycles* for switched affine systems in continuous-time defined in Chapter 3 and is resumed in the present chapter. However, the control is a periodic time-triggered switching control law, therefore, one can still benefit from the literature on periodic systems. It will be of particular interest in Section 6.3.2 while characterizing the limit cycles. Due to this feature, most results of this chapter are closely related to the ones given in Chapter 4. In summary, the contributions of the stabilization of sampled-data switched affine systems to limit cycles are presented following these different points:

- The first section is dedicated to present the hybrid dynamical system paradigm and notions such as the data of hybrid systems definitions, the hybrid basic conditions on the data and the solution to some hybrid system.
- The switched affine system model is given in a second part using the formalism detailed just before.
- Then, the definition of hybrid limit cycles and the conditions of their existence are adapted to the current formalism and presented in Section 6.3.
- The remainder of the chapter concerns the stabilization result and illustrative examples with a short section on the selection of the cycle to minimize some cost functions.

6.1 Hybrid Dynamical Systems framework

Hybrid systems represent a class of dynamical systems that can be described by a combination of continuous- and discrete-time dynamics, and switching systems belong to a subclass of hybrid systems. It is then relevant to follow the paradigm given in [50] to model switched affine systems as hybrid dynamical systems. Let us first present some notions about general hybrid dynamical system as it is presented in [50].

The present section aims at presenting only the basic notions needed in the remaining sections, especially to comprehend the conditions of the result on stabilization.

6.1.1 Data of hybrid system

Any hybrid dynamical system can be represented by in the following form according to [50]:

$$\begin{cases} x \in \mathcal{C} & \dot{x} \in F(x) \\ x \in \mathcal{D} & x^+ \in G(x), \end{cases} \quad (6.1)$$

where x is the hybrid state, \dot{x} its time derivative and x^+ the value of the state after an instantaneous change. In this representation, it is suggested that the state x can change according to the differential inclusion $\dot{x} \in F(x)$ while x is in the set \mathcal{C} , and it can change according to the difference inclusion $x^+ \in G(x)$ while in the set \mathcal{D} . Also, the set-valued maps can be replaced by a less general representation with functions such that the state “flows” and “jumps” according to the differential equation $\dot{x} = f(x)$ and difference equation $x^+ = g(x)$ respectively.

Definition 6.1: Domain of a set-valued mapping

Given a set-valued mapping $M : \mathbb{R}^n \rightrightarrows \mathbb{R}^n$, the domain of M is the set

$$\text{dom } M := \{x \in \mathbb{R}^n : M(x) \neq \emptyset\}$$

For consistency in the model, it is required that F , respectively G , have nonempty values on \mathcal{C} , respectively \mathcal{D} . In the case of functions rather than set-valued maps, it is required that the functions f and g are defined at least on the set \mathcal{C} and \mathcal{D} respectively. It follows the definition of the data representing the hybrid system we denote $\mathcal{H} = (\mathcal{C}, F, \mathcal{D}, G)$ or simply \mathcal{H}

- a set $\mathcal{C} \subset \mathbb{R}^n$ is called the flow set.
- a set-valued mapping $F : \mathbb{R}^n \rightrightarrows \mathbb{R}^n$ with $\mathcal{C} \subset \text{dom } F$, is called the flow map.
- a set $\mathcal{D} \subset \mathbb{R}^n$ is called the jump set.
- a set-valued mapping $G : \mathbb{R}^n \rightrightarrows \mathbb{R}^n$ with $\mathcal{D} \subset \text{dom } G$, is called the jump map.

6.1.2 Hybrid time domain and solutions to hybrid systems

Hybrid dynamical systems framework is useful to represent systems described by a combination of continuous and discrete behavior. The solutions to a hybrid system \mathcal{H} are then parametrized in continuous-time by the variable $t \in \mathbb{R}_{\geq 0}$, which represents the amount of time passed, and in discrete-time by $k \in \mathbb{N}$, which represents the number of jumps that have occurred. Hence, related to that parametrization, we can define some subsets of $\mathbb{R}_{\geq 0} \times \mathbb{N}$.

Definition 6.2: Hybrid time domain

A subset $E \subset \mathbb{R}_{\geq 0} \times \mathbb{N}$ is a hybrid time domain if

$$E = \bigcup_{k=0}^{k > \bar{k}-1} ([t_k, t_{k+1}] \times \{k\}).$$

with \bar{k} finite (being E a compact hybrid time domain) or infinite.

Given a hybrid system \mathcal{H} , its solutions are functions ϕ that satisfy certain conditions determined by the hybrid time domain $\text{dom } \phi$ and by the data $(\mathcal{C}, F, \mathcal{D}, G)$ of \mathcal{H} [50, page 29-30].

Definition 6.3: Solution to a hybrid system

A function ϕ is a solution to the hybrid system $\mathcal{H} = (\mathcal{C}, F, \mathcal{D}, G)$, if:

1. the initial condition $\phi(0, 0) \in \bar{\mathcal{C}} \cup \mathcal{D}$, where $\bar{\mathcal{C}}$ denotes the closure of the set \mathcal{C} .
2. for all $k \in \mathbb{N}$ such that $I^k = \{t : (t, k) \in E\}$ has nonempty interior

$$\begin{aligned} \phi(t, k) &\in \mathcal{C} && \text{for all } t \in \text{int } I^k, \\ \dot{\phi}(t, k) &\in F(\phi(t, k)) && \text{for almost all } t \in I^k; \end{aligned} \quad (6.2)$$

3. for all $(t, k) \in \text{dom } \phi$ such that $(t, k+1) \in \text{dom } \phi$,

$$\begin{aligned} \phi(t, k) &\in \mathcal{D}, \\ \phi(t, k+1) &\in G(\phi(t, k)). \end{aligned} \quad (6.3)$$

There exists a classification of the solutions to hybrid systems depending on their hybrid time domains: *continuous*, *discrete*, *compact* to cite only a few. For instance, a solution ϕ to \mathcal{H} is *complete* if its hybrid time domain $\text{dom } \phi$ is unbounded.

6.1.3 Basic assumptions

The well-posed property of a hybrid system is a notion the authors of [50] have shown the importance, this is required at many occasion for the applicability of a large number of results presented in [50].

Assumption 6.1: Hybrid basic conditions

- (A1) The sets \mathcal{C} and \mathcal{D} are closed subsets of \mathbb{R}^n ;
- (A2) $F : \mathbb{R}^n \rightrightarrows \mathbb{R}^n$ is outer semicontinuous and locally bounded relative to \mathcal{C} , $\mathcal{C} \subset \text{dom } F$, and $F(x)$ is convex for every $x \in \mathcal{C}$;

(A3) $G : \mathbb{R}^n \rightrightarrows \mathbb{R}^n$ is outer semicontinuous and locally bounded relative to \mathcal{D} ,
 $\mathcal{D} \subset \text{dom } G$.

Theorem 6.1: Basic conditions and well-posedness [50, Theorem 6.30]

If a hybrid system $\mathcal{H} = (\mathcal{C}, F, \mathcal{D}, G)$ satisfies Assumption 6.1 then it is well-posed.

Proof. We invite the reader to see the proof of well-posedness in [50]. \square

6.1.4 Uniform global asymptotic stability of a compact set

Since the objective of the present chapter does not concern the convergence of the hybrid system to an equilibrium point but a hybrid limit cycle, it seems rather relevant to present the asymptotic stability of some compact set. Indeed, as it shall be demonstrated in one of the coming sections, the stabilization to a limit cycle can be proved in a two steps procedure by first considering an attractor. Hence, let us define the notion of stability for a compact set based on Lyapunov functions.

Theorem 6.2: Lyapunov Theorem for bounded attractors

Given a compact^a set \mathcal{A} and a hybrid system $\mathcal{H} = (\mathcal{C}, F, \mathcal{D}, G)$ satisfying Assumption 6.1, assume there exists a Lyapunov function candidate V for \mathcal{H} such that

$$(S) \quad V(x) = 0, \quad \forall x \in \mathcal{A}, \quad (6.4)$$

$$V(x) > 0, \quad \forall x \in \mathcal{C} \cup \mathcal{D} \cup G(\mathcal{D}) \setminus \mathcal{A}, \quad (6.5)$$

$$\lim_{|x| \rightarrow \infty} V(x) = \infty, \quad \forall x \in \mathcal{C} \cup \mathcal{D} \cup G(\mathcal{D}) \quad (6.6)$$

$$(F) \quad \langle \nabla V(x), f(x) \rangle < 0, \quad \forall x \in \mathcal{C} \setminus \mathcal{A}, f \in F(x) \quad (6.7)$$

$$(J) \quad V(g(x)) - V(x) < 0, \quad \forall x \in \mathcal{D} \setminus \mathcal{A}, g \in G(x) \quad (6.8)$$

$$G(\mathcal{A} \cap \mathcal{D}) \subset \mathcal{A} \quad (6.9)$$

then \mathcal{A} is Uniformly Globally Asymptotically Stable (UGAS) for \mathcal{H} .

^aA set \mathcal{A} is a compact set if and only if \mathcal{A} is closed and bounded.

Remark 10. Depending on the system \mathcal{H} and especially on the hybrid time domains of its solutions, equations (6.7) and (6.8) do not need to both hold. Indeed, in some circumstances, the conditions can be relaxed to non-strict inequalities and the asymptotic stabilization can still be guaranteed based on invariance principles, see [89] for instance.

6.2 Sampled-data switched affine model

6.2.1 System data

Consider the continuous-time switched affine system governed by

$$\begin{cases} \dot{x}(t) = F_{\sigma(t)}x(t) + g_{\sigma(t)}, & t \in \mathbb{R}, \\ \sigma(t) \in u(x(t_k)) \subseteq \mathbb{K}, & \forall t \in [t_k, t_{k+1}), k \in \mathbb{N}, \\ x_0 \in \mathbb{R}^n, \end{cases} \quad (6.10)$$

where $x(t) \in \mathbb{R}^n$ is the state vector and x_0 its initial condition, $\sigma(t) \in \mathbb{K} := \{1, 2, \dots, K\}$ is a sampled-data switching signal which indicates the active mode in each time period $[t_k, t_{k+1})$. The sequence $\{t_k\}_{k \in \mathbb{N}}$ is a strictly increasing sequence of time instants for which it is assumed that there exists a positive scalar T_s corresponding to the sampling period such that the difference between two successive sampling instants verifies

$$t_{k+1} - t_k = T_s > 0, \quad \forall k \in \mathbb{N}, \quad (6.11)$$

so that the sequence $\{t_k\}_{k \in \mathbb{N}}$ tends to infinity as k tends to infinity. Finally, in (6.10), the matrices (F_i, g_i) for $i \in \mathbb{K}$ are supposed to be known, constant and of suitable dimension.

6.2.2 A switched affine system as a hybrid dynamical system

Now considering switched affine systems, we can identify the continuous-time evolution of one hybrid system as the evolution of the system (6.10) state while the discrete behavior corresponds to the evolution of the switching signal. Meaning that system (6.10) can be modeled by the following hybrid system:

$$\begin{cases} x \in \mathbb{R}^n, \sigma \in \mathbb{K}, & \dot{x} = F_{\sigma}x + g_{\sigma}, \\ x \in \mathbb{R}^n, \sigma \in \mathbb{K}, & \sigma^+ \in u(x(t, k)). \end{cases} \quad (6.12)$$

In addition, a new variable can be introduced to represent a timer that accounts for the time elapsed since the last jump. In this representation, it is in particular indicated that the switching signal and the state vector $x \in \mathbb{R}^n$ remain constant while the triplet (x, σ, τ) is in \mathcal{C}_{σ} and in \mathcal{D}_{σ} , respectively. More formally, the sampled-data model written in the framework of hybrid dynamical system is given by

$$\mathcal{H}_\sigma : \begin{cases} \begin{bmatrix} \dot{x} \\ \dot{\sigma} \\ \dot{\tau} \end{bmatrix} = \begin{bmatrix} F_\sigma x + g_\sigma \\ 0 \\ 1 \end{bmatrix}, & (x, \sigma, \tau) \in \mathcal{C}_\sigma, \\ \begin{bmatrix} x^+ \\ \sigma^+ \\ \tau^+ \end{bmatrix} \in \begin{bmatrix} x \\ u(x, \sigma, \tau) \\ 0 \end{bmatrix}, & (x, \sigma, \tau) \in \mathcal{D}_\sigma, \end{cases} \quad (6.13)$$

where $(x, \sigma, \tau) \in \mathbb{H}_\sigma := \mathbb{R}^n \times \mathbb{K} \times [0, T_s]$ is the hybrid state vector, with $x \in \mathbb{R}^n$ the state of the switched affine system, $\sigma \in \mathbb{K}$ the switching signal and $\tau \in [0, T_s]$ the timer. The system is allowed to flow while the timer starting from zero is below the threshold imposed by T_s . Hence, the system jumps when the variable τ is equal to T_s and at this instant, the control law $u(x, \sigma, \tau)$ to be designed is computed. Hence, the sets \mathcal{C}_σ and \mathcal{D}_σ are given by

$$\mathcal{C}_\sigma = \mathbb{R}^n \times \mathbb{K} \times [0, T_s] \quad \text{and} \quad \mathcal{D}_\sigma = \mathbb{R}^n \times \mathbb{K} \times \{T_s\}. \quad (6.14)$$

6.2.3 Well-posedness of the system

Referring to Theorem 6.1, the hybrid system \mathcal{H}_σ enjoys of being well-posed as is given in the following proposition.

Proposition 6.1

Let us define the (set-valued) maps f_σ and G_σ as follows

$$f_\sigma := \begin{bmatrix} F_\sigma x + g_\sigma \\ 0 \\ 1 \end{bmatrix}, \quad G_\sigma := \begin{bmatrix} x \\ u(x, \sigma, \tau) \\ 0 \end{bmatrix}, \quad \forall (x, \sigma, \tau) \in \mathbb{H}_\sigma.$$

The system \mathcal{H}_σ with the data $(f_\sigma, G_\sigma, \mathcal{C}_\sigma, \mathcal{D}_\sigma)$ considered is well-posed.

Proof. Hybrid system (6.13)–(6.14) verifies the following properties

- The sets \mathcal{C}_σ and \mathcal{D}_σ are closed subsets of \mathbb{R}^n .
- f_σ is a continuous function over \mathcal{C}_σ , and consequently outer semicontinuous and locally bounded. Moreover, it is convex for each $(x, \sigma, \tau) \in \mathcal{C}_\sigma$.
- G_σ is outer locally bounded and semicontinuous.

According to [50, Assumption 6.5], these statements suffice to prove that system \mathcal{H}_σ is well-posed. \square

6.3 Limit cycles of switched affine systems

Through this section, the objective is to clarify the notion of *hybrid limit cycle* in the hybrid dynamical system framework but the definitions will be sensibly the same as the ones given in Chapter 3.

6.3.1 Definitions of limit cycles

Definition 6.4: Hybrid limit cycle

For a given complete solution ϕ^* to \mathcal{H}_σ , with a given state feedback $u^*(x, \sigma, \tau)$, the trajectory $(x, \sigma, \tau) = \phi^*(t, k)$, $(t, k) \in \text{dom } \phi^*$ is said to be a hybrid limit cycle under two conditions:

1. The solution ϕ^* is periodic, *i.e.* there exist a scalar $T > 0$ and an integer $N > 1$ such that

$$\phi^*(t+T, k+N) = \phi^*(t, k), \quad \forall (t, k) \in \text{dom } \phi^*.$$

2. The trajectory is isolated, *i.e.* for a given switching law, $u^*(x, \sigma, \tau)$, there exists no other periodic solution in its neighborhood.

Remark 11. Even if there is not a unique solution to system \mathcal{H}_σ due to the presence of the differential inclusion, the switching law $u^*(x, \sigma, \tau)$ must be periodic for the solution to be periodic. Therefore, at every jump instants, u^* is supposed to be a singleton.

Remark 12. Considering hybrid system (6.13), the timer τ induces a periodic jump with sampling period T_s , hence, for any periodic solution ϕ^* to \mathcal{H}_σ the equality $T = T_s N$ holds where T and N are the periods of ϕ^* .

Considering the hybrid system (6.13), the switching signal σ is a piecewise constant function. In the sequel, by switching sequence, we will refer to the sequence taken by $\sigma(t_k, k)$ and a periodic sequence will be referred as a cycle in a set \mathfrak{C} defined below. The following definition is a recall of Definition 3.5 in Chapter 3.

Definition 6.5: Set of cycles

Denote the set of cycles from \mathbb{N} to \mathbb{K} by

$$\mathfrak{C} := \left\{ \nu : \mathbb{N} \rightarrow \mathbb{K}, \text{ s.t. } \exists N \in \mathbb{N}, N > 1, \forall \ell \in \mathbb{N}, \nu(\ell + N) = \nu(\ell) \right\}. \quad (6.15)$$

Also, we recall that the minimal domain of a given cycle $\nu \in \mathfrak{C}$ is denoted as $\mathfrak{D}_\nu := \{1, 2, \dots, N_\nu\}$ and we use the following modulo notation in the remainder of the chapter

$$\lfloor \ell \rfloor_\nu^1 = ((\ell - 1) \bmod N_\nu) + 1, \quad \forall \ell \in \mathbb{N}, \ell \geq 1.$$

¹In particular, we have $\lfloor \ell \rfloor_\nu = \ell$, for any $\ell \in \mathfrak{D}_\nu$ and $\lfloor N_\nu + 1 \rfloor_\nu = 1$.

6.3.2 Necessary and sufficient conditions of existence

In the previous section, a quite general definition of *hybrid limit cycles* has been given. The interest is now to characterize the limit cycles of system (6.13). Since the hybrid state (x, σ, τ) lives periodically in \mathcal{D}_σ , it allows us to take benefit of the discrete-time (linear) periodic system literature as for instance [12, 15]. The necessary and sufficient conditions to the existence of a periodic solution of ϕ^* were introduced in Chapter 3 and are resumed here adapted to the hybrid systems framework. Let us first introduce some notations useful afterwards. Consider as in [82] the relation between two successive switching points given by

$$x(t_{k+1}, k) = \Phi_i(T_s)x(t_k, k) + \Gamma_i(T_s), \quad i \in \mathbb{K}, \quad (6.16)$$

where T_s is the sampling period and the time-varying matrices

$$\Phi_i(\tau) := e^{F_i \tau} \quad \text{and} \quad \Gamma_i(\tau) := \int_0^\tau e^{F_i(\tau-s)} g_i ds, \quad i \in \mathbb{K}, \quad (6.17)$$

where for the sake of readability we use $\tau = \tau(t, k)$.

Lastly, for a given cycle $\nu \in \mathfrak{C}$, denote the transition matrix over a period N_ν , namely the monodromy matrix, as

$$\bar{\Phi}_{\nu, \ell} := \prod_{i=\ell+1}^{\ell+N_\nu} \Phi_{\nu(i)}(T_s) \quad (6.18)$$

with ℓ representing a position in the cycle.

Lemma 6.1

For a given cycle $\nu \in \mathfrak{C}$, there exists a unique periodic solution $\phi^*(t, k)$ to \mathcal{H}_σ if and only if $\bar{\Phi}_{\nu, 0}$ does not have 1 as eigenvalue. If this assumption holds, the periodic solution is given by

$$\phi^* = \begin{bmatrix} x^*(t, k) \\ \sigma^*(t, k) \\ \tau(t, k) \end{bmatrix} = \begin{bmatrix} \rho(\tau, \lfloor k \rfloor_\nu) \\ \nu(k) \\ \tau(t, k) \end{bmatrix}, \quad \forall (t, k) \in \text{dom } \phi^*, \quad (6.19)$$

where

$$\rho(\tau, i) = \Phi_{\nu(i)}(\tau) \rho(0, i) + \Gamma_{\nu(i)}(\tau), \quad \forall i \in \mathfrak{D}_\nu. \quad (6.20)$$

Noticing that (6.20) holds for any $(t, k) \in \text{dom } \phi^*$, in particular, at each jump, as x^* remains constant, this implies, for all $k \in \mathbb{N}$.

$$\begin{aligned} \rho(0, \lfloor k+1 \rfloor_\nu) &= \rho(T_s, \lfloor k \rfloor_\nu) \\ &= \Phi_{\nu(k)}(T_s) \rho(0, \lfloor k \rfloor_\nu) + \Gamma_{\nu(k)}(T_s). \end{aligned}$$

Denoting the components $\rho_i := \rho(0, i)$ for $i \in \mathfrak{D}_\nu$ and gathering them in the vector $\rho = [\rho_1^\top, \dots, \rho_{N_\nu}^\top]^\top$, simple calculations yield the following relation

$$(I_{nN_\nu} - \mathbf{A}_\nu(T_s)) \rho := \mathbf{B}_\nu(T_s), \quad (6.21)$$

where $\mathbf{A}_\nu(\tau)$ and $\mathbf{B}_\nu(\tau)$ for all $\tau \in [0, T_s]$ are given by

$$\mathbf{A}_\nu(\tau) = \begin{bmatrix} 0 & \dots & 0 & \Phi_{\nu(N_\nu)}(\tau) \\ \Phi_{\nu(1)}(\tau) & \ddots & 0 & 0 \\ \vdots & \ddots & \ddots & \vdots \\ 0 & \dots & \Phi_{\nu(N_\nu-1)}(\tau) & 0 \end{bmatrix}, \quad (6.22)$$

$$\mathbf{B}_\nu(\tau) = \left[\Gamma_{\nu(N_\nu)}^\top(\tau) \quad \Gamma_{\nu(1)}^\top(\tau) \quad \dots \quad \Gamma_{\nu(N_\nu-1)}^\top(\tau) \right]^\top.$$

$$\mathbf{A}_\nu = \begin{bmatrix} 0 & \dots & 0 & \Phi_{\nu(N_\nu)}(\tau) \\ \Phi_{\nu(1)}(\tau) & \ddots & 0 & 0 \\ \vdots & \ddots & \ddots & \vdots \\ 0 & \dots & \Phi_{\nu(N_\nu-1)}(\tau) & 0 \end{bmatrix}.$$

Proof. Lemma 6.1 is a result giving the condition to the existence and uniqueness of the periodic solution for a given cycle. The *state limit cycle* $\rho(\tau, \lfloor k \rfloor_\nu), \forall (t, k) \in \text{dom } \phi^*$ is completely defined and is unique if there exists a solution to (6.21). Therefore, the proof is reduced to show that the condition on the monodromy matrix $\bar{\Phi}_{\nu,0}$ implies that (6.21) has a unique solution. First, it can be noticed that matrix $\mathbf{A}_\nu(T_s)$ has a close relation to matrix $\bar{\Phi}_{\nu,0}$, indeed the spectrum of the cyclic augmented matrix \mathbf{A}_ν is the set of all N_ν -roots of the n eigenvalues of the monodromy matrix (see the argument of [12, page 322, Section 3.2]) and we can add that, due to the structure of the matrices, the equation $\det(\mathbf{A}_\nu(T_s)) = \det(\bar{\Phi}_{\nu,0})$ holds. Hence, we infer that if the monodromy matrix does not have the eigenvalue 1, then, the matrix $(I_{nN_\nu} - \mathbf{A}_\nu(T_s))$ is non-singular and confirms the uniqueness of the periodic solution. \square

However, the condition stated is not strong enough to guarantee the existence of a hybrid limit cycle for system (6.13) because there exist periodic trajectories resulting from solution to (6.20)–(6.21) that are not isolated. The following Lemma presents the adequate conditions.

Lemma 6.2

For a given cycle $\nu \in \mathfrak{C}$, there exists a unique limit cycle for system (6.13) if and only if $\bar{\Phi}_{\nu,0}^M$ does not have 1 as eigenvalue where M is any strictly positive integer.

Proof. The proof is identical to the proof of Lemma 3.2 except for the notation. \square

6.4 Problem formulation

Recall the objective is to ensure the convergence and stability of any solution ϕ to ϕ^* of the hybrid system \mathcal{H}_σ . Therefore, it is more suited to rewrite \mathcal{H}_σ in a hybrid system that depends on the position of cycle (it will be defined by variable θ), instead of the functioning mode σ . We denote the hybrid state vector by $\xi := (x, \theta, \tau)$ and we define the hybrid system \mathcal{H}_θ as following

$$\mathcal{H}_\theta : \begin{cases} \dot{\xi} = f(\xi), & \xi \in \mathcal{C}, \\ \xi^+ \in G(\xi), & \xi \in \mathcal{D}, \end{cases} \quad (6.23)$$

with the (set-valued) maps f and G given now by

$$f(\xi) := \left[\left(F_{\nu(\theta)}x + g_{\nu(\theta)} \right)^\top, 0, 1 \right]^\top \quad \text{and} \quad G(\xi) := \left[x^\top, u(\xi), 0 \right]^\top.$$

Since, only the variable σ from \mathcal{H}_σ has been replaced by θ which lies in \mathfrak{D}_ν , the hybrid state vector ξ belongs to the set $\mathbb{H}_\theta := \mathbb{R}^n \times \mathfrak{D}_\nu \times [0, T_s]$. Likewise, the flow set and the jump set are now

$$\mathcal{C} = \mathbb{R}^n \times \mathfrak{D}_\nu \times [0, T_s] \quad \text{and} \quad \mathcal{D} = \mathbb{R}^n \times \mathfrak{D}_\nu \times \{T_s\}. \quad (6.24)$$

Note that the well-posedness property of the hybrid system \mathcal{H}_σ is inherited for this new hybrid system \mathcal{H}_θ .

Now, we are in position of formulating the problem.

Problem 6.1

Consider the hybrid system \mathcal{H}_θ . then the objectives are:

- (i) To select a limit cycle \mathcal{A}_ν according to some system specifications: position of each ρ_i , $i \in \mathfrak{D}_\nu$, to the operating point and amplitude of the trajectories.
- (ii) To design a control law that ensures the uniformly globally asymptotically stability of the selected limit cycle.

6.5 Design of the hybrid switching rule

Stability properties of a limit cycle of hybrid system \mathcal{H}_θ associated to a given cycle $\nu \in \mathfrak{C}$ is analyzed here and latter we will focus on the selection of a limit cycle.

Theorem 6.3

For a cycle ν in \mathfrak{C} , assume that there exist symmetric positive definite matrices P_i in \mathbb{S}_+^n , for $i \in \mathfrak{D}_\nu$, solution to the following inequalities

$$P_i \succ 0, \quad \Phi_{\nu(i)}^\top(T_s) P_{[i+1]_\nu} \Phi_{\nu(i)}(T_s) - P_i \prec 0, \quad \forall i \in \mathfrak{D}_\nu. \quad (6.25)$$

Then, these statements hold:

(i) Eq. (6.21) admits a unique solution ρ .

(ii) The set

$$\mathcal{A}_\nu := \left\{ \xi \in \mathbb{H}_\sigma : \xi = \begin{bmatrix} \rho(\tau, i) \\ \nu(i) \\ \tau \end{bmatrix}, \quad \forall i \in \mathfrak{D}_\nu \right\}. \quad (6.26)$$

is an attractor and is uniformly globally asymptotically stable for system (6.23) with the control law

$$u(\xi) = \left\{ \arg \min_{i \in \mathfrak{D}_\nu} (x - \rho(\tau, i))^\top \mathbb{P}_i(\tau) (x - \rho(\tau, i)) \right\} \subset \mathbb{K}. \quad (6.27)$$

(iii) Moreover, if the components $\{\rho_i\}_{i \in \mathfrak{D}_\nu}$ are two by two different, then there exist $k_0 \in \mathbb{N}$ and an integer $\delta \in \mathfrak{D}_\nu$ such that

$$u(\xi(t_k, k)) = \{\nu(k + \delta)\}, \quad \forall k \geq k_0. \quad (6.28)$$

Proof. Each item shall be proven one by one. It should be noticed that proof of (i) and (iii) have already been presented in Chapter 4 (see proof of Proposition 4.1 and proof of Theorem 4.2). They are reported here with modifications regarding the hybrid system formalism for consistency. Also, the proof of item (ii) relies on the application of [89, Theorem 1].

Proof of (i): Let us consider $\bar{P} = \text{diag}_{i=1}^{N_\nu} P_i$ solution to (6.25). Therefore, we can see that

$$\mathbf{A}_\nu^\top(T_s) \bar{P} \mathbf{A}_\nu(T_s) - \bar{P} = \text{diag}_{i=1}^{N_\nu} \left(\Phi_{\nu(i)}^\top(T_s) P_{[i+1]_\nu} \Phi_{\nu(i)}(T_s) - P_i \right) \prec 0. \quad (6.29)$$

Hence, matrix $\mathbf{A}_\nu(T_s)$ is Schur stable and we have a sufficient condition derived from the one in Lemma 6.2.

Proof of (ii): Let us now consider the candidate Lyapunov function given by

$$V(\xi) = (x - \rho(\tau, \theta))^\top \mathbb{P}_\theta(\tau) (x - \rho(\tau, \theta)), \quad \forall \xi \in \mathbb{H}_\theta, \quad (6.30)$$

where

$$\mathbb{P}_i(\tau) := e^{-F_{\nu(i)}^\top \tau} P_i e^{-F_{\nu(i)} \tau} = \Phi_{\nu(i)}^\top(-\tau) P_i \Phi_{\nu(i)}(-\tau), \quad \forall i \in \mathfrak{D}_\nu.$$

Function $V(\xi)$ is locally Lipschitz, radially unbounded and the positive definiteness of matrices P_i 's, clearly implies its strict positiveness for all $\xi \notin \mathcal{A}_\nu$; $V(\xi) = 0$ otherwise. To continue the proof, one shall ensure that the derivative of $V(\xi)$ along the flows is non positive for all $\xi \in \mathcal{C} \setminus \mathcal{A}_\nu$ and that the difference of $V(\xi)$ across the jumps is non positive for all $\xi \in \mathcal{D} \setminus \mathcal{A}_\nu$, roughly speaking, the next two inequalities need to hold

$$\langle \nabla V(\xi), f(\xi) \rangle \leq 0 \quad \forall \xi \in \mathcal{C} \setminus \mathcal{A}_\nu, \quad (6.31)$$

$$\Delta V(\xi) := V(\xi^+) - V(\xi) \leq 0 \quad \forall \xi \in \mathcal{D} \setminus \mathcal{A}_\nu. \quad (6.32)$$

First, note that during flows $\dot{\rho}(\tau, \theta) = F_{\nu(\theta)}\rho(\tau, \theta) + g_{\nu(\theta)}$, which is direct from the definition given before ($x^*(t, k) = \rho(\tau, \lfloor k \rfloor_\nu$). Hence, next equations hold

$$\frac{d}{dt} [x(t) - \rho(\tau, \theta)] = F_{\nu(\theta)} (x(t) - \rho(\tau, \theta)), \quad (6.33)$$

$$\frac{d}{dt} \mathbb{P}_\theta(\tau) = - \left(F_{\nu(\theta)}^\top \mathbb{P}_\theta(\tau) + \mathbb{P}_\theta(\tau) F_{\nu(\theta)} \right). \quad (6.34)$$

The expression of $\langle \nabla V(\xi), f(\xi) \rangle$ for any $\xi \in \mathcal{C} \setminus \mathcal{A}_\nu$ is given by

$$\begin{aligned} \langle \nabla V(\xi), f(\xi) \rangle &= (x - \rho(\tau, \theta))^\top \frac{d}{dt} \mathbb{P}_\theta(\tau) (x - \rho(\tau, \theta)) \\ &\quad + 2 \frac{d}{dt} (x - \rho(\tau, \theta))^\top \mathbb{P}_\theta(\tau) (x - \rho(\tau, \theta)) = 0. \end{aligned} \quad (6.35)$$

Since the latter equation is equal to zero for all $\xi \in \mathcal{C}$, *i.e.* the Lyapunov function remains constant along flows. It is then necessary to have $\Delta V(\xi)$ negative for all $\xi \in \mathcal{D} \setminus \mathcal{A}_\nu$ in order to obtain the desired convergence. The difference of $V(\xi)$ across the jumps can be expressed as follows

$$\begin{aligned} \Delta V(x, \theta, \tau) &:= V(x^+, \theta^+, \tau^+) - V(x, \theta, \tau) \\ &= V(x, u(x, \theta, \tau), 0) - V(x, \theta, T_s) \end{aligned}$$

The control law selects the argument $i \in \mathfrak{D}_\nu$ that minimizes the quadratic term $(x - \rho(\tau, i))^\top \mathbb{P}_i(\tau) (x - \rho(\tau, i))$, hence we have

$$V(x, u(\xi), 0) \leq V(x, j, 0), \quad \forall j \in \mathfrak{D}_\nu.$$

In particular, selecting $j = \lfloor \theta + 1 \rfloor_\nu$ yields

$$\begin{aligned} \Delta V(x, \theta, \tau) &\leq V(x, \lfloor \theta + 1 \rfloor_\nu, 0) - V(x, \theta, T_s) \\ &\leq (x - \rho(0, \lfloor \theta + 1 \rfloor_\nu))^\top \mathbb{P}_{\lfloor \theta + 1 \rfloor_\nu} (x - \rho(0, \lfloor \theta + 1 \rfloor_\nu)) \\ &\quad - (x - \rho(T_s, \theta))^\top \mathbb{P}_\theta(T) (x - \rho(T, \theta)) \end{aligned}$$

Thanks to equation (6.20) that guarantees that $\rho(T_s, \theta) = \rho(0, \lfloor \theta + 1 \rfloor_\nu) := \rho_{\lfloor \theta + 1 \rfloor_\nu}$, the following simplification can be made

$$\begin{aligned} \Delta V(x, \theta, \tau) &\leq (x - \rho_{\lfloor \theta + 1 \rfloor_\nu})^\top \left(\mathbb{P}_{\lfloor \theta + 1 \rfloor_\nu}(0) - \mathbb{P}_\theta(T_s) \right) (x - \rho_{\lfloor \theta + 1 \rfloor_\nu}) \\ &\leq (x - \rho_{\lfloor \theta + 1 \rfloor_\nu})^\top \left(P_{\lfloor \theta + 1 \rfloor_\nu} - \Phi_{\nu(\theta)}(-T_s) P_\theta \Phi_{\nu(\theta)}(T_s) \right) (x - \rho_{\lfloor \theta + 1 \rfloor_\nu}) \\ &\leq \chi^\top \left(\Phi_{\nu(\theta)}^\top(T_s) P_{\lfloor \theta + 1 \rfloor_\nu} \Phi_{\nu(\theta)}(T_s) - P_\theta \right) \chi \\ &< 0 \end{aligned}$$

where $\chi = \Phi_{\nu(\theta)}(T_s) (x - \rho_{\lfloor \theta + 1 \rfloor_\nu})$. The last inequality is ensured from the satisfaction of the LMIs (6.25). To complete the proof based on the [89, Theorem 1], it is still required the satisfaction of $G(\mathcal{D} \cap \mathcal{A}_\nu) \subset \mathcal{A}_\nu$ which define the invariant character of set \mathcal{A}_ν . The intersection between sets \mathcal{D} and \mathcal{A}_ν can be written as follows

$$\mathcal{D} \cap \mathcal{A}_\nu := \left\{ \xi \in \mathbb{H}_\theta : x = \rho(T_s, \theta) = \rho_{\lfloor \theta + 1 \rfloor_\nu}, \theta \in \mathfrak{D}_\nu, \tau = T_s \right\}.$$

Note, the set-valued map G does not modify the state x ; only the switching signal θ and the timer τ change. Therefore, $G(\mathcal{D} \cap \mathcal{A}_\nu) \subset \mathcal{A}_\nu$ is ensured.

Proof of (iii): The proof of the last item is obtained by showing that there exists a sufficiently small and positive ϵ such that if solutions to \mathcal{H}_θ evolve in

$$\mathcal{S}_\epsilon = \{ \xi(t_k, k) \in \mathbb{H}_\theta, V(\xi) \leq \epsilon^2 \},$$

then the following condition is satisfied:

$$(x(t_{k+1}, k) - \rho_{\lfloor \theta + 1 \rfloor_\nu})^\top P_{\lfloor \theta + 1 \rfloor_\nu} (x(t_{k+1}, k) - \rho_{\lfloor \theta + 1 \rfloor_\nu}) < (x(t_{k+1}, k) - \rho_j)^\top P_j (x(t_{k+1}, k) - \rho_j), \quad (6.36)$$

for all $j \in \mathfrak{D}_\nu$, with $j \neq \lfloor \theta + 1 \rfloor_\nu$, that is the solution of the next optimization problem (6.27) is $\lfloor \theta + 1 \rfloor_\nu$. Remember that $V(\xi)$ does not change during flows. The convergence of the Lyapunov function to zero has been proven, hence, reaching the level set \mathcal{S}_ϵ is always possible. The shift δ from equation (6.28) is determined at time k_0 (related to the time needed to reach \mathcal{S}_ϵ) thanks to the solution θ of the optimization problem. One should notice that thanks to the equivalence of weighted norms, there exists constants $c_{i,j} > 0$, $\forall (i, j) \in \mathfrak{D}_\nu$, such that

$$\|x\|_{P_i} \leq c_{i,j} \|x\|_{P_j}. \quad (6.37)$$

For example, it is always possible to select $c_{i,j} = \sqrt{\lambda_M(P_i)/\lambda_m(P_j)}$. Then, thanks to item (ii) and $\xi \in \mathcal{S}_\epsilon$, we have,

$$\|x(t_{k+1}, k) - \rho_{\lfloor \theta + 1 \rfloor_\nu}\|_{P_{\lfloor \theta + 1 \rfloor_\nu}} \leq \|x(t_k, k) - \rho_\theta\|_{P_\theta} \leq \epsilon. \quad (6.38)$$

Now, from the fact that ξ is in \mathcal{S}_ϵ , together with equations (6.16) and (6.20), it follows

$$\begin{aligned} \|x(t_{k+1}, k) - \rho_{\lfloor \theta + 1 \rfloor_\nu}\|_{P_\theta} &= \|\Phi_{\nu(\theta)}(T_s)(x(t_k, k) - \rho_\theta)\|_{P_\theta} \\ &\leq \|\Phi_{\nu(\theta)}(T_s)\|_{P_\theta} \|x(t_k, k) - \rho_\theta\|_{P_\theta}, \\ &\leq \|\Phi_{\nu(\theta)}(T_s)\|_{P_\theta} \epsilon. \end{aligned}$$

where $\|\Phi_{\nu(\theta)}(T_s)\|_{P_\theta}$ denotes the matrix norm induced by the weighted norm $\|\cdot\|_{P_\theta}$. Due to relations (6.37) and triangular inequalities, it yields

$$\begin{aligned} & \|\rho_{[\theta+1]_\nu} - \rho_j\|_{P_\theta} - \|\Phi_{\nu(\theta)}(T_s)\|_{P_\theta} \epsilon \\ & \leq \|\rho_{[\theta+1]_\nu} - \rho_j\|_{P_\theta} - \|\Phi_{\nu(\theta)}(T_s)(x(t_k, k) - \rho_\theta)\|_{P_\theta}, \\ & \leq \|\rho_{[\theta+1]_\nu} - \rho_j + \Phi_{\nu(\theta)}(T_s)(x(t_k, k) - \rho_\theta)\|_{P_\theta}, \\ & \leq \|x(t_{k+1}, k) - \rho_j\|_{P_\theta}, \\ & \leq c_{\theta,j} \|x(t_{k+1}, k) - \rho_j\|_{P_j}, \quad \forall j \in \mathfrak{D}_\nu. \end{aligned}$$

Under the condition that all ρ_i 's are different two by two, it is always possible to find a positive scalar ϵ such that the strict inequalities $0 < c_{\theta,j} \epsilon < \|\rho_{[\theta+1]_\nu} - \rho_j\|_{P_\theta} - \|\Phi_{\nu(\theta)}(T_s)\|_{P_\theta} \epsilon$ hold for any $j \in \mathfrak{D}_\nu$, $j \neq [\theta+1]_\nu$. Combining the two latter inequalities leads to

$$\epsilon < \|x(t_{k+1}, k) - \rho_j\|_{P_j}, \quad \forall j \in \mathfrak{D}_\nu \setminus \{[\theta+1]_\nu\}. \quad (6.39)$$

Comparing inequalities (6.38) and (6.39) concludes

$$\|x(t_{k+1}, k) - \rho_{[\theta+1]_\nu}\|_{P_{[\theta+1]_\nu}} \leq \epsilon < \|x(t_{k+1}, k) - \rho_j\|_{P_j}, \quad \forall j \in \mathfrak{D}_\nu \setminus \{[\theta+1]_\nu\},$$

which ends the proof. \square

Remark 13. At many occasions, the objective is to steer the state of the switched system as close as possible to a desired reference point $x_d \in \mathbb{R}^n$ to meet some practical specifications. Usually, it is first required to perform a change of coordinates in order to locate the desired operating point at the origin. However, Proposition 3.1 in Chapter 3 states that there is no need to apply any transformation in a view of stabilizing the system to a specific state limit cycle.

6.6 Optimization

In Chapter 4, different solutions to define a cost function associated to a limit cycle were presented to evaluate the performance of a limit cycle. To constrain the amplitude of the oscillations around the desired point, we consider here the following cost function:

$$J(\nu, x_d, \rho) = J_1(\nu, \rho) + J_2(\nu, x_d, \rho), \quad \forall (x_d, (\rho, \nu, T_s)) \in \mathbb{R}^n \times \mathcal{A}_\nu, \quad (6.40)$$

where

$$\begin{aligned} J_1(\nu, \rho) &= \sup_{i \in \mathfrak{D}_\nu} \left(\sup_{j \in \mathfrak{D}_\nu} (\rho_i - \rho_j)^\top H_1 (\rho_i - \rho_j) \right), \\ J_2(\nu, x_d, \rho) &= \left(x_d - \frac{1}{N_\nu} \sum_{i \in \mathfrak{D}_\nu} \rho_i \right)^\top H_2 \left(x_d - \frac{1}{N_\nu} \sum_{i \in \mathfrak{D}_\nu} \rho_i \right). \end{aligned}$$

The cost function defined in (6.40) can be seen as a particular possible expression, which is based on the knowledge of $\rho_i = \rho(0, i)$, $i \in \mathfrak{D}_\nu$. It might be possible to consider more complex cost functions which consider the whole arcs $(\rho(\tau, i), i, \tau)$ in \mathcal{A}_ν .

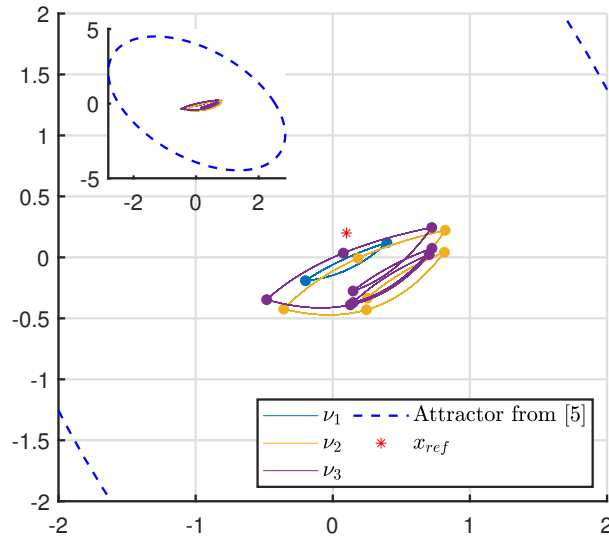

Figure 6.1: Comparison between the attractive set from [5] and some limit cycles for $T_s = 0.6s$. Note the window in the top-left corner giving a full view of the above mentioned attractor (Example 1).

Problem 6.2

For a given bounded subset $\Omega \subset \mathfrak{C}$ such that for any $\mu \in \Omega$, the monodromy matrix $\bar{\Phi}_{\mu,0}$ is Schur, and for a given desired reference x_d , the optimal switching control law is associated to the following optimization

$$\nu = \operatorname{argmin}_{\mu \in \Omega} J(\mu, x_d, \rho) \tag{6.41}$$

We will consider henceforth the limit cycles that minimize the precedent optimization problem.

6.7 Examples

In this section, different examples allow us to illustrate the results presented in this paper.

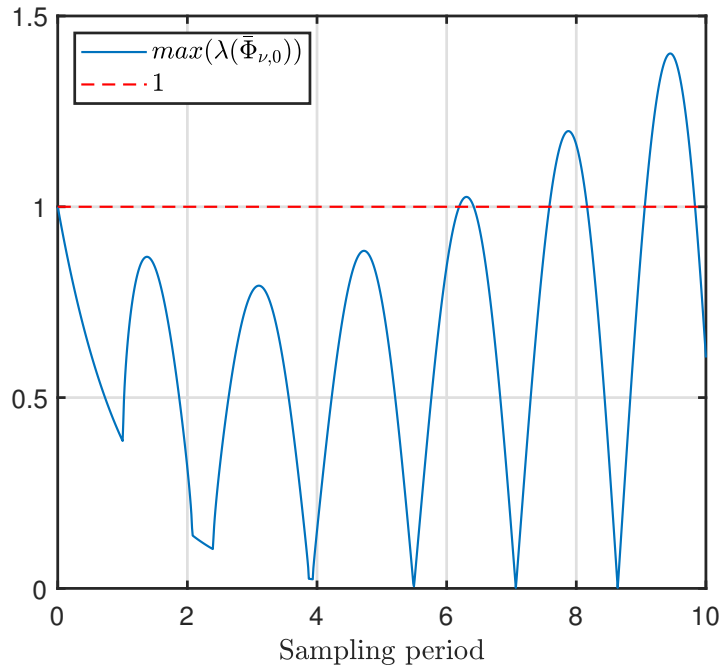

Figure 6.2: Illustration of the max absolute characteristic multiplier of the monodromy matrix for the cycle $\nu_4 = [3 \ 3 \ 2 \ 1]$ (Example 1).

6.7.1 Example 1

This first example is borrowed from [5]. The continuous system of the form (6.10) is composed by the three following unstable modes :

$$\begin{aligned}
 F_1 &= \begin{bmatrix} 0 & 0.5 \\ 0 & -1 \end{bmatrix}, & F_2 &= \begin{bmatrix} 0.1 & 0 \\ -1 & -1 \end{bmatrix}, & F_3 &= \begin{bmatrix} 0 & 1 \\ -1 & 0 \end{bmatrix}, \\
 g_1 &= \begin{bmatrix} 1 \\ 0.5 \end{bmatrix}, & g_2 &= \begin{bmatrix} -1 \\ -0.5 \end{bmatrix}, & g_3 &= \begin{bmatrix} 0 \\ 2 \end{bmatrix}.
 \end{aligned} \tag{6.42}$$

To compare the results obtained in [5] with ours, we consider the desired equilibrium point $x_d = [0.1 \ 0.2]^\top$. The method employed to guarantee the stabilization of the system in the vicinity of x_d in [5] is to define an attractive set where the state must converge. In order to achieve this objective, they propose an *event-triggered* control law and a *periodic time-triggered* control law. Even if only a periodic control law is investigated in the present paper, the method allows to reduce significantly the size of the attractive set, especially when the sampling time grows. In order to highlight the size differences, Figure 6.1 depicts some optimal state limit cycles of different lengths selected thanks to the minimization of $J(\nu, x_d, \rho)$ by limiting the search to cycles of period less than or equal to 8 and by selecting $H_1 = H_2 = I$. The three cycles obtained solving the optimization problem (6.41) are given by

$$\nu_1 = [2 \ 1], \quad \nu_2 = [2 \ 1 \ 2 \ 2 \ 1 \ 1], \quad \nu_3 = [2 \ 1 \ 2 \ 1 \ 2 \ 2 \ 1 \ 1].$$

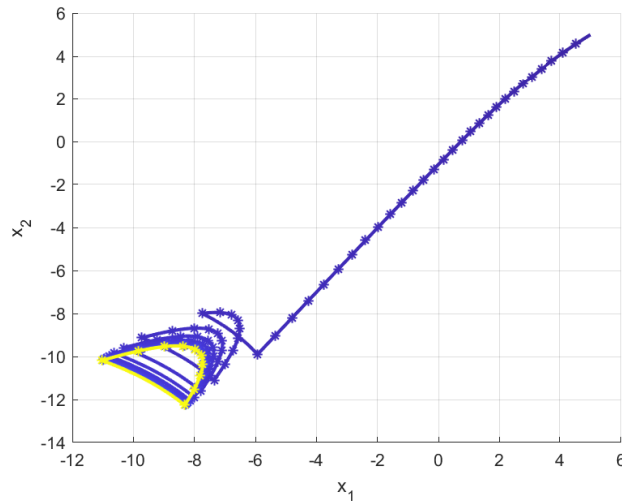

Figure 6.3: Evolution of the state in the phase plan (Example 2).

One can see that the cycles selected do not contain the mode 3, therefore, the control law is restricted since only a subset of \mathbb{K} is considered. It should be noted that restriction affects mainly the transient time. In addition, on Figure 6.2, the maximal absolute characteristic multiplier of the monodromy matrix is illustrated for an arbitrarily selected cycle regarding the sampling time.

6.7.2 Example 2

This example has been presented by [36] and resumed in [38]. In the latter, they introduced several control laws to guarantee the global asymptotic stability of predefined limit cycles. Consider system (6.10) with the following data

$$F_1 = \begin{bmatrix} -4 & -3 \\ -3 & 2.5 \end{bmatrix}, \quad F_2 = \begin{bmatrix} 4 & -1 \\ 1 & -2 \end{bmatrix}, \quad g_1 = \begin{bmatrix} 0 \\ -2 \end{bmatrix}, \quad g_2 = \begin{bmatrix} 0 \\ 8 \end{bmatrix}. \quad (6.43)$$

The objective is to make converge the state as near as possible to the reference

$$x_d = \begin{bmatrix} -9 & \star \end{bmatrix}^\top$$

where \star means that the second value in steady-state has no importance. This means that we have selected matrices H_1 and H_2 parametrizing the cost function (6.40) to optimize it only with respect to the first value of x_d , *i.e* we have chosen

$$H_1 = H_2 = \begin{bmatrix} 1 & 0 \\ 0 & 0 \end{bmatrix}.$$

Using the cost function (6.40) to evaluate the candidate stable cycles allows us to determine that the cycle $\nu^\star = \begin{bmatrix} 1 & 1 & 1 & 1 & 1 & 1 & 1 & 1 & 1 & 2 \end{bmatrix}^\top$ generates the closest

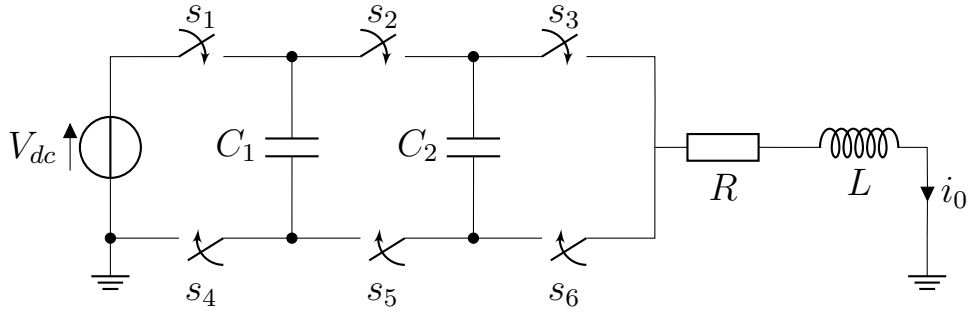

Figure 6.4: Schematic of a three-cell converter (Example 3).

state limit cycle to x_d . Unfortunately, we were unable to repeat the simulation made by [38]. A quick comparison allows us to think that the transient time is better using the control law of the present paper.

6.7.3 Example 3: Power converter as a switched affine system

A more practical example is borrowed from [9] which also treats the asymptotic stability of a hybrid limit cycle. It is well known that power converters can be modeled as switched affine systems by considering electric variables as the continuous states and the switching signal reflecting the positions of the power switches as the discrete-events. Hence, considering the DC-DC three-cells converter depicted in Figure 6.4, the state vector $x(t)$ gathers the capacitors voltages $v_1(t)$ and $v_2(t)$ and the load current $i_0(t)$. The different modes are derived from the combination of the cell switches as presented in Table 6.1b and so are the system matrices, defined as follows

$$F_i = \begin{bmatrix} 0 & 0 & \frac{u_2 - u_1}{C_1} \\ 0 & 0 & \frac{u_3 - u_2}{C_2} \\ \frac{u_1 - u_2}{L} & \frac{u_1 - u_3}{L} & \frac{-R}{L} \end{bmatrix}, \quad g_i = \begin{bmatrix} 0 \\ 0 \\ \frac{V_{dc}u_3}{L} \end{bmatrix}, \quad \forall i \in \mathbb{K} \quad (6.44)$$

In the search of candidate cycles, it is possible to consider algorithms such as sieves and take into consideration the technological constraint of the multicellular converter: the adjacency condition, *i.e.* only one switch can take place at each transition. In the consecutive papers [8, 9], the authors detail with a lot of specificity the different desired cyclic behaviors around the reference $x_d = \left[V_{dc}/3 \quad 2V_{dc}/3 \quad I_{ref} \right]^T$ for the multilevel power converter considered while we only evaluate the cycles thanks to the cost function (6.40). However, the authors from [9] can only guarantee the local asymptotic stabilization of system (6.10), (6.44) to a predefined limit cycle with the discrete signal sequence $\nu_0 = \left[1 \quad 2 \quad 1 \quad 3 \quad 1 \quad 5 \right]^T$, studied in [8]. The method proposed in the present chapter has been applied to this power converter. Using the sequence ν_0 , we have been able to find solutions to the LMI problem (6.25) which confirmed us that there exists a

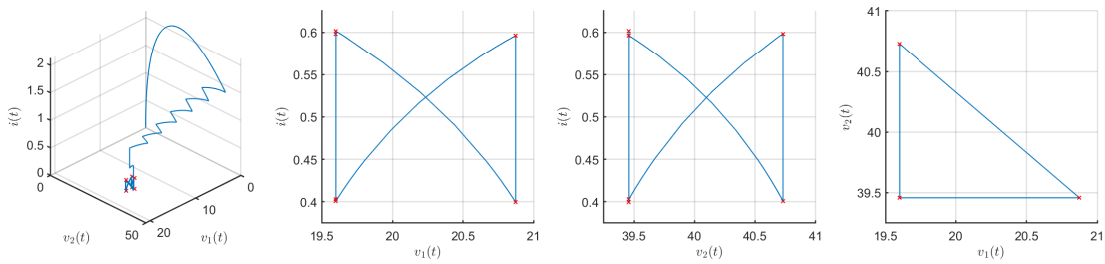

Figure 6.5: On the last three columns, from left to right, are figures illustrating the limit cycle where the system converges. On the first figure on the left is represented the global view of the state evolution in a phase space. In each column, the blue line represents the evolution of the state while the red crosses represent the point of the state limit cycle associated to the cycle ν_0 (Example 3).

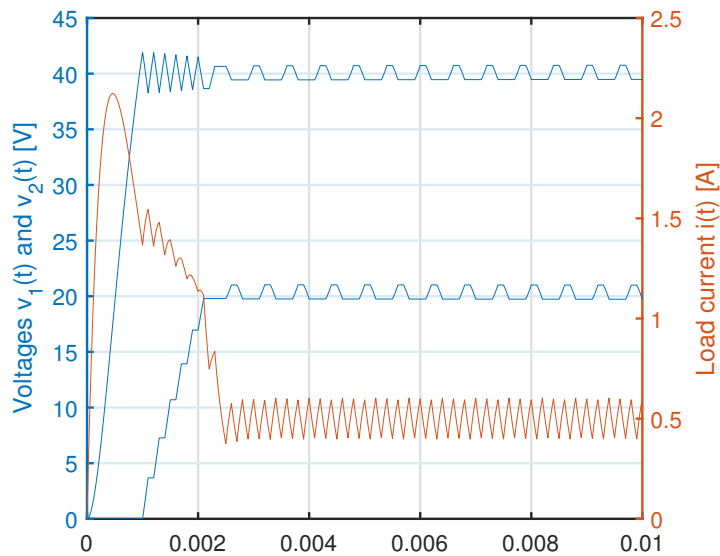

Figure 6.6: State evolution function of the time (Example 3).

solution to (6.21), *i.e.* the state limit cycle associated to ν_0 . On Figure 6.5, it is possible to observe the global stabilization to the limit cycle associated to ν_0 in the phase space. The same simulation is illustrated on Figure 6.6 with a different view.

6.8 Conclusion

Throughout this chapter, the stabilization to a limit cycle for continuous-time switched affine systems is provided. Although the main result seems to be a direct derivation of Theorem 4.2, it requests the use of a new Lyapunov function to perform the stabilization analysis. In addition, the knowledge of the complete state limit cycle (*i.e.* in continuous-time) allows the designer to consider more complex cost functions to reduce the shattering effect for instance; at this stage, the cost functions only depend on the discrete state limit cycle. On another side, compared to recent literature, the design of the global stabilizing switching control law (6.27) is based on simple LMI conditions which are already known in the literature on periodic (linear) system.

Parameters	V_{dc}	C_1, C_2	L	R	I_{ref}
Values	60V	40 μ F	5mH	20 Ω	0.6A

(a) DC-DC three-cells converter parameters

i	1	2	3	4	5	6	7	8
u_1	0	1	0	1	0	1	0	1
u_2	0	0	1	1	0	0	1	1
u_3	0	0	0	0	1	1	1	1

(b) Values u_1 , u_2 and u_3 for each mode i

Table 6.1: Converter parameters and switching states (Example 3).

7

Conclusion & Perspectives

7.1 General conclusion

This thesis has considered the stabilization of switched affine systems governed by a periodic time-triggered switched control law. A special attention has been paid on the characterization of the set where the system trajectories converge to in steady state and has led to the notion of hybrid limit cycle. This work was organized in six chapters and the following contributions were obtained.

- The first chapter served as an introduction motivated by an example from Electronics of DC-DC converters, which can be modeled as switched affine systems. It dealt with a presentation of different frameworks frequently seen in the literature on switched systems and the particular case of switched affine systems in discrete-time was detailed to highlight the existent problems. This chapter ended on a formal problem statement and an overview of the thesis organization.
- The second chapter is the first contributing one. It focused on switched affine systems written in discrete-time and introduced the new class of control Lyapunov functions which is used in the remaining chapters on stabilization: Chapters 4 to 6. By characterizing the invariant set for the closed-loop system as the union of (possibly disjoint) subsets, it has permitted to considerably reduce the size of the so-called attractor compared to the existing literature at the early stage of the PhD. This chapter could be seen as a step toward the characterization of periodic solutions, giving rise to the definition of hybrid limit cycle given in the next chapter.
- Chapter 3 set the basis on limit cycles, first with some literature on the subject and then, with definitions and notions related to limit cycles. The first case of study is concerned with the case of the discrete-time switched affine systems and thanks to the existing literature on discrete-time periodic systems, conditions to the existence of periodic solutions has been derived. These conditions were essential to the main objective of this manuscript which is to characterize as accurately as possible the attractor of the closed-loop system. This characterization appears to be optimal when the attractor is described by a trajectory.
- The two following chapters focused on the design of stabilizing switching control law for discrete-time switched affine systems: in the nominal case in Chapter 4,

and in the uncertain case in Chapter 5. In addition to the stabilization theorems, several comments were made about the recent literature to propose deep discussions and comparisons with the proposed results. Each chapter included a section on the optimal selection of a cycle and illustrations of the theoretical results on numerical examples.

The last chapter introduced the hybrid dynamical systems framework and resumed the result of Chapters 3 and 4 to adapt it to the given formalism. The main result of this chapter was especially interesting since the design of the switching control law is based on the solution to an LMI problem, hence solvable by most of the existent solver. It results from this contribution the stabilization of sampled-data switched affine systems (within the hybrid dynamical systems framework) to a continuous and closed isolated trajectory.

As a conclusion, we can say that the consideration of limit cycle as asymptotic behavior for switched affine system was highly relevant in the case of periodic sampled-data switching control law. Together with the optimal selection of a cycle, this method outperforms any practical stabilization, which are ultimately more conservative.

7.2 Perspectives

The results obtained in the previous chapters show that the consideration of hybrid limit cycles is promising in practical context where the switching control law is constraint by the sampling. There are still open questions and new challenges left for future research in this domain. The following subsections give a flavor of what can be investigated at short and long terms.

7.2.1 Aperiodic timer-triggered control and uncertain systems

In Chapter 6, we designed a stabilizing switching control law for sampled-data switched affine systems. The idea is now to proceed to the design of the switching rule for such systems, but in the case where the matrices are assumed to be unknown and/or time-varying such it has been considered in Chapter 5 for discrete-time switched affine systems. Another interesting aspects is related to the problem of aperiodic sampled-data systems. This problem has been widely studied in the context of the usual class of linear systems [27, 46, 60, 74] to cite only few. This problem refers to the problem of relaxing the jump set of the hybrid model and allowing the sampling interval to be not constant over the simulations.

In the context of aperiodic sampled-data systems, this problem has already been studied for instance in [61], where a solution to the practical stabilization of aperiodic sampled-data switched affine systems has been provided. Following the ideas presented in Chapter 5, the notion of *robust limit cycles* seems to be the relevant direction for future research. Of course, this notion has to be adapted again, in this context of hybrid dynamical systems. The trajectory of the system in steady state should belong to a set looking like a tube: particular case of set of points at a constant distance to a simple

curve. Table 7.1 resumes the different attractors considered in Chapter 4 to 6 and draws the possible structure and expressions of attractors for sampled-data uncertain switched affine systems.

	Discrete-time case	Hybrid case
Nominal case	$\mathcal{A}_\nu = \bigcup_{i \in \mathcal{D}_\nu} \{ \rho_i \}$	$\mathcal{A}_\nu = \bigcup_{i \in \mathcal{D}_\nu} \rho(\tau, i) \times \mathcal{D}_\nu \times [0, T_s]$
Uncertain case	$\mathcal{S}_\nu = \bigcup_{i \in \mathcal{D}_\nu} \mathcal{E}(W_i^{-1}, \zeta_i)$	$\mathcal{S}_\nu = \bigcup_{i \in \mathcal{D}_\nu} \mathcal{E}_{\mathcal{T}}(\mathbb{W}_i^{-1}(\tau), \zeta(\tau, i)) \times \mathcal{D}_\nu \times [0, T_s]$

Table 7.1: Expressions of the attractors obtained in various cases.

In Table 7.1, the notation $\mathcal{E}(W_i^{-1}, \zeta_i)$ designates the ellipsoid defined by

$$\mathcal{E}(W_i^{-1}, \zeta_i) = \left\{ x \in \mathbb{R}^n, i \in \mathcal{D}_\nu \mid (x - \zeta_i)^\top W_i^{-1} (x - \zeta_i) \leq 1 \right\},$$

and $\mathcal{E}_{\mathcal{T}}(\mathbb{W}_i^{-1}(\tau), \zeta(\tau, i))$ denotes an elliptical tube, a set of points at a distance from the given/designed curve $\zeta(\tau, i)$ determined by the following expression

$$\mathcal{E}_{\mathcal{T}}(\mathbb{W}_i^{-1}(\tau), \zeta(\tau, i)) = \left\{ x \in \mathbb{R}^n, i \in \mathcal{D}_\nu \mid (x - \zeta(\tau, i))^\top \mathbb{W}_i^{-1}(\tau) (x - \zeta(\tau, i)) \leq 1 \right\}.$$

The main issue in this context is related to the construction of the parameters of these ellipsoids, i.e. $\mathbb{W}_i^{-1}(\tau)$ and $\zeta(\tau, i)$. These expressions first suggest that the parameters are timer-dependent. In the discrete-time case, the numerical evaluations of W_i and ζ_i were performed through the resolution of an LMI problem. Based on a Sum of Square formulation [76, 80], following the contributions in [20, 21] could provide a possible solution to these problems, where the resulting parameters would be expressed as polynomial expressions on τ .

7.2.2 Aperiodic event-triggered control:

Following the same idea of introducing aperiodicity in the control implementation, another popular topic concerns the problem of event-triggered control [56]. The basic idea is to consider that the sampling instants become an additional degree of freedom to the controller. In the context of switched affine systems, the controller must not only decide which mode to be selected but also the duration of the interval in which the mode has to stay still. A first contribution has been provided in this direction [5]. Therefore extending the contributions of the manuscript (especially of Chapter 6) would represent an interesting contribution. Nevertheless, the main difficulty should be to determine the existence of hybrid limit cycle now that the periodic literature can no longer help.

7.2.3 Synchronization of multiple switched affine systems

Over the last few decades, problems of consensus and synchronization in multi-agent systems have aroused a great deal of interest in the systems and control community,

mainly motivated by a wide range of applications in physics, biology and engineering [26]. The nature of these problems is to reach an agreement collectively about some quantity of interest. It is possible to find in the literature works on nonlinear multi-agent systems [70, 101] or studies on robust synchronization guarantees [30]. However, most of the existing works have set aside nonlinear systems with switching topology, yet relevant in the case of microgrid where agents can represent the electronic power converters [1, 31, 73]. Hence, during my PhD, we tackled this problem by means of centralized switching control law and resulted to the conference paper [88]. This is presented as follows.

Consider a group of $|\mathcal{N}|$ ¹ homogeneous switched systems where each agent $\ell \in \mathcal{N}$ follows the dynamic given by

$$\begin{cases} x_\ell(k+1) &= A_{\sigma_\ell(k)}x_\ell(k) + b_{\sigma_\ell(k)}, & k \in \mathbb{N}, \forall \ell \in \mathcal{N}, \\ \sigma_\ell(k) &\in u(k), \end{cases} \quad (7.1)$$

A priori, each agent has its own switching rule $\sigma_\ell(k)$ but in [88], it has been decided to consider a centralized control law and therefore, that all agents are connected with all other. It offers an access to each other states and allows to simplify the switching control law as a global switching control law, *i.e.* the same active mode for all agent. A compact representation of such multi-agent systems can be defined with an extended state vector $\mathbf{x}(k) = [x_1(k) \ \dots \ x_{|\mathcal{N}|}(k)]^\top \in \mathbb{R}^{n|\mathcal{N}|}$. It yields to the following dynamic

$$\mathbf{x}(k+1) = \mathbf{A}_{\sigma(k)}\mathbf{x}(k) + \mathbf{B}_{\sigma(k)}, \quad (7.2)$$

where the matrices $\mathbf{A}_{\sigma(k)}$ and $\mathbf{B}_{\sigma(k)}$ of system (7.2) are given by

$$\mathbf{A}_{\sigma(k)} = I_{|\mathcal{N}|} \otimes A_{\sigma(k)} \quad \text{and} \quad \mathbf{B}_{\sigma(k)} = \mathbf{1}_{|\mathcal{N}|} \otimes b_{\sigma(k)}. \quad (7.3)$$

Considering the multi-agent switched affine system (7.2)-(7.3), we designed two centralized control laws introduced in the following theorem which both offer stabilizability of the system to the attractor related to the state limit cycle, solution to the following equation²

$$\rho = (I_{nN_\nu} - \mathbf{A}_\nu)^{-1} \mathbf{B}_\nu, \quad (7.4)$$

Theorem 7.1: [88, Theorems 3 and 4]

For a given limit cycle composed of $\nu \in \mathfrak{C}$, assume there exist P_i in \mathbb{S}^n for $i \in \mathfrak{D}_\nu$ solution to

$$P_i \succ 0, \quad A_{\nu^{(i)}}^\top P_{[i+1]_\nu} A_{\nu^{(i)}} - P_i \prec 0, \quad \forall i \in \mathfrak{D}_\nu = \{1, \dots, N_\nu\}. \quad (7.5)$$

Then, the following statements hold

- (i) Eq. (7.4) admits a unique solution ρ , defining the limit cycle.

¹ $|\mathcal{N}|$ denotes the cardinality of the set \mathcal{N}

²Consider here the same notations as the ones given in Chapter 4

(ii) Attractor

$$\mathcal{A}_\nu := \bigcup_{i \in \mathfrak{D}_\nu} \{\mathbf{1}_{|\mathcal{N}|} \otimes \rho_i\}$$

is globally exponentially stable for system (7.2)–(7.3) and, consequently, the agents are synchronized, i.e.

$$\lim_{k \rightarrow +\infty} \|x_\ell(k) - x_{\ell'}(k)\| = 0, \quad \forall (\ell, \ell') \in \mathcal{N}$$

thanks to either

- the centralized switching control law

$$u(\mathbf{x}(k)) = \left\{ \nu(\theta), \theta \in \underset{i \in \mathfrak{D}_\nu}{\operatorname{argmin}} (\mathbf{x}(k) - \boldsymbol{\rho}_i)^\top \mathbf{P}_i (\mathbf{x}(k) - \boldsymbol{\rho}_i) \right\} \subset \mathbb{K}, \quad (7.6)$$

where $\boldsymbol{\rho}_i = \mathbf{1}_{|\mathcal{N}|} \otimes \rho_i$ and $\mathbf{P}_i = I_{|\mathcal{N}|} \otimes P_i$ for all $i \in \mathcal{N}$,

or

- under the additional condition that, if equation $\rho_i = \rho_j$ holds for any i, j in \mathfrak{D}_ν , it implies that $i = j$, then the centralized switching control law

$$u(\mathbf{x}(k)) = \left\{ \nu(\theta), \theta \in \underset{i \in \mathfrak{D}_\nu}{\operatorname{argmin}} (\bar{\mathbf{x}}(k) - \rho_i)^\top P_i (\bar{\mathbf{x}}(k) - \rho_i) \right\} \subset \mathbb{K}, \quad (7.7)$$

where $\bar{\mathbf{x}}(k) = \frac{1}{|\mathcal{N}|} (\mathbf{1}_{|\mathcal{N}|} \otimes I_n)^\top \mathbf{x}(k)$ denotes the mean of $\mathbf{x}(k)$

This work can be seen as a first step on switched affine multi-agent systems stabilization paving the way for further study on distributed control for synchronization. The natural extension would consist in relaxing the assumption on the completeness of the graph, which was central in [88], and would require additional investigations to be relaxed.

7.2.4 Towards the implementation on electronic devices

While the manuscript started with an example of application, the proposed contributions are mostly theoretical and have been evaluated on academic examples. No experiments have taken place. A relevant perspective could be to implement the controls obtained in this thesis and to confront the theoretical results.



Useful properties on matrix inequalities

A.1 Schur complement

Definition A.1: Schur complement

Consider the matrix

$$M = \begin{bmatrix} A & B \\ C & D \end{bmatrix}$$

where the elements A , B , C and D are submatrices belonging respectively to $\mathbb{R}^{n \times n}$, $\mathbb{R}^{n \times m}$, $\mathbb{R}^{m \times n}$ and $\mathbb{R}^{m \times m}$. If the matrix A is non-singular, then we can define the Schur complement of A in M as

$$S := D - C A^{-1} B$$

We can also define the Schur complement of D in M if D is invertible. Following from this definition, an helpful property on the computation of the determinant can be given. For A non-singular, we have:

$$\det(M) = \det(A) \det(D - C A^{-1} B).$$

At multiple occasions, the following lemma is used in the manuscript to convert nonlinear (convex) inequalities to linear matrix inequalities [18, Section 2.1].

Lemma A.1: Schur complement lemma [18]

Consider the symmetric matrix

$$M = \begin{bmatrix} A & B \\ B^\top & D \end{bmatrix},$$

where A invertible, then the following statements are equivalent^a:

1. $M \prec 0$
2. $A \prec 0$ and $D - B^\top A^{-1} B \prec 0$.

^aThis formula stays the same if \prec becomes \succ .

A.2 S-procedure

Another result frequently used in this manuscript is the application of the S-procedure. It considers quadratic functions on a vector variable $x \in \mathbb{R}^n$ as $F(x) = x^\top Qx + 2c^\top x + d$ with $Q \in \mathbb{S}^n$, $c \in \mathbb{R}^n$ and $d \in \mathbb{R}$. The S-procedure is usually stated in the following form.

Lemma A.2: S-procedure lemma [18]

Consider quadratic functions $F_i : \mathbb{R}^n \mapsto \mathbb{R}$, $i \in \{0, \dots, p\}$ with $p \in \mathbb{N}$. The implication

$$F_i(x) \geq 0, i \in \{1, \dots, p\}, \implies F_0(x) \geq 0, \forall x \in \mathbb{R}^n \quad (\text{A.1})$$

holds if there exist $\tau_i \geq 0$, $i \in \{0, \dots, p\}$ such that

$$F_0(x) - \sum_{i=1}^p \tau_i F_i(x) \geq 0, \forall x \in \mathbb{R}^n. \quad (\text{A.2})$$

It is a nontrivial fact that when $p = 1$, the converse holds, provided that there is some x_0 such that $F_1(x_0) > 0$.

Example from [17] (Ellipsoid containment): An ellipsoid $\mathcal{E} \subset \mathbb{R}^n$ with nonempty interior can be represented as the sublevel set of a quadratic function,

$$\mathcal{E} = \{x \mid x^\top Qx + 2c^\top x + d \leq 0\}, \quad (\text{A.3})$$

where $Q \in \mathbb{S}^n$, $Q \succ 0$ and $d - c^\top Q^{-1}c \prec 0$. Suppose $\tilde{\mathcal{E}}$ is another ellipsoid with similar representation,

$$\tilde{\mathcal{E}} = \{x \mid x^\top \tilde{Q}x + 2\tilde{c}^\top x + \tilde{d} \leq 0\}, \quad (\text{A.4})$$

where $\tilde{Q} \in \mathbb{S}^n$, $\tilde{Q} \succ 0$ and $\tilde{d} - \tilde{c}^\top \tilde{Q}^{-1}\tilde{c} \prec 0$. By the S-procedure, we see that $\mathcal{E} \subseteq \tilde{\mathcal{E}}$ if and only if there exists a $\lambda > 0$ such that

$$\begin{bmatrix} \tilde{Q} & \tilde{c} \\ \tilde{c}^\top & \tilde{d} \end{bmatrix} \preceq \lambda \begin{bmatrix} Q & c \\ c^\top & d \end{bmatrix}. \quad (\text{A.5})$$

The application of Lemma A.2 as well as the precedent example can be seen in Section 5.4 of this manuscript.

B

Appendix to Chapter 3

B.1 Details on the monodromy matrix

We consider the following model of a discrete switching linear system

$$\begin{cases} x(k+1) = A_{\sigma(k)}x(k), & k \in \mathbb{N} \\ \sigma(k) \in \mathbb{K} \\ x(0) \in \mathbb{R}^n, \end{cases} \quad (\text{B.1})$$

where the matrices $A_i \in \mathbb{R}^{n \times n}$ are considered to be known and constant for all $i \in \mathbb{K} := \{1, \dots, K\}$ and the switching signal $\sigma(k)$ is periodic, *i.e.* we have for a given cycle $\nu \in \mathfrak{C}$ as defined in Definition 3.5 on page 39 the following relation

$$\sigma(k) = \nu(k), \quad \forall k \in \mathbb{N}, \quad (\text{B.2})$$

where N_ν is the period of ν so that

$$\nu(\ell + N_\nu) = \nu(\ell), \quad \forall \ell \in \mathbb{N}.$$

Hence, system (B.1) becomes a periodic system:

$$\begin{cases} x(k+1) = A_{\nu(k)}x(k), & k \in \mathbb{N} \\ x(k+N_\nu) = x(k), & \forall k \in \mathbb{N} \\ x(0) \in \mathbb{R}^n, \end{cases} \quad (\text{B.3})$$

and taking [13, Section 2.4] as reference¹, the monodromy matrix is the transition matrix over one period:

- Transition matrix:

$$\Psi_\nu(k, \kappa) = \begin{cases} I_n & k = \kappa, \\ A_{\nu(k-1)}A_{\nu(k-2)} \cdots A_{\nu(\kappa)} & k > \kappa, \end{cases}$$

- Monodromy matrix:

$$\Phi_{\nu(k)} = \Psi_\nu(k + N_\nu, k).$$

¹Note that the notations here follow the ones given in the manuscript and not the book [13]

A lot of interesting properties are given in [13] as for instance the invariance of the characteristic multipliers at time ℓ , namely, the eigenvalues of the monodromy matrix $\Phi_{\nu(\ell)}$ but the focus made here is on the relation between the characteristic multipliers and the eigenvalues of the cyclic augmented matrix \mathbf{A}_{ν} . As a reminder, this matrix is defined as follows

$$\mathbf{A}_{\nu} = \begin{bmatrix} 0 & \dots & 0 & A_{\nu(N_{\nu})} \\ A_{\nu(1)} & \ddots & 0 & 0 \\ \vdots & \ddots & \ddots & \vdots \\ 0 & \dots & A_{\nu(N_{\nu}-1)} & 0 \end{bmatrix}.$$

In the proof of Lemma 3.1, we referred the reader to [77, Lemma 4] in order to use the following relation

$$\det(zI_{nN_{\nu}} - \mathbf{A}_{\nu}) = \det(z^{N_{\nu}}I_n - \Phi_{\nu(0)}).$$

This equation is an important step to conclude on the existence conditions but, unfortunately, the proof of [77, Lemma 4] only gives an indication of the calculation to be done, it is not very instructive. Let us then provide some insights to the development, to this end, let us consider an example where $N_{\nu} = 4$. Starting from

$$\det(zI_{4n} - \mathbf{A}_{\nu}) = \det \left(\begin{bmatrix} zI_n & 0 & 0 & -A_{\nu(4)} \\ -A_{\nu(1)} & zI_n & 0 & 0 \\ 0 & -A_{\nu(2)} & zI_n & 0 \\ 0 & 0 & -A_{\nu(3)} & zI_n \end{bmatrix} \right),$$

we can benefit of the Schur complement properties to determine the determinant of this block matrix. It yields to

$$\begin{aligned} \det(zI_{4n} - \mathbf{A}_{\nu}) &= \det(zI_n) \det \left(\begin{bmatrix} zI_n & 0 & 0 \\ -A_{\nu(2)} & zI_n & 0 \\ 0 & -A_{\nu(3)} & zI_n \end{bmatrix} - \begin{bmatrix} -A_{\nu(1)} \\ 0 \\ 0 \end{bmatrix} [zI_n]^{-1} \begin{bmatrix} 0 \\ 0 \\ -A_{\nu(4)}^{\top} \end{bmatrix}^{\top} \right), \\ &= \det(zI_n) \det \left(\begin{bmatrix} zI_n & 0 & -\frac{1}{z}A_{\nu(1)}A_{\nu(4)} \\ -A_{\nu(2)} & zI_n & 0 \\ 0 & -A_{\nu(3)} & zI_n \end{bmatrix} \right), \\ &= \det(zI_n)^2 \det \left(\begin{bmatrix} zI_n & 0 \\ -A_{\nu(3)} & zI_n \end{bmatrix} - \begin{bmatrix} -A_{\nu(2)} \\ 0 \end{bmatrix} [zI_n]^{-1} \begin{bmatrix} 0 & -\frac{1}{z}A_{\nu(1)}A_{\nu(4)} \end{bmatrix} \right), \\ &= \det(zI_n)^2 \det \left(\begin{bmatrix} zI_n & -\frac{1}{z^2}A_{\nu(2)}A_{\nu(1)}A_{\nu(4)} \\ -A_{\nu(3)} & zI_n \end{bmatrix} \right), \\ &= \det(zI_n)^3 \det \left(zI_n - \frac{1}{z^3}A_{\nu(3)}A_{\nu(2)}A_{\nu(1)}A_{\nu(4)} \right), \\ &= \det \left(z^4I_n - A_{\nu(3)}A_{\nu(2)}A_{\nu(1)}A_{\nu(4)} \right) = \det \left(z^4I_n - \Phi_{\nu(0)} \right). \end{aligned}$$

APPENDIX B.

As the precedent development shows, the computation of the determinant of the cyclic augmented matrix \mathbf{A}_ν can be done iteratively, even for cycle of greater period.

Bibliography

- [1] Carolina Albea. Hybrid dynamical control based on consensus algorithms for current sharing in DC-bus microgrids. *Nonlinear Analysis: Hybrid Systems*, 39:100972, 2021.
- [2] Carolina Albea, Germain Garcia, Sabrina Hadjeras, W.P.Maurice H. Heemels, and Luca Zaccarian. Practical stabilisation of switched affine systems with dwell-time guarantees. *IEEE Transactions on Automatic Control*, 64(11):4811–4817, 2019.
- [3] Carolina Albea, Germain Garcia, and Luca Zaccarian. Hybrid dynamic modeling and control of switched affine systems: Application to DC-DC converters. In *54th IEEE Conference on Decision and Control (CDC)*, pages 2264–2269, 2015.
- [4] Carolina Albea, Francisco Gordillo, and Carlos Canudas-de Wit. Adaptive control design for a boost inverter. *Control Engineering Practice*, 19(1):32–44, 2011.
- [5] Carolina Albea and Alexandre Seuret. Time-triggered and event-triggered control of switched affine systems via a hybrid dynamical approach. *Nonlinear Analysis: Hybrid Systems*, 41:101039, 2021.
- [6] Carolina Albea, Antonio Ventosa-Cutillas, Alexandre Seuret, and Francisco Gordillo. Robust switching control design for uncertain discrete-time switched affine systems. *International Journal of Robust and Nonlinear Control*, 30(17):7089–7102, 2020.
- [7] Gaetan Beneux, Pierre Riedinger, Jamal Daafouz, and Louis Grimaud. Adaptive stabilization of switched affine systems with unknown equilibrium points: Application to power converters. *Automatica*, 99:82–91, 2019.
- [8] Mohammed Benmiloud, Atallah Benalia, Michael Defoort, and Mohamed Djemai. On the limit cycle stabilization of a DC/DC three-cell converter. *Control Engineering Practice*, 49:29–41, 2016.
- [9] Mohammed Benmiloud, Atallah Benalia, Mohamed Djemai, and Michael Defoort. On the local stabilization of hybrid limit cycles in switched affine systems. *IEEE Transactions on Automatic Control*, 64(2):841–846, 2019.
- [10] Sergio Bittanti. Deterministic and stochastic linear periodic systems. In *Time Series and Linear Systems*, pages 141–182. Springer, 1986.
- [11] Sergio Bittanti, Paolo Bolzern, and Patrizio Colaneri. Stability analysis of linear periodic systems via the Lyapunov equation. *IFAC Proceedings Volumes*, 17(2):213–216, 1984. 9th IFAC World Congress.
- [12] Sergio Bittanti and Patrizio Colaneri. Analysis of discrete-time linear periodic systems. In *Control and Dynamic Systems*, volume 78, pages 313–339. Elsevier, 1996.

-
- [13] Sergio Bittanti and Patrizio Colaneri. *Periodic Systems*. Springer Science & Business Media, 2009.
- [14] Vincent Blondel and John N. Tsitsiklis. NP-hardness of some linear control design problems. In *Proceedings of 34th IEEE Conference on Decision and Control*, volume 3, pages 2910–2915, 1995.
- [15] Paolo Bolzern and Patrizio Colaneri. The periodic Lyapunov equation. *SIAM Journal on Matrix Analysis and Applications*, 9(4):499–512, 1988.
- [16] Paolo Bolzern and William Spinelli. Quadratic stabilization of a switched affine system about a nonequilibrium point. *Proceedings of the 2004 American Control Conference*, 5:3890–3895, 2004.
- [17] Stephen Boyd, Stephen P Boyd, and Lieven Vandenberghe. *Convex optimization*. Cambridge university press, 2004.
- [18] Stephen Boyd, Laurent El Ghaoui, Eric Feron, and Venkataramanan Balakrishnan. *Linear Matrix Inequalities in System and Control Theory*. SIAM, 1994.
- [19] Michael S. Branicky. Multiple Lyapunov functions and other analysis tools for switched and hybrid systems. *IEEE Transactions on Automatic Control*, 43(4):475–482, 1998.
- [20] Corentin Briat. Stability analysis and stabilization of stochastic linear impulsive, switched and sampled-data systems under dwell-time constraints. *Automatica*, 74:279–287, 2016.
- [21] Corentin Briat and Alexandre Seuret. Affine characterizations of minimal and mode-dependent dwell-times for uncertain linear switched systems. *IEEE Transactions on Automatic Control*, 58(5):1304–1310, 2012.
- [22] Jean Buisson, Pierre-Yves Richard, and Hervé Cormerais. On the stabilisation of switching electrical power converters. In *Hybrid Systems: Computation and Control*, volume 3414 of *Lecture Notes in Computer Science*, pages 184–197. Springer Berlin Heidelberg, 2005.
- [23] Carlos A. C. Gonzaga. *Analyse de stabilité et de performance d’une classe de systèmes non linéaires à commutations en temps discret*. PhD thesis, Université de Lorraine, 2012.
- [24] Carlos A. C. Gonzaga, Marc Jungers, and Jamal Daafouz. Stability analysis of discrete-time Lur’e systems. *Automatica*, 48(9):2277–2283, 2012.
- [25] Chaohong Cai, Rafal Goebel, Ricardo G. Sanfelice, and Andrew R. Teel. *Analysis and Design of Nonlinear Control Systems: In Honor of Alberto Isidori*, chapter Hybrid Systems: Limit Sets and Zero Dynamics with a View Toward Output Regulation, pages 241–261. Springer Berlin Heidelberg, Berlin, Heidelberg, 2008.
- [26] Fei Chen and Wei Ren. On the control of multi-agent systems: A survey. *Foundations and Trends® in Systems and Control*, 6(4):339–499, 2019.

- [27] Tongwen Chen and Bruce A. Francis. Input-output stability of sampled-data systems. *IEEE Transactions on Automatic Control*, 36(1):50–58, 1991.
- [28] Jorge Cortes. Discontinuous dynamical systems. *IEEE Control systems magazine*, 28(3):36–73, 2008.
- [29] Dariusz Czarkowski. 10 - DC-DC converters. In Muhammad H. Rashid, editor, *Power Electronics Handbook (Fourth Edition)*, pages 275–288. Butterworth-Heinemann, fourth edition edition, 2018.
- [30] Laura Dal Col, Sophie Tarbouriech, and Luca Zaccarian. \mathcal{H}_∞ control design for synchronisation of identical linear multi-agent systems. *International Journal of Control*, 91(10):2214–2229, 2018.
- [31] Claudio De Persis, Erik R.A. Weitenberg, and Florian Dörfler. A power consensus algorithm for DC microgrids. *Automatica*, 89:364–375, 2018.
- [32] Carlos E. De Souza and Alexandre Trofino. An LMI approach to stabilization of linear discrete-time periodic systems. *International Journal of Control*, 73(8):696–703, 2000.
- [33] Grace S. Deaecto and José C. Geromel. Stability analysis and control design of discrete-time switched affine systems. *IEEE Transactions on Automatic Control*, 62(8):4058–4065, 2016.
- [34] Grace S. Deaecto, José C. Geromel, Fellipe S. Garcia, and José A. Pomilio. Switched affine systems control design with application to DC-DC converters. *IET Control Theory & Applications*, 4(7):1201–1210, 2010.
- [35] Christopher Edwards and Sarah Spurgeon. *Sliding Mode Control: Theory and Applications*. CRC Press, 1998.
- [36] Lucas N. Egidio, Helder R. Daiha, and Grace S. Deaecto. Global asymptotic stability of limit cycle and $\mathcal{H}_2/\mathcal{H}_\infty$ performance of discrete-time switched affine systems. *Automatica*, 116, 2020.
- [37] Lucas N. Egidio and Grace S. Deaecto. Novel practical stability conditions for discrete-time switched affine systems. *IEEE Transactions on Automatic Control*, 2019.
- [38] Lucas N. Egidio, Grace S. Deaecto, and José C. Geromel. Limit cycle global asymptotic stability of continuous-time switched affine systems. *IFAC-PapersOnLine*, 53(2):6121–6126, 2020. 21th IFAC World Congress.
- [39] Lucas N. Egidio, Grace S. Deaecto, and José C. Geromel. Limit cycle global asymptotic stability of continuous-time switched affine systems. *IFAC-PapersOnLine*, 53(2):6121–6126, 2020. 21st IFAC World Congress.
- [40] Lucas N. Egidio and Anders Hansson. On the search for equilibrium points of switched affine systems. Submitted, 2021.

-
- [41] Hassan Fathabadi. Novel high efficiency DC/DC boost converter for using in photovoltaic systems. *Solar Energy*, 125:22–31, 2016.
- [42] Eric Feron. *Quadratic Stabilizability of Switched Systems via state and output feedback*. Report, Center for Intelligent Control Systems, Laboratory for Information and Decision Systems, MIT, 1996.
- [43] Mirko Fiacchini, Antoine Girard, and Marc Jungers. On the stabilizability of discrete-time switched linear systems: Novel conditions and comparisons. *IEEE Transactions on Automatic Control*, 61(5):1181–1193, 2015.
- [44] David S. Flamm. A new shift-invariant representation for periodic linear systems. *Systems & Control Letters*, 17(1):9–14, 1991.
- [45] Damien Flieller, Pierre Riedinger, and Jean-Paul Louis. Computation and stability of limit cycles in hybrid systems. *Nonlinear Analysis: Theory, Methods & Applications*, 64(2):352–367, 2006.
- [46] Emilia Fridman, Alexandre Seuret, and Jean-Pierre Richard. Robust sampled-data stabilization of linear systems: An input delay approach. *Automatica*, 40(8):1441–1446, 2004.
- [47] José C Geromel and Patrizio Colaneri. Stability and stabilization of continuous-time switched linear systems. *SIAM Journal on Control and Optimization*, 45(5):1915–1930, 2006.
- [48] José C. Geromel and Patrizio Colaneri. Stability and stabilization of discrete time switched systems. *International Journal of Control*, 79(7):719–728, 2006.
- [49] Antoine Girard. Computation and stability analysis of limit cycles in piecewise linear hybrid systems. In *IFAC Conference on Analysis and Design of Hybrid Systems*, volume 36(6), pages 181–186, 2003.
- [50] Rafal Goebel, Ricardo G. Sanfelice, and Andrew R. Teel. *Hybrid Dynamical Systems*. Princeton University Press, 2012.
- [51] Jorge M. Gonçalves. Regions of stability for limit cycles of piecewise linear systems. In *Proceedings of the 42nd IEEE International Conference on Decision and Control*, volume 1, pages 651–656, 2003.
- [52] Michael Grant and Stephen Boyd. CVX: Matlab software for disciplined convex programming, version 2.1. <http://cvxr.com/cvx>, 2014.
- [53] Otomar Hájek. Discontinuous differential equations, i. *Journal of Differential Equations*, 32(2):149–170, 1979.
- [54] Pascal Hauroigne, Pierre Riedinger, and Claude Iung. Switched affine systems using sampled-data controllers: Robust and guaranteed stabilisation. *IEEE Transactions on Automatic Control*, 56(12):2929–2935, 2011.

- [55] W.P. Maurice H. Heemels, Atreyee Kundu, and Jamal Daafouz. On Lyapunov-Metzler inequalities and s-procedure characterizations for the stabilization of switched linear systems. *IEEE Transactions on Automatic Control*, 62(9):4593–4597, 2016.
- [56] W.P.Maurice H. Heemels, Karl H. Johansson, and Paulo Tabuada. An introduction to event-triggered and self-triggered control. In *51st IEEE Conference on Decision and Control (CDC)*, pages 3270–3285. IEEE, 2012.
- [57] João P. Hespanha, Daniel Liberzon, and A. Stephen Morse. Hysteresis-based switching algorithms for supervisory control of uncertain systems. *Automatica*, 39(2):263–272, 2003.
- [58] L. Hetel, J. Daafouz, and C. Iung. Stabilization of arbitrary switched linear systems with unknown time-varying delays. *IEEE Transactions on Automatic Control*, 51(10):1668–1674, 2006.
- [59] Laurentiu Hetel and Emmanuel Bernuau. Local stabilization of switched affine systems. *IEEE Transactions on Automatic Control*, 60(4):1158–1163, 2014.
- [60] Laurentiu Hetel, Christophe Fiter, Hassan Omran, Alexandre Seuret, Emilia Fridman, Jean-Pierre Richard, and Silviu Iulian Niculescu. Recent developments on the stability of systems with aperiodic sampling: An overview. *Automatica*, 76:309–335, 2017.
- [61] Laurentiu Hetel and Emilia Fridman. Robust sampled-data control of switched affine systems. *IEEE Transactions on Automatic Control*, 58(11):2922–2928, 2013.
- [62] Karl H. Johansson, Andrey Baranov, and Karl J. Åström. Limit cycles with chattering in relay feedback systems. In *Proceedings of the 36th IEEE Conference on Decision and Control*, volume 4, pages 3220–3225, 1997.
- [63] Marc Jungers, Francesco Ferrante, and Jérôme Lohéac. Dissipativeness and dissipation of discrete-time switched linear systems. In *2019 IEEE 58th Conference on Decision and Control (CDC)*, pages 5760–5765, 2019.
- [64] Zohra Kader. *Commande et observation des systèmes affines à commutations*. PhD thesis, Lille 1, 2017.
- [65] Zohra Kader, Christophe Fiter, Laurentiu Hetel, and Lotfi Belkoura. Stabilization of switched affine systems with disturbed state-dependent switching laws. *International Journal of Robust and Nonlinear Control*, 28(2):582–595, 2018.
- [66] Hassan K. Khalil and Jessy W. Grizzle. *Nonlinear Systems*, volume 3. Prentice hall Upper Saddle River, NJ, 2002.
- [67] Muhammad Mansoor Khan and Wu Zhi-Ming. A generalized framework for sampled-data model analysis of closed-loop pwm dc-dc converter system. In *IECON'01. 27th Annual Conference of the IEEE Industrial Electronics Society (Cat. No. 37243)*, volume 2, pages 820–825. IEEE, 2001.

-
- [68] Daniel Liberzon. *Switching in Systems and Control*. Springer Science & Business Media, 2003.
- [69] Hai Lin and Panos J. Antsaklis. Stability and stabilizability of switched linear systems: A survey of recent results. *IEEE Transactions on Automatic Control*, 54(2):308–322, 2009.
- [70] Tengfei Liu and Zhong-Ping Jiang. Distributed output-feedback control of nonlinear multi-agent systems. *IEEE Transactions on Automatic Control*, 58(11):2912–2917, 2013.
- [71] Oswaldo Lopez-Santos, Luis Martinez-Salamero, Germain Garcia, Hugo Valderrama-Blavi, and Tomás Sierra-Polanco. Robust sliding-mode control design for a voltage regulated quadratic boost converter. *IEEE Transactions on Power Electronics*, 30(4):2313–2327, 2015.
- [72] Luis Martinez-Salamero, Germain García, Marcos Orellana, Cyril Lahore, Bruno Estibals, Corinne Alonso, and Carlos Eduardo Carrejo. Analysis and design of a sliding-mode strategy for start-up control and voltage regulation in a buck converter. *IET Power Electronics*, 6(1):52–59, 2013.
- [73] Lexuan Meng, Tomislav Dragicevic, Javier Roldán-Pérez, Juan C. Vasquez, and Josep M. Guerrero. Modeling and sensitivity study of consensus algorithm-based distributed hierarchical control for DC microgrids. *IEEE Transactions on Smart Grid*, 7(3):1504–1515, 2015.
- [74] Payam Naghshtabrizi, João P. Hespanha, and Andrew R. Teel. Exponential stability of impulsive systems with application to uncertain sampled-data systems. *Systems & Control Letters*, 57(5):378–385, 2008.
- [75] Carlos Olalla, Ramon Leyva, Abdelali El Aroudi, Pedro Garcés, and Isabelle Queinnec. LMI robust control design for boost PWM converters. *IET Power Electronics*, 3(1):75–85, 2010.
- [76] Antonis Papachristodoulou and Stephen Prajna. A tutorial on Sum of Squares techniques for systems analysis. In *Proceedings of the 2005, American Control Conference*, volume 4, pages 2686–2700. IEEE, 2005.
- [77] B. Park and Erik I. Verriest. Canonical forms on discrete linear periodically time-varying systems and a control application. In *Proceedings of the 28th IEEE Conference on Decision and Control*, volume 2, pages 1220–1225, 1989.
- [78] Stefan Pettersson and Bengt Lennartson. Stabilization of hybrid systems using a min-projection strategy. In *Proceedings of the 2001 American Control Conference*, volume 1, pages 223–228, 2001.
- [79] Alexander Poznyak, Andrey Polyakov, and Vadim Azhmyakov. *Attractive Ellipsoids in Robust Control*. Springer, 2014.

- [80] Stephen Prajna, Antonis Papachristodoulou, and Pablo A. Parrilo. Introducing SOSTOOLS: A general purpose sum of squares programming solver. In *Proceedings of the 41st IEEE Conference on Decision and Control*, volume 1, pages 741–746. IEEE, 2002.
- [81] James A. Rehg and Glenn J. Sartori. *Industrial Electronics*. Pearson Prentice Hall, 2006.
- [82] Marcus Rubensson, Bengt Lennartson, and Stefan Pettersson. Convergence to limit cycles in hybrid systems - An example. *IFAC Proceedings Volumes*, 31(20):683–688, 1998.
- [83] Seth R. Sanders. On limit cycles and the describing function method in periodically switched circuits. *IEEE Transactions on Circuits and Systems I: Fundamental, Theory and Applications*, 40(9):564–572, 1993.
- [84] Matthew Senesky, Gabriel Eirea, and T. John Koo. Hybrid modelling and control of power electronics. In *Hybrid Systems: Computation and Control*, volume 2623 of *Lecture Notes in Computer Science*, pages 450–465. Springer Berlin Heidelberg, 2003.
- [85] Mathias Serieye, Carolina Albea, and Alexandre Seuret. Free-matrices min-projection control for high frequency DC-DC converters. In *IEEE 58th Conference on Decision and Control (CDC)*, pages 2491–2496, 2019.
- [86] Mathias Serieye, Carolina Albea, Alexandre Seuret, and Marc Jungers. Stabilization of switched affine systems via multiple shifted Lyapunov functions. In *21st IFAC World Congress*, volume 53, pages 6133–6138, 2020.
- [87] Mathias Serieye, Carolina Albea, Alexandre Seuret, and Marc Jungers. Robust stabilization to limit cycles of switching discrete-time affine systems using control Lyapunov functions. Under review, 2021.
- [88] Mathias Serieye, Carolina Albea, Alexandre Seuret, and Marc Jungers. Synchronization on a limit cycle of multi-agent systems governed by discrete-time switched affine dynamics. *IFAC-PapersOnLine*, 54(5):295–300, 2021. 7th IFAC Conference on Analysis and Design of Hybrid Systems ADHS 2021.
- [89] Alexandre Seuret, Christophe Prieur, Sophie Tarbouriech, Andrew R. Teel, and Luca Zaccarian. A nonsmooth hybrid invariance principle applied to robust event-triggered design. *IEEE Transactions on Automatic Control*, 64(5):2061–2068, 2018.
- [90] Yuri Shtessel, Christopher Edwards, Leonid Fridman, and Arie Levant. *Sliding Mode Control and Observation*. Springer, 2014.
- [91] Slobodan N. Simic, Shankar Sastry, Karl H. Johansson, and John Lygeros. Hybrid limit cycles and hybrid Poincaré-Bendixson. *IFAC Proceedings Volumes*, 35(1):197–202, 2002.

- [92] Hebertt J. Sira-Ramirez and Ramón Silva-Ortigoza. *Control Design Techniques in Power Electronics Devices*. Springer Science & Business Media, 2006.
- [93] Efstratios Skafidas, Robin J. Evans, Andrey V. Savkin, and Ian R. Petersen. Stability results for switched controller systems. *Automatica*, 35(4):553–564, 1999.
- [94] Jean-Jacques E. Slotine, Weiping Li, et al. *Applied Nonlinear Control*, volume 199. Prentice hall Englewood Cliffs, NJ, 1991.
- [95] Steven H. Strogatz. *Nonlinear Dynamics and Chaos with student solutions manual: With applications to physics, biology, chemistry, and engineering*. CRC press, 2018.
- [96] Thomas A.F. Theunisse, Jun Chai, Ricardo G. Sanfelice, and W.P. Maurice H. Heemels. Robust global stabilization of the DC-DC boost converter via hybrid control. *IEEE Transactions on Circuits and Systems I: Regular Papers*, 62(4):1052–1061, 2015.
- [97] O. Toker and H. Ozbay. On the np-hardness of solving bilinear matrix inequalities and simultaneous stabilization with static output feedback. In *Proceedings of 1995 American Control Conference - ACC'95*, volume 4, pages 2525–2526 vol.4, 1995.
- [98] Vadim Utkin. Sliding mode control of DC/DC converters. *Journal of the Franklin Institute*, 350(8):2146–2165, 2013.
- [99] Jeremy G. VanAntwerp and Richard D. Braatz. A tutorial on linear and bilinear matrix inequalities. *Journal of Process Control*, 10(4):363–385, 2000.
- [100] Erik I. Verriest. The operational transfer function and parameterization of N-periodic systems. In *Proceedings of the 27th IEEE Conference on Decision and Control*, pages 1994–1999. IEEE, 1988.
- [101] Jie Zhang, Ming Lyu, Tianfeng Shen, Lei Liu, and Yuming Bo. Sliding mode control for a class of nonlinear multi-agent system with time delay and uncertainties. *IEEE Transactions on Industrial Electronics*, 65(1):865–875, 2018.